

## **Appendix D – Typical Construction and Preliminary Engineering Drawings**

## **Appendix D-1 – Typical Construction Drawings**

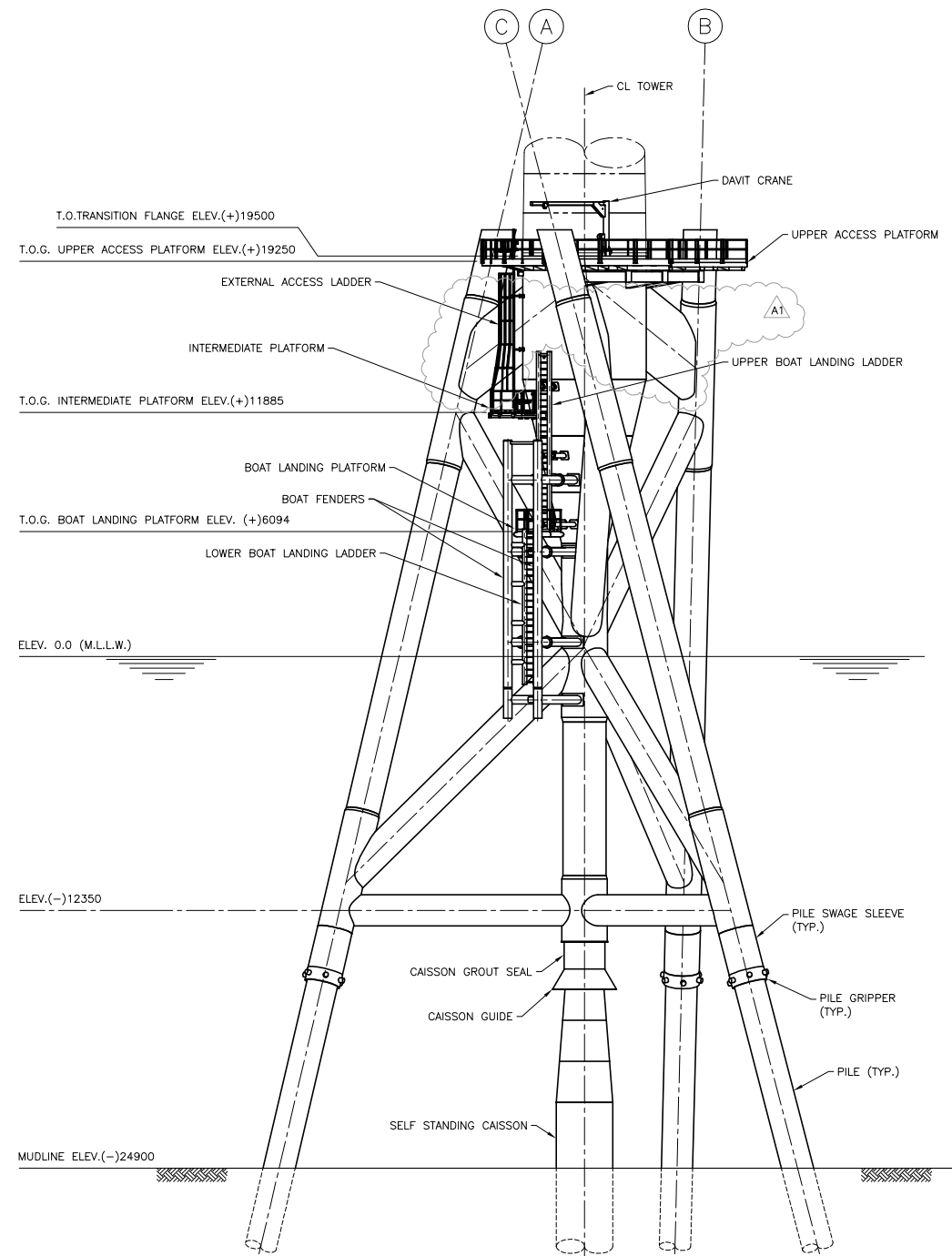



ASSEMBLY ELEVATION LOOKING NORTH  
SCALE: 1:150

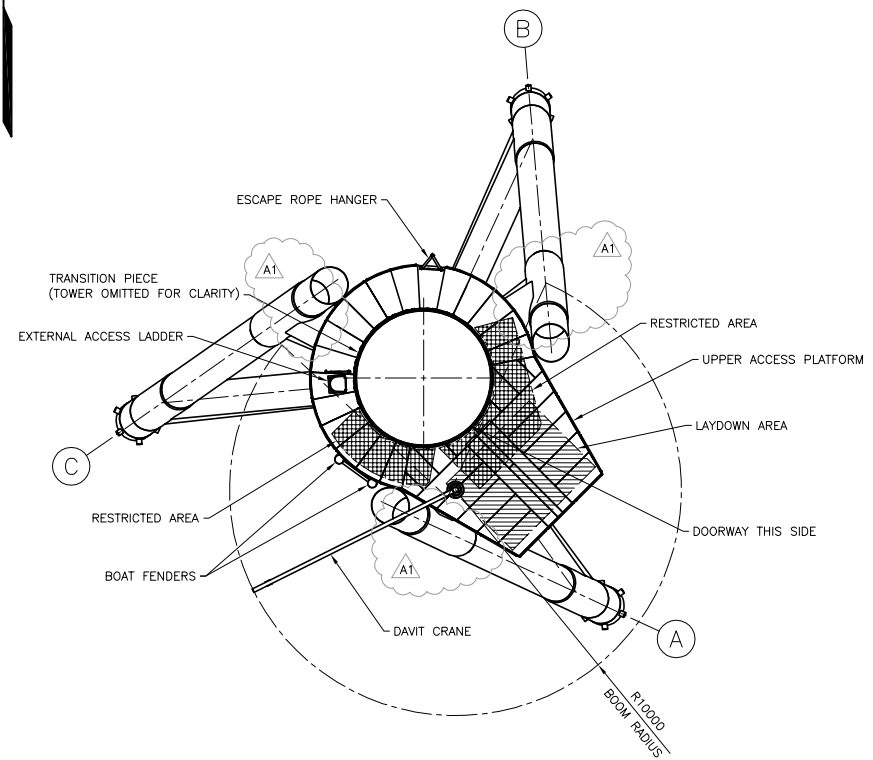

ASSEMBLY PLAN  
SCALE: 1:150

- NOTES:
1. ALL DIMENSIONS ARE IN MILLIMETERS, UNLESS NOTED OTHERWISE.
  2. ALL ELEVATIONS ARE IN MILLIMETERS RELATIVE TO MEAN LOWER LOW WATER (M.L.L.W.) CHART DATUM.
  3. FOR GENERAL NOTES SEE DRAWING 003.
  4. FOR TYPICAL WELDING DETAILS SEE DRAWING 004.

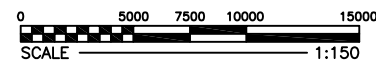

**CONFIDENTIAL INFORMATION**  
**EXCLUSIVE PROPERTY OF KEYSTONE ENGINEERING INC.**  
 U.S. PATENT NUMBERS U.S. 6,763,305, U.S. 7,134,809, U.S. 7,198,453, U.S. 8,444,349 AND U.S. 9,511,940, CANADIAN PATENT NO. 2,476,514 AND 2,567,877 AND EUROPEAN PATENT NO. 1,425,476 (OTHER PATENTS PENDING)

**PRELIMINARY**  
 DOCUMENTS ARE NOT TO BE USED FOR CONSTRUCTION, BIDDING, RECORDATION, CONVEYANCE, SALES, OR AS THE BASIS FOR THE ISSUANCE OF A PERMIT.

NO.	BY	REVISION	DATE	CHK'D.	APP'D.
A1	FJF	ISSUED FOR INFORMATION ONLY	9/14		
A	FJF	ISSUED FOR INFORMATION ONLY	7/14		

**UNCHECKED**

REVIEWED BY:	PREPARED BY:
PROJECT MANAGER DATE	F FALGOUT 07JUN14
LEAD ENGINEER DATE	DESIGNER/DRAWER DATE
DRAFTING SUPERVISOR DATE	CHECKER DATE
LEAD DESIGNER DATE	PROJECT NUMBER:
	6057A14

<b>Keystone ENGINEERING INC.</b>		<b>Dominion</b>	
VIRGINIA OFFSHORE WIND TECHNOLOGY ADVANCEMENT PROJECT (VOWTAP)		VIRGINIA OFFSHORE WIND TECHNOLOGY ADVANCEMENT PROJECT (VOWTAP)	
6MW 24.9M W.D. (M.L.L.W.) IBGS FOUNDATION ASSEMBLY ELEVATION & PLAN		6MW 24.9M W.D. (M.L.L.W.) IBGS FOUNDATION ASSEMBLY ELEVATION & PLAN	
APPROVAL:	SCALE:	NOTED	REV. A1
			A-002

'LIMITED RIGHTS DATA'

Appendix D-1, Figure 1

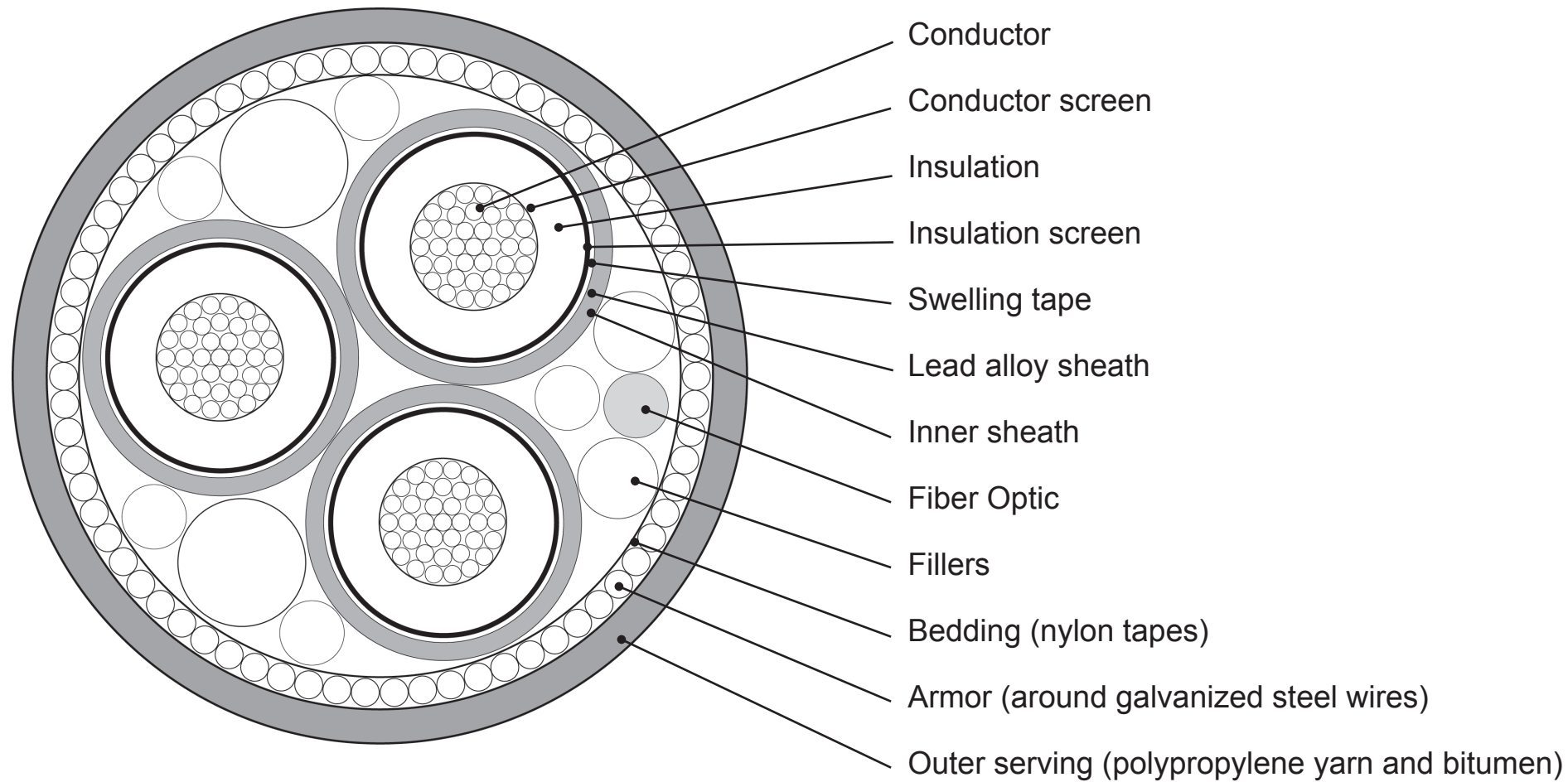

**TETRA TECH**

**Typical 34.5-kV Submarine Transmission Cable**



**Dominion**

Virginia Offshore Wind Technology Advancement Project  
Research Activities Plan

**Appendix D-1, Figure 2**

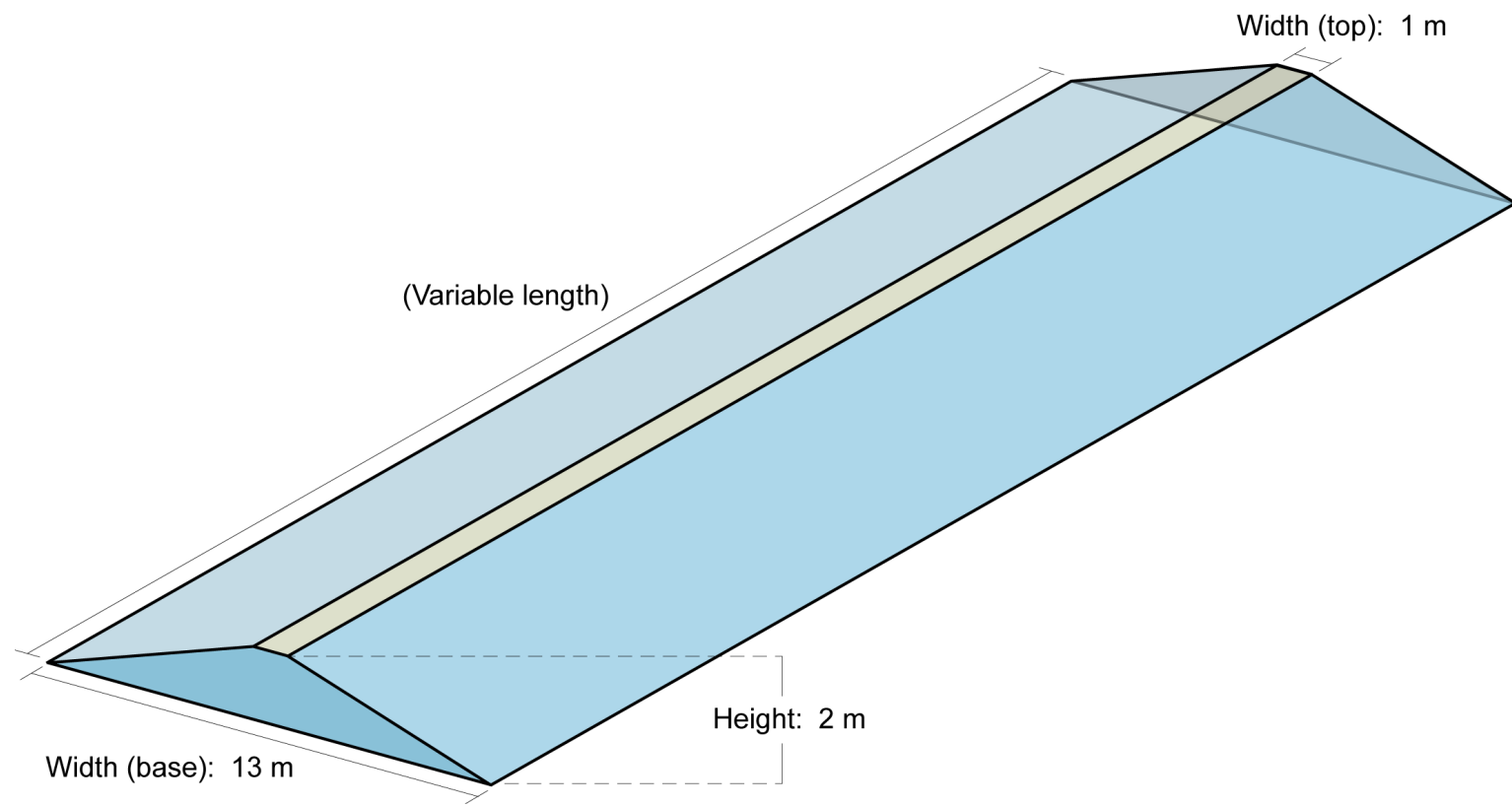

Representative Rock Berm

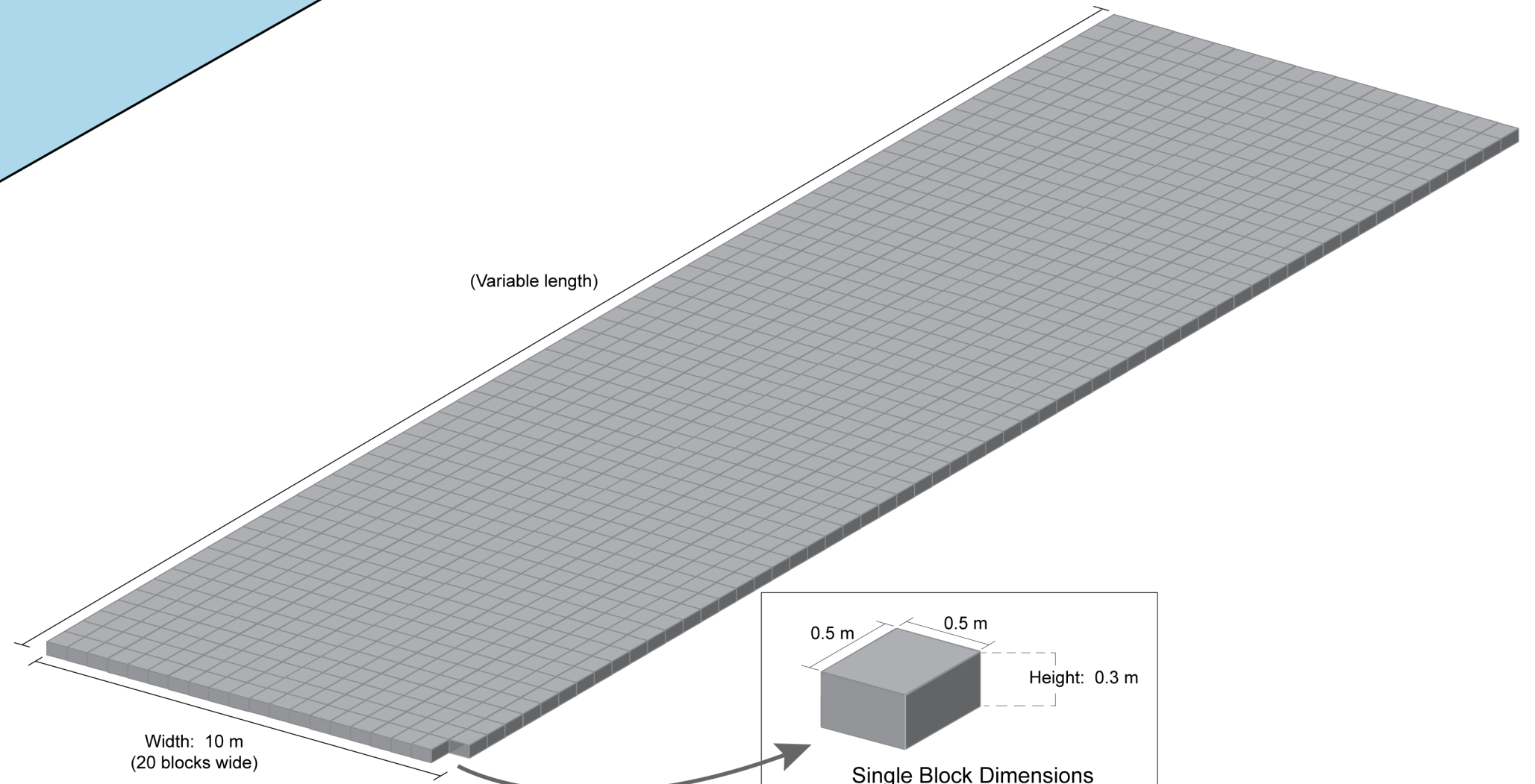

Representative Concrete Mattress

Note: Drawing is not to scale



Representative Schematics of Proposed Additional Cable Protection



Virginia Offshore Wind Technology Advancement Project  
Research Activities Plan

Appendix D-1, Figure 3

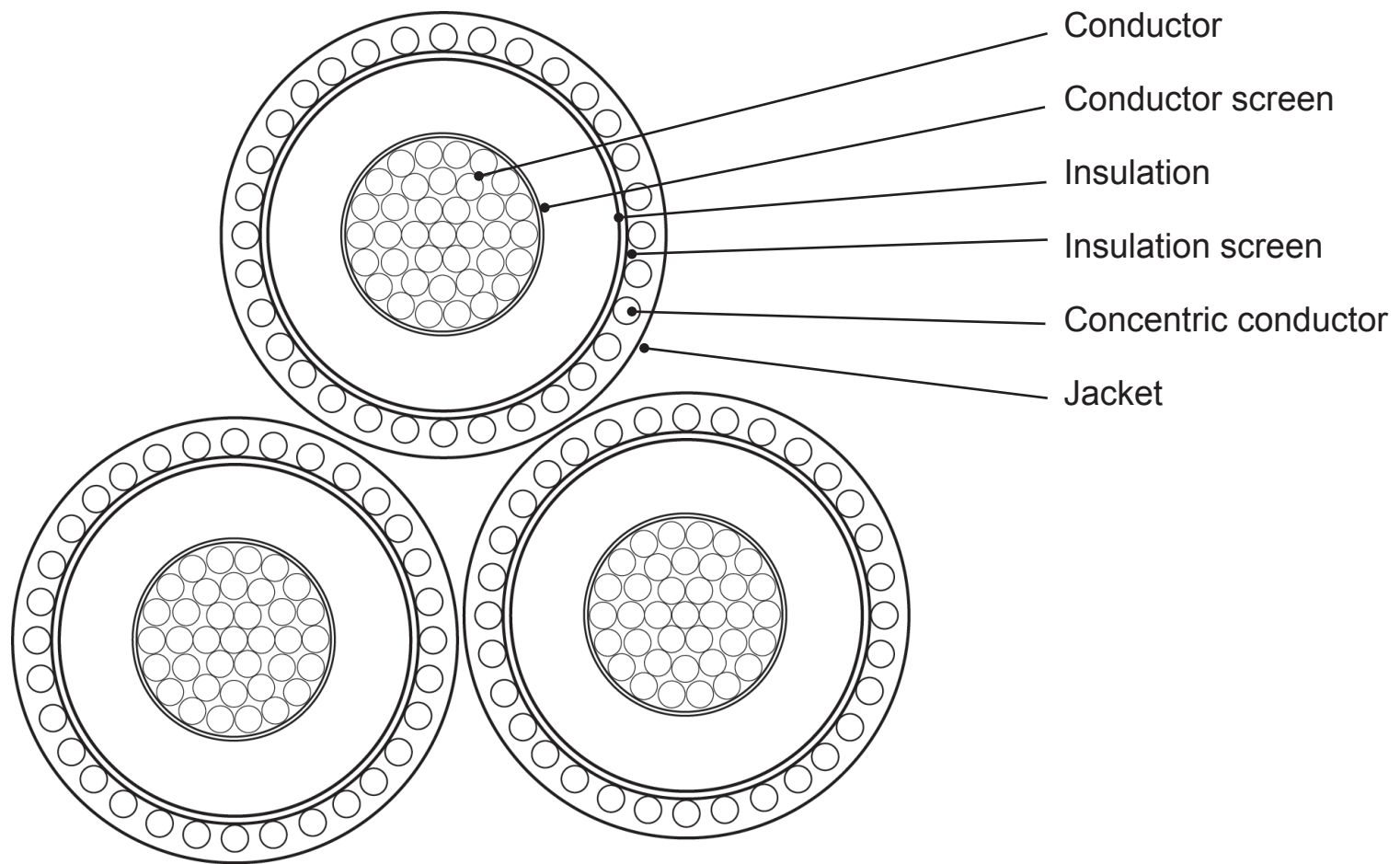

**TETRA TECH**

**Typical 34.5-kV Onshore Interconnection Cable**



**Dominion<sup>®</sup>**

Virginia Offshore Wind Technology Advancement Project  
Research Activities Plan

**Appendix D-1, Figure 4**