

Appendix M

**Report of the Effect on Radar Performance
of the Proposed Cape Wind Project
and
Advance Copy of USCG Findings and Mitigation**



Technology Service Corporation
an employee-owned company

55 Corporate Drive 3rd Floor, Trumbull, Connecticut 06611 ■ Phone: (203) 268-1249 ■ Fax: (203) 452-0260 ■ www.tsc.com

Ref: TSC-CT113-53

Report of the Effect on Radar Performance of the Proposed Cape Wind Project

**Submitted to the United States Coast Guard
December 16, 2008**

**USCG Order #HSCG24-08-F-16A248
Cape Wind Radar Study**

**David Rugger
Alan Pieramico
Terry Koontz**

1.0 Background

The proposed Cape Wind project is comprised of 130 General Electric 3.6MW wind turbine generators (WTG's) located near Horseshoe Shoal in Nantucket Sound. This proposed wind farm is bounded on three sides by channels that are routinely navigated by a range of vessel types, periodically in restricted visibility conditions. In this area, shipboard radar is frequently employed for collision avoidance and navigation.

There is a variety of vessels in the Nantucket Sound area. Commercial vessels include ferries, fishing boats and tug and barge combinations. The fishing vessels both fish the area and transit the area en-route to other destinations. The ferries include both traditional and high speed vessels. On occasion, other types of commercial vessels are present within the area. The area is also frequented by a large number of pleasure craft. These vessels are comprised of a wide variety of both type and size. Also, a large number of these pleasure craft are transiting the area, while some are based at the many harbors around the Sound.

The experience of the vessel operators within Nantucket Sound range from the very experienced professional mariner to the novice. On some vessels, a crew member is assigned to monitor the radar display, while on others only a single person is responsible for the safe navigation of the vessel, and can spare only an occasional glance at the radar display.

Radar equipment on the vessels range from no radar to very low end models to high performance equipment. It should be noted, however, that commercial marine radars in use in the Sound do not have Doppler capabilities.

2.0 Reason for Study

For the Cape Wind project, two documents have been submitted that attempt to assess the impact of the proposed wind turbines on typical marine radars used in the Nantucket Sound area. One of these documents was submitted by the Marico Marine Group^[1] as part of the required environmental evaluation by Cape Wind Associates, the developer of the proposed wind farm. The other was submitted by Dr. Eli Brookner^[2].

The two studies reached different conclusions with regard to the impact of the proposed turbines on the use of marine radars on navigation in the Nantucket Sound area. The document submitted by Marico concluded that the impact would be minimal, while the Brookner document concluded the impact would be severe.

Neither of the two documents fully evaluated the impact of the actual wind turbines proposed for the Cape Wind project. The Marico study based its conclusions mainly on results obtained from the wind farm located at Kentish Flats in the United Kingdom, and extrapolated these results to the Cape Wind project. The Brookner report took several evaluations from several different studies and extracted and annotated various plots and figures to show the potential impact of wind turbines on radar navigation.

Based on the above, the United States Coast Guard decided to commission this additional study conducted by Technology Service Corporation (TSC). TSC is a 40 year old company primarily engaged in providing engineering services and specialized hardware prototypes to U.S. Government agencies including the Department of Defense and the Federal Aviation Agency (FAA). TSC provides engineering support and technical assistance on the AN/SPY-1 shipboard radar for the Aegis cruiser and destroyer fleet. Most of TSC's other efforts are associated with the analysis, design, simulation, fabrication and testing of state-of-the-art sensors and signal processors. This work includes ground-based, ship-based, airborne and space borne radars. TSC was founded in 1966 by Dr. Peter Swerling, who developed the well known Swerling target fluctuation models. Other famous TSC radar engineers have included Dr. Fred Nathanson and Dr. Lamont Blake who developed extensive radar clutter and propagation models that are widely used in the radar engineering community today. Their work is included in some of the simulation software that was used in the analysis work conducted for this study.

TSC has operations in several locations within the Continental United States. The work performed in this report was performed by the Trumbull, CT Operations. The Connecticut Operations has performed advanced radar research and development for the Missile Defense Agency, Defense Advanced Research Projects Agency, Air Force and other customers since 1978. This work includes extensive ground-based radar siting and simulation modeling for the US Army, Marine Corps and FAA. Of particular note, the TSC Connecticut Operations developed the Radar Support System (RSS) for the FAA. The RSS is used extensively to site air traffic control radars and to evaluate the impact of new construction, including windmill farms, on radar performance.

Since this additional study was funded by the Coast Guard directly, the potential of bias due to any conflict of interest was eliminated. In addition, the Coast Guard directed the study to address its needs in evaluating the navigational impact of the proposed wind turbines. Finally, this additional study was designed to evaluate the proposed Cape Wind project directly, rather than extrapolate from studies conducted at other locations or from general studies of wind turbine impact on radar performance.

In summary, the purpose of this new additional study was to evaluate these two previous studies, and employ the best analysis tools and expertise to sort out the most likely impacts prior to allowing construction of the wind farm.

3.0 Scope of Study

This study is designed to provide a simulation of the radar performance in the vicinity of the 130 WTGs of the proposed wind farm. The radars of interest are commercial off-the-shelf marine radars that vary in size and operating characteristics. For the study the impact of the Cape Wind project on several typical marine radars was evaluated. These marine radars were a low end radar with a 15 inch antenna, a high end radar with a 4 foot antenna, both operating at X-band, and a high end radar with a 12 foot antenna operating

at S-band. These radars would encompass almost all of the characteristics of radars operating in Nantucket Sound on both commercial and pleasure craft.

The evaluations performed in this study are limited to radar performance. No attempt was made by TSC to evaluate the actual impact due to the wind turbines on navigation. Instead, TSC provided the Coast Guard with the simulated radar performance and an explanation of those simulations. Although TSC has a long and extensive history in radar evaluation, TSC has no expertise in maritime rules and navigation procedures.

Both this final report, and the analysis it is based on are designed to address only the needs of the United States Coast Guard and to provide the Coast Guard with information so that an informed recommendation by the Coast Guard can be made regarding the navigational hazards posed by the proposed wind farm in Nantucket Sound.

4.0 Details of Study

Two major issues are of concern with regard to radar performance in the vicinity of the wind turbines. These are the effect of radar antenna beamwidth and sidelobes on the detectability of vessels and the effect of false targets caused by secondary reflections off the wind turbines. Both these concerns were stated during the workshop on radar navigation of October 7, 2008 conducted by the Coast Guard^[3]. The analysis whose results are presented in this report concentrated on evaluating these two effects. Several effects that commonly occur with, for example, air traffic control radars, are not applicable to the commercial marine radars evaluated in this study.

The power transmitted from a radar antenna is spread in both elevation (vertically) and azimuth (horizontally) to form a beam that has both an azimuth and elevation extent. As the radar antenna is swept (rotated) in azimuth, power over this entire azimuth beamwidth is transmitted, reflected from an object and received by the radar. The signal displayed is thereby spread in azimuth on the radar display. In addition, antennas have additional peaks offset in angle from the main beam. These peaks have a much lower gain than the main beam, but are often sufficiently great to cause the object to be displayed on the radar screen. The location of the object in this case would be offset in azimuth from its actual position. These peaks are referred to as sidelobes, and their effect shown in the display of the object on the radar screen is also commonly referred to as sidelobes^[4]5.

The most basic antenna will have relatively high sidelobes. However, this was not the case for the antennas used in any of the marine radars examined. Manufacturers have developed antennas with low sidelobes over the many decades that marine radars have been available. Even the very low end radars examined had antennas with low sidelobes. The Coast Guard obtained several proprietary antenna patterns from marine radar manufacturers and made them available to TSC. These actual patterns were used in the radar simulations performed for this study. Also, an examination of the published specifications for competing products from other manufacturers indicated that these antenna patterns were typical of commercially available marine radars. By agreement with the manufacturers, these patterns cannot be further disseminated.

The azimuth beamwidth of a radar antenna is dependent on the width of the antenna. A wider antenna gives a narrower beam, for a given operating frequency. Generally, for the antennas modeled, at X-band, a 15 inch antenna will produce a beamwidth of approximately 4 degrees while a 4 foot antenna will produce a beamwidth of about 1.8 degrees. A 12 foot antenna at S-band produces a beamwidth of about 1.8 degrees. Generally, at a given frequency, the more expensive a radar, the wider the antenna and the narrower the beam. The beamwidths specified here are between the points where the antenna gain is $\frac{1}{2}$ the gain at the center peak of the antenna (one-way 3dB points). Antenna beamwidths are approximately 20% to 25% wider when measured between the points on the antenna where gain first falls to almost 0.

Manufacturers generally produce all marine radars with elevation beamwidths of approximately 20 degrees to allow the main beam to illuminate a target even if the vessel the radar is mounted on experiences a significant amount of roll. For vessels that normally experience extreme roll, gimballed mounts are generally provided to allow the radar to remain in a horizontal plane.

A radar signal can be reflected from a wind turbine toward a second turbine, and then reflected back by this second turbine to the first turbine and then back to the radar. Normally, the signal reflected this number of times is too weak to be displayed on the radar screen. Frequently, however, these signals do have sufficient power to cause a false target to appear on the screen. These false target signals appear directly behind the first turbine at a distance equal to the separation between the two turbines. The strength of the signal is dependent on the orientations and ranges to and between the two turbines. These false target signals can also be caused by reflections between a vessel and a turbine or between two vessels.

Commercial marine radars employ no Doppler (velocity) processing. This means that a moving target is processed in exactly the same way as a stationary one. For radars that employ Doppler processing, the moving blades of a wind turbine can have a significant detrimental effect on detecting other moving targets. This is not the case with marine radars, however, since no attempt to distinguish moving from stationary objects is made with these radars.

Even though an over-water environment produces significant refractive changes in the atmosphere, the effect of atmospheric ducting on the wind turbines is not a factor at the short ranges employed by the radars within Nantucket Sound. For this reason, no anomalous propagation effects were considered in this analysis.

Although there can be some fading of the radar signal behind a wind turbine tower^[6], this effect is limited. TSC simulation and theory^[7] indicate that the effect is approximately 15-20dB, but over a very small angular extent. Target radar cross section (RCS) changes can easily exceed this as the aspect angle of the vessel with respect to the radar changes by only a very few degrees or so. The effect is also very transitory. TSC did not include these effects in its analysis.

5.0 Modeling

The Coast Guard provided TSC with four general scenarios of vessels moving in the vicinity of the proposed wind farm within Nantucket sound. TSC then conducted a detailed radar simulation based on these scenarios of vessels and turbines within Nantucket Sound.

The model of WTG proposed by Cape Wind is the GE 3.6MW. TSC obtained a CAD model of this WTG, modified it to reflect the proposed tower dimensions, and then processed the model to make it suitable for determining the radar cross section (RCS) of the turbine^[8]. The RCS was determined at all elevation and azimuth angles with an angle spacing of ½ degree. The blade rotational position that gave the greatest RCS was used for each grid point. This provided a worst case reflectivity situation in the analysis. RCS was determined for both X and S band.

In addition, the reflectivity of the turbine in directions other than directly back toward the radar was determined over the same angular spacing. Angular reflections were provided at ½ degree orientations. These values were used to determine the false target signals due to the secondary reflections from other turbines as mentioned above.

TSC also obtained CAD models of vessels similar to those typically present in Nantucket Sound. From these models, reflectivity tables in the same format as those of the turbines were determined for these vessels. Five vessels were modeled: a high speed and traditional ferry, an oil barge with tug, a small commercial fishing vessel, and a Boston Whaler sized vessel. All vessels except the Whaler were modeled as having metal construction. The Whaler was modeled as having fiberglass construction. These vessels are shown in Figure 1 through Figure 5. Dimensions and nominal radar cross sections (RCS) of the vessels are given in Table 1. Peak RCS normally occurs broadside to the vessel.

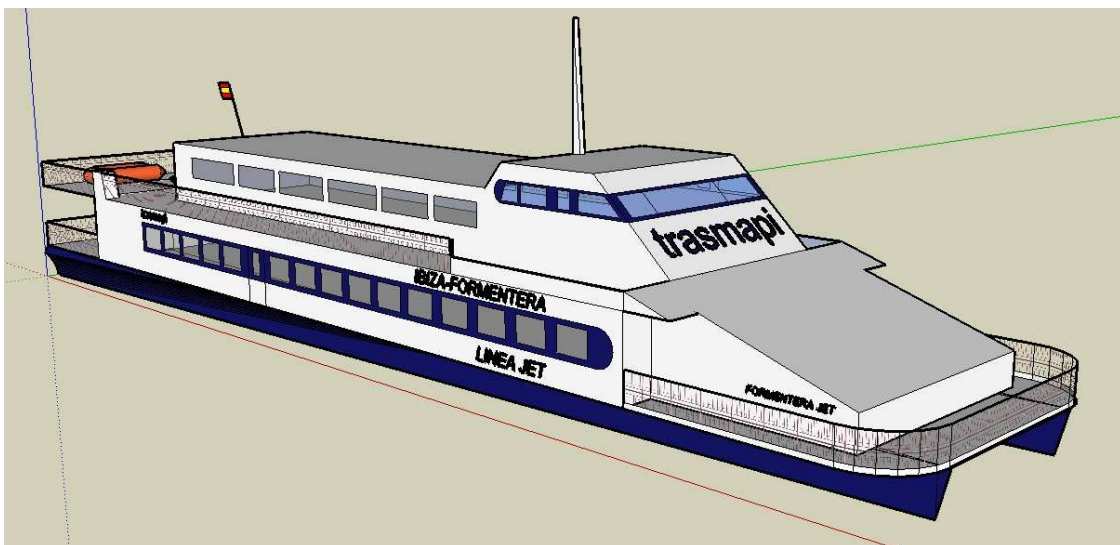

Figure 1: Model of High Speed Ferry

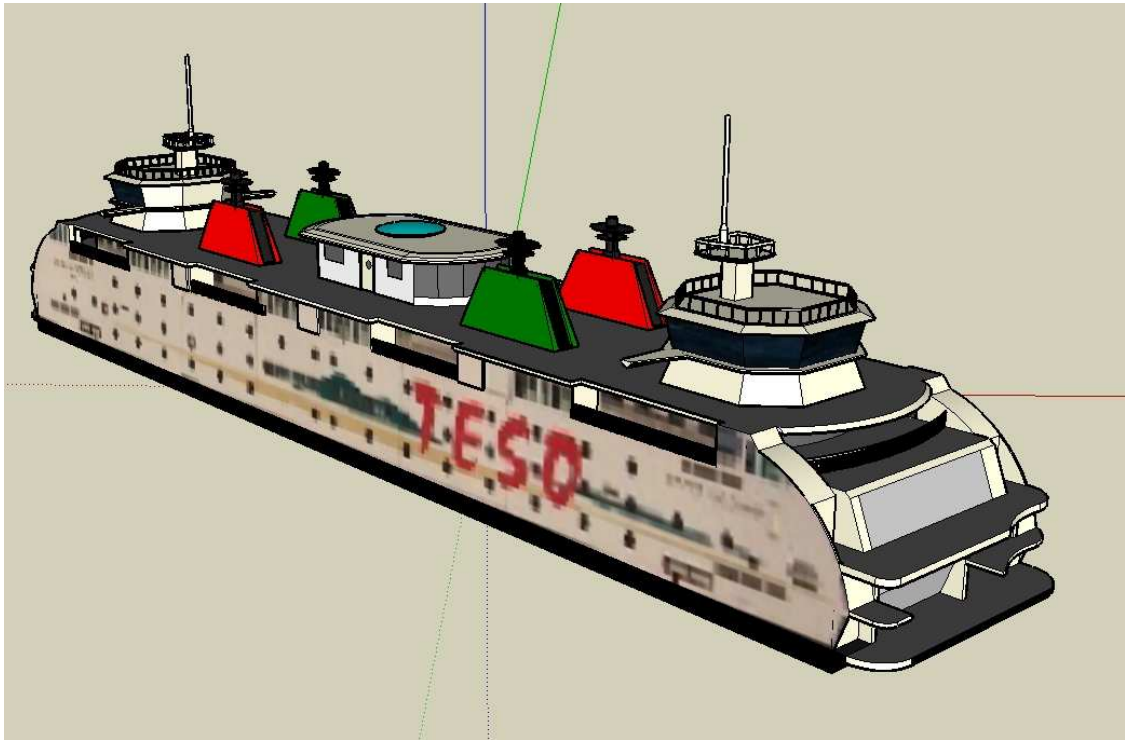

Figure 2: Model of Traditional Ferry

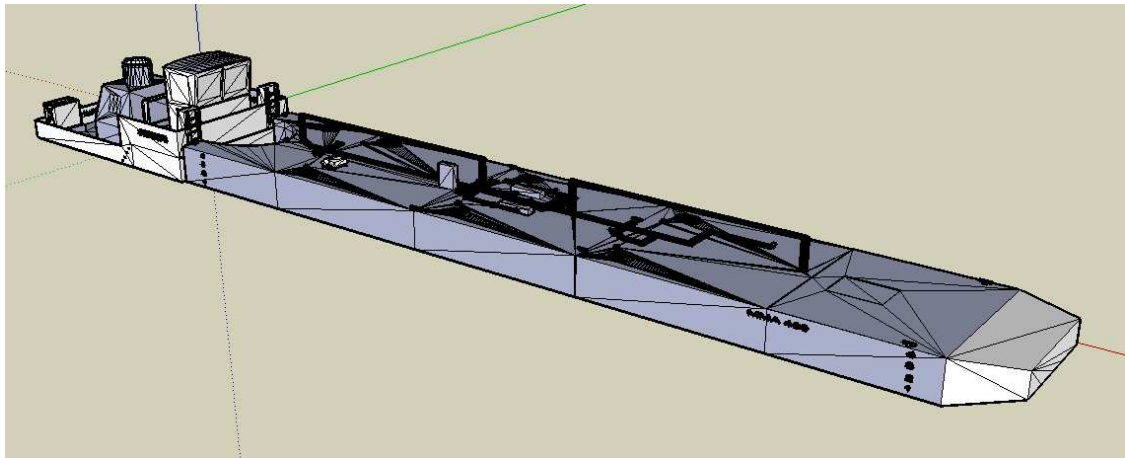

Figure 3: Model of Tug and Oil Barge Combination

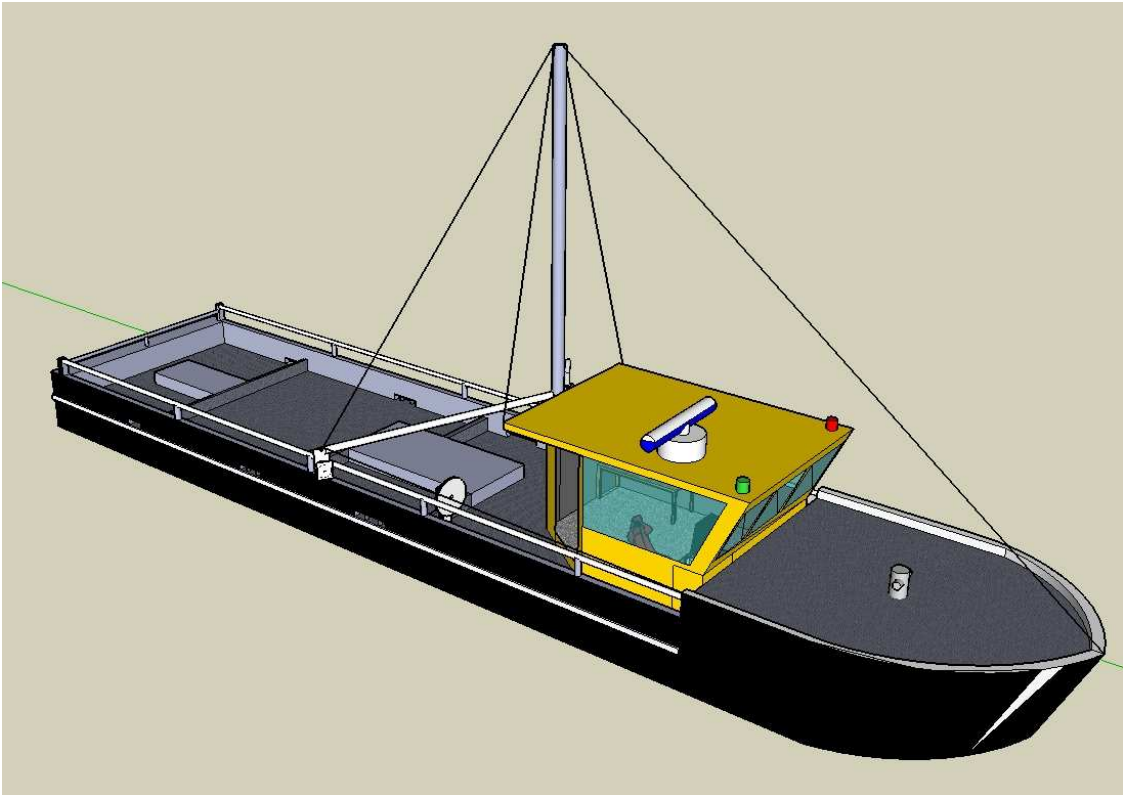

Figure 4: Model of Commercial Fishing Boat

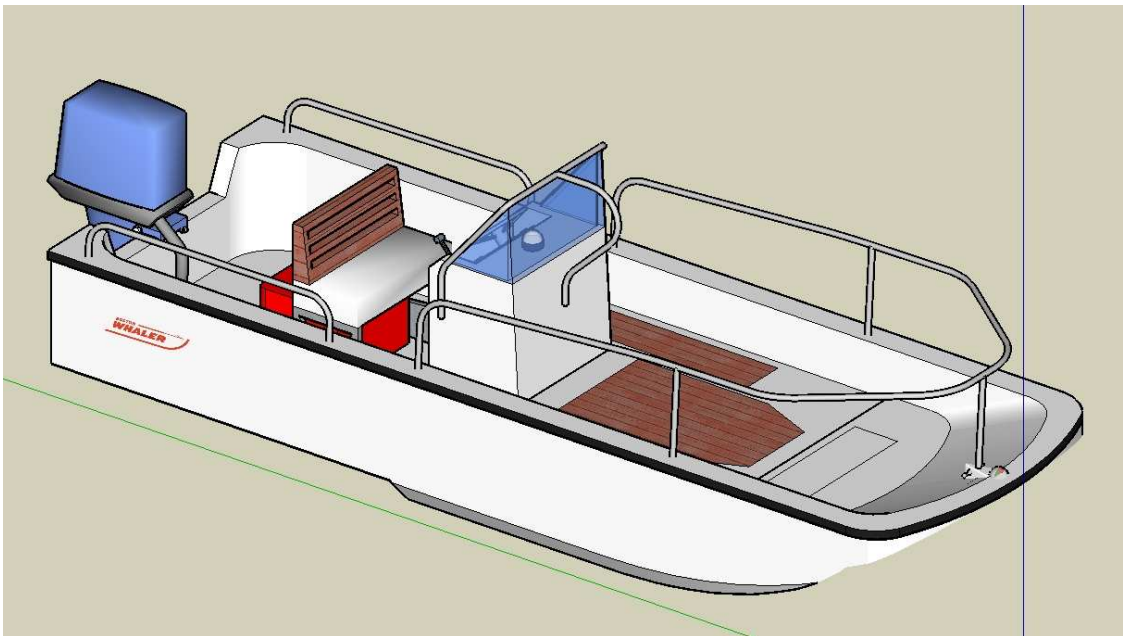

Figure 5: Model of Boston Whaler

Table 1: Dimensions and RCS of Vessels Used in Scenarios

Vessel	Length (m)	Height (m)	Peak RCS (dBsm)	Nominal RCS (dBsm)
Boston Whaler	7.2	2.4	46	3
Traditional Ferry	71.6	16.8	61	25
Fishing Boat	10.7	4.7	53	22
High Speed Ferry	43.7	11.6	84	15
Oil Barge with Tug	116.8	11.2	66	35

The parameters of several radars were obtained along with the corresponding antenna patterns. TSC then modeled these radars in the Radar Support System (RSS)^[9] radar simulation software developed by TSC for the Federal Aviation Administration and modified for this project.

Vessel tracks were determined for the four scenarios requested by the Coast Guard. For each scenario, a meeting situation between the vessels was created, and a radar model assigned to each vessel. The Whaler was assumed to have no radar. Along each vessel path, a simulated radar display was created for each individual position of the vessels. The positions were separated by the distance the vessel would travel at its indicated speed during the time the radar made one complete sweep. The other vessels within the scenario were also repositioned in a similar manner. These individual radar displays were then assembled into a video format.

Although the sweep rate for most radars was approximately 2.5 to 2.6 seconds, the video frame rate was kept constant at 0.5 seconds across all scenarios. This was to allow for a shorter and therefore more reasonable time to view the videos an entire scenario. Each video consisted of between approximately 300 and 800 frames. Radar provides a dynamic depiction of a constantly changing environment. It is the changes that are visible on a radar screen that provide the information that is most valuable to the operator. The still pictures presented in this report are a small representative sample of these frames but because they are stills they do not depict the changes a working radar or the video are capable of displaying. The entire videos have been presented by TSC to the Coast Guard and form the basic information for Coast Guard understanding of the effects of the proposed wind farm on marine navigation.

The video data is extremely large; many tens of gigabytes. The format of the videos is easily shown on a computer, but is not amenable to conversion to normal DVD format.

For each simulated radar scan, the reflectivity of the visible land, the water, any precipitation, each of the 130 turbines and up to two other vessels was determined. The reflectivity for each of these objects was determined by the RCS in the model described above. The orientation of the object with respect to the radar provided the angles needed to determine the appropriate RCS to use. The wind turbines were always oriented to face the specified wind direction, while each vessel was oriented along its track. Each possible pairing of all turbines and vessels was also considered in order to provide for

potential false target signals. The radar signal produced by these objects was then calculated.

6.0 Pictures and Discussion

The first scenario considered is shown in Figure 6. Scenario 1 consists of a combined oil barge and tug traveling eastbound at 12 knots in the main channel that is located south of the proposed wind farm. A ferry is southbound at 14 knots along its normal route east of the wind farm. In addition, a Boston Whaler sized boat is traveling at 30 knots within the wind farm and exits to the south into the path of the oil barge/tug. Both the tug and the ferry have X-band 4 foot radars set to a 6 nmi range. The wind is from the southwest, there is no precipitation, and seas are calm. In this and all scenarios, sensitivity time control (STC) was turned on.

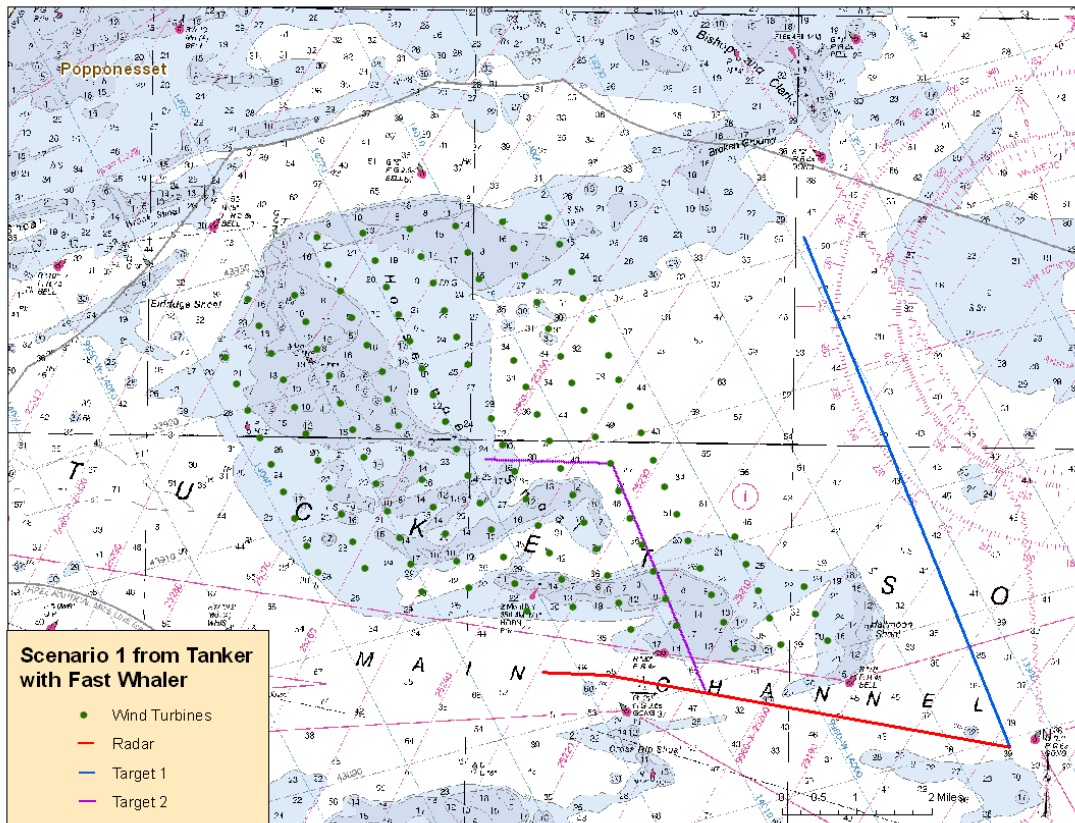

Figure 6: Vessel Tracks for Scenario 1

One radar sweep from the barge/tug is shown in Figure 7. The barge/tug is the blue dot located in the center of the picture. Several of the phenomena discussed above are visible in this frame. Also notice that for increasing distance from the radar, the width of the signal reflected from a turbine is greater than for those turbines located close to the radar. The angular extent remains the same, but the cross range for the same angle increases with range. This means that the beamwidth/sidelobe extent of a turbine close to the radar will occupy a smaller area compared with a more distant turbine. Also, the broadening

due to beam width or sidelobes is always oriented perpendicular to the radar. Vessels traveling directly toward the radar will always travel across these sidelobes, never along them. This means that there will be at least some time when a vessel traveling toward the radar is in a clear area between the turbine sidelobes.

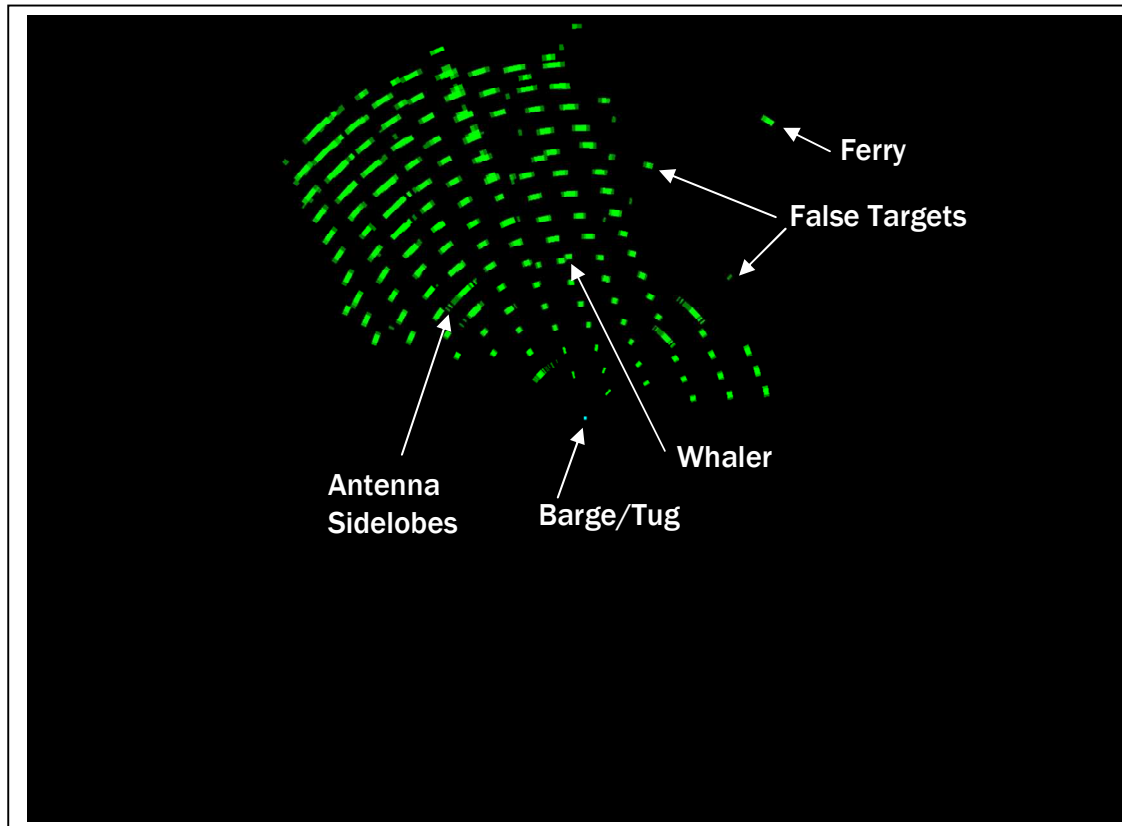

Figure 7: Sample 6 NMI Radar Sweep from Oil Barge/Tug

It can be seen in the frame that for turbines that are oriented to the northwest and northeast of the radar, a significantly stronger return occurs. This is due to the orientation angle of the turbine nacelle with respect to the radar. The nacelle is the strongest reflecting surface at certain orientation angles, such as when the front, back or sides are oriented perpendicular to the radar. The GE3.6 turbine nacelle has a large number of large angular surfaces that are superb radar reflectors. These surfaces are shown in Figure 8. TSC did not examine whether a different model of turbine would have significantly lower radar reflectivity.

Although it cannot be shown in a still image, the sidelobes and false targets constantly change over several frames or even from frame to frame. As the radar moves, the orientation of individual turbines changes with respect to the radar. This changes the reflectivity, which changes the extent of the beamwidth/sidelobe spreading and also changes the reflectivity to secondary (false) reflections.

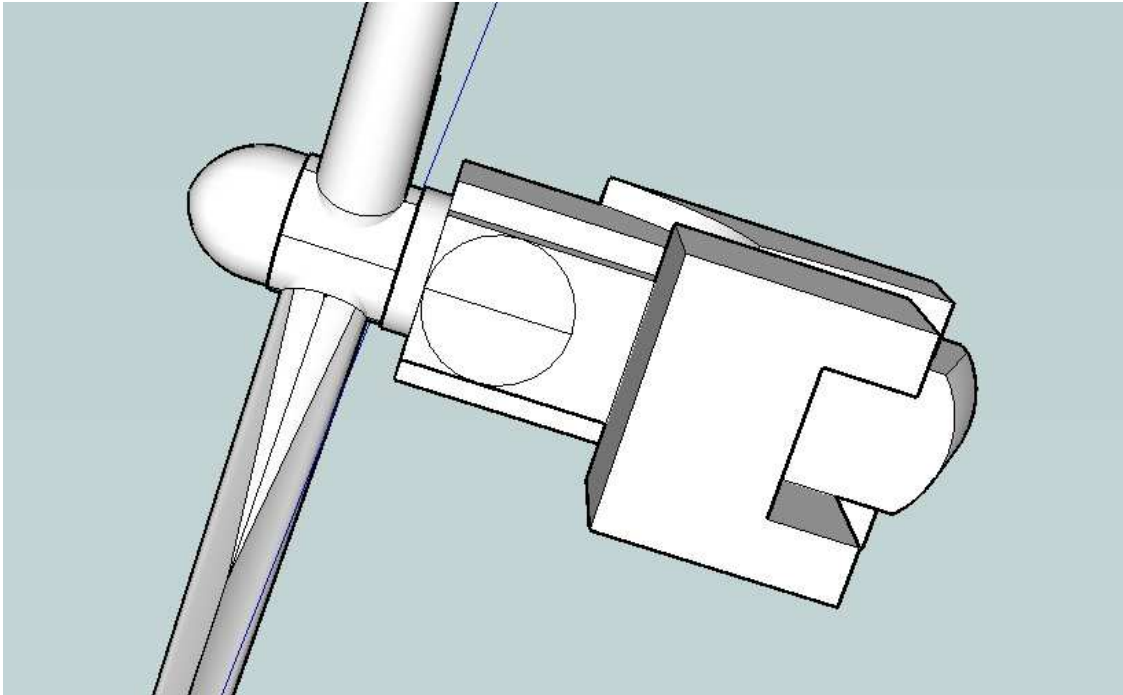

Figure 8: Underview of GE3.6 Wind Turbine Nacelle

One of the Coast Guard's questions is whether the whaler can be observed as it travels within and then exits the wind farm. Figure 9 shows the simulated display after the whaler has turned southward. At this point the whaler is visible on the display. Several sweeps later, however, in Figure 10, the display of the whaler has been subsumed into that of the nearby turbine, and is not visible. This lasts only a couple of scans until the whaler separates from the display of the turbine and again becomes visible in Figure 11. This pattern repeats as the whaler passes each turbine. If the whaler passes sufficiently close to the southernmost turbine, it will be subsumed in the display, also, as shown in Figure 12. Finally, the whaler exits the wind farm and separates from the turbine, as shown in Figure 13. The time before the meeting in the scenario is given in the captions in minutes and seconds, and is the real time, not the time as sped up in the video.

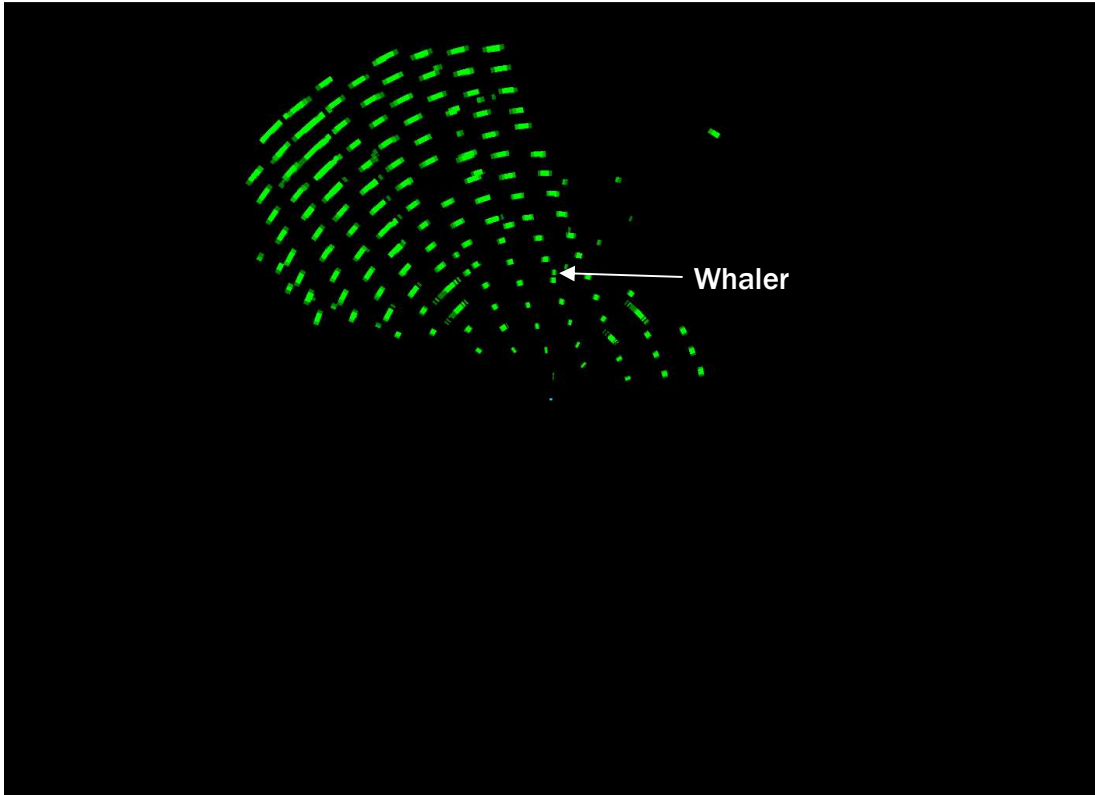

Figure 9: Six NMI Scan of Barge/Tug Radar 3:50 Before Meeting with Whaler

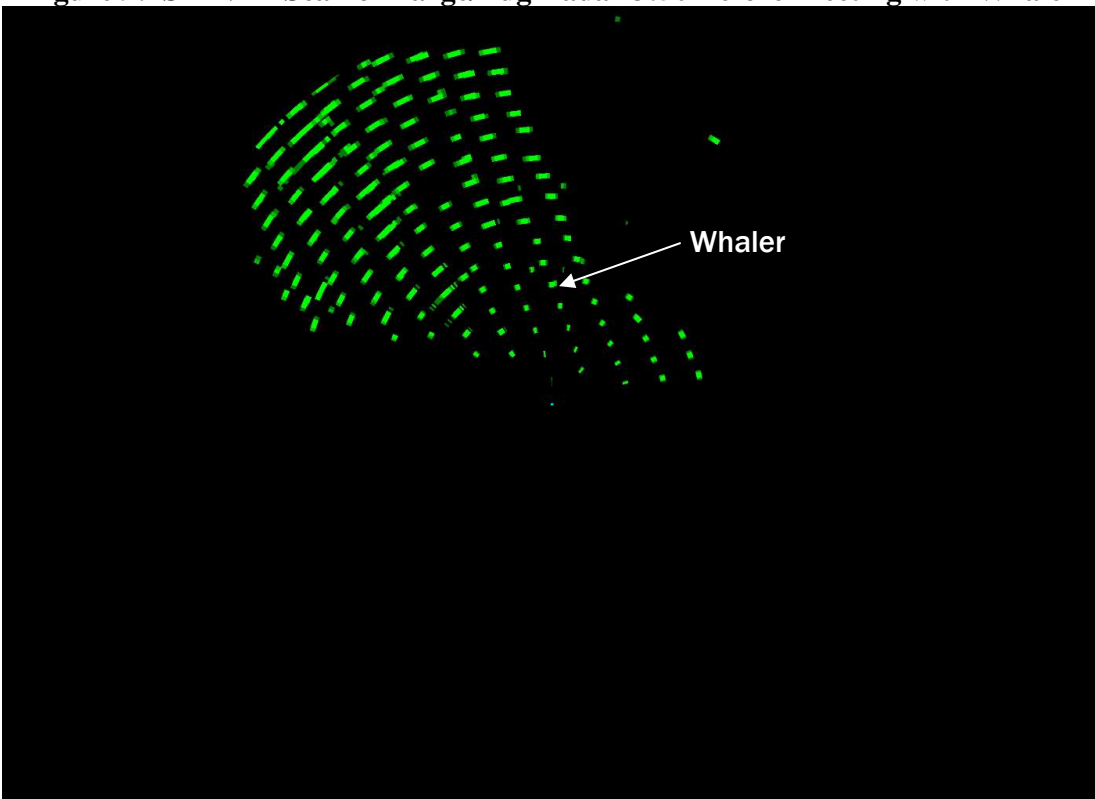

Figure 10: Six NMI Scan of Barge/Tug Radar 3:33 Before Meeting with Whaler

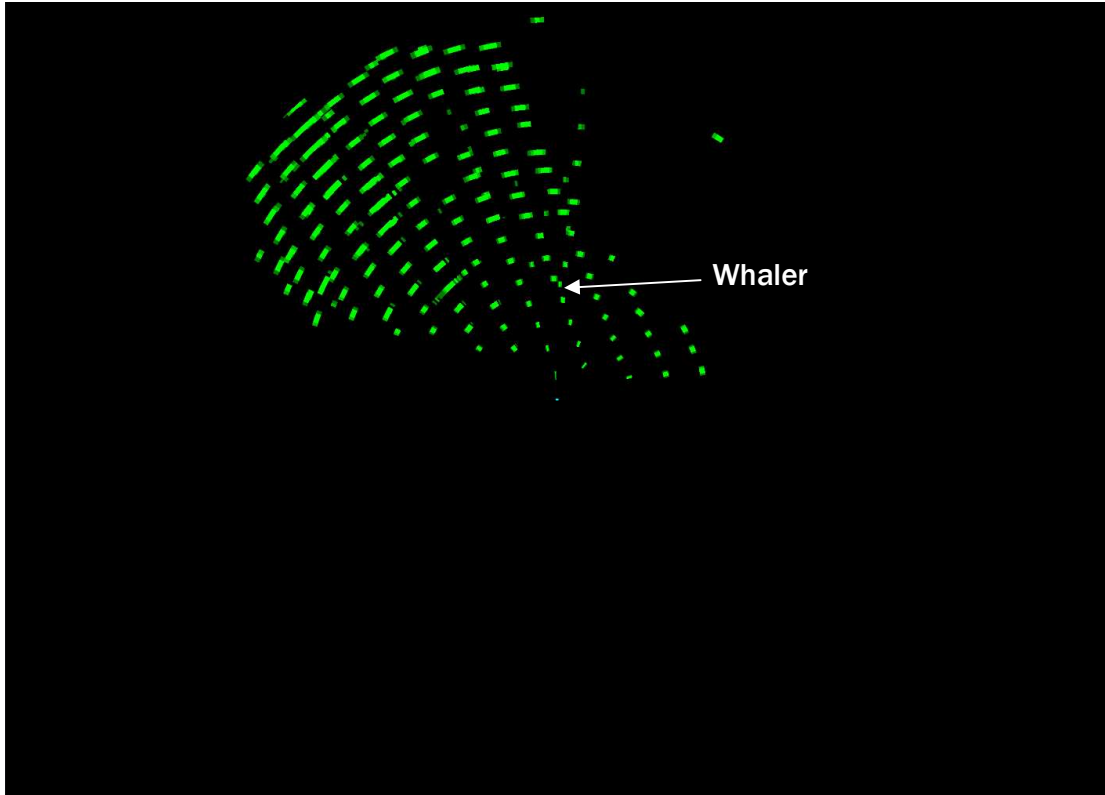

Figure 11: Six NMI Scan of Barge/Tug Radar 3:23 Before Meeting with Whaler

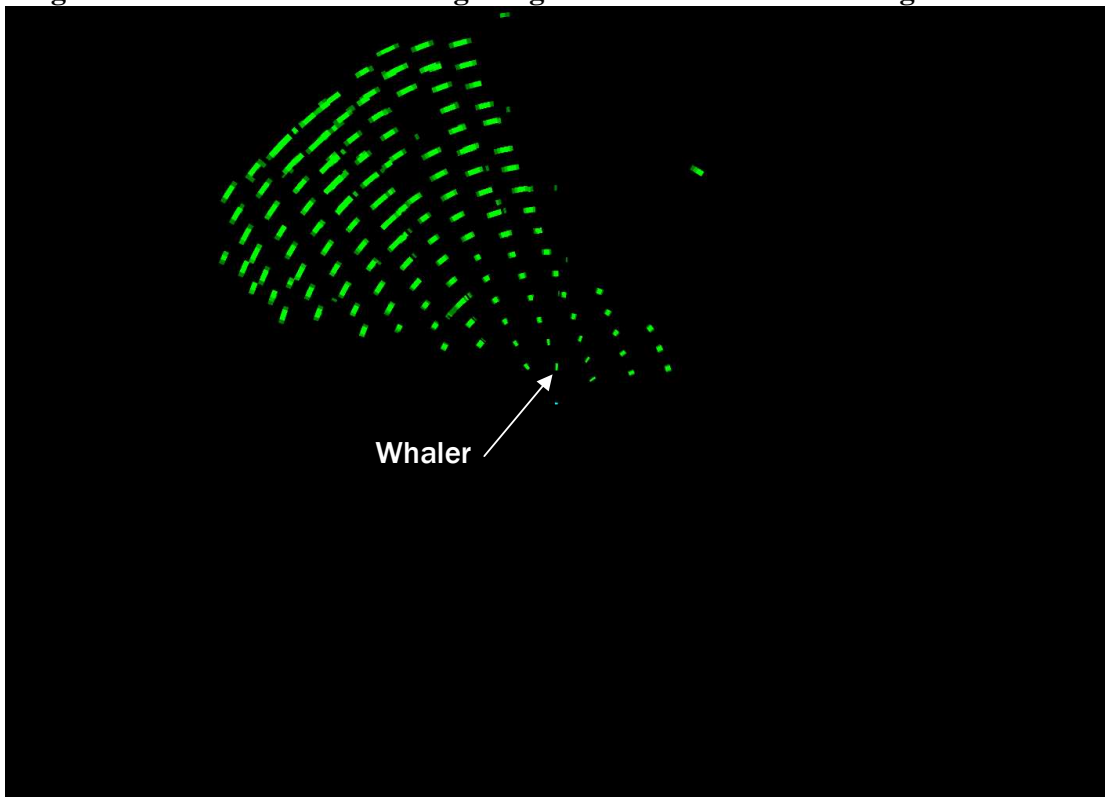

Figure 12: Six NMI Scan of Barge/Tug Radar 0:52 Before Meeting with Whaler

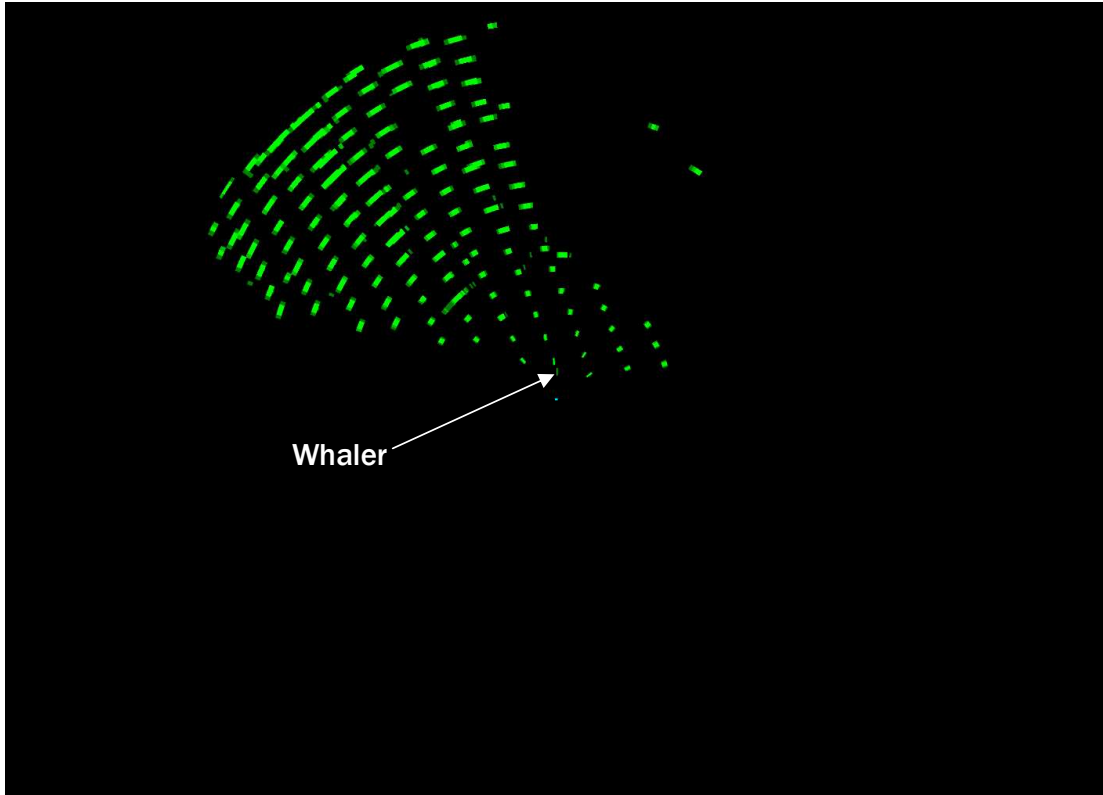

Figure 13: Six NMI Scan of Barge/Tug Radar 0:37 Before Meeting with Whaler

This scenario was also run with a vessel with a 12 foot S-band radar on the same track as the oil barge/tug. An example of this type of vessel may be a cruise ship traversing the area. A sample scan is shown in Figure 14. Results are very similar to that obtained with a 4 foot X-band radar.

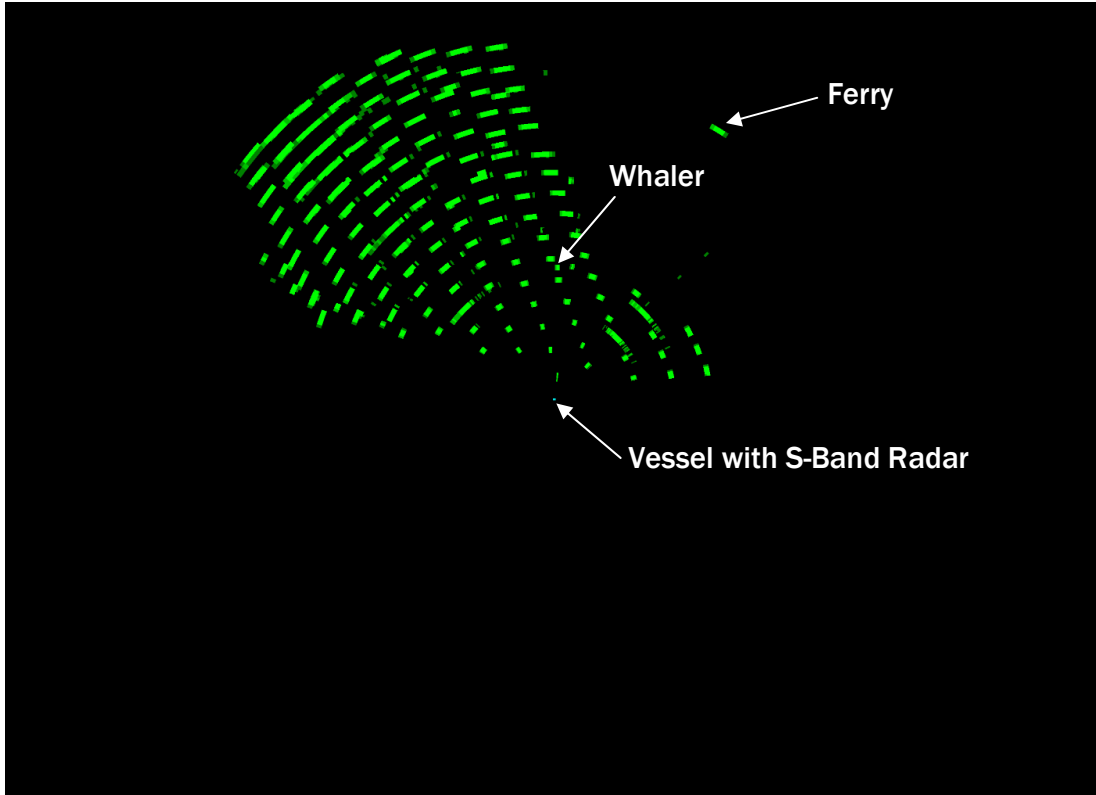

Figure 14: Six NMI Scan of S-Band Radar 3:50 before Meeting with Whaler

In Scenario 2, shown in Figure 15, a commercial fishing boat is exiting the wind farm at the northwest corner, while a westbound high speed ferry turns around the same corner. The fishing vessel is traveling at 5 knots, while the fast ferry is traveling at 30 knots. The fishing vessel has a low end 15 inch radar, while the high speed ferry has a 4 foot radar, both operating at X-band and set to a 6 nmi range. Again, the wind is from the southwest, there is no precipitation, and seas are calm.

In Figure 16, one radar sweep is shown from the fishing boat. The radar is located at the center of the image. Notice that the turbines are spread much more broadly here compared with that shown in Figure 7. This is due to the broader beamwidth of the low end 15 inch radar displayed. However, the ferry is still clearly visible just north of the wind farm.

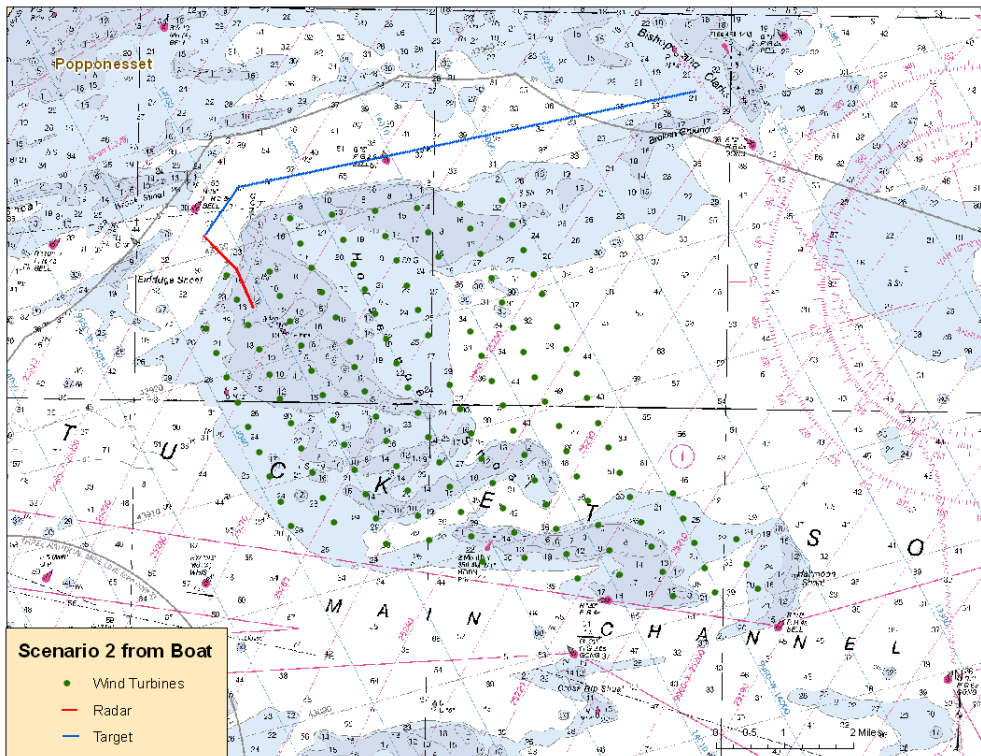

Figure 15: Vessel Tracks for Scenario 2

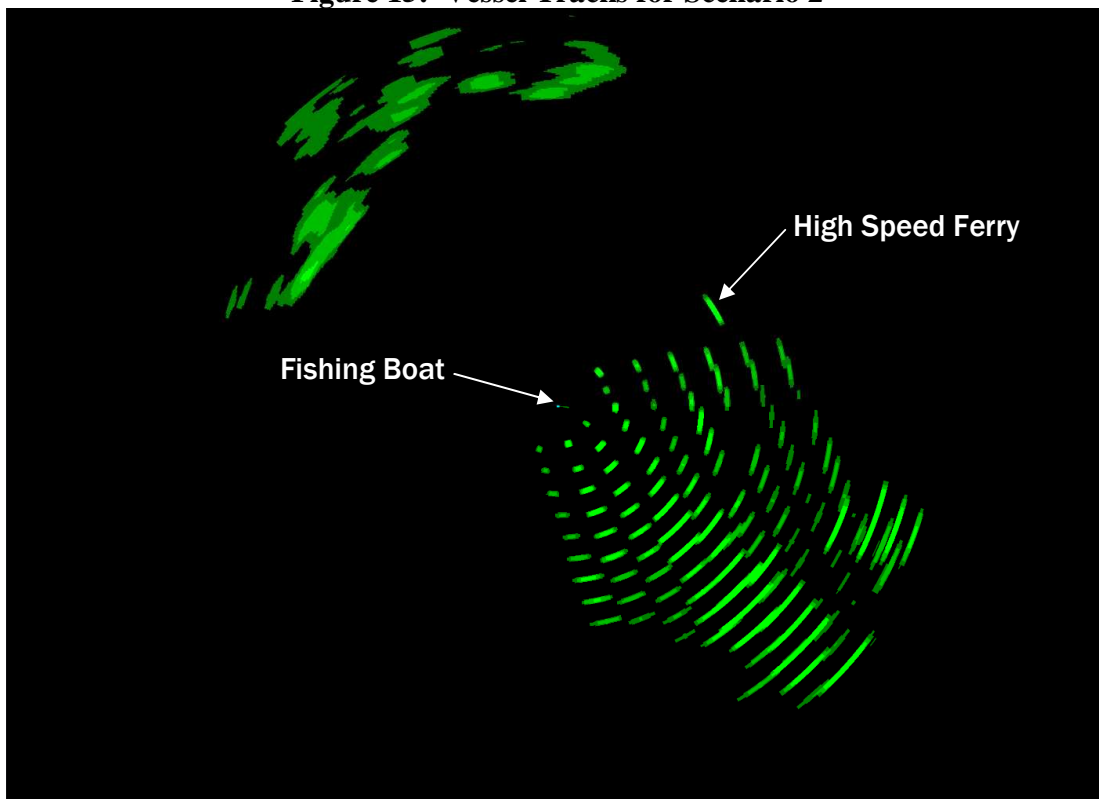

Figure 16: Sample 6 NMI Radar Sweep from Fishing Boat

A view from the ferry is shown in Figure 17. The reflection from the fishing boat remains on the display while the false targets occur for only a few scans. Another view from the ferry is shown in Figure 18. This is just as the ferry turns the corner at the northwest of the wind farm.

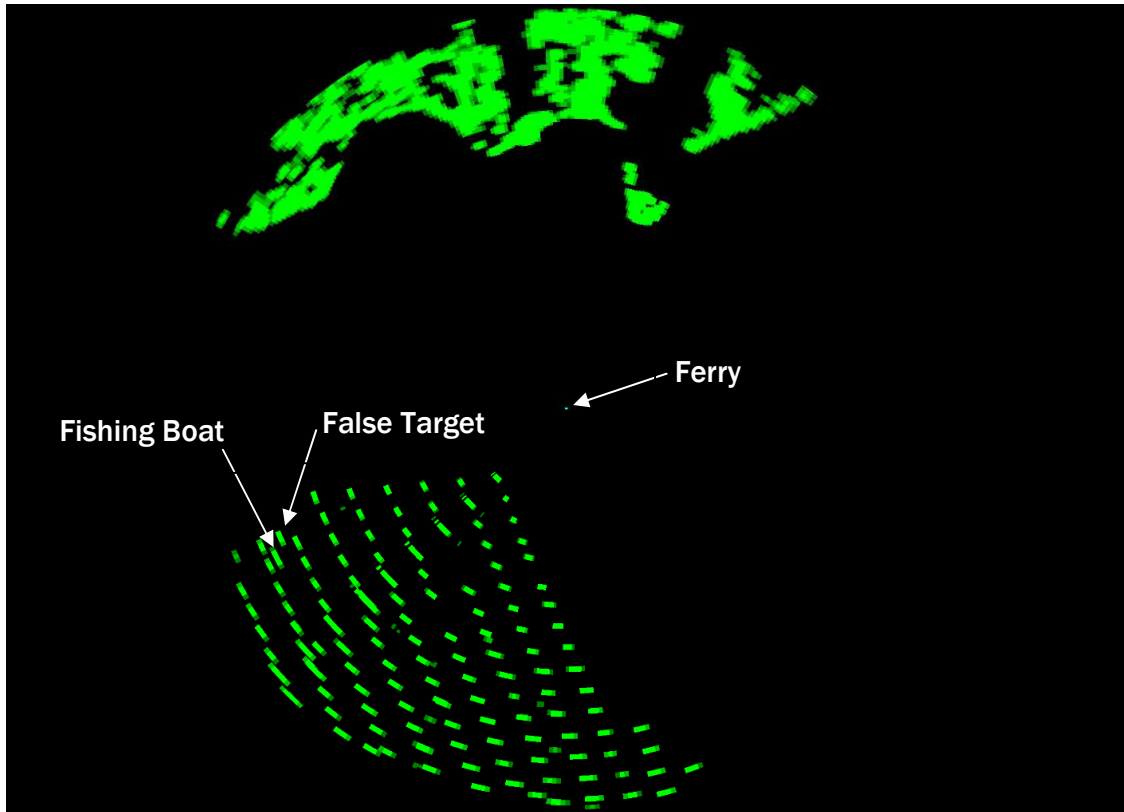

Figure 17: Sample 6 NMI Radar Sweep from High Speed Ferry

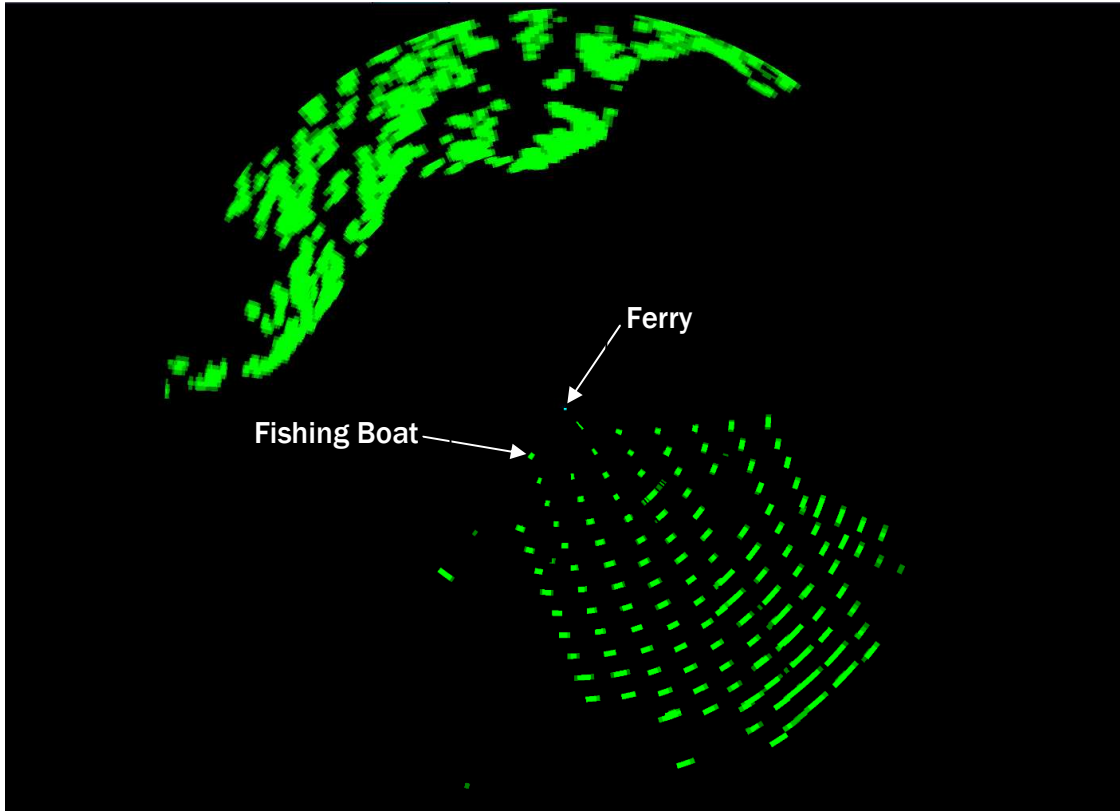

Figure 18: Sample 6 NMI Radar Sweep from High Speed Ferry at Northwest Corner of Wind Farm

Scenario 3 is shown in Figure 19. Two fishing vessels are within the wind farm on a head-on meeting course. The southbound vessel is traveling at 5 knots and the northbound vessel at 3 knots. In addition, there is an anchored Boston Whaler sized vessel located at approximately the meeting point of the two vessels. Both fishing vessels have low end X-band radars with 15 inch antennas. The radars are set to a 1.5nmi range. The wind is from the southwest, there is no precipitation, and seas are calm.

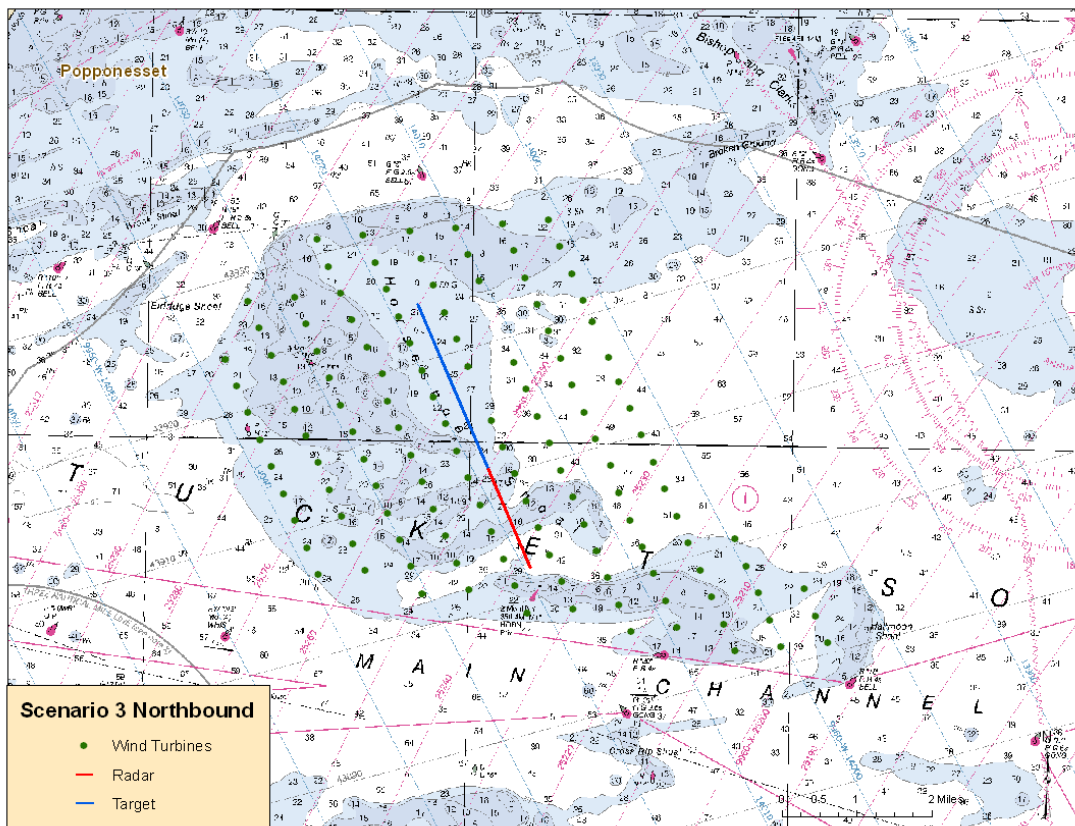

Figure 19: Vessel Tracks for Scenario 3

Figure 20 shows the view from the northbound vessel. For this sweep, the southbound vessel may not be able to be distinguished from the adjacent wind turbine. However, this is a temporary condition. The vessel quickly separates from the turbine, as shown in Figure 21. The whaler remains visible in both displays.

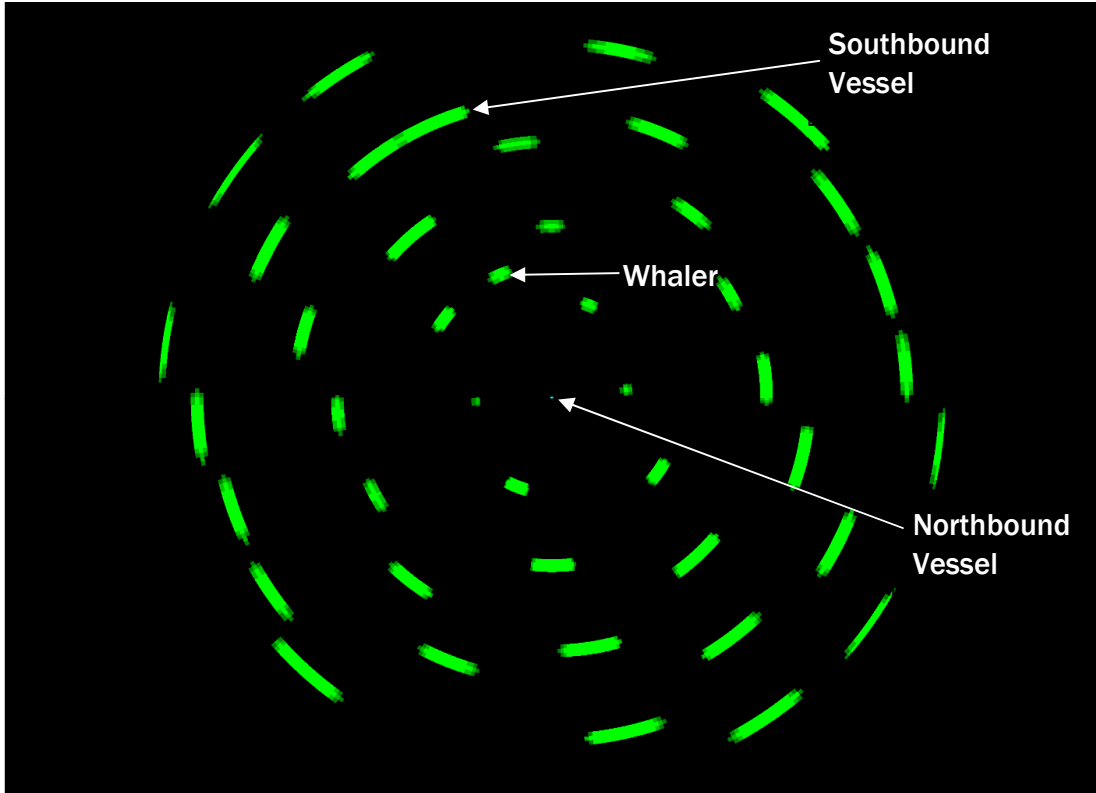

Figure 20: 1.5 NMI Scan of Fishing Boat Radar 8:42 Before Meeting

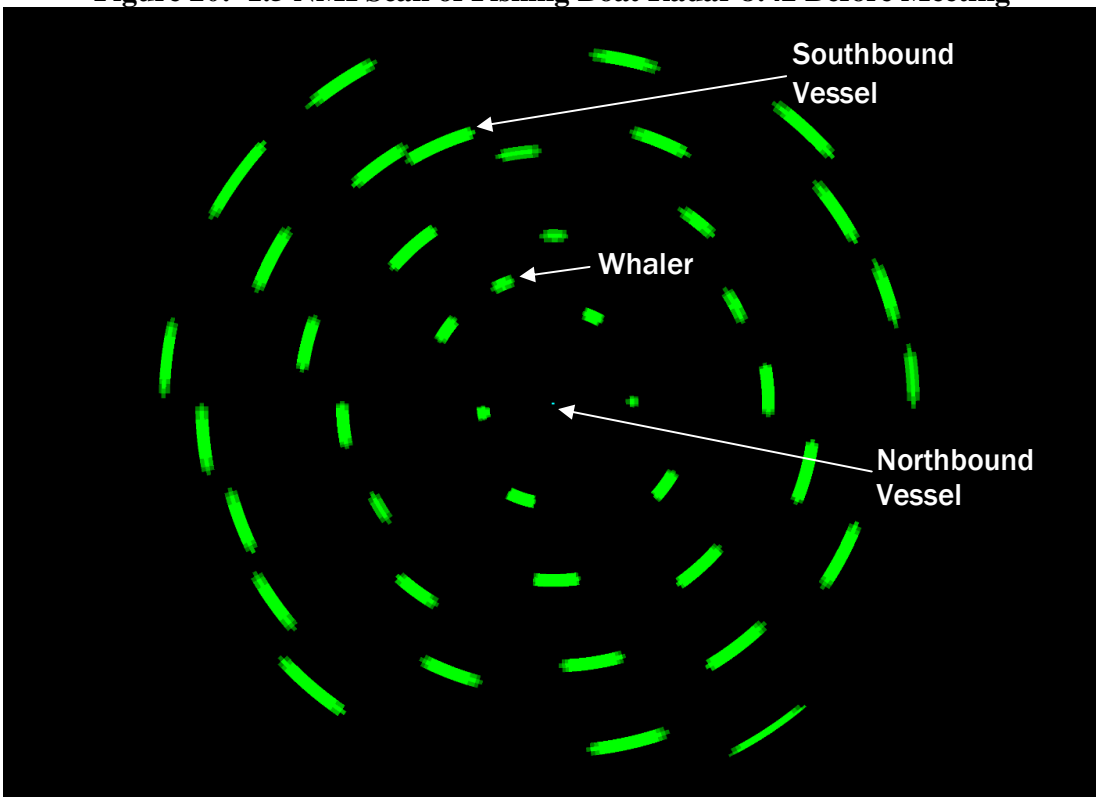

Figure 21: 1.5 NMI Scan of Fishing Boat Radar 8:04 Before Meeting

Scenario 4 is shown in Figure 22. A fishing boat is traveling at 10 knots eastbound in the north channel while a ferry is northbound at 14 knots on its regular route east of the wind farm. A Boston Whaler sized vessel is traveling at 30 knots within the wind farm and exits to the north into the path of the fishing vessel. The fishing vessel has a low end 15 inch radar, while the ferry has a 4 foot radar, both operating at X-band and set to a 6 nm range. Again, the wind is from the southwest, there is no precipitation, and seas are calm.

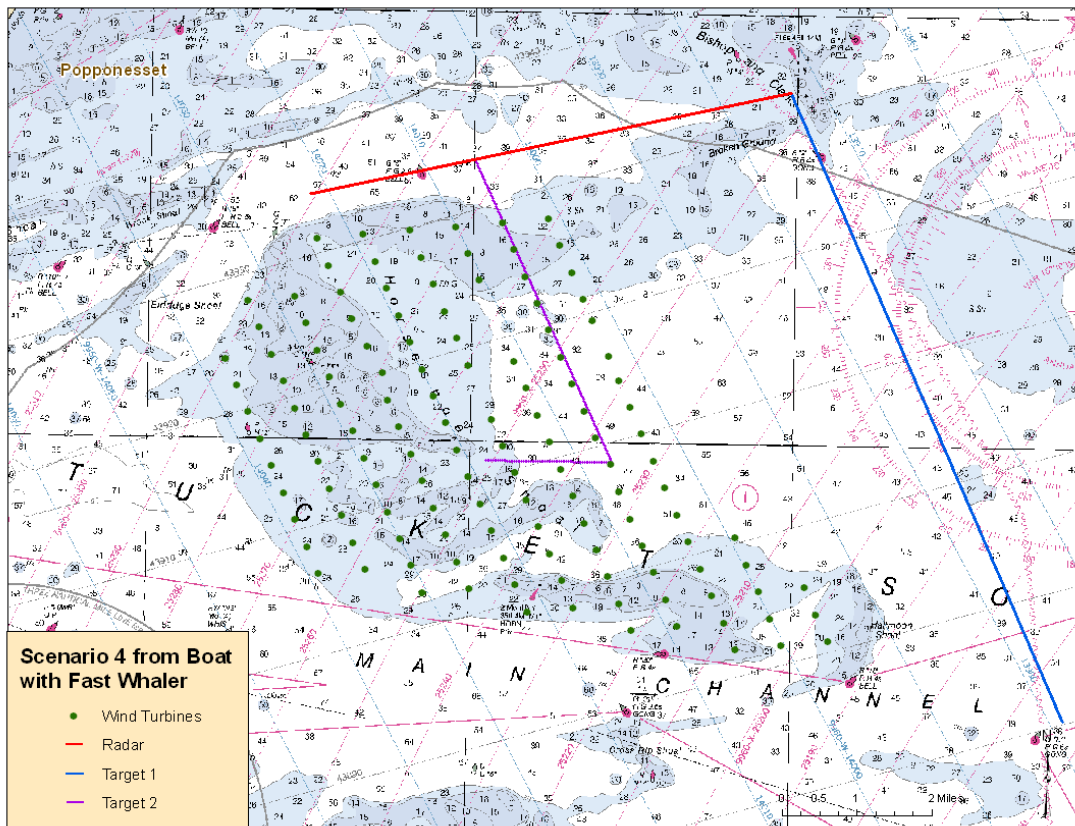

Figure 22: Vessel Tracks for Scenario 3

Figure 23 shows a scan of the view from the fishing boat. The ferry has not yet come into radar range. The whaler can be seen in the scan between the wind turbines. Periodically, the whaler is subsumed by the signal spread from a turbine, as shown in Figure 24. Approximately 5 scans (13 seconds) later, the whaler again becomes visible, as shown in Figure 25. Notice that in order to travel toward the fishing boat, the whaler must cross the sidelobes of the turbines perpendicularly, rather than travel along the sidelobes. Eventually, the ferry comes into radar range and becomes visible, as shown in Figure 26.

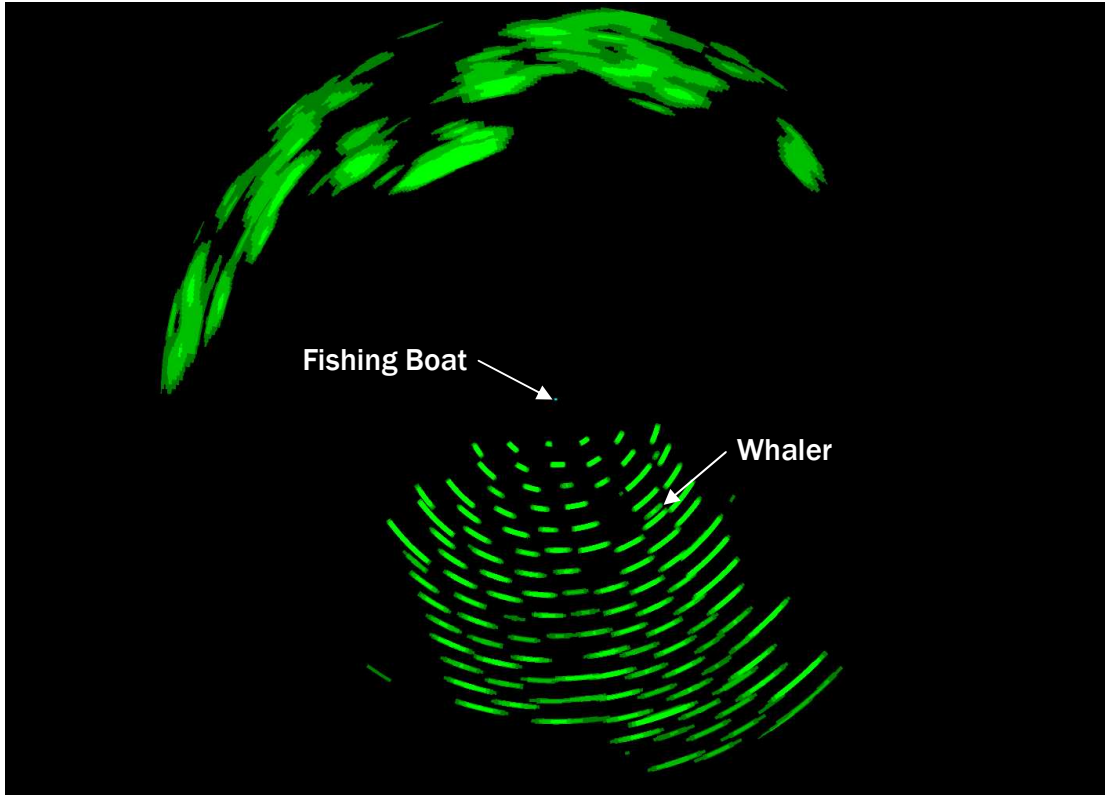

Figure 23: Six NMI Scan of Fishing Boat Radar 4:10 Before Meeting with Whaler

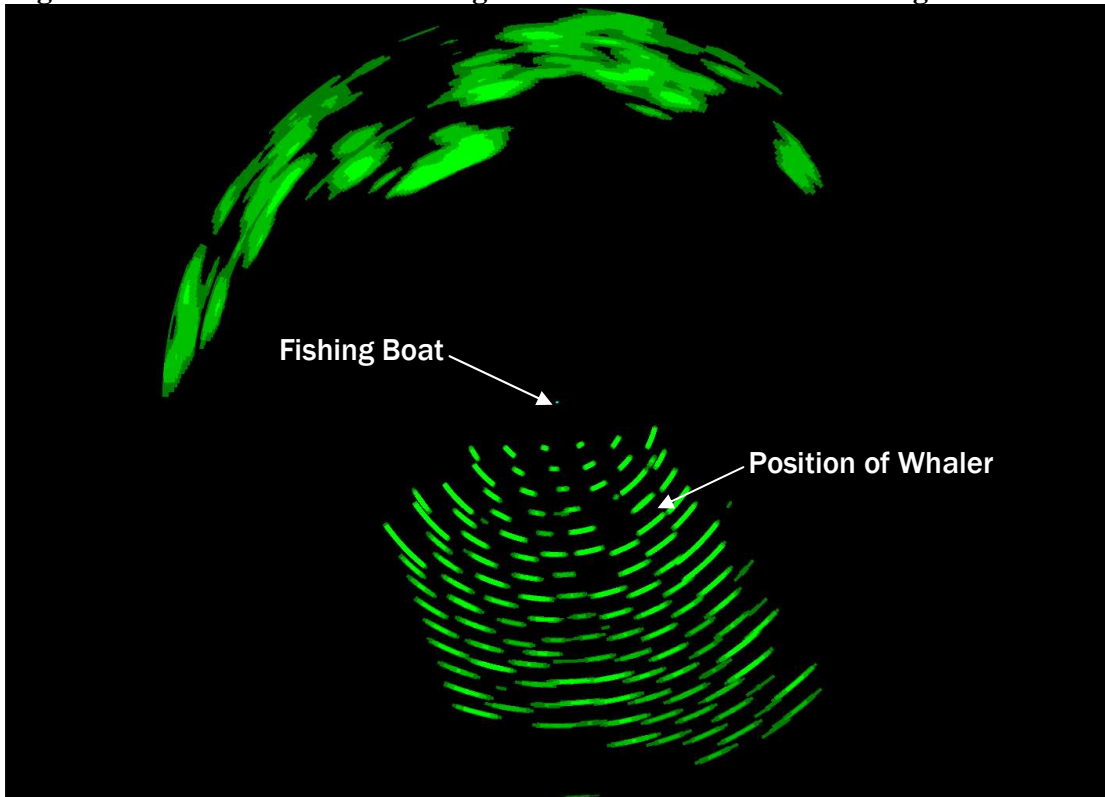

Figure 24: Six NMI Scan of Fishing Boat Radar 3:40 Before Meeting with Whaler

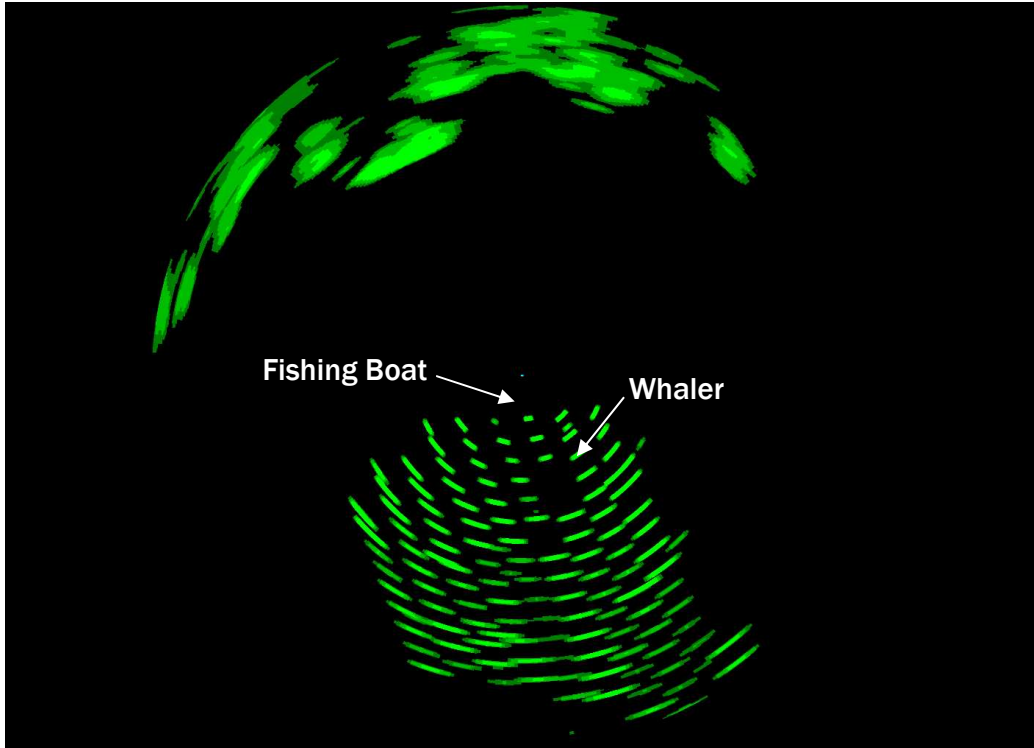

Figure 25: Six NMI Scan of Fishing Boat Radar 2:05 Before Meeting with Whaler

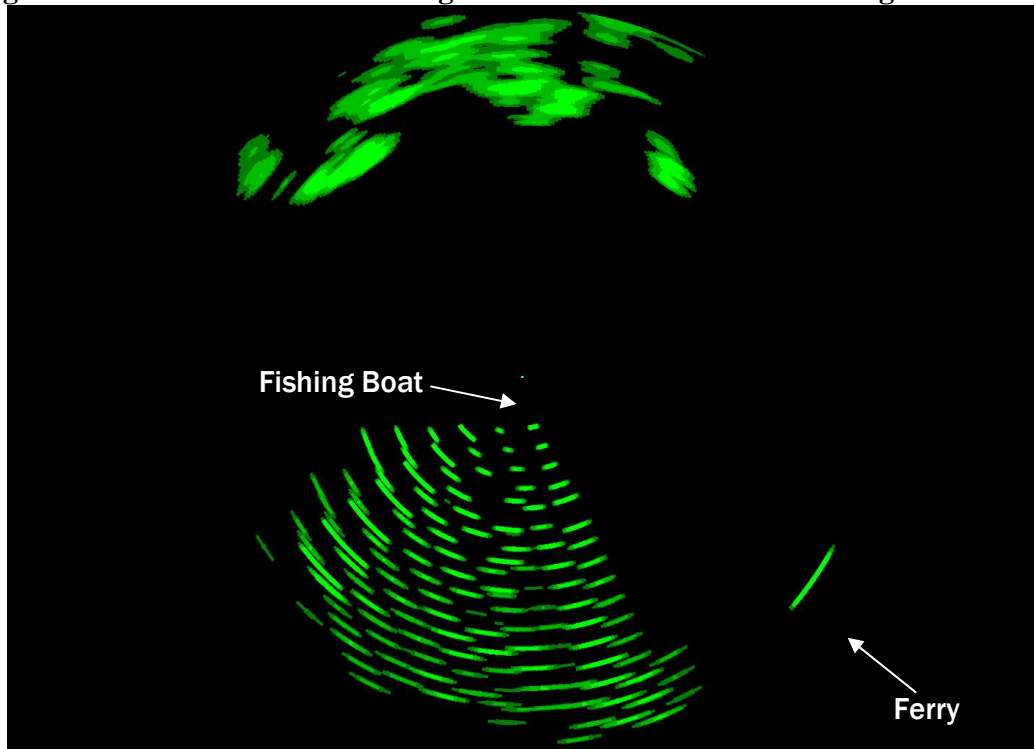

Figure 26: Six NMI Scan of Fishing Boat Radar After Ferry Comes Within Radar Range

Several of these scenarios were also run with weather conditions other than calm seas and no precipitation. Mist/fog conditions were run with the radars employing a fast time constant (FTC) type of precipitation rejection.

Scenario 1 from the oil barge/tug was rerun with mist conditions. A sample frame is shown in Figure 27. The whaler becomes more difficult to see under these conditions.

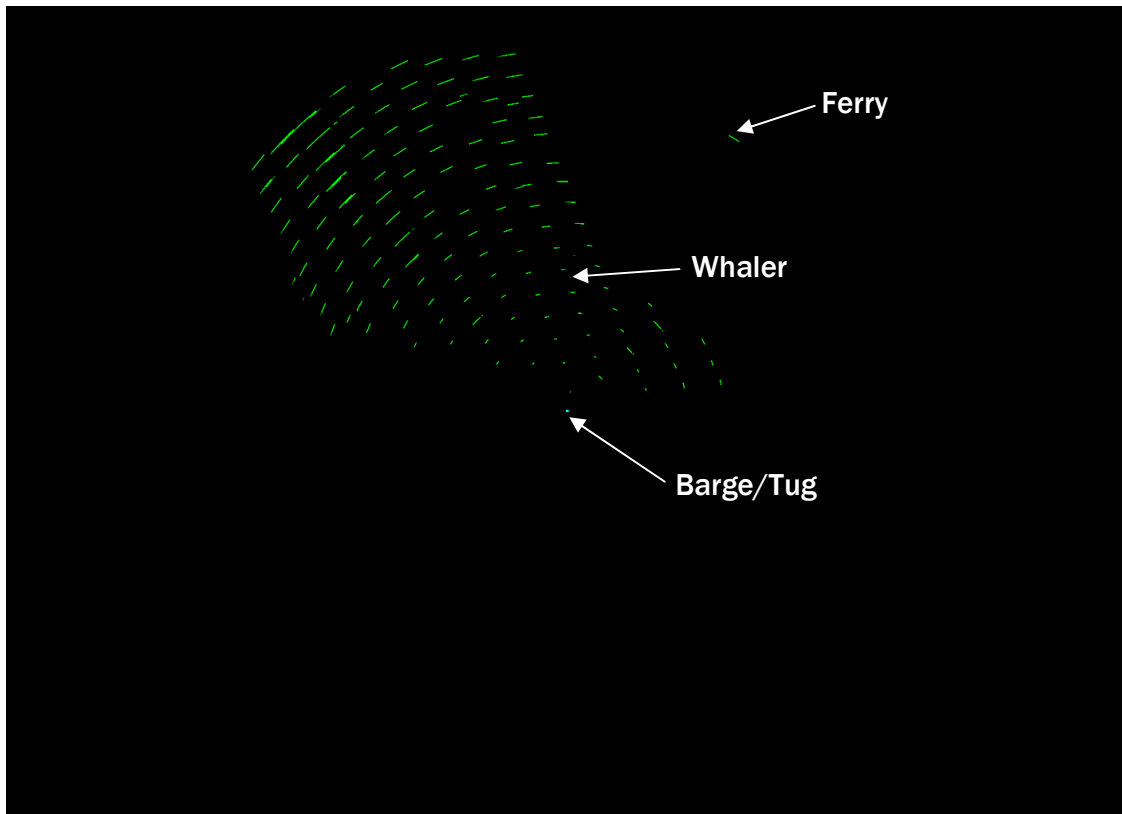

Figure 27: Six NMI Sample Radar Scan from Barge/Tug with Mist Conditions

Scenario 3 was also rerun with mist conditions. Figure 28 shows a sample frame. The results are similar to the clear weather conditions.

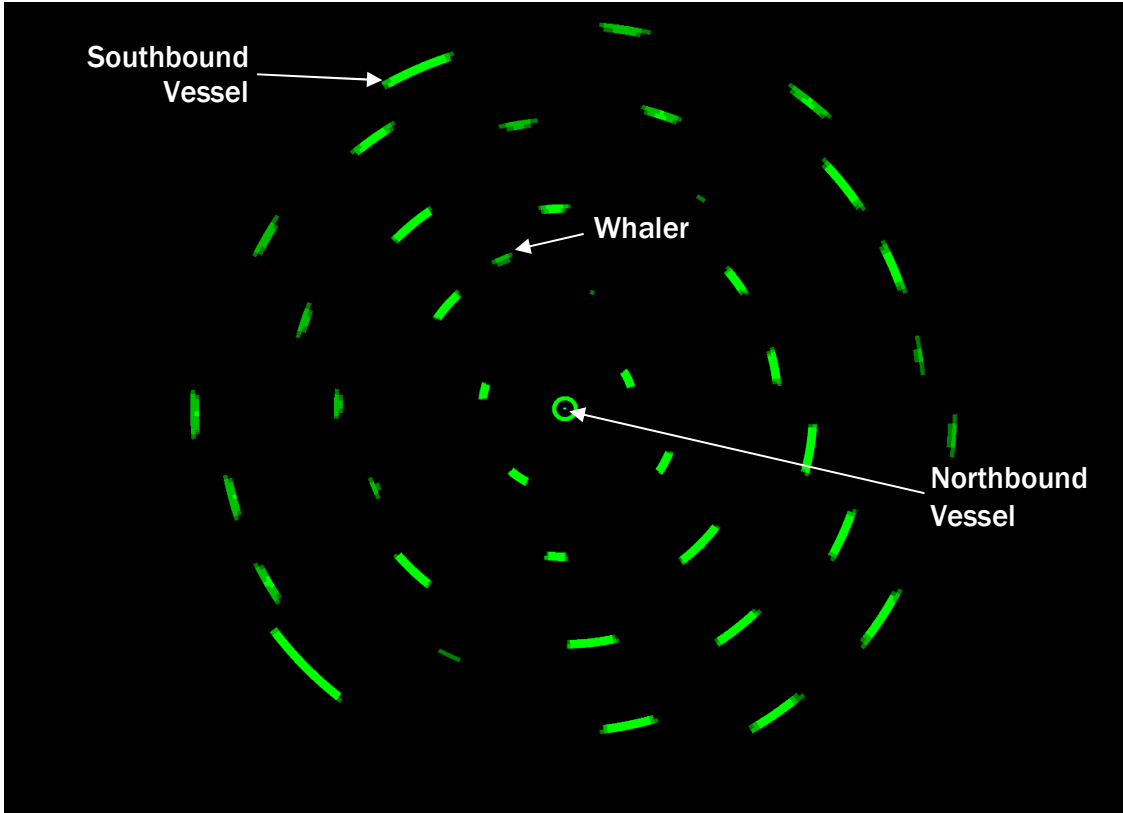

Figure 28: Sample 1.5 NMI Radar Scan from Northbound Fishing Boat in Mist

In addition to mist, rain and sea state 3 conditions were also run for Scenario 1. The FTC also tends to remove the sea clutter. Figure 29 shows a sample frame. Detection of the whaler under these circumstances is compromised. However, this would be true of an environment without turbines, also. The ferry remains visible under these conditions.

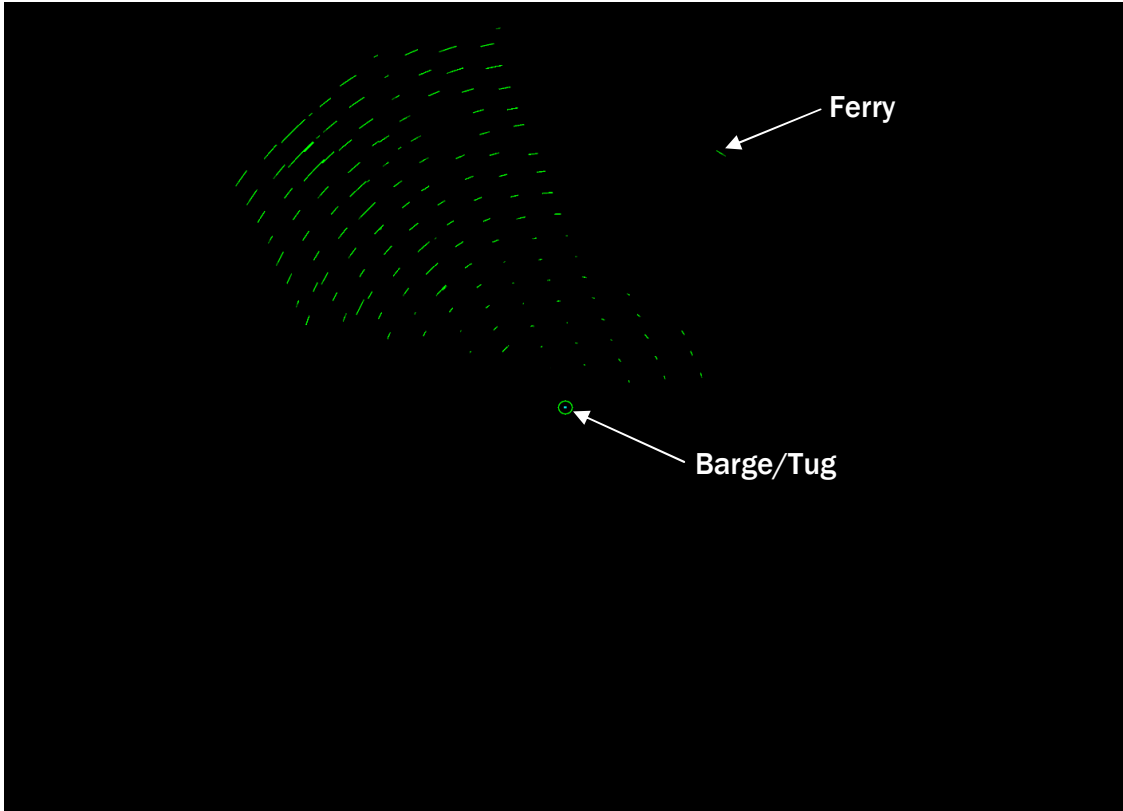

Figure 29: Sample Six NMI Radar Scan from Barge/Tug with Sea State 3 and Rain

7.0 Summary of Results

The various scenarios run show a variety of typical conditions that vessel radar operators will encounter while navigating in Nantucket Sound near and within the proposed wind farm. As expected, and as shown in the two documents by Marico and Brookner, the wind farm does have an effect on radar navigation. The scans of the predicted radar performance shown earlier in this report are an attempt to place the results in the context of actual and potential maritime operations in the Cape Wind environment.

It should be stated first of all that there is a difference between a target being visible and that target being noticeable. Except for transient periods of short duration, all targets of interest remained visible on the radar screen. It is not obvious, however, that all of these targets would be noticed by the radar operator without some mitigation techniques in either radar performance or maritime operations.

Targets outside the wind farm are easily detected and easily noticed. Targets within the windfarm, however, compete with numerous false targets caused by the turbines. These false targets are caused by a combination of sidelobes and secondary reflections. Of the two, the more distracting seem to be the secondary reflections.

The 130 turbines proposed for Nantucket Sound provide for a much greater number of potential false targets than the 30 wind turbines of Kentish Flats. Although a very small

percentage of these potential reflections actually result in “blips” on the screen, several of these blips do occur. It should be noted, however, that the vast majority of these secondary reflections occur past the opposite side of the wind farm or near the opposite side if within the wind farm. From simple geometry, no secondary reflection can occur closer than the second circle of wind turbines in any direction. Stated another way, for the proposed Cape Wind turbine layout, secondary reflections cannot occur within the first 1/3 nautical mile past any wind turbine from the radar. The number of potential secondary reflections close to the radar is small, but increases as the distance into the wind farm increases.

Additionally, as has been mentioned above in the various scenario discussions, the spreading in cross range of the signal from the turbines due to sidelobes/beamwidth also decreases with decreasing distance to the radar. Extremely broad spreading only occurs at the far side of the wind farm from the radar.

8.0 Mitigation

Several mitigation techniques can potentially be employed to reduce the effect of the turbines on radar. Radar mitigation techniques could include reducing the radar cross section (RCS) of the turbines and increasing the RCS of the vessels within or near the wind farm.

Increasing the RCS of vessels within the wind farm would increase the signal strength of the radar return from the vessel and result in a more visible vessel. However, since the main problem with the wind farm is not radar visibility, but noticeability, increasing the RCS of vessels would have only minor effect on navigational safety.

Decreasing the RCS of the wind turbines would tend to reduce the number of false targets present. Reductions of approximately 10-15dB in turbine RCS could be possible using a variety of techniques^[10]. However, false targets will still occur, since the turbines would remain significant reflecting objects.

Other mitigation strategies associated with radar navigation are outside the scope of this study.

References

- 1 *Assessment of Likely Effects on Marine Radar close to and within the Proposed Nantucket Sound Offshore Wind Farm*; Capt. D. Barber, Marine and Risk Consultants Limited (MARICO Marine Group); August, 2008.
- 2 *Deleterious Effects of Cape Cod Proposed Wind Farm on Marine Radars*; Dr. Eli Brookner; March 22, 2008.
- 3 *Radar Workshop, Cape Wind Proposal*; U.S. Coast Guard Sector Southeastern New England; October 7, 2008.
- 4 Almost any basic radar textbook, For example, *Introduction to Airborne Radar: Chapter 8*, George W. Stimson, 1983 has a very basic and visual description.
- 5 *Radar Navigation Manual, Pub. 1310, 3rd Edition*; Ernest B. Brown; 1979
- 6 *Results of the Electromagnetic Investigations and Assessments of Marine Radar, Communications and Positioning Systems Undertaken at the North Hoyle Wind Farm by Qinetiq and the Maritime and Coastguard Agency*; Martin Howard and Colin Brown; November 22, 2004.
- 7 *Bistatic Radar*; Nicholas J. Willis; Artech House; 1991.
- 8 *The Air Force Research Laboratory (AFRL) Mobile Diagnostics Laboratory (MDL) Wind Farm Turbine Measurements Fenner, New York Final Report*; Dr. Brian M. Kent, Alan ButerBaugh; July 20, 2006.
- 9 *The Radar Support System (RSS): A Tool for Siting Radars and Predicting Their Performance*; Lee Moyer, Alan Pieramico, David Rugger, Brian O'Hern; Proceedings of the IEEE 1997 National Radar Conference; May 1997.
- 10 *Stealth Technology for Wind Turbines Final Report*; Matt Bryanton, et. al; December 2007.

Advance Copy of USCG Findings and Mitigation

U.S. Department of
Homeland Security

United States
Coast Guard



Commander
First Coast Guard District

408 Atlantic Avenue
Boston, MA 02110
Staff Symbol: (dpw-3)
Phone: 617.223.8372
Fax: 617.223.8094
Email: Ronald.e.beck@uscg.mil

16670
30 December 2008

MEMORANDUM

From: D. G. GABEL, RADM
CGD ONE (d)

Reply to: Mr. Ron Beck
Attn of: 617-223-8372

To: COMDT (DCO)
Thru: LANTAREA (A)

Subj: ASSESSMENT OF POTENTIAL IMPACTS TO MARINE RADAR FROM THE
NANTUCKET SOUND WIND FACILITY AS PROPOSED BY CAPE WIND, LLC

1. I have reviewed enclosure (1) with my staff, and we concur with the assessment made by the Captain of the Port.

#

Enclosure: (1) CG SECTOR SENE memo 16670 of 30Dec08, forwarding Assessment of Potential Impacts to Marine Radar as it Relates to Marine Navigation Safety from the Nantucket Sound Wind Facility as proposed by Cape Wind, LLC., December 2008.

U.S. Department of
Homeland Security

United States
Coast Guard



Commander
United States Coast Guard
Sector Southeastern New England

1 Little Harbor Road
Woods Hole, MA 02543
Phone: 508.457.3267
Fax: 508.457.3236
Email: Raymond.J.Perry@uscg.mil

16670
30 December 2008

MEMORANDUM

From: R. J. PERRY, CAPT
CG SECTOR SENE

Reply to: Mr. LeBlanc
Attn of: 401-435-2351

To: COMDT (DCO)
Thru: (1) CGD ONE (d)
(2) CG LANTAREA (A)

Subj: ASSESSMENT OF POTENTIAL IMPACTS TO MARINE RADAR FROM THE
NANTUCKET SOUND WIND FACILITY AS PROPOSED BY CAPE WIND, LLC

Ref: (a) Sector Southeastern New England e-mail of 23Sep08, critique of the Minerals Management Service's (MMS) Cape Wind Energy Project Draft Environmental Impact Statement (DEIS)
(b) My memo of 29Sep08, Analysis of Potential Impacts to Coast Guard Missions of the Nantucket Sound Wind Facility as Proposed by Cape Wind LLC
(c) My memo of 31Oct08, Analysis of the Draft Environmental Impact Statement (DEIS) and Public Comments for the Nantucket Sound Wind Farm as Proposed by Cape Wind LLC
(d) Minerals Management Service's (MMS) Cape Wind Energy Project Draft Environmental Impact Statement (DEIS), January 2008

1. This is the fourth and final correspondence submitted for the Minerals Management Service (MMS) Final Environmental Impact Statement (FEIS) regarding potential impacts to navigation safety from the offshore renewable energy installation (OREI) proposed by Cape Wind LLC for installation in Nantucket Sound. References (a) through (c) are my previous deliberative process correspondence forwarded up the chain of command on the Cape Wind OREI proposal:
 - a. Reference (a) is my response with respect to the DEIS and comments to the DEIS from the public, passed via e-mail to MMS, copy to District and Headquarters, on 23 September 2008. This initial editorial markup of the navigation-related sections of the DEIS highlighted only typographical or other editorial errors, or clarified certain items such as notating throughout the document that Marine Safety Office Providence was part of a Coast Guard field reorganization and is now Sector Southeastern New England.
 - b. Reference (b) is my assessment of Cape Wind's proposed OREI on Coast Guard missions, and included an analysis of potential impacts to aviation search and rescue (SAR) by Air Station Cape Cod.

Subj: ASSESSMENT OF POTENTIAL IMPACTS TO MARINE RADAR FROM THE NANTUCKET SOUND WIND FACILITY AS PROPOSED BY CAPE WIND, LLC

- b. Reference (b) is my assessment of Cape Wind's proposed OREI on Coast Guard missions, and included an analysis of potential impacts to aviation search and rescue (SAR) by Air Station Cape Cod.
 - c. Reference (c) is my assessment of public comments regarding navigation safety and/or Coast Guard missions submitted to MMS in response to its DEIS. These public comments were provided to Sector Southeastern New England by MMS.
 - d. The analyses contained in references (b) and (c) were forwarded by Commandant (CG-5) via separate correspondence on 14 November 2008.
2. As stated in reference (c), the last remaining issue requiring further analysis is potential impacts of the proposed OREI to marine radar. This analysis was held pending receipt of a Coast Guard-sponsored study, which is included here as Appendix A to enclosure (1). That study, conducted by Technology Services Corporation (TSC) and entitled "Report of the Effect on Radar Performance of the Proposed Cape Wind Project" ("TSC study"), was commissioned by the Coast Guard in October 2008 and completed on 16 December 2008. It was prompted by conflicting findings in two previous radar reports that had been submitted to MMS and considered by the Coast Guard for that agency:
- (1) Deleterious Effects of Cape Cod Proposed Wind Farm on Marine Radars dated March 22, 2008, by Dr. Eli Brookner, also referred to as the "Brookner report", and
 - (2) Assessment of Likely Effects on Marine Radar Close to the Proposed Nantucket Sound Offshore Wind Farm of August 2008, ("MARICO study") commissioned by Cape Wind LLC.

Those two reports were briefed by their respective authors and discussed at length during a day-long workshop held on 7 October 2008 under the auspices of the Southeastern Massachusetts Port Safety and Security Forum where over twenty waterway users representing almost all user groups participated. The primary author of the TSC study was also present throughout the workshop. The objective of the TSC study was to model, through computer simulation, four different vessel traffic scenarios within the proposed OREI,¹ with representative radars used by vessels that routinely transit Nantucket Sound. The TSC study was also to provide an evaluation of the Brookner report and MARICO study based on the results of TSC's modeling of the wind farm and TSC's experience in radars. Prior to the study's completion I received two thorough briefings from TSC on 31 October and 1 December, 2008 on its progress and findings.

3. Enclosure (1) is my analysis of potential impacts to marine radar that may be caused by the presence of the proposed OREI. As further discussed in enclosure (1), there are sufficient

¹ Per the terms of the contract, the Coast Guard provided TSC with four vessel traffic scenarios to model. Each scenario is described in greater detail in enclosure (1), and within Appendix A thereto (the TSC report itself).

Subj: ASSESSMENT OF POTENTIAL IMPACTS TO MARINE RADAR FROM THE NANTUCKET SOUND WIND FACILITY AS PROPOSED BY CAPE WIND, LLC

mitigation measures available to reduce identified adverse impacts to navigation safety to an acceptable level. In my consideration of the mitigations that could be used, and their impact and effectiveness in reducing risk to an acceptable level, a qualitative process was employed. Quantitative processes were considered but determined to be less effective due to the qualitative type of results needed when addressing navigation safety in a given waterway with diverse users. The Coast Guard's navigation safety assessment is based on in-depth knowledge of the waterway and its surroundings, and users, and on the impacts the proposed project would likely have on navigation in Nantucket Sound. Consequently, similar to the analyses contained in references (b) and (c), I recommend that the impacts to marine radar from the proposed OREI be categorized as moderate. Per the impact categories set forth by MMS in reference (d), "moderate" is defined as:

- a. Impacts to the affected activity or community are unavoidable, and
 - b. Proper mitigation would reduce impacts substantially during the life of the proposed action, or
 - c. The affected activity or community would have to adjust somewhat to account for disruptions due to impacts of the proposed action, or
 - d. Once the impacting agent is eliminated, the affected activity or community would return to a condition with no measurable effects from the proposed action if proper remedial action is taken.
4. When addressing the use and effectiveness of potential mitigating measures or combination of measures the mitigations available were in some instances interdependent. Further, some potential measures were already included in regulation and only would need to be practiced within or in the vicinity of the wind farm; others are best required prior to construction; others will be considered during construction; and yet others after construction to better determine if the mitigations are necessary and how best to implement them. This approach recognizes that some mitigating measures could have a positive impact in one respect and a negative impact in another respect in terms of navigation safety or in terms of other uses of the waterway. Thus, an adaptive management approach was determined as the best approach to help ensure that the entire realm of available mitigations and their impacts were considered for both the safety of navigation and the protection of resources and other waterway uses. It should also be pointed out that as part of this adaptive approach, the categorization of moderate impact is contingent on the likely need for additional Coast Guard regulation, possibly in the way of a Regulated Navigation Area (RNA) for vessels operating within or in the vicinity of the proposed OREI. This adaptive management approach is consistent with the use of organic Coast Guard authorities, such as the Ports and Waterways Safety Act, as discussed in paragraph 1.b. of the Coast Guard Navigation Terms and Conditions.

#

Enclosure: (1) U.S. Coast Guard Assessment of Potential Impacts to Marine Radar as it Relates to Marine Navigation Safety from the Nantucket Sound Wind Facility as proposed by Cape Wind, LLC., December 2008

**U.S. COAST GUARD ASSESSMENT
OF POTENTIAL IMPACTS TO MARINE RADAR
AS IT RELATES TO MARINE NAVIGATION SAFETY
FROM THE NANTUCKET SOUND WIND FACILITY
AS PROPOSED BY CAPE WIND, LLC
DECEMBER 2008**

- Ref: (a) Commandant (CG-3) ltr of 2Aug07, Cape Wind Navigation Terms and Conditions
 (b) Cape Wind Revised Navigational Risk Assessment dtd 16Nov06
 (c) Commandant Instruction M16672.2 (series), Navigation Rules, International-Inland
 (d) Minerals Management Service's (MMS) Cape Wind Energy Project Draft Environmental Impact Statement (DEIS), January 2008

1. **Background:** The Coast Guard serves as one of 14 or so cooperating agencies providing input in our areas of expertise to the lead Federal agency, the Minerals Management Service (MMS). The Coast Guard is required to issue no permits other than private aids-to-navigation permits as per 33 CFR 66 for each wind facility tower. Per the Coast Guard and Maritime Transportation Act of 2006, the Coast Guard was required to provide reasonable Terms and Conditions for navigation safety to the MMS, which was accomplished via reference (a).
2. **Potential impacts of the proposed OREI to marine radar in Nantucket Sound:** The proposed OREI of 130 steel towers within a 24 square mile water sheet will impact marine radar. The question before the Coast Guard is to determine the severity of that impact, the subsequent effect, if any, on safe navigation, and if sufficient measures can be brought to bear to mitigate any adverse impacts such that navigation safety is maintained. Should those mitigation measures themselves have an adverse impact on some other component of maritime operations, that impact must also be assessed.
3. **Statistics:** The following table contains some of the specifics associated with the proposed wind farm as provided by Cape Wind Associates.

• 130 turbines	• 24 square miles: Area of wind facility
• 277.5': Height of Wind Turbine Generators (WTGs) above sea level	• 16.75': Diameter of WTG tower at sea level in water less than 40' deep • 18': Diameter of WTG tower at sea level in water 40' deep or greater
• 341': Blade diameter	• 75': Lowest point of blade to sea level
• 440': Highest point of blade above sea level	• Visibility in fog <2NM 10-18% of the time
• 5.6 miles: Closest point of land (Cotuit, MA)	• .34 x .54 nautical miles: Spacing between turbines
• 1166 yards: Closest point of wind facility to the centerline of the only federally maintained channel abutting the proposed OREI, Cross Rip Shoal Channel	• 214: Gallons of oil in each WTG • 27,820: Total gallons of oil in all WTGs combined
	• 42,000: Maximum number of gallons, oil, stored in tanks at the Electrical Service Platform (ESP)

Subj: ASSESSMENT OF POTENTIAL IMPACTS TO MARINE RADAR FROM THE NANTUCKET SOUND WIND FACILITY AS PROPOSED BY CAPE WIND, LLC

3. **Risk Assessment Methodology**: The Coast Guard Southeastern New England Captain of the Port's (COTP) initial direction to the applicant in 2002 was to prepare a qualitative risk assessment, and that approach has been reviewed—and affirmed—by subsequent COTPs. When analyzing as wide, varied, and complex an issue as navigation safety, even a quantitative risk assessment would require subjective assignment of numerical values to various risk and mitigation factors. Given the numerous variables of both risks and mitigations, a quantitative risk assessment would be of doubtful value. Given the abundance of professional expertise among the Coast Guard and maritime community, a qualitative risk assessment provided a thorough and comprehensive method of evaluating risk.

4. **Discussion on the use of Marine Radar and ARPA, and on Navigation and Navigation Rules**: Radar is one of many navigation tools. In general terms, radar displays on a screen the range, bearing, and relative motion of moving as well as stationary objects that are within range. It began to be used regularly on marine vessels near the end of World War II. It has become one of the more important instruments, particularly when visibility is restricted, in aiding a mariner to navigate safely and to avoid collisions. It is required on many vessels (see the table below), and its proper use is mandated. The use of available radar technology remains one of many tools employed by prudent mariners.

Type of Vessel	Radar Required? (General Answer)	Common Exception	Cite
Fishing Vessel	No	Yes, if employing 16 people or more	46 CFR 29.3
Recreational Vessel	No	Yes, if over 1600 GT	33 CFR 164
Foreign Mega-Yacht	No	Yes, if carrying 12 or more passengers	33 CFR 164
Ferry	Yes	No, if carrying 49 passengers or less	46 CFR Parts T & K
Towing Vessels	Yes	No, if vessel is less than 12 meters (39 feet)	33 CFR 164
Research Vessels	Yes	No, if vessel is less than 1600 GT	33 CFR 164

- a. An Automatic Radar Plotting Aid (ARPA) is a tool that enhances the radar display. ARPA calculates, among other things, a tracked object's course, speed and closest point of approach (CPA) thereby helping a mariner determine if there is a danger of collision with another vessel or landmass. Development of ARPA started after the accident in which the Italian liner SS ANDREA DORIA collided with the freight ship STOCKHOLM in dense fog and sank south of Martha's Vineyard. ARPA-enabled

Subj: ASSESSMENT OF POTENTIAL IMPACTS TO MARINE RADAR FROM THE NANTUCKET SOUND WIND FACILITY AS PROPOSED BY CAPE WIND, LLC

radars are now available even for small vessels. A typical ARPA gives a presentation of the current situation and uses computer technology to predict future situations. An ARPA computes relative movement between one's own vessel and a radar contact (or contacts), and enables an operator to see proposed maneuvers by one's own ship. ARPA is required on even fewer vessels than radar, and is typically required on larger commercial vessels. The ferries that operate between Cape Cod and the islands are equipped with ARPA.

To the extent the proposed wind farm would affect marine radar, it may also affect the performance of installed ARPA systems, and consequently ARPA's potential usefulness to operators. Like radar, though, ARPA is only one of many tools utilized by prudent mariners to ensure safe navigation.

- b. In general terms, navigation is the process of directing the movement of a craft, expeditiously and safely, from one point to another. Navigation involves art, math and science, and the tools and methods available for navigating continue to evolve. Regardless of navigation requirements, all vessel operators are expected to be prudent in navigating their vessel. Navigation safety is aimed at ensuring a vessel operator does not run aground, or collide with a fixed object. Radar is one of many tools used in navigation, but should not be relied upon solely.
- c. The Navigation Rules (the so-called "Rules of the Road") are the rules a vessel operator is required to abide by to avoid a collision with another vessel. The Convention on the International Regulations for Preventing Collisions at Sea, 1972, (COLREGS) as ratified by Congress and proclaimed by the President, *see* 33 U.S.C. 1601 *et. seq.*, and contained in reference (c), set forth the navigation rules applicable to where the wind farm is proposed. The applicability of a given rule is dependent on the type of vessel, or the activity it is engaged in, and the circumstances surrounding a vessel at a given time. This may include other traffic and their activities, weather, geography and proximity to designated channels to name a few. Radar and ARPA-enhanced radars are some of the many tools used in complying with the Navigation Rules, but should not be relied upon solely. *See* Rule 6 (noting that, in determining safe speed, vessels with radar must consider the characteristics, efficiency and limitations of radar); and Rule 7 (cautioning that, when assessing risk of collision, assumptions "shall not be made on the basis of scanty information, especially scanty radar information").
- d. The Coast Guard, in its analysis of the impact on navigation safety the proposed OREI may have on radar, has the expectation that vessel operators will comply with the COLREGS and all other applicable laws and regulations. Further, the Coast Guard performed its analysis with the expectation that mariners will be prudent in their vessel operation to include the proper and accepted practices of radar and ARPA use.

Subj: ASSESSMENT OF POTENTIAL IMPACTS TO MARINE RADAR FROM THE NANTUCKET SOUND WIND FACILITY AS PROPOSED BY CAPE WIND, LLC

5. **Waterway Users and their Concerns:** The following is a summary of the comments submitted to the MMS public docket concerning impacts on marine radar as it relates to navigation safety, categorized by waterway user groups. These comments, which include descriptions of various waterway users in Nantucket Sound, and their respective characteristics and concerns regarding any impact on radar and navigation safety, were also considered for the type and behavior of waterway traffic a radar operator may expect to discern using radar as a collision avoidance tool. Coast Guard responses are incorporated within some of the comments below, where appropriate.
- a. **Commercial Fishing and Research Vessels:** Currently, due to various economic reasons commercial fishing on Horseshoe Shoal (which is limited to certain times of the year, and certain species) is frequently conducted by a single vessel operator who both navigates from the pilothouse and operates fishing gear from the stern. That is, the single vessel operator leaves the pilothouse unattended for periods to tend to fishing gear behind the vessel, making it difficult if not impossible to properly monitor the vessel's radar. Although this practice does not conform to the COLREGS, it is common among certain segments of the commercial fishing community. Commercial fishing interest commenters were primarily opposed to the proposed OREI because of the following:
- (1) The presence of the towers will affect the manner in which they fish, not necessarily their ability to fish. Said another way, the proposed OREI will most affect commercial fishing in terms of economics, not safety. Clarifying comments from commercial fishermen to the Coast Guard after the Southeastern Massachusetts Port Safety and Security Forum's radar workshop suggested that commercial fishing could continue within the proposed OREI but, to ensure navigation safety among the 130 towers, a second person would have to be on the vessel and in the pilothouse at all times (in conformance with the COLREGS). Having a second hired hand onboard may render commercial fishing in Horseshoe Shoal unprofitable. Economic impacts are outside the purview of the Coast Guard's review of the proposal.
 - (2) There was also a concern that fishermen using towed gear amongst the towers would be impacted from a safety perspective due to the possibility of gear snags on the bottom resulting in their vessel being pulled into a tower, an obstruction that did not exist before. Although this could be linked to the use of radar, the subject of this recommendation, the avoidance of a tower should be no different than avoiding vessels in the area at anchor, aids to navigation or other fixed objects.
- b. **Recreational Boaters:**
- (1) Comments from, or pertaining to, recreational boaters were centered around one of two notions:

Subj: ASSESSMENT OF POTENTIAL IMPACTS TO MARINE RADAR FROM THE NANTUCKET SOUND WIND FACILITY AS PROPOSED BY CAPE WIND, LLC

- (a) As a group, recreational boaters are too incompetent, reckless, or both, to be able to safely navigate through the proposed OREI, or
 - (b) The average recreational boater will be able to effectively navigate through the proposed OREI without significant difficulty.
- (2) One argument made by some regarding recreational boaters is that the proposed OREI would make it less convenient to navigate within the Horseshoe Shoal area of Nantucket Sound, and some recreational boaters may decide to avoid the wind farm footprint altogether and use existing channels and travel lanes around the Shoals.
- c. **Passenger Ferries:** Both high-speed and traditional ferries frequent Nantucket Sound. There are (uncharted) ferry routes on each side of the triangle-shaped proposed OREI for transits between Hyannis on the mainland and the island of Martha's Vineyard and Nantucket. The two major ferry operators are the Woods Hole, Martha's Vineyard and Nantucket Steamship Authority (Steamship Authority), a quasi-State-governmental organization, and its licensee, Hy-Line Ferry, which operates high speed ferries only.
 - (1) One concern of the ferry operators is the ability to detect, by radar, vessels transiting on the other side of the proposed OREI. The TSC study, consistent with data in the other existing studies, showed that radar detection of vessels outside the proposed OREI was not severely impacted.
 - (2) Ferry operators were also concerned about small vessels, undetected on ferry radars, exiting the proposed OREI and crossing one of the ferry routes adjacent to the proposed OREI. The TSC study showed that vessels outside the proposed OREI (such as ferries) could detect small vessels within the proposed OREI, but discerning such vessels would require greater operator attention.
 - (3) Similarly, ferry operators expressed concern that the proximity of their frequent transit routes to the wind farm would make already difficult to detect (small) targets, more difficult to discern or track within or as they exit the proposed wind farm.
 - (a) The Coast Guard finds that the distance of the ferry routes to the east are sufficiently separated from the proposed OREI to result in few radar impacts.
 - (b) Similarly, the Coast Guard finds that the distance of the ferry routes to the south are sufficient even in the main channel (adjacent to the proposed OREI). Through interviews of ferry captains operating between Martha's Vineyard and Nantucket it was learned that many ferries operate outside and to the south of the main channel to avoid Horseshoe Shoal altogether.
 - (c) The distance of the ferry routes to the northwest of the proposed OREI are also considered sufficient, especially when considering that only highly-maneuverable high-speed ferries operate on this route, and the proposed OREI

Subj: ASSESSMENT OF POTENTIAL IMPACTS TO MARINE RADAR FROM THE NANTUCKET SOUND WIND FACILITY AS PROPOSED BY CAPE WIND, LLC

in that vicinity is in the most shallow area of Horseshoe Shoal where ferries already take precautions to remain a safe distance away.

- (4) Another closely related, stated concern of ferry operators was that in poor weather, with winds from due west or due east, ferries transiting between Hyannis and Nantucket must “tack” into or against the prevailing wind to provide a safer and more comfortable ride. These tacking maneuvers purportedly require ferries to transit close to, if not within, the proposed OREI, thus potentially lessening reaction times for collision avoidance with any contact operating within or exiting the proposed wind farm should the presence of the wind turbines themselves limit the ability to use radar to detect and track contacts operating therein.

Track-lines provided from ferry operators did show that the ferries on occasion may make a tack into the wind farm; however, the greatest intrusion was approximately a half mile. Considering the space available to the east for tacking, and the half mile intrusion into the proposed OREI area is only a small portion of any leg of a tack, ferry operators should be able to adjust their tacks with minimal impact. The wind towers may also provide a visual reference to aid in ensuring a ferry stays well clear of the shoals during such maneuvers. Prior to receiving the above information, the Coast Guard reviewed two years of written logs from six individual ferries and could not find a single indication of a ferry tacking. In interviews of ferry captains, one claimed that he did tack frequently in poor weather and his tacking track line would take him into the area of the proposed OREI. Other ferry captains were familiar with the tacking maneuver, but one said he had tacked only once in the past two years, and no other ferry captain claimed the tacking maneuver would take him into the area of the proposed OREI. One retired ferry captain indicated his awareness of the tacking maneuver during poor weather, but claimed that even when tacking, the ferry did not approach the area of the proposed OREI.

- d. **Tug and Barge Operators:** The tug boat and barge operators, as well as research ships that operate regularly out of Woods Hole, did not express specific concerns.
- e. **Cruise Ships:** Large cruise ships did not express specific concerns. These ships do enter the area, but generally do not enter the channels adjacent to the proposed OREI. Cruise ships typically enter from the southwest along Vineyard Sound between the Elizabeth Islands and Martha’s Vineyard, anchoring north of Martha’s Vineyard. They depart the area along a reverse route.
- f. **Other Deep Draft Ships:** No deep draft shipping interests outside the cruise ship industry commented on the proposed OREI. No known such interests operate in Nantucket Sound itself.

Subj: ASSESSMENT OF POTENTIAL IMPACTS TO MARINE RADAR FROM THE NANTUCKET SOUND WIND FACILITY AS PROPOSED BY CAPE WIND, LLC

6. **The Radar Studies:**

- a. The documents used in determining the impact of the proposed OREI on marine radars included, but were not limited to, the following:
 - (1) Report of the Effect on Radar Performance of the Proposed Cape Wind Project dated December 16, 2008. Developed by Technology Service Corporation (TSC) under contract by the U.S. Coast Guard
 - (2) Assessment of Likely Effects on Marine Radar Close to the Proposed Nantucket Sound Offshore Wind Farm prepared for Cape Wind Associates LLC, Ref. No: 08-656 dated August 2008 by Marico Marine
 - (3) Results of the Electromagnetic Investigations and Assessments of Marine Radar, Communications and Positioning Systems Undertaken at the North Hoyle Wind Farm by QuinetiQ and the Maritime and Coast Guard Agency (of the United Kingdom) dated November 22, 2004.
 - (4) Deleterious Effects of Cape Cod Proposed Wind Farm on Marine Radars dated March 22, 2008, by Dr. Eli Brookner. (The "Brookner report")
- b. The research into the impacts of wind farms on marine radars is fairly consistent in finding that the radar observer will be presented with a more complicated and, at times, confusing navigational picture. There are three primary contributors to this more complicated picture: (1) beam width expansion; (2) side lobes; and (3) false echoes; all of which are also experienced without the presence of a wind farm.² The vertical extent of the tower, the shape and complexity of the nacelle, the orientation of the nacelle, and the orientation of the blades, all contribute to a changing, but generally large, radar cross section (RCS). This results in strong radar target reflections.
- c. As described in the TSC report, all radar antennas have a beam width that causes a target to expand in azimuth as the range from the antenna increases. Generally, smaller antennas have wider beam widths and greater target expansion. All of the referenced studies show radar presentations that demonstrate this effect.
- d. Side lobe reflections, also a function of radar antenna design, become more of an issue when the RCS of a target is large. They add to the width of the target presentation because they are perpendicular to the radar beam. As described in the TSC report, side lobe reflections are relatively small for modern radar antennas, even for the low-end radar sets modeled by TSC. The TSC and MARICO studies consider side lobe reflections to be a relatively small contributor to the overall challenge of navigating in and around an

² The phenomena of "shadowing" (or "blind spots"), involving a target being undetected behind a wind turbine, is discussed in the referenced reports. For moving targets and moving observing vessels, shadowing is considered to be transitory and generally less of a problem than false echoes, beam width expansion, and side lobes.

Subj: ASSESSMENT OF POTENTIAL IMPACTS TO MARINE RADAR FROM THE NANTUCKET SOUND WIND FACILITY AS PROPOSED BY CAPE WIND, LLC

OREI, while the Brookner report argues that side lobes will have a much greater impact.

- e. According to the TSC report, false echoes are produced when the radar beam bounces off the initial target to another target (or targets), is reflected back to the antenna, and then shows up as a spurious echo or echoes beyond the initial target. Depending on the geometry of the wind farm or other strong targets such as a large vessel, these spurious echoes may present numerous “blips” to be evaluated. Fortunately, these false echoes are transient and tend to disappear or move as the observing vessel or target vessel moves. This makes the observer’s task of evaluating targets easier.
- f. The referenced radar studies all show some radar presentations with a combination of beam width expansion, side lobes, and false echoes that are difficult to interpret. Actual targets may be temporarily lost in the beam width and side lobes, especially as the range to the target increases. Fortunately, the targets of greatest concern are generally those that are closest, where the beam width and side lobes are smaller.
- g. The MARICO assessment argues that the false echoes presented near a wind farm are often a result of shipboard structures that reflect strong radar returns, either from a wind farm, another vessel, or another offshore structure such as the WW II fort in the Kentish Flats area. This report further supports this argument with the observation that approximately 30% of the vessels studied did not experience a large number of false echoes. The TSC study did not model shipboard interfering structures, but found that false echoes occur due to reflections from one turbine to another. There is no disagreement, however, that false echoes do occur and that they may be more numerous when there are a number of targets with large RCSs
- h. The report of the TSC study indicated the following:
 - (1) The proposed OREI would not adversely impact the ability of a vessel outside the wind farm to detect, by radar, another vessel outside the wind farm, even if portions of the wind farm are between the two vessels.
 - (2) The proposed OREI would not adversely impact the ability of a vessel inside the wind farm to detect, by radar, a vessel outside the wind farm.
 - (3) The proposed OREI would impact a vessel outside the wind farm in its ability to detect, by radar, a vessel within the wind farm. Vessels within the wind farm are generally discernible, but the radar operator will likely have to pay closer attention to the radar scope to distinguish between a valid and false radar return.
 - (4) The proposed OREI would likely impact a vessel’s ability, when inside the wind farm, to detect, by radar, another vessel within the wind farm. Again, vessels within the wind farm are discernible, but the radar operator will need to pay close attention to the radar scope to distinguish between a valid and false radar return.

Subj: ASSESSMENT OF POTENTIAL IMPACTS TO MARINE RADAR FROM THE NANTUCKET SOUND WIND FACILITY AS PROPOSED BY CAPE WIND, LLC

- (5) Of particular note is the finding in the TSC report that the primary radar reflector (or radar cross-section) of a WTG is not the 277.5-foot tower, nor the 341-foot diameter blades, but the sharp-edged, multi-faceted nacelle that sits atop the turbine. Interestingly, the TSC study showed that as a vessel moves closer to a WTG its radar picture improves around those towers closest to it, i.e., the radar picture in the immediate vicinity of a vessel, even within the wind farm, is clear. As a vessel gets closer to a tower (or towers), the nacelles of the adjacent towers are too high to be reflected by the vessel's radar signal, and so cannot return as strong a reflection. It is the towers that are further away (and whose nacelles are within the radar signal) that cause greater beam width spread and provide more spurious echoes due to having more WTGs to reflect from as the radar "looks" deeper into the wind farm.

7. The Coast Guard Findings:

- a. The Coast Guard concurs with the findings of the TSC modeling study as stated in paragraph 6.h above. After considering these findings, the Coast Guard considered how the wind farm impacts to radar would affect a vessel operator in making navigation and collision avoidance decisions. The Coast Guard finds that vessels would be able to navigate safely within and in the vicinity of the proposed OREI, and that the impact of the proposed OREI on navigation safety is "moderate." This assessment assumed a vessel operator is in a restricted visibility situation and is complying with the COLREGS as well as operating his/her vessel prudently. The Coast Guard recognizes that the human factors involved with respect to an operator/radar observer performing multiple tasks, at times, may present target detection challenges along with an "eyes-busy" and "hands-busy" situation. These findings take into account the reality of short-handed or single-handed operation and the fact that certain vessel operators will be more challenged than others when navigating under conditions of reduced visibility. The following findings from the TSC study and associated principles were considered important:
- (1) Since side lobes and target expansion tend to be more of a problem at some distance from the radar than close in, vessels in the vicinity of the radar may be detected more easily than vessels some distance away. Operators in the vicinity of the proposed OREI should have little problem identifying vessels nearby that could pose a threat of collision in time to react to that contact. Contacts located where target expansion and side lobes become problematic are generally at a distance so as not to be of significant concern.
 - (2) Although the radars on vessels within the proposed OREI should detect other targets within the proposed OREI in time for an operator to take action to avoid a collision, it is recognized that the combination of multiple vessel contacts with the returns of multiple towers appearing for 360 degrees on the radar screen would likely impact a operator's ability to notice and track targets of concern. In other words, it would require a level of attention from operators inside the proposed OREI that is problematic for the radar to be as effective a collision avoidance tool as would

Subj: ASSESSMENT OF POTENTIAL IMPACTS TO MARINE RADAR FROM THE NANTUCKET SOUND WIND FACILITY AS PROPOSED BY CAPE WIND, LLC

normally be expected under external OREI navigation in restricted visibility.

- b. Keeping the findings of the TSC report (impact on marine radar itself) and the potential impacts on waterways users described above in mind, the Coast Guard finds the following:
 - (1) The proposed OREI would not significantly adversely impact the ability to safely navigate a vessel outside the wind farm or to detect, by radar, another vessel outside the wind farm, even if the wind farm is between the two vessels.
 - (2) The proposed OREI would not significantly adversely impact the ability of a vessel inside the wind farm to detect, by radar, a vessel outside the wind farm.
 - (3) The proposed OREI would significantly adversely impact the ability of a vessel, while outside the wind farm, to detect, by radar, a vessel within the wind farm. Vessels within the wind farm would be discernible, but the radar operator will likely have to pay closer attention to the radar scope to distinguish between a valid and false radar return. Mitigations to aid in avoiding collisions would be needed to offset this impact.
 - (4) The proposed OREI would significantly adversely impact the ability of a vessel, while inside the wind farm, to detect, by radar, another vessel within the wind farm. Again, vessels within the wind farm would be discernible, but the radar operator would need to pay closer attention to the radar scope to distinguish between a valid and false radar return. Mitigations to aid the mariner in avoiding collisions would be needed to offset this impact were the wind farm to be approved by MMS.

8. **Potential Mitigations:**

- a. With the foregoing radar analysis and findings as background, the Coast Guard next examined what mitigation measures, if any, might reduce risks to the safety of navigation. Various documents already require or propose measures to mitigate adverse impacts, including impacts to marine radar. The Coast Guard's Terms and Conditions developed for this proposed OREI allow for an adaptive management approach, recognizing that many of the mitigations and specific application of mitigations would be best determined during or after construction. Thus, our assessment and recommendation to MMS as to the proposed OREI's impact on radar and subsequently on safe navigation was limited to identifying if reasonable mitigations are available to reduce the risks of any impacts. The Coast Guard has determined that there are reasonable mitigations available.
- b. It would be premature to discuss detailed and finite mitigation measures at this point in the permitting process for the proposed Cape Wind OREI. However, in developing the foregoing assessment and recommendation, the Coast Guard considered the following:

Subj: ASSESSMENT OF POTENTIAL IMPACTS TO MARINE RADAR FROM THE NANTUCKET SOUND WIND FACILITY AS PROPOSED BY CAPE WIND, LLC

- (1) Reference (a) contains a number of mitigation measures, primarily requirements for Cape Wind to maintain certain operational oversight, communications, and monitoring capabilities, including the capability to “monitor in real time marine traffic within and in the vicinity of the Nantucket Sound Wind Farm.” Plans for achieving these capabilities must be submitted by Cape Wind LLC before beginning construction of its proposed OREI, and those plans must be approved by MMS after consultation with the Coast Guard.
 - (2) Reference (c), which includes the International Regulations for Preventing Collisions at Sea (COLREGS), commonly referred to as the “Rules of the Road,” sets forth Federal requirements governing vessel operation, movement, and collision avoidance in both international and inland waters. (The site of the proposed Cape Wind OREI is in international waters.) The COLREGs contain a variety of required measures to mitigate hazards to navigation, such as proceeding at safe speed for the prevailing circumstances, maintaining a proper continuous lookout, etc. Full compliance with the COLREGS is expected, and the COLREGS are considered a valid, and primary, measure to mitigate potential radar impacts within and in the vicinity of the proposed OREI.
 - (3) The Captain of the Port has several regulatory and non-regulatory avenues available to enhance and protect navigation safety. Possibilities include creation of a specially marked channel (or channels) through the proposed OREI, creation of special “Recommended Vessel Routes” such as those currently in use in Buzzards Bay, and/or creation of a Regulated Navigation Area to govern, or a voluntary system to help manage, speed, traffic patterns, communications, etc. within and in the vicinity of the proposed OREI, particularly under conditions of reduced visibility. One potential application of Coast Guard authorities would be to implement a Regulated Navigation Area that proscribes something similar to Rule 9’s requirements for narrow channels, whereby vessels operating within any wind farm “shall not impede” the passage of vessels operating in the vicinity of, but outside of, the wind farm. It is anticipated that were the proposed wind farm to be approved by MMS, the precise details of any such mitigation strategies would be further developed and refined with continued input from waterway users, through venues such as the Southeastern Massachusetts Port Safety and Security Forum, and potentially, through future formal Coast Guard rulemaking procedures, or through other Coast Guard processes.
- c. The Coast Guard has reviewed over two dozen potential mitigation measures that were identified as possibly applicable in the course of this assessment, ranging from the COLREGS to general education of Federal navigation safety requirements, and has determined that this mitigation “toolbox” – including those requirements set forth in the Coast Guard’s Terms and Conditions – provides the Captain of the Port sufficient means to reduce risk to navigation safety substantially. Affected waterways users may need to adjust somewhat to account for navigating within, and in the vicinity of, the proposed OREI. Nevertheless, vessels operating within or near the proposed OREI should be able

Subj: ASSESSMENT OF POTENTIAL IMPACTS TO MARINE RADAR FROM THE NANTUCKET SOUND WIND FACILITY AS PROPOSED BY CAPE WIND, LLC

to do so safely even in restricted visibility. Although there may be degradation in the effectiveness in the use of radar, radar is not the only measure a mariner has at his/her disposal or should be using. Due to the unique operating environment that the wind farm presents, all of the possible mitigations available will be assessed and, if deemed appropriate, required of Cape Wind in accordance with the Terms and Conditions. Some of the mitigations associated with the proposed OREI include 13 specific mitigation measures proposed by Cape Wind LLC in Section 7.0 of reference (b). Those related to navigation safety were focused primarily on aids to navigation (light, signals, etc.) and public education and outreach. Cape Wind's proposed aids-to-navigation system is graphically displayed in Figure 4-17 to reference (b).

- d. Given the risk mitigation strategies and tools discussed above, and the characteristics of the waterway users in Nantucket Sound, buffer zones are not needed. This is significant in determining the impact on navigational safety for this project because of the channels that exist along the borders of the proposed OREI and the associated obstructions, many marked by aids-to-navigation, that are near the edges of these channels. Two factors came into play in making the determination that buffer zones are not needed. First, for vessels transiting in the vicinity of the proposed OREI, the impact on radar was minimal for the distances an operator would need to track and make navigational decisions. The other reason is that deep draft vessels do not operate in the vicinity of the proposed OREI. Unlike the vessels that do operate in the vicinity of the proposed OREI, which need relatively short distances to maneuver, deep draft vessels need significantly greater areas to maneuver due to stopping distances, turning radius, etc. This circumstance does not exist in Nantucket Sound.
- e. Consequently, the Coast Guard's assessment of impact on navigation safety falls within the "moderate" impact level as defined in reference (d).
- f. It is important to keep in mind that a key component to any potential future mitigation measure —perhaps the key component—is waterway user input. It is difficult, if not impossible, to engage waterway users in a constructive dialogue regarding potential mitigation measures and their expected effectiveness before knowing whether or not the proposed OREI is approved. The lead Federal agency, MMS, advocates an "adaptive management" approach to the permitting process. Between issuing an initial lease/permit and actual construction of the proposed OREI, technical, economic, or other factors may change the complexion of the proposed OREI and/or the character of mitigations. The Coast Guard stands ready to continue its dialogue with the public, waterway stakeholders, and cooperating agencies should MMS grant any lease, easement, or right of way for the OREI proposed by Cape Wind.

#

Appendix A: Report of the Effect on Marine Radar Close to the Proposed Cape Wind Project (TSC Study)