

OCS STUDY
MMS91-0017

FINAL FIELD REPORT

**AERIAL SURVEYS OF ENDANGERED WHALES IN THE ALASKAN CHUKCHI AND
WESTERN BEAUFORT SEAS, 1990**

JUNE 1991

Prepared for:

**MINERALS MANAGEMENT SERVICE
ALASKA OCS REGION
U.S. DEPARTMENT OF INTERIOR
ANCHORAGE, ALASKA 99508-4302**

Prepared by:

**Sue E. Moore and Janet T. Clarke
SAIC, Maritime Services Division
2845-D Nimitz Blvd.
San Diego, CA 92106**

This study was funded by the Alaska Outer Continental Shelf Region
of the Minerals Management Service, U.S. Department of the Interior,
Washington, D.C., under Contract No. 14-35-001-30468

Cite as: Moore, S.E. and J.T. Clarke. 1991. Aerial surveys of endangered whales in the Alaskan Chukchi and western Beaufort seas, 1990. OCS Study MMS 91-0017, Final Field Report prepared for the U.S. Minerals Management Service, Alaska OCS Region, prepared by Science Applications International Corporation (SAIC), Maritime Services Division, 96 pp.

DISCLAIMER

This report has been reviewed by the Alaska Outer Continental Shelf Region, Minerals Management Service, U.S. Department of the Interior and approved for publication. The opinions, findings, conclusions or recommendations expressed in this report are those of the authors, and do not necessarily reflect the views of the Minerals Management Service. Mention of trade names or commercial products does not constitute endorsement or recommendation for use. This report has not been edited for conformity with Minerals Management Service editorial standards.

PROJECT ORGANIZATION AND ACKNOWLEDGEMENTS

This report is an account of the second year of a three-year field study of endangered whales in the Alaskan Chukchi and western Beaufort seas conducted by Science Applications International Corporation (SAIC), Maritime Services Division for the U.S. Minerals Management Service (MMS), Alaska Outer Continental Shelf (OCS) Region. The report describes results from field work conducted in October and early November 1990. These results are subsequently integrated with results obtained from this study in 1989 and from similar studies conducted by the Naval Ocean Systems Center and SAIC, Maritime Services Division (formerly SEACO/SAIC) from 1980-88.

At the MMS, Anchorage, AK, we appreciate the support of J. Montague, J. Imm, C. Cowles, and S. Treacy. For logistic support, we are especially grateful to pilots D. Moore, D. Henley, G. Candee, and J. Gustafson of the Office of Aircraft Services (OAS), and E.J. Fish and C. Wesen of Evergreen Twin Otters, as well as the administrative and maintenance staffs at OAS and Evergreen. We also thank the staff at the Barrow Airport Inn, Barrow, AK, and at the Arctic Caribou Inn, Deadhorse, AK, for their assistance during field operations. M. Johnson and M. Newcomer (SAIC) were excellent field observers and aided in the acquisition of all data upon which the results of this study rest. S. Hooton and R. Wilkinson (SAIC) provided graphics and illustrations. R. Smith, R. O'Hara, J. Malo and J. Bennett (SAIC), and J. Dunlap (MMS) provided data collection and analyses software. J. Candler and J. LaNell (SAIC) assisted in travel logistics and report preparation. Our thanks to all.

This page intentionally left blank.

CONTENTS

	page
PROJECT ORGANIZATION AND ACKNOWLEDGEMENTS	i
TABLE OF CONTENTS	ii
ACRONYMS AND ABBREVIATIONS	viii
EXECUTIVE SUMMARY	ix
INTRODUCTION	1
Objectives	4
METHODS AND MATERIALS	5
Project Rationale and Design	5
Study Area and Aerial Survey Procedure	6
Data Analysis	8
Distribution and Abundance	8
Migration Route	11
Calf Sightings	11
RESULTS	12
Survey Effort and Conditions	12
Bowhead Whale (<i>Balaena mysticetus</i>)	17
Distribution and Abundance	17
Other Marine Mammals	21
Gray Whale (<i>Eschrichtius robustus</i>)	21
Belukha (<i>Delphinapterus leucas</i>)	21
Walrus (<i>Odobenus rosmarus</i>)	23
Polar bear (<i>Ursus maritimus</i>)	23
DISCUSSION AND REVIEW	28
Survey Effort and Conditions	28
Bowhead Whale	29
Distribution and Abundance	29
Migration Route	35
Calf Sightings	43
Other Marine Mammals	44
Belukha	44

	page
LITERATURE CITED	48
APPENDIX A	A-1

Aerial Survey Flight Tracks, Survey Captions, and Endangered Whale
Sighting Summaries, 1990

FIGURES

	page
1. Study area depicting the boundaries of the Chukchi and Hope Basin OCS Planning Areas, and the westernmost portion of the Beaufort Sea OCS Planning Area	2
2. Survey blocks derived for the study area	7
3. Example of an aerial survey flight track depicting transect, connect and search survey legs	10
4. Composite flight tracks depicting 1990 flight effort: 2 surveys, 3-10 October (A); 11 surveys, 11-20 October (B); 7 surveys, 21-31 October (C); 6 surveys, 1-7 November (D); and 26 surveys, 3 October - 7 November (E)	14
5. Approximate location of the ice edge ($\geq 90\%$ ice cover) during the 1990 season	16
6. Distribution of 14 sightings of 19 bowhead whales relative to OCS lease areas, 1990	18
7. Distribution of 7 sightings of 41 bowhead whales from the NOAA research vessel <u>Surveyor</u> , October 1990	21
8. Distribution of 60 sightings of 110 belukhas, 1990	22
9. Distribution of 178 sightings of 1,319 walruses, 1990	25
10. Distribution of 41 sightings of 53 polar bears, 1990	26
11. Chukchi Sea ice-edge frequency map for the second week of October, derived from a 12-year (1972-83) satellite database (from Stringer and Groves 1987)	30
12. Cumulative (1982-90) bowhead whale distribution depicting 46 sightings of 187 whales, 16-30 September (A); 132 sightings of 246 whales, 1-15 October (B); 62 sightings of 87 whales 16-31 October (C); and 240 sightings of 520 whales (D)	31
13. Cumulative (1982-90) bowhead whale relative abundance by sub-block	34
14. Cumulative (1982-90) bowhead whale swimming direction in the western Beaufort and northeastern Chukchi seas	36

	page
15. Cumulative (1982-90) distribution of 59 sightings of 82 bowhead whales seen on random transects west of Point Barrow (156°30'W)(A); best-fit lines depicting provisional 'northern' and 'southern' migration route(s) in the northeastern Chukchi Sea (B)	37
16. Summary of fall bowhead whale distribution in the Chukchi Sea from surveys conducted since the mid-1970s	39
17. Patterns of current flow in the Chukchi Sea	42
18. Cumulative (1982-90) distribution of 11 sightings of 13 bowhead whale calves	43
19. Cumulative (1982-90) distribution of 367 sightings of 3,497 belukhas	45
20. Cumulative (1982-90) belukha swimming direction in the western Beaufort and northeastern Chukchi seas	46

TABLES

	page
1. Data entry format on the flight computer	9
2. Summary of flight effort, 1990	13
3. Bowhead whale relative abundance (WPUE = no. whales/survey hour) by survey block, 1990	19
4. Belukha relative abundance (WPUE = no. whales/survey hour) by survey block, 1990	24
5. Summary of polar bear sightings, 1990	27
6. Summary of survey effort, general ice conditions and bowhead whale sightings (SI) and number (No.) in the study area, 1980-90	29
7. Cumulative (1982-90) bowhead whale relative abundance (WPUE = no. whales/survey hour) in the study area by survey block	33
8. Cumulative (1982-90) belukha relative abundance (WPUE = no. whales/survey hour) in the study area by survey block	47

ACRONYMS AND ABBREVIATIONS

BE	Belukha
BH	Bowhead Whale
BS	Bearded Seal
BWASP	Bowhead Whale Aerial Survey Project
CPUE	Calves Per Unit Effort
CT	Unidentified Cetacean
GNS	Global Navigation System
GW	Gray Whale
IDL	International Date Line
IWC	International Whaling Commission
MMS	Minerals Management Service
MLR	Multiple Linear Regression
NMFS	National Marine Fisheries Service
nmi	Nautical Mile
NOAA	National Oceanographic and Atmospheric Administration
NOSC	Naval Ocean Systems Center
NTIS	National Technical Information Service
OAS	Office of Aircraft Services
OCS	Outer Continental Shelf
POP	Platforms of Opportunity Program
PN	Unidentified Pinniped
PR	Polar Bear
RS	Ringed Seal
SAR	Search and Rescue
s.d.	Standard Deviation
SI	Sighting
SPUE	Sightings Per Unit Effort
USFWS	United States Fish and Wildlife Service
WPUE	Whales Per Unit Effort
WS	Walrus

EXECUTIVE SUMMARY

This field report summarizes the 1990 investigations of the distribution, abundance, migration timing and route, behavior, and habitat relationships of endangered whales in the Alaskan Chukchi and western Beaufort seas (hereafter, study area). Data presented herein were collected during transect and search surveys flown in specially modified aircraft, a Grumman Goose (model G21G) and a deHavilland Twin Otter (series 300), over the study area from 3 October through 7 November. The Bering Sea stock of bowhead whales (Balaena mysticetus), estimated by the International Whaling Commission (IWC) to number 7,500 whales, was the principal species studied. The California-Chukotka stock of gray whales (Eschrichtius robustus), estimated by the IWC to number over 21,000 whales, was also studied, with incidental sightings of all other marine mammals routinely recorded. Data on bowhead whales collected during the 1990 season were subsequently compared to and integrated with the results from this study in 1989, and from similar studies conducted by the Naval Ocean Systems Center (NOSC) and SAIC, Maritime Services Division (formerly, SEACO/SAIC) from 1980-88.

The 1990 field season was compromised by circumstances that affected the availability of the aircraft dedicated to aerial surveys in the study area. Extensive maintenance on the survey aircraft delayed its arrival in Alaska until mid-October. Three transect surveys were flown in the eastern portion of the study area on 3, 9 and 11 October using the aircraft responsible for surveys in the Beaufort Sea. Upon the arrival of the dedicated survey aircraft in Barrow on 14 October, the aircraft and survey crew were requested to support a Search and Rescue (SAR) effort until 22 October. This was followed by a three day (23-25 October) delay for minor aircraft maintenance. Consequently, a dedicated aircraft was not available for transect surveys in the study area until 26 October, five weeks after the intended start of the field season (20 September). Although data on endangered whales and all marine mammals were collected during SAR flights and transect surveys, survey effort and results were clearly not comparable to 1989. Therefore, data collected in 1990 were summarized and integrated with past years, as possible, and are presented in this Field Report in lieu of a full Annual Report.

There were 14 sightings of 19 bowhead whales in the study area from 9 October through 29 October 1990. The bowhead migration through the study area undoubtedly

began before the first bowhead was seen on 9 October and likely extended beyond 29 October. Eskimo whalers in Barrow successfully took whales on 1 and 3 October, indicating that the migration through the study area was underway then. Survey effort shifted from northern to southern Chukchi Sea waters on 4 November, but no bowheads were seen there.

Most bowhead whales were seen along a migration route that was nearshore east and west of Barrow. Seven bowheads, including two calves, were seen north of 72°N latitude in the Chukchi Sea, suggesting that some whales take a northerly route across the study area. Most bowheads were swimming, with direction of travel significantly clustered about 248°T ($p < 0.005$) in the northeastern Chukchi Sea. Survey effort and all bowhead sightings are depicted in daily flight maps and tabularized summaries and presented in Appendix A.

During an unrelated study, approximately 41 bowhead whales were seen in the southern Chukchi Sea from the NOAA research vessel Surveyor from 8 to 12 October 1990. Most of these whales (73%, $n=30$) were seen just west of the study area. However, one whale was seen in the Hope Basin OCS Planning Area (survey block 23), the first such sighting in fall to our knowledge. Ten bowheads were seen in survey block 14, near areas where whales have been seen in past years.

There was one sighting of one gray whale in the study area in 1990, nearshore southwest of Point Barrow. Survey effort in 1990 was deficient in areas where gray whales have been seen in past years. One large cetacean was seen too far from the aircraft to allow positive identification, and was therefore recorded as unidentified. The reader is directed to Clarke et al. (1989) and to Moore and Clarke (1990) for recent summaries of gray whale distribution and abundance in the study area.

There were 60 sightings of 110 belukhas (Delphinapterus leucas) in the study area in 1990. Distribution was north of that seen in past years, reflecting the effort of the SAR flights north of the study area.

INTRODUCTION

The Outer Continental Shelf (OCS) Lands Act (67 Stat. 462) established Federal jurisdiction over the submerged lands of the continental shelf seaward of state boundaries in 1953, and charged the Secretary of the Interior with responsibility for administering minerals exploration and development of the OCS. In keeping with the National Environmental Policy Act (1969), the Marine Mammal Protection Act (1972) and the Endangered Species Act (1973), the OCS Lands Act Amendments (1978) established a management policy that included studies in OCS lease sale areas to ascertain potential environmental impacts of oil and gas development on OCS marine coastal environments. The Minerals Management Service (MMS) is the agency responsible for these studies and for the leasing of submerged Federal lands.

The first OCS oil and gas lease sale entirely in the Chukchi Sea (Sale 109) was held in May 1988, with additional lease sales scheduled in 1991 and 1992. Lessees were advised in the Notice of Sale for Sale 109 that the MMS intends to continue an endangered whale monitoring program during exploration activities in the Chukchi Sea. In September 1989, the MMS awarded SAIC, Maritime Services Division (formerly, SEACO/SAIC) a 3-year contract to monitor the distribution of endangered whales, and secondarily all other marine mammals, in the Alaskan Chukchi and western Beaufort seas via aerial surveys. This report constitutes a summary of the results of the second year of field work under this contract.

The Alaskan Chukchi and western Beaufort seas from the Bering Strait to 73°N latitude between 154°W and 169°W longitude (hereafter, study area) seasonally support several marine mammal species. This region incorporates the Chukchi and Hope Basin OCS Planning Areas and a portion of the Beaufort Sea OCS Planning Area (Fig. 1). In fall, bowhead whales (*Balaena mysticetus*) and gray whales (*Eschrichtius robustus*), both listed as endangered species, co-occur at least in the northeastern portion of the study area, and belugas and several species of pinnipeds occur throughout the region (Moore et al. 1986a; Moore and Clarke 1990).

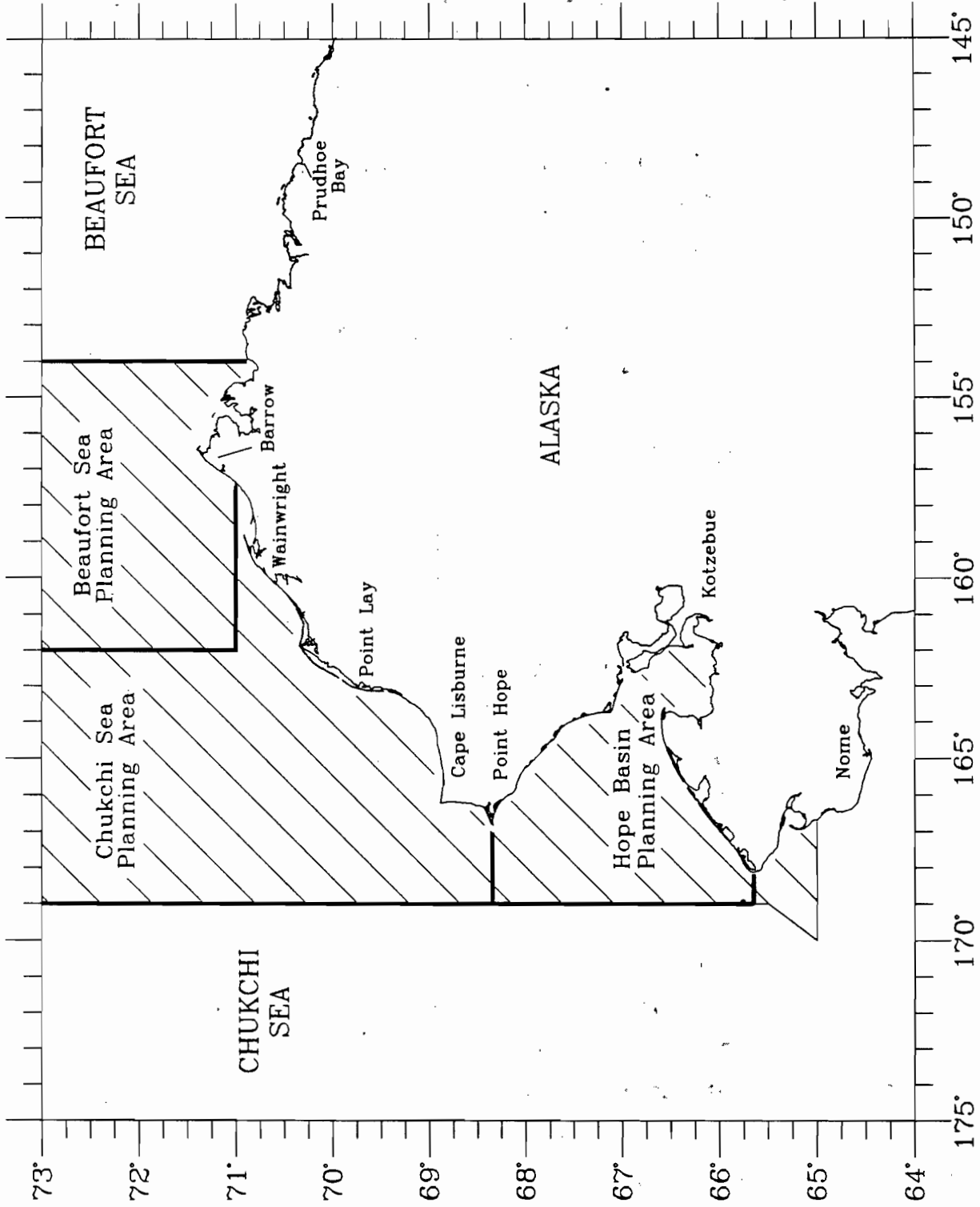

Figure 1. Study area depicting boundaries of the Chukchi and Hope Basin OCS Planning Areas, and the westernmost portion of the Beaufort Sea OCS Planning Area.

Bowhead whales are the species of principal interest due to their endangered status and because they are the focus of an annual subsistence hunt by Alaskan Eskimos. Historically, bowheads had a nearly circumpolar distribution north of 60°N latitude, but a long history of exploitation seriously reduced the number of whales in each of five geographically separate stocks (Breiwick et al. 1981; Bockstoce and Botkin 1983; Bockstoce 1986). The Bering Sea stock, estimated by the International Whaling Commission (IWC) to contain 7,500 whales (IWC 1991), is the population monitored in this study. This stock annually migrates around western and northern Alaska between wintering areas in the northern Bering Sea and summer feeding grounds in the Canadian Beaufort Sea. The spring migration generally occurs from early April through June along open-water lead systems that annually develop relatively near shore in the Chukchi Sea (Ljungblad et al. 1986c; Braham et al. 1984). The timing and route of the fall migration across the Chukchi Sea is less well-defined. It appears that most whales swim south-southwest after passing Point Barrow crossing the central Chukchi Sea near Herald Shoal, while a second component may take a more northerly course towards Herald and Wrangel islands before heading south along the Chukotkan coast (Moore and Clarke 1990; Braham et al. 1984). The migration likely occurs from late September through at least early November.

Gray whales are also classified as endangered, although recent estimates of their number indicate that the California-Chukotsk stock has completely recovered from the commercial harvest of the late nineteenth century (Breiwick et al. 1988). The Chukchi Sea represents the northernmost feeding ground for gray whales, although a few whales have been seen occasionally as far east as Herschel Island, Canada (Rugh and Fraker 1981; Wursig et al. 1983). Dense aggregations of feeding whales are common in the northern Bering Sea (Moore et al. 1986b), and were seen in the southern Chukchi Sea in fall 1989 (Moore and Clarke 1990). Gray whales routinely feed along the Chukchi coast and in some years in the north-central Alaskan Chukchi Sea (Clarke et al. 1989). Furthermore, there is evidence that cows with calves segregate from the main population and are found more often along the Chukchi coast than among whales feeding in the northern Bering Sea (Moore et al. 1986b), as has been reported for the Chukotsk coast (Bogoslovskaya 1986). These findings suggest that portions of the Chukchi Sea may be

important habitat for feeding and calf weaning for a population of gray whales that is near historical levels of abundance (Breiwick et al. 1988).

This field report is a summary of results for 1990 aerial surveys of endangered whale distribution, relative abundance, migration and behavior in the Alaskan Chukchi and western Beaufort seas, in accordance with the objectives outlined below. Belukha distribution and relative abundance are also reported, as well as incidental information on all other marine mammals seen. Flight tracks and descriptive captions, presented in Appendix A, provide an overview of daily survey effort and results.

Objectives

The primary objectives of the 1990 aerial survey study were to:

- determine seasonal distribution, migration timing and route, relative abundance, behavior and habitat characteristics of bowhead and gray whales (hereafter, endangered whales) in or near existing and proposed Federal lease sale areas in the study area;
- derive estimates of relative and/or absolute abundance of endangered whales to describe spatial and temporal distribution patterns;
- describe behavioral characteristics of endangered whales as observed in or near existing and proposed Federal lease sale areas, with special emphasis on locating potential feeding areas and migration pathways;
- record locations and numbers of other marine mammals incidental to sightings of endangered whales;
- consult and coordinate field activities with other Federal agencies, state or local government organizations, or other endangered species researchers to maximize productivity of this study and minimize conflict with other resource users; and
- synthesize and further analyze endangered whale data obtained on surveys conducted in the study area since 1980 to describe temporal variation in fall sighting rates and to determine if any shift in the migration routes has been induced by human activities.

METHODS AND MATERIALS

Project Rationale and Design

The timing and route of the fall bowhead migration across the Chukchi Sea is ill-defined compared to the spring migration (Moore and Clarke 1990; Ljungblad et al. 1986c; Braham et al. 1984). Further, bowhead whales feed in the western Beaufort Sea in fall of some years, but not in others (Ljungblad et al. 1986a). Coastal and offshore areas in the northern Chukchi Sea are important feeding habitat for gray whales (Clarke et al. 1989), but movements to and from these areas are poorly understood. Therefore, the primary objective of this project was to determine distribution and relative abundance, define fall migration timing and route, and identify feeding areas for bowhead and gray whales in the study area. Related objectives included describing whale behaviors and recording their proximity, and reaction if any, to ongoing offshore industrial operations.

The 1990 field season was adversely affected by two unfortunate circumstances that undermined the planned study objectives. First, extensive maintenance on the dedicated survey aircraft (N780) delayed its arrival in Alaska until mid-October, and there was no replacement aircraft available. As a result, there were no flights in the study area in late September and only three short transect surveys through mid-October, completed by the survey crew aboard the aircraft responsible for the MMS Bowhead Whale Aerial Survey Project (BWASP) in the Beaufort Sea (Treacy 1991). Second, when N780 arrived in Barrow in mid-October, the aircraft and survey crew were requested to support a Search and Rescue (SAR) effort coordinated by Barrow Search and Rescue and the U.S. Coast Guard through 22 October. The flights in support of the SAR effort were usually north of the study area. Minor aircraft maintenance further delayed surveys on 23-25 October, therefore dedicated transect surveys in the study area did not begin until 26 October, when two-thirds of the scheduled 1990 field season had passed.

Although the circumstances contributing to the poor sampling achieved during the 1990 field season were beyond the control of MMS, OAS or SAIC, they undeniably affected data collection and subsequent analyses. While data on all marine mammals were collected wherever possible, the 1990 data base is not analogous to 1989, and comparisons between years will be minimal. Nevertheless, useful data on several

marine mammal species were obtained and are presented as appropriate in this Field Report.

Study Area and Aerial Survey Procedure

The study area included the western Beaufort Sea from 157°W east to 154°W offshore to 73°N, and the Alaskan Chukchi Sea from 157°W west to the International Date Line (IDL, approximately 168°58'W) between 65°40'N and 73°N. This area was divided into survey blocks (Fig. 2), such that one or, with favorable conditions, two blocks could be surveyed completely on one flight. Survey blocks 12 through 22 are identical to those surveyed since 1983 (Moore and Clarke 1990; Ljungblad et al. 1988), facilitating comparisons of data among years.

Two types of aerial surveys were conducted:

1. Line transect surveys were flown in survey blocks to determine distribution and estimate relative and absolute abundance. Line transect is one available survey method from which statistical inferences can be made, provided the starting and turning points of the line are selected randomly (Cochran 1963). Survey blocks were divided into sections that were 30 minutes of longitude or 10 minutes of latitude wide, and each section was divided into 10 equal segments. Random transect lines were derived for each section by matching two numbers from a random numbers generator to the numbered segments and drawing a line between them. The same procedure was followed for each section of the survey block and all transect lines were then linked together with connecting lines at the top and bottom.

2. Search surveys were flown to locate whales and observe their behavior or when in transit to a transect block or a new base of operations. These surveys did not follow a preset paradigm, but instead were dependent upon weather, sea state and ice conditions, or previous patterns of whale sightings. All flights in 1990 in support of the SAR effort were search surveys.

Two specially modified aircraft were used for the surveys in 1990; a Grumman Turbo Goose (model G21G) with a call sign of N780, and a deHavilland Twin Otter (series 300) with a call sign of 301EH. Both were equipped with a Global Navigation System

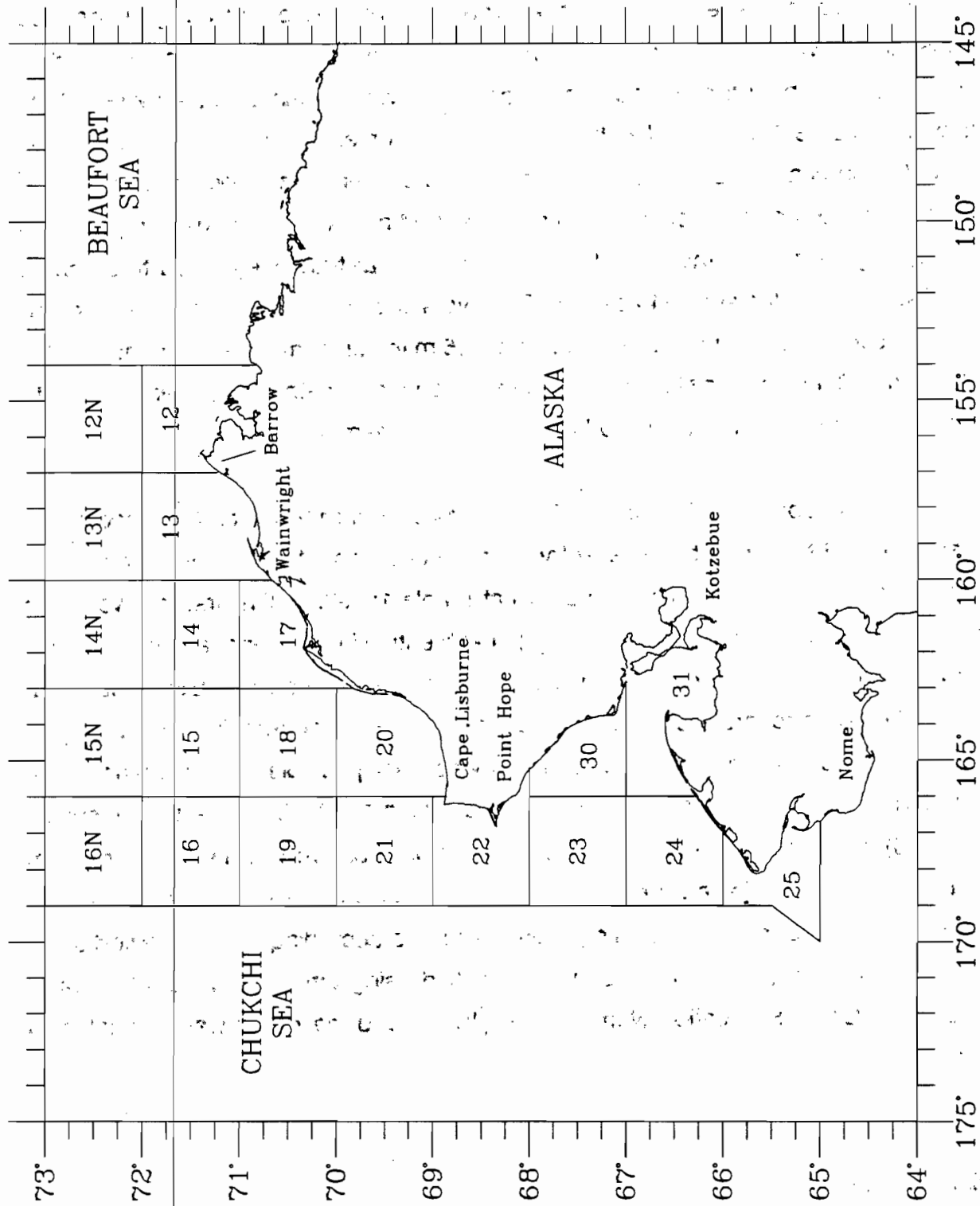

Figure 2: Survey blocks derived for the study area.

(GNS) 500 that provided continuous position updating (rated precision, 0.6 km/flight hr, ideally) and transect turning point programming. The cockpit in the Grumman Goose was outfitted with four seats, each of which afforded excellent visibility through large side windows for the two principal observers. A long rectangular window behind the cockpit provided good visibility for the recorder/observer. On the Twin Otter, a large bubble window with excellent downward visibility was provided on each side of the aircraft for the observer/recorder and one principal observer, while the other principal observer/navigator was seated forward in the cockpit. Each observer had a clinometer to take angles on all whale sightings abeam of the aircraft which, along with altitude, were used to compute animal distance from the survey track line. Observers and pilots were linked to a common communication system. Surveys were flown at 305 m to 458 m altitude, at speeds of 222 to 296 km/hr. The higher altitudes were maintained when weather permitted in order to maximize visibility and minimize disturbance to marine mammals.

A portable computer (Compaq LTE) was used aboard the aircraft to record and later analyze flight data. The data entry format consisted of 23 variables that were presented to the data recorder in menu format (Table 1: A-W). The first four variables (Table 1: A-D) were recorded automatically at each entry via an interface (AACO Model: Arinc 429 to RS 532) that connected the computer to the aircraft's GNS and radar altimeter. The data recorder could then select responses to the remaining variables, as required. Data for all variables were recorded whenever possible, and all entries were coded as to the type of survey being conducted (Table 1: E). During a typical survey flight (Fig. 3), a search leg was flown to the survey block, followed by a series of random transect legs that were joined together by connect legs, with search leg(s) conducted back to the base of operations. Sea state was recorded according to the Beaufort scale outlined in Chapman (1971). Ice type was identified using terminology from the Naval Hydrographic Office Publication Number 609 (1956), and ice cover was estimated in percent.

Data Analysis

Distribution and Abundance

Bowhead whale distribution was plotted for tri-monthly periods in relation to OCS oil and gas lease areas for the 1990 season on maps generated by AutoCAD using a map

Table 1. Data entry format on the flight computer.

A. GMT	H. HABITAT	O. SWIM SPEED (KTS)	U. ICE COVERAGE (%) & TYPE
B. LATITUDE	0. OPEN WATER	0. UNKNOWN	0. NO ICE
C. LONGITUDE	1. TIDE RTP	1. STILL 0 KTS	1. FLOE
D. ALTITUDE	2. ON ICE	2. SLOW <1 KT	2. BROKEN FLOE
	3. ON LAND	3. MEDIUM 1-3 KTS	3. PACK
		4. FAST >3 KTS	4. PACK/FLOE
E. REASON FOR ENTRY	I. BEHAVIOR	P. AIRCRAFT RESPONSE	5. GREASE/NEW
0. FLIGHT ABORTED	0. UNKNOWN	1. YES	6. SHOREFAST
1. SIGHT ON TRANSECT	1. DIVE	2. NO	7. LEAD
2. SIGHT OFF TRANSECT	2. REST	3. UNKNOWN	8. BKN FLOE & NEW
3. SIGHT SEARCH SURVEY	3. SWIM		9. NEW & BKN FLOE
4. POSITION-ON TRANSECT	4. MATE		
5. POSITION-ON CONNECT	5. FEED		V. BEAUFORT SEA STATE
6. POSITION-ON SEARCH	6. MILL		0. BO GLASSY <1 KNOT
7. START TRANSECT	7. SPY HOP		1. B1 LT RPL 1-3 KTS
8. END TRANSECT	8. BREACH		2. B2 SHL WAVES 4-6 KNTS
9. DIVERT TRANSECT	9. ROLL		3. B3 SCTR CAPS 7-10 KTS
10. RESUME TRANSECT	10. SLAP		4. B4 NUM CAPS 11-16 KTS
11. DEADHEAD	11. U/W BLOW		5. B5 MANY CAPS 17-21 KTS
	12. COM/CALF		6. B6 ALL CAPS 22-27 KTS
F. SPECIES	13. DEAD	R. OBSERVER	7. B7 BRKNG WAVES 28-33 KTS
0. NO SIGHTING	14. RUN	S. WEATHER	8. B8 FOAM 34-40 KTS
1. BOWHEAD	15. THRASH	1. CLEAR	9. NA NOT APPLICABLE
2. GRAY WHALE		2. PARTLY CLOUDY	
3. BELUGA	J. SIZE	3. FOG	
4. WALRUS	0. UNKNOWN	4. OVERCAST	0. WATER COLOR
5. BEARDED SEAL	1. CALF OF YEAR	5. PRECIPITATION	1. LIGHT BLUE
6. RINGED SEAL	2. IMMATURE	6. LOW CEILING	2. DARK BLUE
7. POLAR BEAR	3. ADULT	7. HAZE	3. LIGHT GREEN
8. UKN CET	4. LARGE ADULT	8. GLARE	4. DARK GREEN
9. UKN PIN	5. COM/CALF PAIR		5. BLACK
10. ORCA		T. VISIBILITY (L/R)	6. MUDDY
11. MINKE	K. TOTAL NUMBER	0. 0 KM	7. TIDELINE
12. FIN	L. CALF NUMBER	1. <1 KM	
13. VESSEL	M. CLINOMETER ANGLE	2. 1-2 KM	
	N. SWIM DIRECTION (MAG.)	3. 2-3 KM	
G. SIGHTING CUE		4. 3-5 KM	
0. NO CUE		5. 5-10 KM	
1. SPLASH		6. UNLIMITED	
2. BLOW			
3. BODY			
4. ICE TRACKS			
5. MUD PLUMES			
6. BIRDS OR FISH			
7. KILL SIGHT			
8. OIL SIGHT			

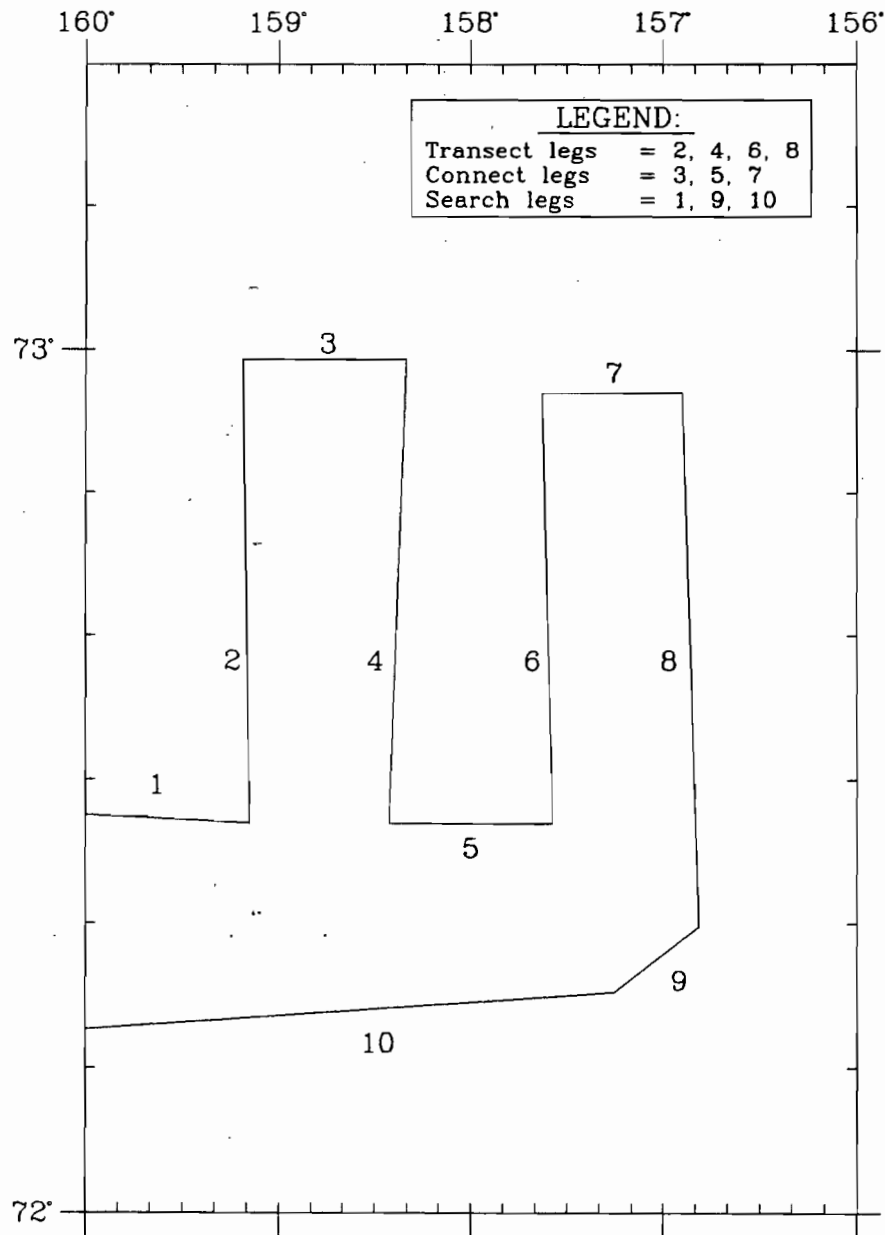

Figure 3. Example of an aerial survey flight track depicting transect, connect and search survey legs.

digitized by the United States Geological Survey (Bauer 1989). Tri-monthly and seasonal relative abundance indices were calculated as whales per unit effort (WPUE = no. whales/survey hour) by survey block for bowhead whales and belukhas. Distribution and WPUE are presented in semi-monthly periods for 1982-90 bowhead whale and belukha data. Insufficient data were gathered in 1990 to warrant the calculation of density estimates for bowhead and gray whales. The reader is referred to Moore and Clarke (1990), Appendix B, for survey block density estimates for years 1982 to 1989.

Migration Route

Migration route across the Alaskan Chukchi Sea was defined by fitting lines to all random bowhead sightings east of Point Barrow (ca. 156° 30'W longitude) by the method of least squares (Zar 1984). Description of migration route was further accomplished by analyzing swimming direction using descriptive statistics for circular distributions, where \bar{a} represents the mean vector direction and \bar{r} is the mean vector length (Batschelet 1981). Because whales that are milling, feeding or resting often change direction several times while at the surface, swimming direction for whales exhibiting those behaviors was omitted from the analyses. Insufficient data were collected to analyze annual migration route (or timing) for 1990. However, 1990 data were integrated with 1982-89 data for line fitting. The reader is directed to Moore and Clarke (1990) for comparisons of annual migration route and timing for years 1982 to 1989.

Calf Sightings

Calf sightings were plotted for 1982-90. To determine if there was any pattern of temporal segregation, semi-monthly calf ratios (no. calves/total number of whales) for 1982-90 data were compared using Chi-square analysis for proportions (Zar 1984).

RESULTS

Survey Effort and Conditions

A total of 85.97 hours of surveys were flown in 1990, with 61.89 hours (72%) of this effort in the Chukchi Sea (i.e., waters west of 157°W) and 24.08 hours (28%) in the western Beaufort Sea (Table 2). Line transect surveys were flown whenever possible, with time spent on random lines accounting for 28% (24.28 hours) of the total survey time. Surveys were based out of Deadhorse (3-13 October), Barrow (14 October - 4 November) and Kotzebue (5-7 November) Alaska. Survey effort is depicted in 10 or 11-day increments in Figure 4, and ice conditions encountered during the survey season are represented in Figure 5. Daily survey effort and marine mammal sightings are summarized in Table A-1, Table A-2, and in daily flight maps presented in Appendix A.

No surveys were conducted in the Chukchi Sea study area in September, and only four transect lines were completed in block 12 from 3-10 October 1990 (Fig. 4). Surveys from 11-20 October were mostly searches through the study area during SAR flights, with one transect survey in portions of blocks 12 and 13. Searches associated with SAR flights were conducted on 21-22 October. Transect surveys, mostly in the northern survey blocks, were conducted from 26-31 October. Transect surveys continued in the northern survey blocks on 1-2 November, with transect lines flown enroute to Kotzebue on 4 November. The season ended with transect surveys flown in outer Kotzebue Sound from 5-7 November.

Ice conditions in 1990 were exceptionally light (Fig. 5). The ice edge was even further offshore than in 1989, a year when ice conditions were also extremely light (Moore and Clarke 1990). Fall ice cover averaged over 29 years (1953-81) indicate that ice is usually more extensive in the Chukchi Sea study area than conditions encountered in 1990 (La Belle et al. 1983; see Fig. 11). There is some evidence that ice conditions in the Arctic are cyclic, with a 4-6 year cycle in the western Arctic (i.e., Beaufort and Chukchi seas) (Mysak and Manak 1989). It would appear from ice conditions in 1986-87 and 1989-90 that the western Arctic is in a period of relatively light ice cover.

Exploratory drilling was conducted at three sites in the Chukchi Sea Planning Area in 1990, but operations were completed by 11 October before any transect surveys were

Table 2. Summary of flight effort, 1990.

	1-10	October 11-20	21-31	November 1-7	Total
Number of flights [SAR flights]	2	11 [10]	7 [2]	6	26 [12]
Unacceptable weather (days)	5	1	2	1	9
Aircraft maintenance (days)	0	0	2	0	2
BWASP effort (days) ^a	3	0	0	0	3
Flight Effort Summary					
Chukchi Sea					
Transect (km)	0	218	2708	1948	4874
Connect (km)	0	45	284	160	489
Search (km)	0	6263	2223	1614	10100
Transect (h)	0	0.83	10.53	7.82	19.18
Flight (h)	0	24.81	22.08	15.00	61.89
W. Beaufort Sea					
Transect (km)	336	168	0	751	1255
Connect (km)	42	41	0	92	175
Search (km)	131	4307	97	121	4656
Transect (h)	1.38	0.66	0	3.06	5.10
Flight (h)	1.97	17.81	0.41	3.89	24.08
Total					
Transect (km)	336	386	2708	2699	6129
Connect (km)	42	86	284	252	664
Search (km)	131	10570	2320	1735	14756
Transect (h)	1.38	1.49	10.53	10.88	24.28
Flight (h)	1.97	42.62	22.49	18.89	85.97

^a BWASP effort (see Treacy 1991)

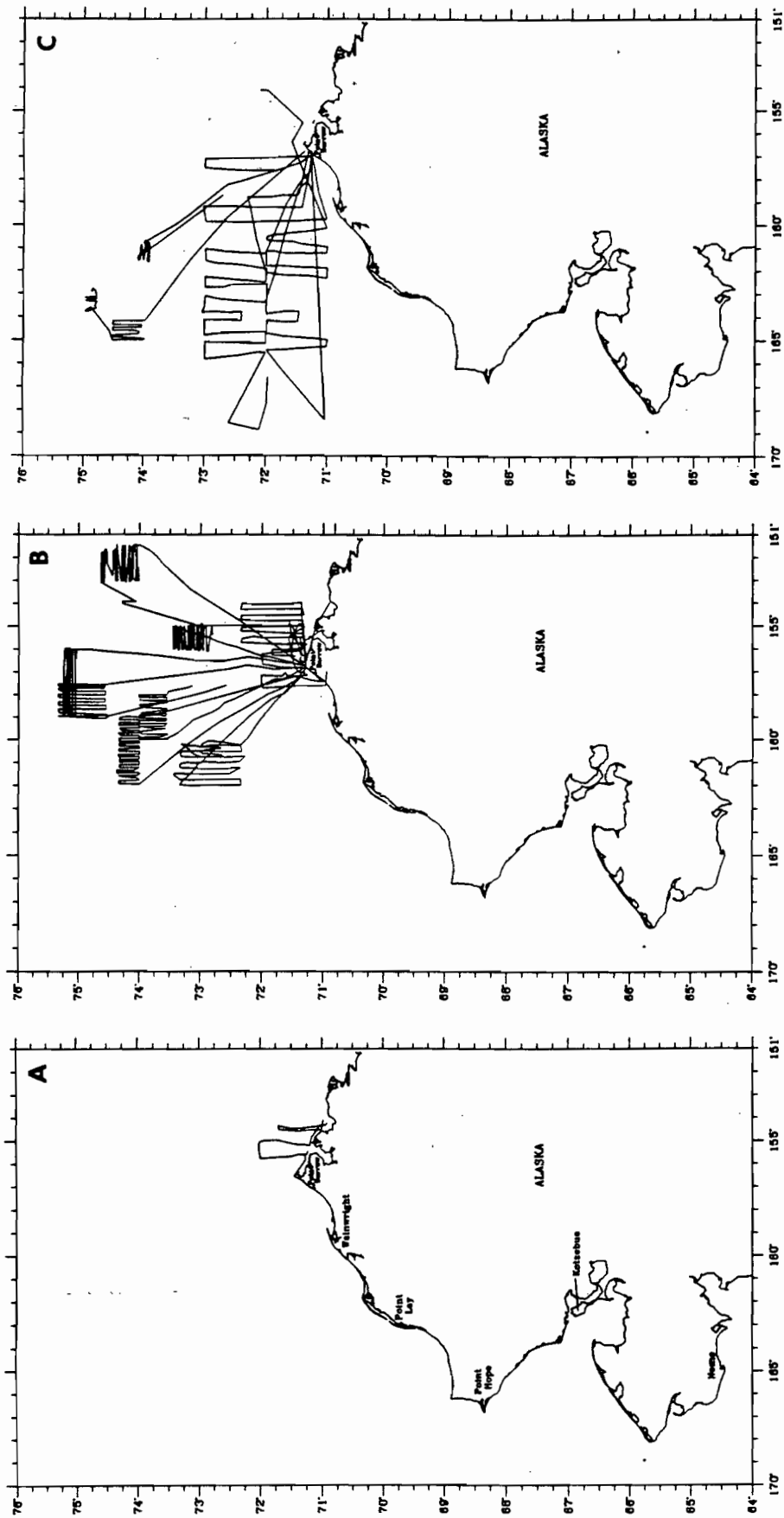

Figure 4. Composite flight tracks depicting 1990 flight effort: 2 surveys, 3-10 October (A); 11 surveys, 11-20 October (B), 7 surveys, 21-31 October (C);

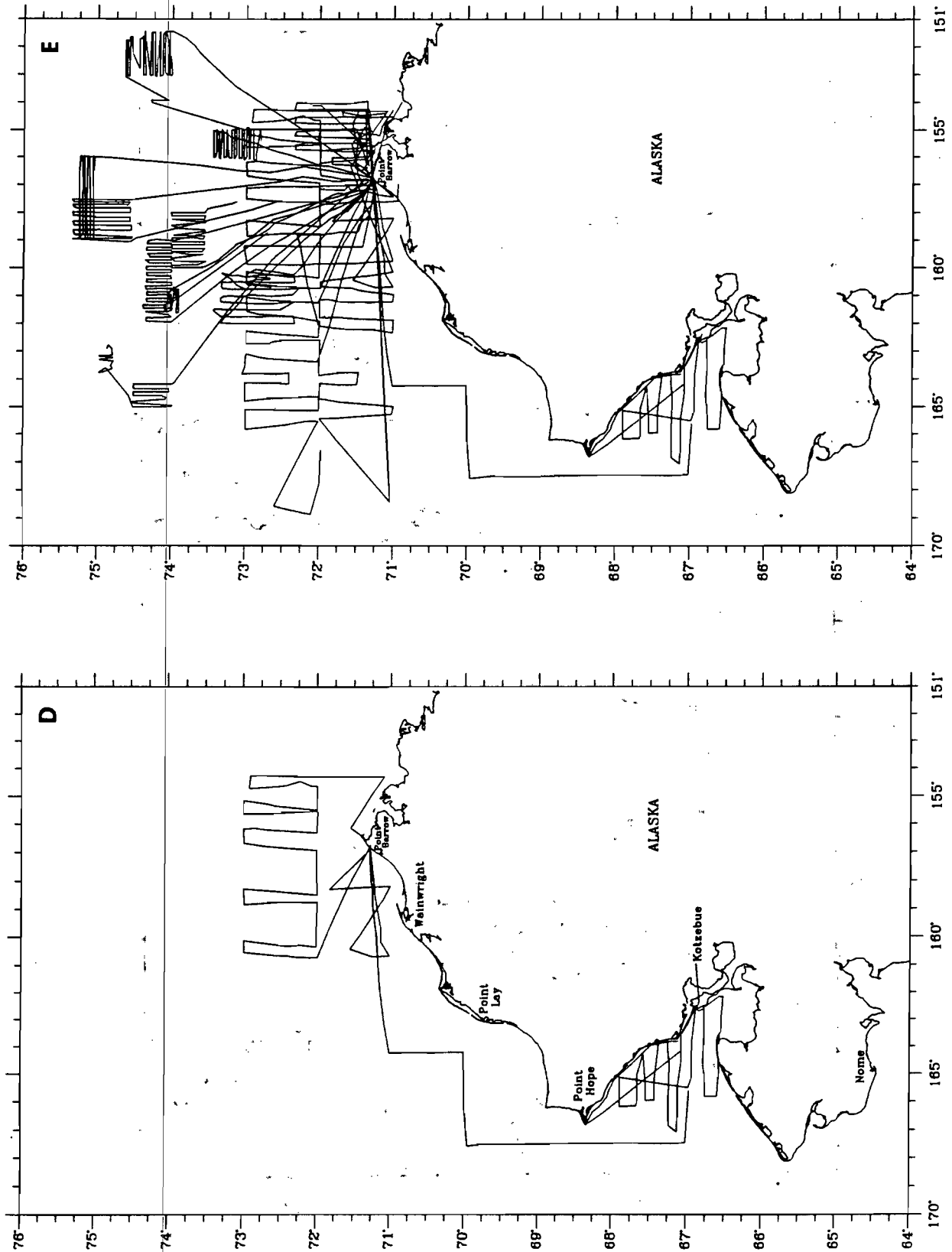

Figure 4 (cont). 6 surveys, 1-7 November (D); and 26 surveys, 3 October - 7 November (E).

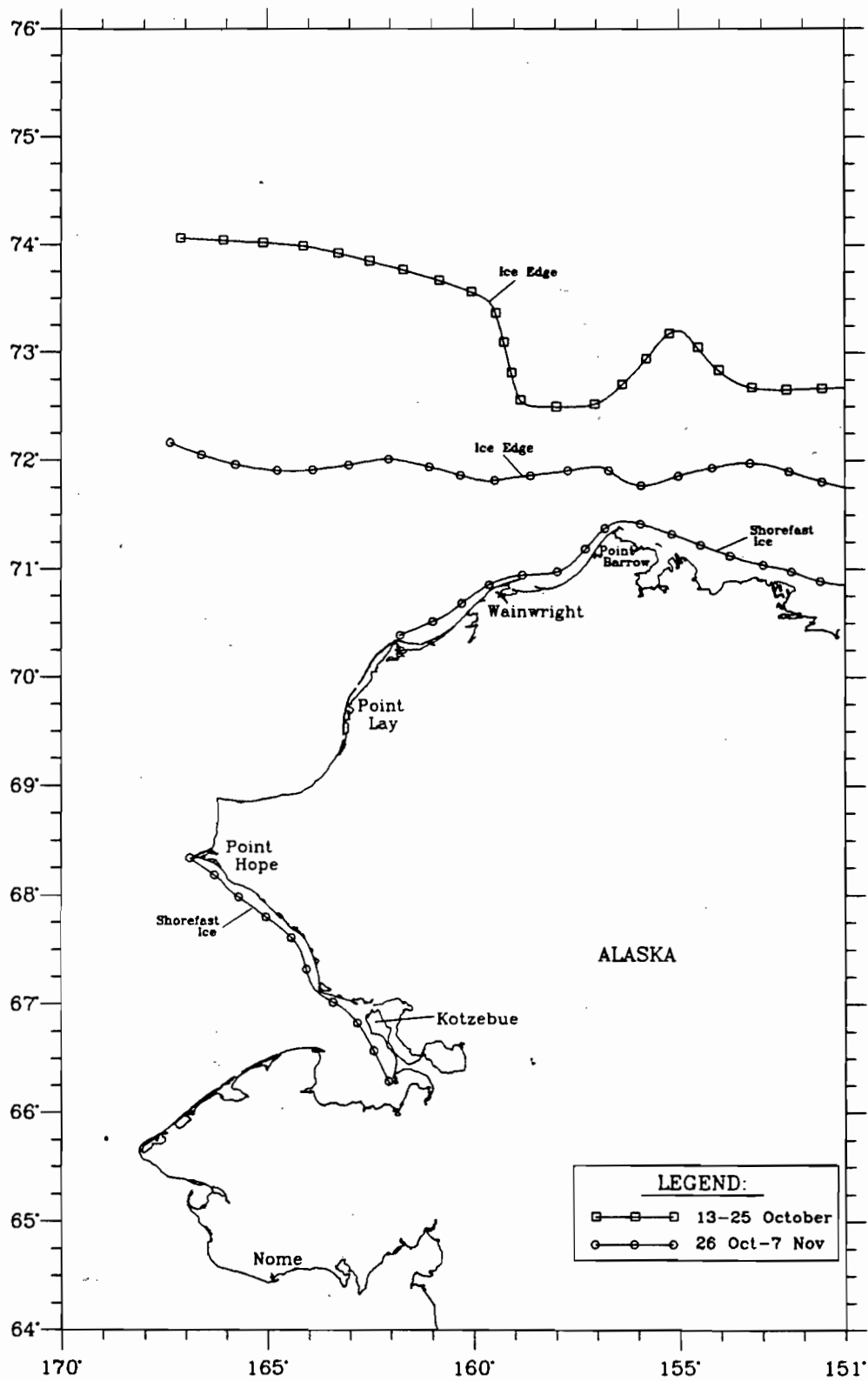

Figure 5. Approximate location of the ice edge ($\geq 90\%$ ice cover) during the 1990 season.

conducted near the sites. The drillship Canmar Explorer III and attendant supply vessels and helicopters worked at 'Burger' site (ca. 71°15'N, 163°12'W), 'Popcorn' site (ca. 71°51'N, 165°48'W) and 'Crackerjack' site (71°25'N, 165°32'W) from late July through 11 October. Surveys for walrus were conducted in association with this exploratory drilling, as in 1989 (Brueggeman et al. 1990).

Bowhead Whale (Balaena mysticetus)

Distribution and Abundance

There were 14 sightings of 19 bowhead whales in, and just north of, the study area in 1990 (Fig. 6; Table A-2). As in past years, some sightings overlapped the boundaries of OCS oil and gas lease areas, particularly those in the western Beaufort Sea. The first two whales seen were in block 12 on 9 October (Appendix A: Flight 2). Eskimo whalers at Barrow landed bowheads on 1 and 3 October, so whales were in the area before this first-sighting date. Bowheads were seen near Barrow in blocks 12 and 13 on 11 October (Appendix A: Flight 3) and 14 October (Appendix A: Flight 5). Perhaps the most interesting sighting was that of five bowheads, including 2 calves, seen just north of block 14N, during a search survey while returning from an SAR flight on 14 October (Appendix A: Flight 6). These whales appeared to be milling or resting when first seen. Because most SAR flights were conducted at relatively low altitudes (300-500'), it was not surprising that the whales responded to the overflight. One whale slapped its flukes, and the calves swam rapidly toward the large adults. Four bowheads were seen in block 13 near Barrow between 15 and 21 October (Appendix A: Flights 7, 8 and 14), and biologists on another aircraft returning from a SAR flight reported six bowheads about 40 nmi (75 km) east of Point Barrow on 18 October. The last two whales seen were in block 15N on 29 October.

Bowheads were seen in only three survey blocks; 12, 13 and 15N. Estimates of relative abundance were similar (WPUE = 0.60 - 0.75) in all three blocks (Table 3). These low indices are likely the result of the timing of the surveys. Typically, the first pulse of bowheads passes Point Barrow in early October, with a peak sighting-rate day from 4 to 6 October (Moore and Clarke 1990). This pulse, if present in 1990 (and successful hunting by Barrow whalers during this period suggests that it was), was missed due to aforementioned problems related to aircraft availability. A second pulse usually passes Point Barrow about 10 days later, with a peak sighting-rate day between 14 and 17

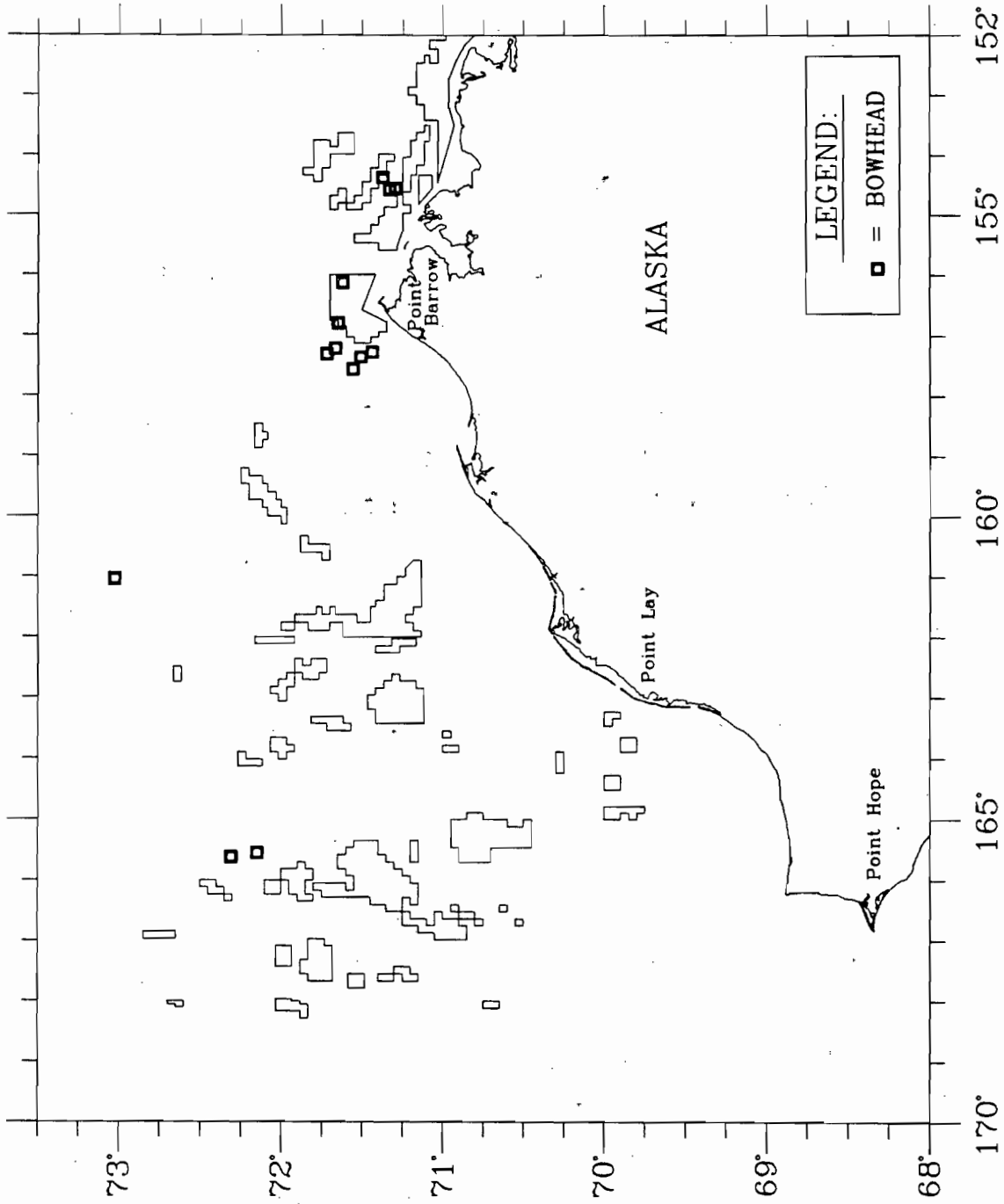

Figure 6. Distribution of 14 sightings of 19 bowhead whales relative to OCS lease areas, 1990.

Table 3. Bowhead whale relative abundance (WPUE = no. whales/survey hour) by survey block, 1990.

Block	1-10 Oct		11-20 Oct		21-31 Oct		1-7 Nov		TOTAL		
	HRS	WPUE	HRS	WPUE	HRS	WPUE	HRS	WPUE	BH	WPUE	
12	1.89	2	7.13	5	0.36	0	1.07	0	10.45	7	0.70
12N	0.07	0	3.92	0	0.06	0	2.81	0	6.86	0	0
13	0.00	-	2.41	3	3.52	2	2.34	0	8.27	5	0.60
13N	0.00	-	1.52	0	2.70	0	1.16	0	5.38	0	0
14	0.00	-	0.00	-	3.13	0	0.64	0	3.77	0	0
14N	0.00	-	3.39	0	2.30	0	1.00	0	6.69	0	0
15	0.00	-	0.00	-	1.75	0	0.19	0	1.94	0	0
15N	0.00	-	0.00	-	2.65	2	0.00	0	2.65	2	0.75
16	0.00	-	0.00	-	0.15	0	0.00	0	0.15	0	0
16N	0.00	-	0.00	-	0.20	0	0.00	0	0.20	0	0
18	0.00	-	0.00	-	0.02	0	0.56	0	0.58	0	0
20	0.00	-	0.00	-	0.00	0	0.15	0	0.15	0	0
21	0.00	-	0.00	-	0.00	0	0.70	0	0.70	0	0
22	0.00	-	0.00	-	0.00	0	0.80	0	0.80	0	0
23	0.00	-	0.00	-	0.00	0	1.12	0	1.12	0	0
24	0.00	-	0.00	-	0.00	0	0.13	0	0.13	0	0
30	0.00	-	0.00	-	0.00	0	3.87	0	3.87	0	0
31	0.00	-	0.00	-	0.00	0	2.31	0	2.31	0	0
UNB	0.00	-	24.25	5	5.63	0	0.07	0	29.95	5	0.17
Total	1.96	2	42.62	13	22.47	4	18.92	0	85.97	19	0.22

October, when the SAR effort was being carried out. By the time dedicated surveys were conducted in the study area in late October, the bulk of the bowhead migration usually monitored during this study had likely passed Point Barrow. Also, aircraft mechanical problems curtailed flights between 23-25 October, such that survey effort for 21-31 October 1990 (22.47 hours) was only about half that for the same period in 1989 (43.98 hours).

In addition to bowheads seen on aerial surveys, biologists aboard the NOAA research vessel Surveyor reported roughly 30 bowheads just west of the study area (ca. 67°13'-67°27'N between 169°35'-170°20'W) and one bowhead in the Hope Basin OCS Planning Area on 8 October 1990; also, a group of about 10 bowheads was seen in survey block 14 on 12 October 1990 (Fig. 7). The bowhead sighting in the Hope Basin Planning Area is the first such record in fall to our knowledge. These sightings are part of the NOAA/NMFS Platforms of Opportunity Program (POP) marine mammal sighting database (Boucher and Boaz 1989). No specific behaviors were recorded in association with these sightings, but the occurrence of bowheads in the southern Chukchi Sea during the same period as whales were seen near Point Barrow indicates that bowhead distribution can be quite widespread throughout the study area in October.

Inadequate data were collected in 1990 to assess migration timing and route. Whaling activities in early October and sightings of small groups of bowheads in mid- and late October near Barrow suggest the timing of the 1990 migration was similar to past years (Moore and Clarke 1990). Swimming direction for bowheads seen in the Chukchi Sea (west of 157°; n=7) was clustered around 248°T ($z=4.79$, $r=0.83$; $p<0.005$). Swimming direction for bowheads seen in the Beaufort Sea (154-157°) was clustered around 271°T, but not significantly so, possibly due to small sample size ($n = 4$). The reader is directed to the 'Bowhead Whale Migration Route' section in the Discussion and Review portion of this report for a summary of bowhead migration route using data collected from 1982-90.

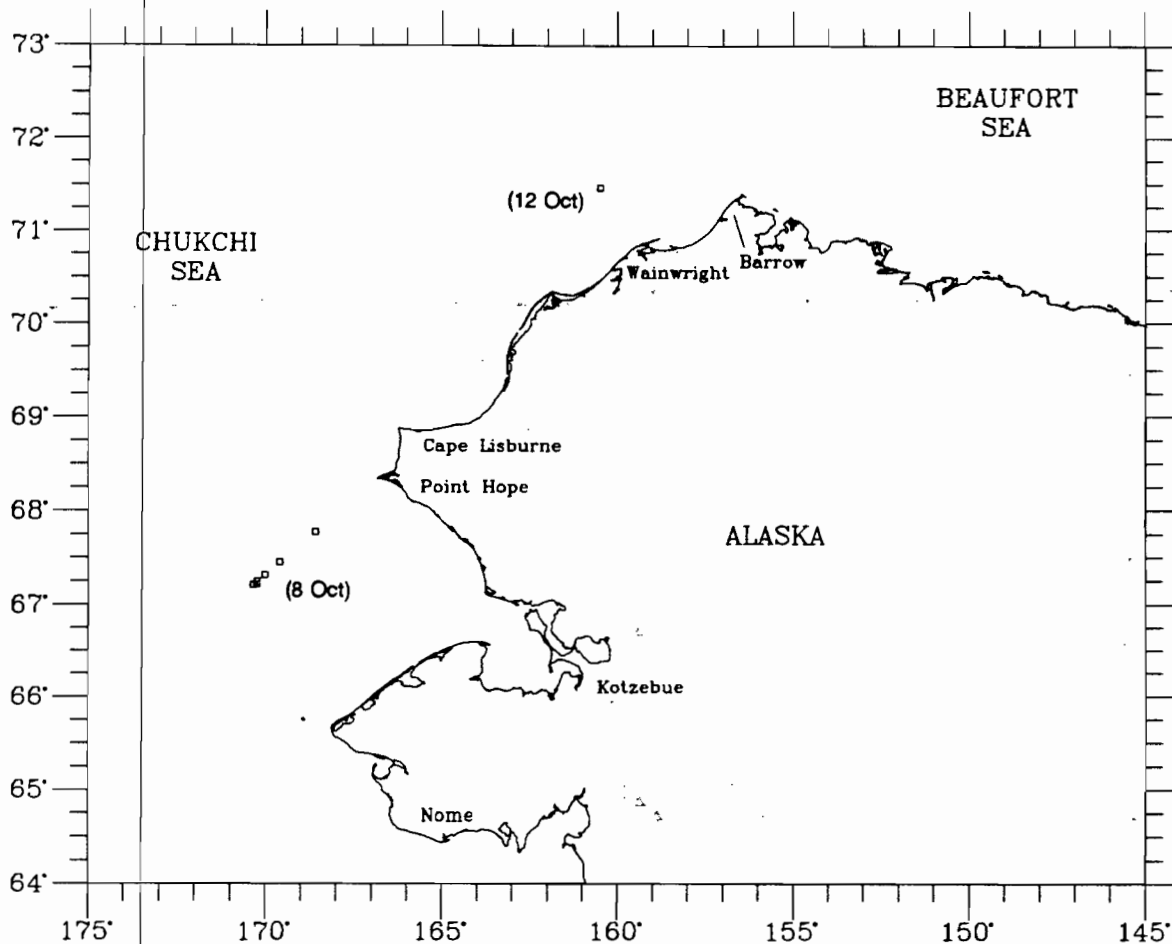

Figure 7. Distribution of 7 sightings of 41 bowhead whales from the NOAA research vessel Surveyor, October 1990.

Other Marine Mammals

Gray Whale (Eschrichtius robustus)

One gray whale was seen nearshore south of Barrow on 11 October (Appendix A: Flight 3). This was the only gray whale sighting for the 1990 season. Gray whales are commonly seen along the shore through mid-October, particularly near Point Franklin (Moore and Clarke 1990). A comprehensive review of gray whale occurrence in the northern Chukchi Sea is provided in Clarke et al. (1989).

Belukha (Delphinapterus leucas)

There were 60 sightings of 110 belukhas in 1990 (Fig. 8; Table A-2). Belukha sightings extended farther north than in past years, due to the survey effort conducted during SAR flights. Belukhas were seen as far north as 74°06'N at 161°47'W on 15

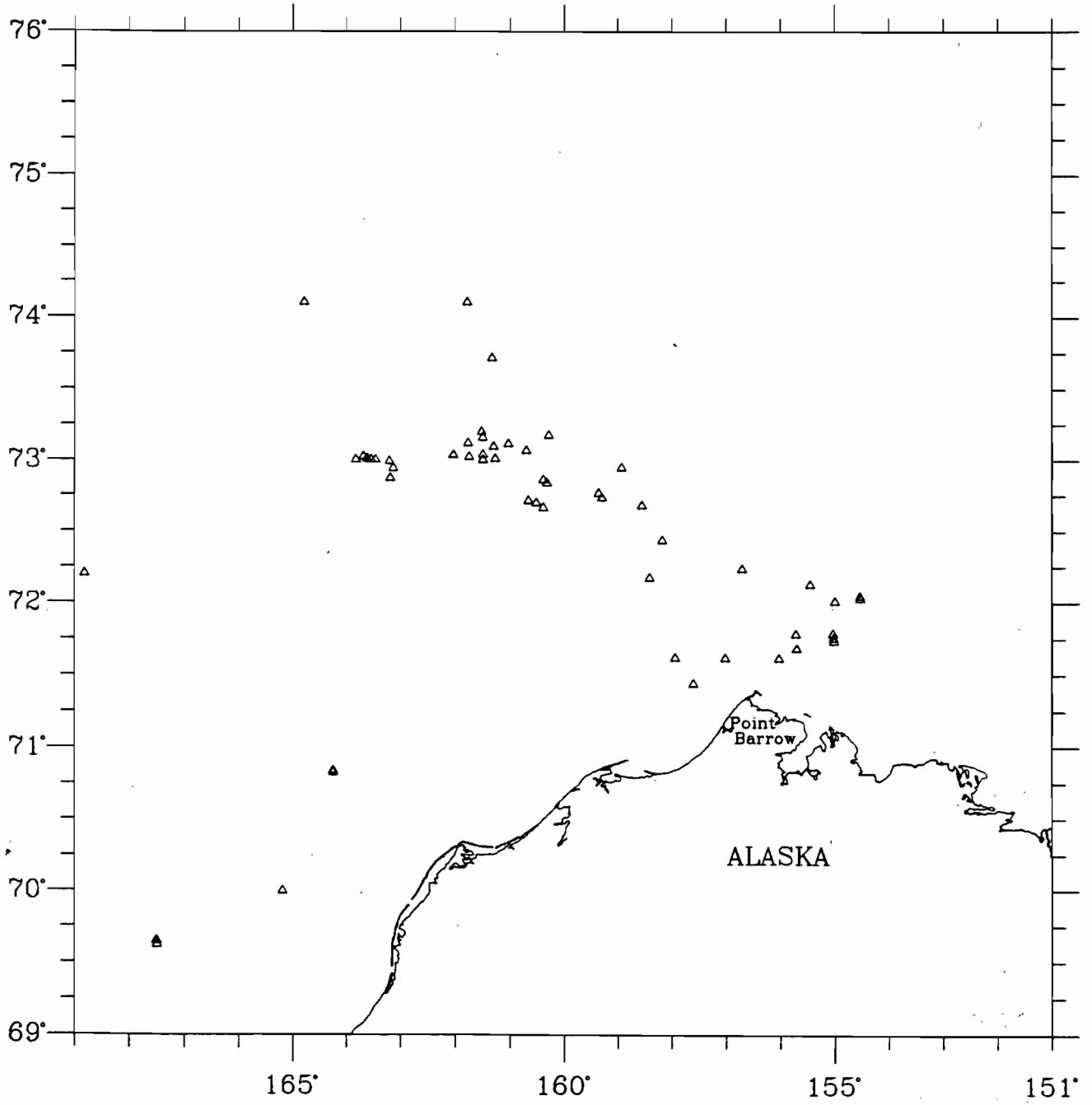

Figure 8. Distribution of 60 sightings of 110 belukhas, 1990.

October (Appendix A: Flight 7), with 37% (n = 22 sightings/41 whales) of all sightings north of 73° N between about 160° 40' W and 163° 50' W. As in past years, belukha distribution appeared bifurcated west of Point Barrow. The bulk of the sightings suggest a provisional 'northern' migration route near 73° N latitude, with scattered sightings along a provisional 'southern' route roughly parallel to the northeastern Alaskan coast.

Belukha abundance in the study area was highest in survey blocks 16N and 21 (Table 4). Belukhas were seen for the first time in blocks 20 and 21, indicating that some belukhas maintain a south-southwest course through the Chukchi Sea study area. Swimming direction for belukhas seen in the Chukchi Sea (west of 157° W) was clustered about 243° T, while swimming direction for belukhas seen between 154° W and 157° W was clustered about 203° T; neither heading was statistically significant. Overall, mean swimming direction in the study area was 232° T (r=0.24, z=3.23, p<0.05). The reader is directed to the 'Belukha' section in the Discussion and Review portion of this report for a summary of belukha migration route using data collected from 1982-90.

Walrus (Odobenus rosmarus)

There were 178 sightings of 1,319 walrus during 1990 surveys (Fig. 9). Most walrus were seen in waters north of 14N and, later in the season, in block 14N. Over 1,000 walrus were seen in this area on 14 October (Appendix A: Flight 6). Many were seen in water swimming singly or in small (<4 animals) groups, or resting on small pieces of ice. Walrus were seen south of 72° N only after 30 October (Appendix A: Flights 19 and 20). Walrus feeding traces have been reported for areas corresponding roughly to Hanna Shoal in the northeastern Chukchi Sea (Feder et al. 1990). This area was largely ice-free for much of the 1990 season, such that if walrus were feeding there they would have had a much longer swim from the ice edge to this foraging area than in most years.

Polar Bear (Ursus maritimus)

There were 41 sightings of 53 polar bears during 1990 surveys (Fig. 10; Table 5). Most bears were seen during SAR flights that were often conducted over ice north of the study area. Twenty three bears were seen on two SAR flights on 16 October (Appendix A: Flights 8 and 9). Polar bears were usually seen alone, sometimes with one or two cubs.

Table 4. Belukha relative abundance (WPUE = no. whales/survey hour) by survey block, 1990.

Block	1-10 Oct		11-20 Oct		21-31 Oct		1-7 Nov		TOTAL		
	HRS	WPUE	HRS	WPUE	HRS	WPUE	HRS	WPUE	HRS	WPUE	
12	1.89	4	2.12	0.84	0.36	0	1.07	0	10.45	10	0.96
12N	0.07	0	-	2.30	0.06	0	2.81	0	6.86	9	1.31
13	0.00	-	-	4.56	3.52	0	2.34	0	8.27	11	1.33
13N	0.00	-	-	5.26	2.70	0	1.16	0	5.38	8	1.49
14	0.00	-	-	-	3.13	0	0.64	0	3.77	0	-
14N	0.00	-	-	1.18	2.30	4	1.00	0	6.69	8	1.20
15	0.00	-	-	-	1.75	0	0.19	0	1.94	0	-
15N	0.00	-	-	-	2.65	6	0.00	-	2.65	6	2.26
16	0.00	-	-	-	0.15	0	0.00	-	0.15	0	-
16N	0.00	-	-	-	0.20	4	0.00	-	0.20	4	20.00
18	0.00	-	-	-	0.02	0	0.56	3	5.36	3	5.17
20	0.00	-	-	-	0.00	-	0.15	1	6.67	1	6.67
21	0.00	-	-	-	0.00	-	0.70	7	10.00	7	10.00
22	0.00	-	-	-	0.00	-	0.80	0	0.80	0	-
23	0.00	-	-	-	0.00	-	1.12	0	1.12	0	-
24	0.00	-	-	-	0.00	-	0.13	0	0.13	0	-
30	0.00	-	-	-	0.00	-	3.87	0	3.87	0	-
31	0.00	-	-	-	0.00	-	2.31	0	2.31	0	-
UNB	0.00	-	-	1.44	5.63	8	0.07	0	29.95	43	1.44
Total	1.96	4	2.04	1.60	22.47	22	18.92	11	85.97	110	1.28

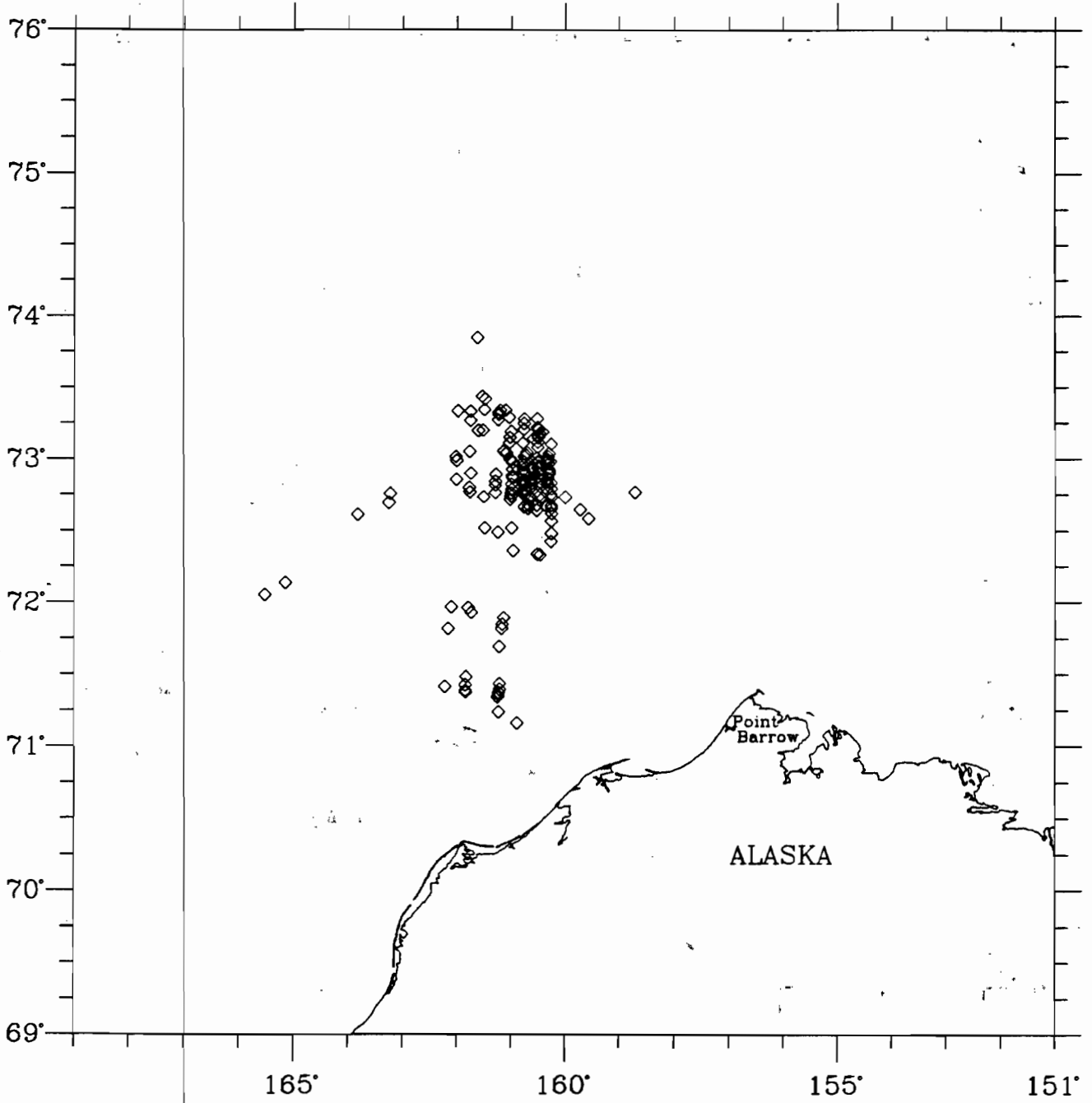

Figure 9. Distribution of 178 sightings of 1,319 walrus, 1990.

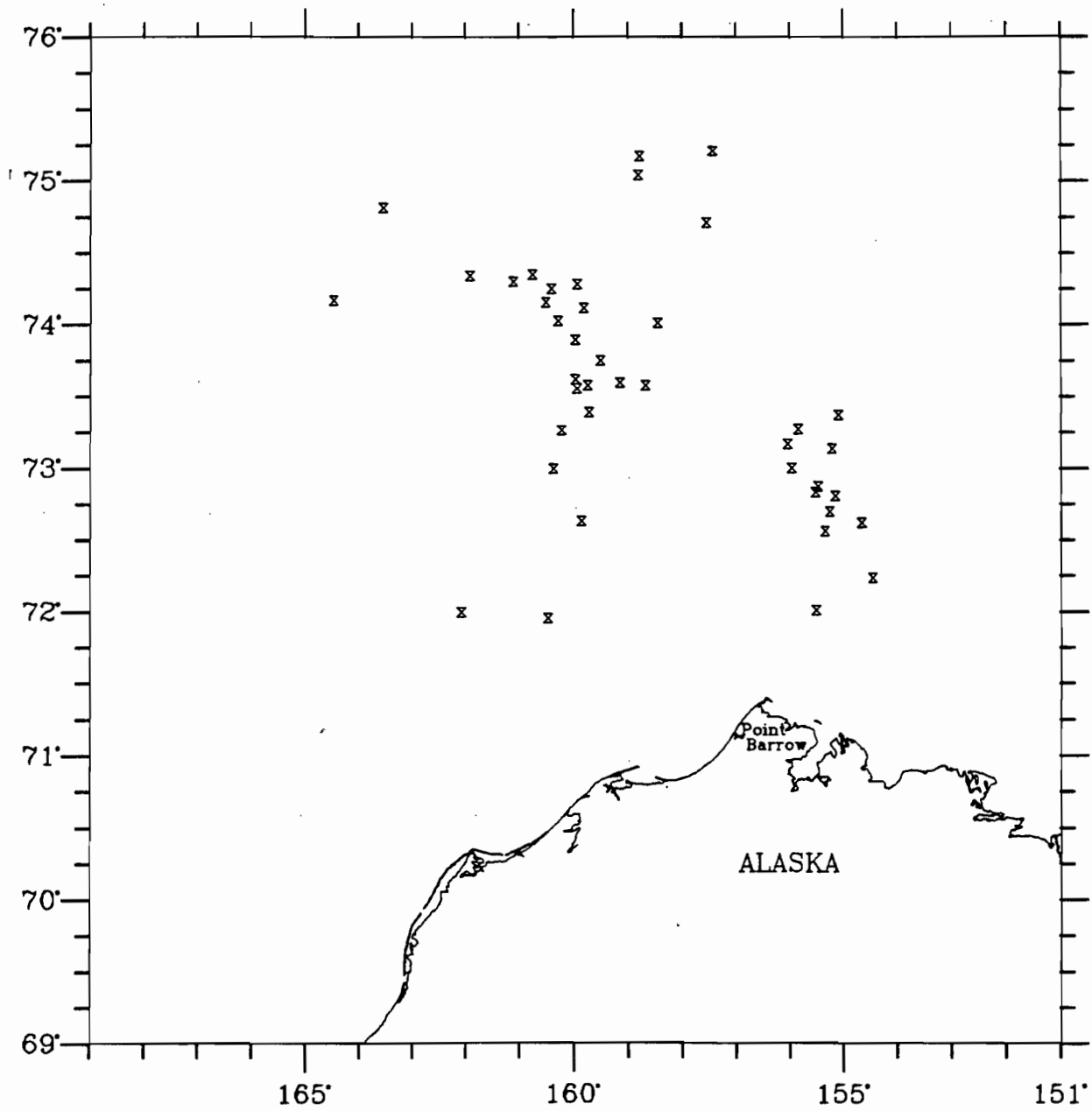

Figure 10. Distribution of 41 sightings of 53 polar bears, 1990.

Table 5. Summary of polar bear sightings, 1990.

Date	Latitude (° N)	Longitude (° W)	Total Number
14 Oct	73 15.5	160 31.6	1
15 Oct	74 06.7	159 49.1	1
15 Oct	74 16.7	159 56.3	1
15 Oct	74 01.1	160 17.1	1
15 Oct	74 14.7	160 24.3	1
15 Oct	74 09.2	160 30.6	1
15 Oct	74 20.7	160 45.6	1
15 Oct	74 17.7	161 06.6	1
15 Oct	74 20.1	161 54.7	1
16 Oct	74 00.4	158 27.8	1
16 Oct	73 34.4	158 41.3	3 (2 cubs)
16 Oct	73 35.3	159 09.4	1
16 Oct	73 44.7	159 31.0	1
16 Oct	73 34.2	159 44.6	1
16 Oct	73 53.4	159 58.2	1
16 Oct	73 36.7	159 58.7	1
16 Oct	73 33.1	159 56.6	1
16 Oct	73 22.9	159 43.1	2 (1 cub)
16 Oct	72 49.8	155 32.0	1
16 Oct	72 52.2	155 29.1	3 (2 cubs)
16 Oct	73 22.1	155 06.0	1
16 Oct	73 16.1	155 51.6	1
16 Oct	73 09.9	156 03.2	1
16 Oct	73 08.0	155 13.3	1
16 Oct	72 59.9	155 59.0	1
16 Oct	72 48.2	155 09.5	2 (1 cub)
17 Oct	75 12.4	157 27.1	3 (2 cubs)
18 Oct	74 42.4	157 33.6	2 (1 cub)
18 Oct	75 10.1	158 47.5	1
18 Oct	75 02.3	158 48.8	1
22 Oct	74 48.7	163 32.5	1
22 Oct	74 09.9	164 28.6	1
26 Oct	72 37.5	159 52.0	1
30 Oct	71 59.4	162 05.0	1
30 Oct	71 57.0	160 28.6	1
1 Nov	72 59.5	160 22.5	2
1 Nov	72 00.4	155 31.6	1
1 Nov	72 41.8	155 16.0	2 (1 cub)
1 Nov	72 33.7	155 21.1	2 (1 cub)
1 Nov	72 14.0	154 27.5	1
1 Nov	72 37.1	154 39.8	1

DISCUSSION AND REVIEW

Survey Effort, Conditions and Bowhead Sighting Summary

Nearly 623 hours of aerial survey effort have been conducted in the study area from mid-September through mid-November 1980-90, during MMS-funded studies (Table 6). Survey effort has varied greatly among years, from a low of less than 0.5 hours in 1981 to a high of nearly 134 hours in 1989. Annual differences in survey effort resulted from varied task priorities, as summarized in Moore and Clarke (1990).

Annual ice conditions have ranged from light, with little or no ice in the study area during the survey season, to heavy, when the study area had >50% ice cover throughout the survey season (Table 6). An ice edge frequency map for the study area depicts ice conditions commonly encountered in mid-October, with the mid-October 1990 ice edge added for comparison (Fig. 11). The inflow of relatively warm southern water through Bering Strait directly influences the irregular contour of the ice edge. Embayments in the ice edge tend to occur in the same places each year over relatively deep-water troughs in the sea floor, for example near 167°W (Paquette and Bourke 1981; Bourke 1983). Current flow and ice conditions in the Chukchi Sea vary greatly with wind conditions (Aagaard 1987; Muench et al. 1991). Although the underlying cause for the northward flow through the Bering Strait is the higher sea level in the North Pacific relative to the Arctic Ocean, major differences in flow rate are driven atmospherically with summer transport about 50% greater than during the winter (Aagaard 1987). The median ice-free period is 84 days at Barrow, 91 days at Point Lay and 154 days at the Bering Strait (Stringer and Groves 1987). These medians were greatly exceeded in 1990.

There were 240 sightings of 520 bowhead whales in the study area from mid-September through October 1982-90 (Table 6). No bowheads or belukhas were seen in the study area in 1980 or 1981 during 20.3 hours of survey. Therefore, the bowhead whale and belukha data summary which follows is based on the 1982-90 data base. The reader is directed to Moore and Clarke (1990) for a review of gray whale, walrus and polar bear data.

Table 6. Summary of survey effort, general ice conditions and bowhead whale sightings (SI) and number (No.) in the study area, 1980-90.

Year	Survey Effort (hours)	Ice Condition	Bowhead Whales	
			(SI)	(No.)
1980	19.93	heavy	0	0
1981	0.37	average	0	0
1982	31.71	average	19	30
1983	61.96	heavy	34	50
1984	38.10	average	45	192
1985	32.11	avg/hvy	10	10
1986	79.20	light	11	15
1987	87.85	light	24	32
1988	51.95	heavy	25	55
1989	133.72	light	58	117
1990	85.96	light	14	19
1980-90	622.86	--	240	520

Bowhead Whale

Distribution and Abundance

There were 46 sightings of 187 bowhead whales in the study area from 16 to 30 September; 132 sightings of 246 whales from 1 to 15 October; 62 sightings of 87 whales from 16 to 31 October, and 240 sightings of 520 whales overall 1982-90 (Fig. 12). The overall distribution highlights the importance of the nearshore waters between Point Barrow and Smith Bay, and southwest of Point Barrow to about 120 km (65 nmi) northwest of Icy Cape.

Surveys initiated in waters north of 72° N latitude in 1987 (12N and 13N) were expanded in 1988 (12N - 16N). One bowhead was seen in block 12N on 27 September 1987; none were seen in the northern blocks in 1988, a heavy-ice year. There were four bowhead sightings in 1989 and two sightings in 1990 in northern blocks, with one sighting north of the study area in 1990. In addition, there were three bowhead sightings in northern areas by U.S. Fish and Wildlife Service (USFWS) biologists (see ●, Fig. 12) while conducting walrus surveys over the Chukchi Sea in 1985 (Ljungblad et al. 1986a).

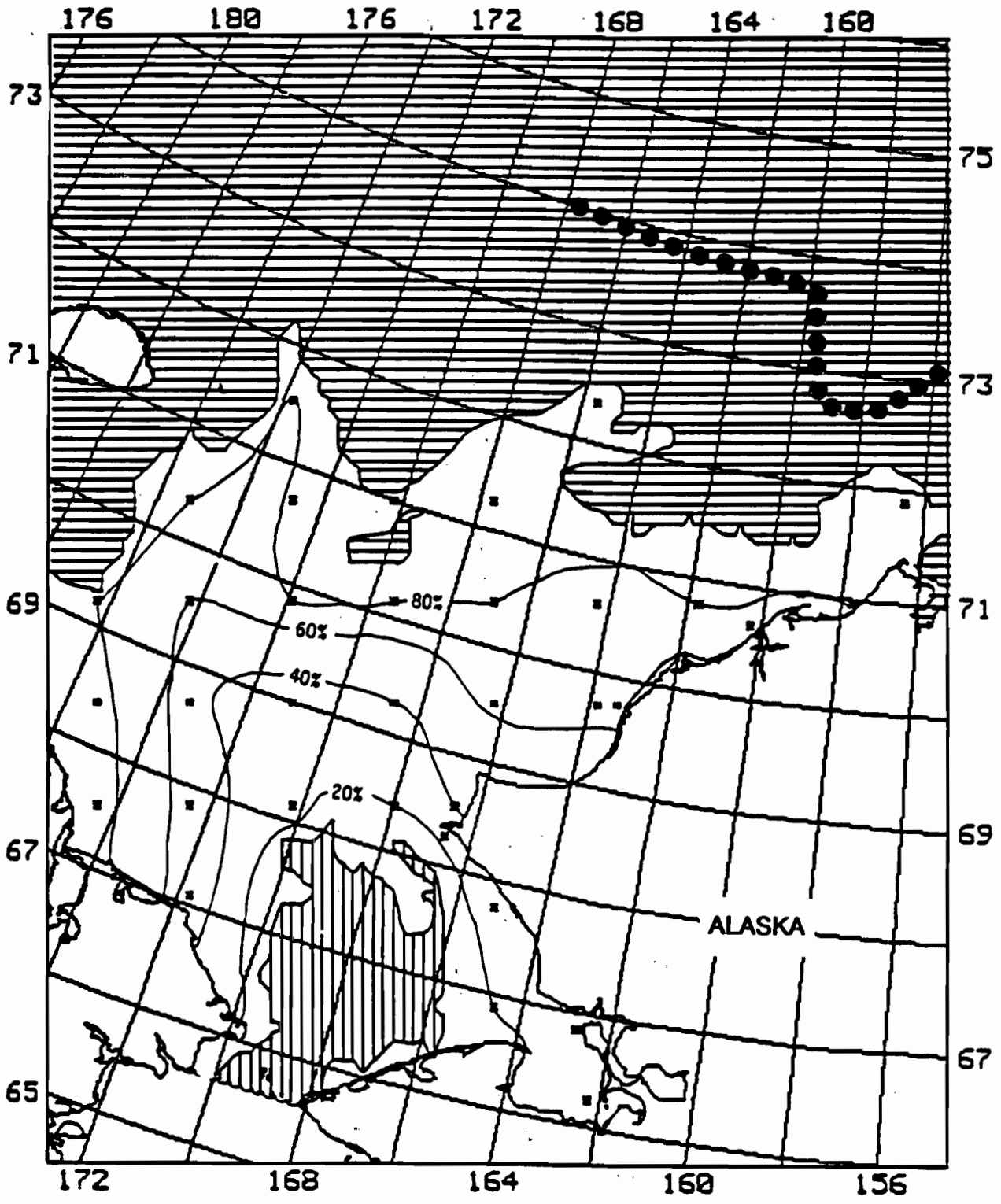

Figure 11. Chukchi Sea ice-edge frequency map for the second week of October, derived from a 12-year (1972-1983) satellite data base (from Stringer and Groves 1987). The isopleths represent the frequency with which oceanic locations were within the ice edge in mid-October; vertical lines represent areas that were ice-free in all years and horizontal lines depict areas that were ice covered in all years; ● indicates the ice edge 13-25 October 1991.

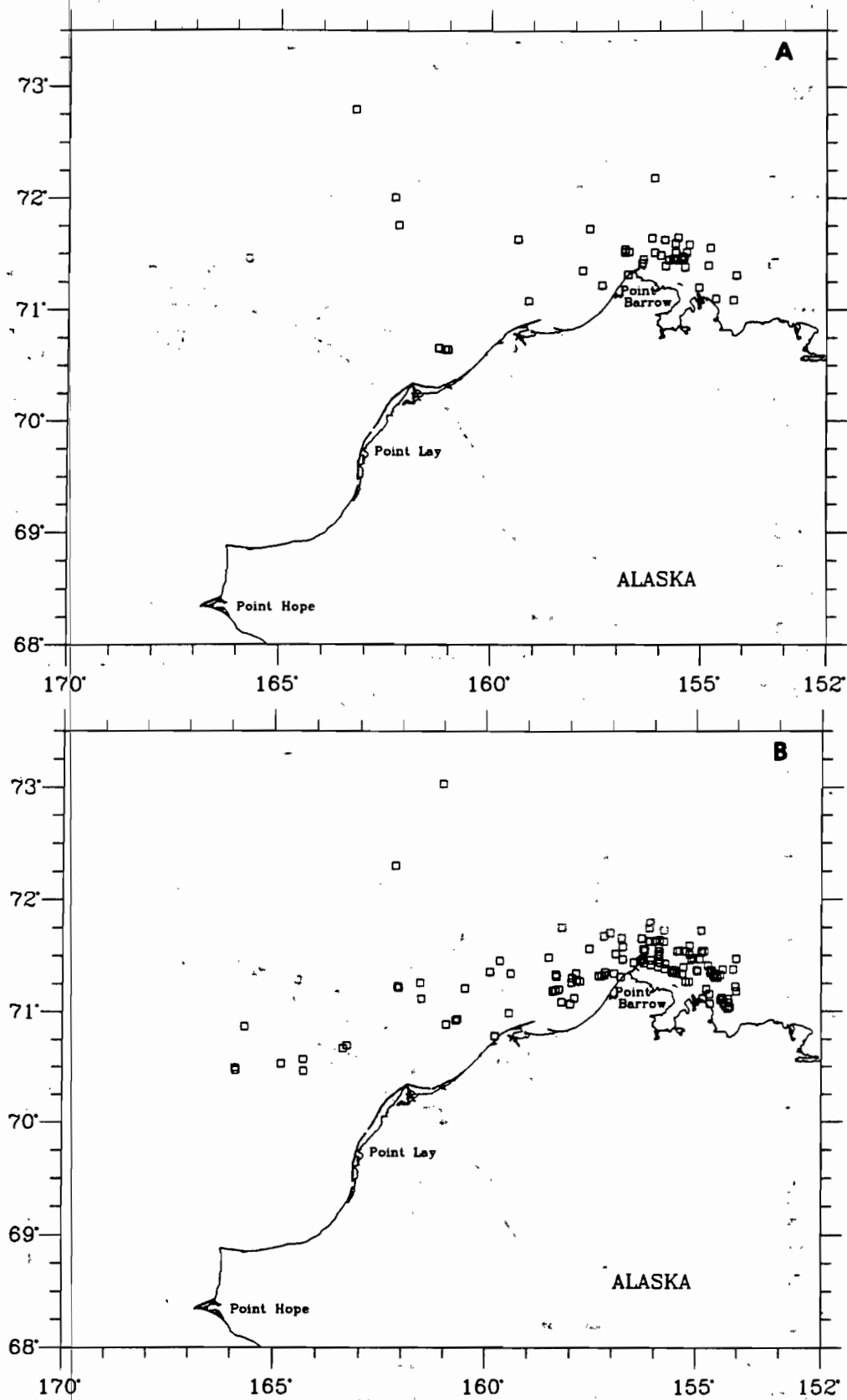

Figure 12. Cumulative (1982-90) bowhead whale distribution depicting 46 sightings of 187 whales, 16-30 September (A); 132 sightings of 246 whales, 1-15 October (B);

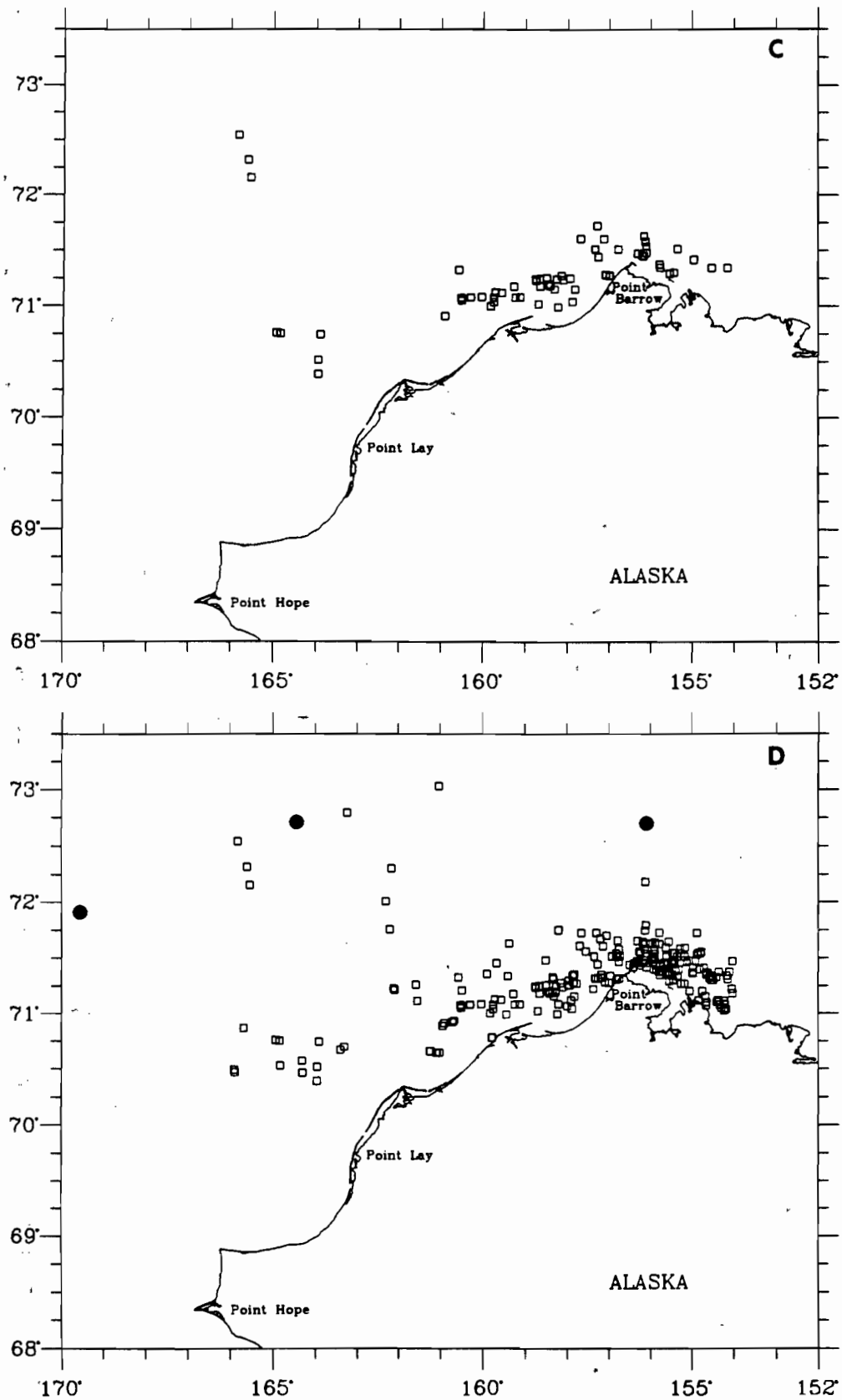

Figure 12 (cont). 62 sightings of 87 whales, 16-31 October (C); and 240 sightings of 520 whales (D). [● = USFWS sightings 1985]

Table 7. Cumulative (1982-90) bowhead whale relative abundance (WPUE=no. whales/survey hour) in the Chukchi Sea study area by survey block¹.

Block	16-30 Sept			1-15 Oct			16-31 Oct			1-15 Nov			Total		
	Hrs	BH	WPUE	Hrs	BH	WPUE	Hrs	BH	WPUE	Hrs	BH	WPUE	Hrs	BH	WPUE
12	37.61	174	4.63	57.27	162	2.83	35.30	23	0.65	1.07	0	0	131.25	359	2.74
12N	8.06	1	0.12	10.94	0	0	7.32	0	0	2.81	0	0	29.13	1	0.03
13	39.45	6	0.15	49.24	52	1.06	40.00	39	0.98	2.34	0	0	131.03	97	0.74
13N	5.75	0	0	8.51	0	0	9.20	0	0	1.16	0	0	24.62	0	0
14	16.62	1	0.06	27.51	9	0.33	10.71	5	0.47	0.64	0	0	55.48	15	0.27
14N	3.79	1	0.26	9.70	1	0.16	2.71	0	0	1.00	0	0	17.20	2	0.12
15	8.16	0	0	10.99	0	0	6.36	0	0	0.19	0	0	25.70	0	0
15N	3.95	1	0.25	7.22	0	0	6.38	3	-0.47	0.00	-	-	17.55	4	0.23
16	0.73	0	0	3.18	0	0	3.54	0	0	0.00	-	-	7.45	0	0
16N	3.08	0	0	3.92	0	0	0.20	0	0	0.00	-	-	7.20	0	0
17	8.08	3	0.37	22.78	3	0.13	10.92	1	0.09	0.00	-	-	41.78	7	0.17
18	4.63	0	0	12.79	14	1.09	11.21	16	1.43	0.56	0	0	29.19	30	1.03
19	0.00	-	-	0.94	0	0	0.04	0	0	0.00	-	-	0.98	0	0
20	3.27	0	0	4.15	0	0	4.55	0	0	0.15	0	0	12.12	0	0
21	0.00	-	-	1.71	0	0	1.61	0	0	0.70	0	0	4.02	0	0
22	3.14	0	0	3.22	0	0	5.22	0	0	0.80	0	0	12.38	0	0
23	0.00	-	-	0.23	0	0	2.85	0	0	2.23	0	0	5.31	0	0
24	0.00	-	-	0.00	-	-	0.34	0	0	4.17	0	0	4.51	0	0
25	0.00	-	-	0.00	-	-	0.51	0	0	1.32	0	0	1.83	0	0
30	0.00	-	-	0.85	-	-	1.97	0	0	4.64	0	0	7.46	0	0
31	0.00	-	-	0.00	0	0	0.47	0	0	5.99	0	0	6.46	0	0
Total	146.32	187	1.28	235.15	241	1.02	161.41	87	0.55	29.77	0	0	572.65	515	0.90

¹ Excludes 5 bowheads seen during 29.92 hours of survey effort in unblocked areas, 1990

Although few in number, these ten sightings suggest that in some years, some bowheads cross the Chukchi Sea along a northern migration route.

Cumulative (1982-90) relative abundance was highest in block 12 (WPUE = 2.74), block 13 (WPUE = 0.74) and block 18 (WPUE = 1.03; Table 7). These comparatively high indices reflect the general pattern of distribution, with most whales seen nearshore northeast of Point Barrow, and dispersion southwest from Point Barrow. Lesser cumulative abundance indices were calculated for block 14 (WPUE = 0.27), block 14N (WPUE = 0.12), block 15N (WPUE = 0.23) and block 17 (WPUE = 0.17).

Cumulative (1982-90) relative abundance was also calculated as the number of bowheads seen per 100 transect-kilometers (t-km) for sub-blocks that were roughly 1,150 km² (15°N latitude by 1° W longitude) (Fig. 13). Abundance was calculated only for sub-blocks with at least 50 km (ca. 0.2 h) of transect survey effort during periods of good sea

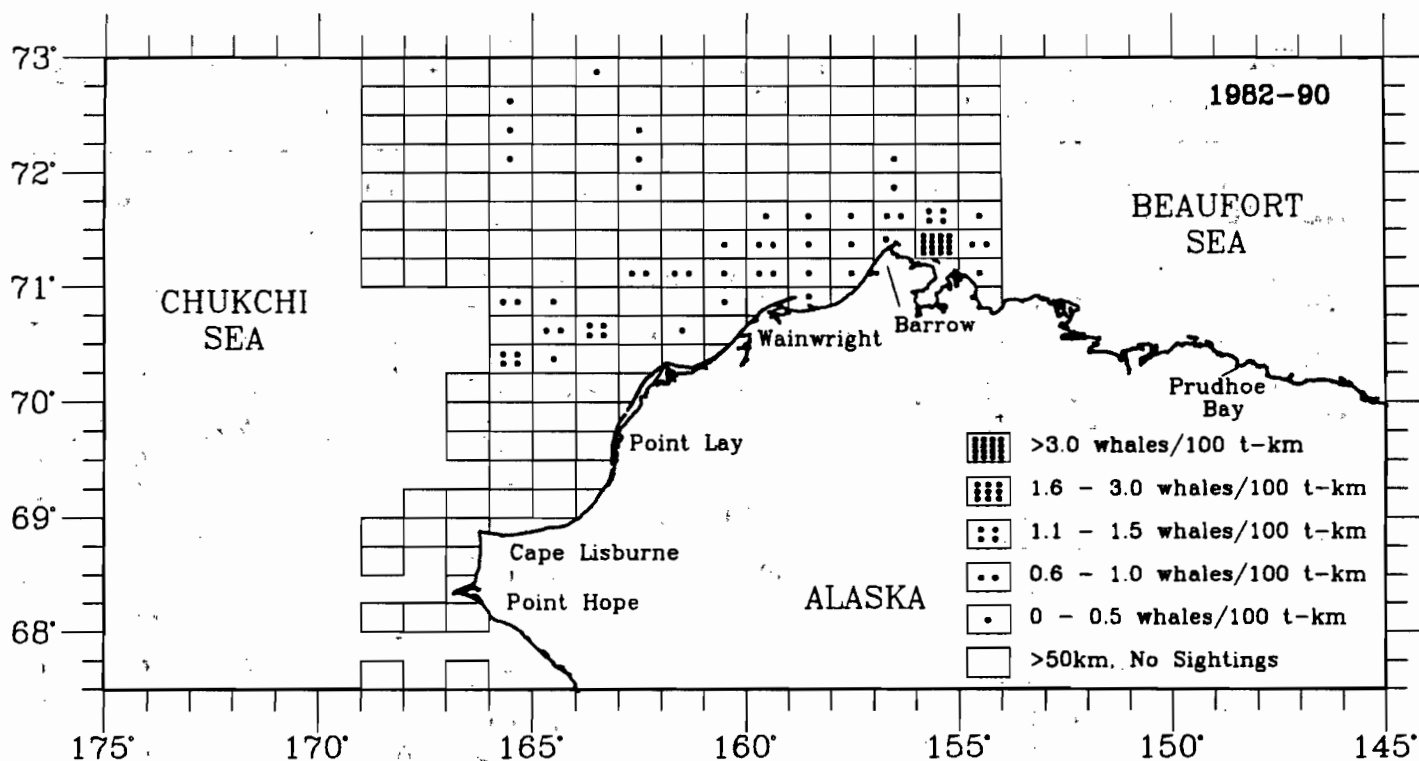

Figure 13. Cumulative (1982-90) bowhead whale relative abundance by sub-block.

conditions (Beaufort ≤ 4); these methods were adopted from Reilly and Thayer (1990). Relative abundance was high in comparatively small areas, although a much larger total area was surveyed with at least the minimum level of effort. In the western Beaufort Sea, abundance was highest in sub-blocks east and north of Barrow. In the northeastern Chukchi Sea, abundance was highest in sub-blocks southwest of Barrow, with lesser indices in sub-blocks from 250 to 400 km northwest of Barrow. This pattern of relative abundance suggests that whale distribution is bifurcated in the northeastern Chukchi Sea, with roughly 50-100 km separating 'northern' and 'southern' components in waters west of 163°W longitude.

Migration Route

A primary task of this study is to describe the bowhead fall migration route across the Chukchi Sea and to determine if the route is affected by OCS oil and gas exploration activities. Two types of analysis support a description of migration route; an analysis of swimming direction and a line-fitting analysis of random bowhead sightings. Bowhead whale swimming direction in the western Beaufort Sea ($154\text{-}157^\circ\text{W}$) was significantly clustered about 280°T ($p < 0.001$, $n = 101$), while in the Chukchi Sea ($157\text{-}169^\circ\text{W}$) swimming direction was clustered about 251°T ($p < 0.001$, $n = 68$); Fig. 14). The strong statistical significance in both data sets implies that most bowheads approach Point Barrow on a westerly course, then turn and swim southwest after passing the point.

A plot of random bowhead sightings ($n = 59$) west of Point Barrow (Fig. 15A) depicts the same general pattern of distribution as that for all whales (see Fig. 12). Only random sightings west of Point Barrow (ca. $156^\circ 30'\text{W}$) can be used to statistically test for differences in migration route between years, however, so it is this smaller data set that is analyzed to describe the Chukchi Sea migration route. Migration route across the northwestern Chukchi Sea was described by fitting lines to cumulative (1982-90) random sightings data (Fig. 15B), using the method of least squares (Zar 1984). Two lines were fit, one for random sightings south of 72°N latitude ($n = 53$) and the second for sightings north of 72°N latitude ($n = 6$), to reflect the apparent bifurcation in bowhead distribution and relative abundance (see Figs. 12 and 13). The line describing the provisional 'southern' route suggests that whales swim southwest from Barrow and cross the northeastern Chukchi Sea on a course that takes them near Herald Shoal (ca. $70^\circ 30'\text{N}$, 171°W). The line describing the provisional 'northern' route suggests that some whales swim northwest across the northern Chukchi Sea on a course that takes them north of Herald and Wrangel islands (ca. $71^\circ 30'\text{N}$, between 175°W - 180°W). Swimming direction analysis complemented the line-fit analysis of migration route(s). Swimming direction was strongly clustered about 250°T ($n = 39$, $z = 23.05$, $r = 0.77$; $p < 0.001$) for whales along the provisional 'southern' route; direction was significantly clustered about 271°T ($n = 6$, $z = 3.16$, $r = 0.73$; $p < 0.05$) for whales along the provisional 'northern' route. Lines could not be fit to 1990 data because only four random transect sightings were made in the eastern Chukchi Sea; two each in the provisional 'northern' and 'southern' data sets. However, there was no significant difference among annual line-fit migration routes described for 1982-89 data (Moore and Clarke 1990).

Beaufort Sea
n = 101

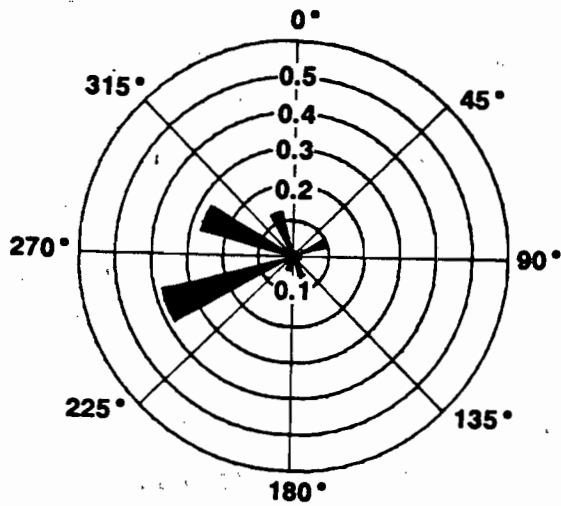

$a = 280 \cdot T$, $r = 0.56$
 $z = 32.12$, $p < 0.001$

Chukchi Sea
n = 68

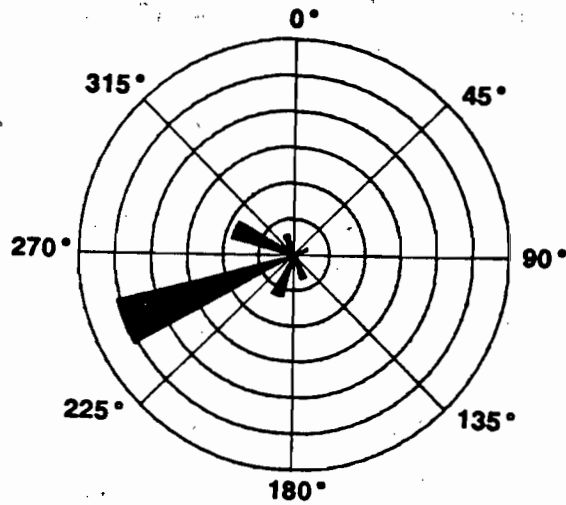

$a = 251 \cdot T$, $r = 0.71$
 $z = 34.76$, $p < 0.001$

Figure 14. Cumulative (1982-90) bowhead whale swimming direction in the western Beaufort and northeastern Chukchi seas.

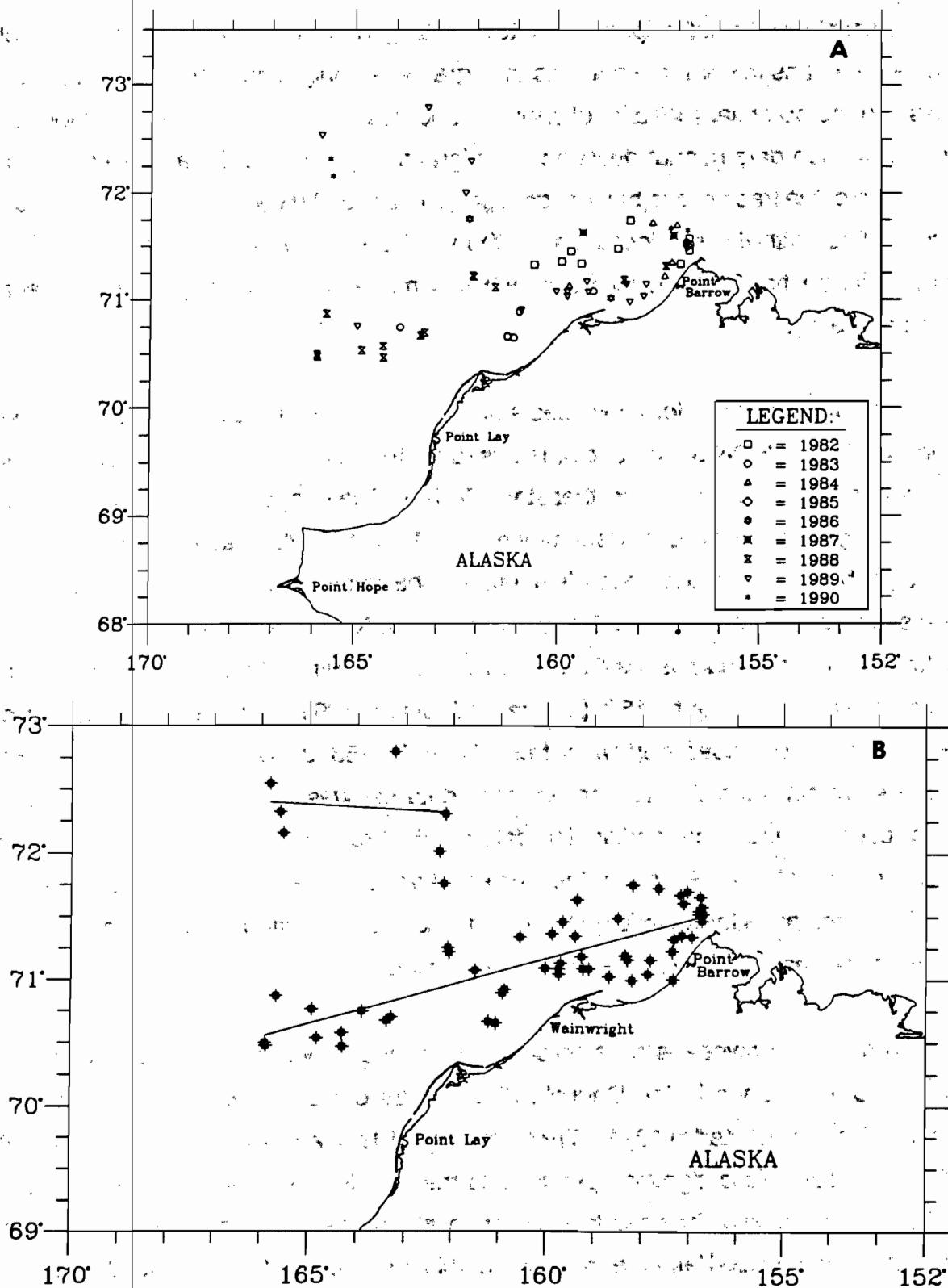

Figure 15. Cumulative (1982-90) distribution of 59 sightings of 82 bowhead whales seen on random transects west of Point Barrow (156°30'W) (A); best-fit lines depicting provisional 'northern' and 'southern' migration route(s) across the northeastern Chukchi Sea (B).

Describing the fall migration route by fitting lines to bowhead distribution plots provides a means to compare patterns of migration among years, an important aspect of assessing the potential impact of offshore oil and gas activities on whale behavior. Lines fit to distribution data cannot describe the migration route of individual whales, however. For example, the track of two bowheads tagged in fall 1989 diverted offshore in the central Beaufort Sea, with the last locations for the whales roughly 100 km northeast of Point Barrow, suggesting that an individual whale's migration route may be quite variable (Wartzok, 1990).

The division of random bowhead sightings into 'northern' and 'southern' data sets, using 72°N, 156°30'W as the origin, is based on the apparent bifurcation of distribution and relative abundance in the northeastern Chukchi Sea suggested in Figures 12 and 13. Line-fit analysis was also undertaken using 71°30'N, 156°30'W as the origin, based on the lack of bifurcation in bowhead distribution in the western Beaufort Sea (i.e. bowheads apparently pass close to Point Barrow [ca. 71°30'N] as they enter the northeastern Chukchi Sea). This analysis resulted in a provisional 'southern' route that was essentially the same as that in Figure 15B (Moore and Clarke 1991). However, the provisional 'northern' route extended northwest from 71°30'N, 156°30'W to ca. 72°30'N, 166°W, but the swimming direction for the northern data set was directed southwest (261°T). These results suggest that partitioning data at 72°N results in line-fit analysis that better reflects the swimming behavior of the whales. Additional data partitioning and line-fitting statistical techniques for describing bowhead whale fall migration route(s), and for testing for differences among years, are being investigated.

The route bowheads take through the central Chukchi Sea is unknown. Fall sightings of bowheads in the Chukchi Sea outside our study area come mainly from vessel cruises conducted in 1974-75 (Braham et al. 1984), and 1979-80 (Miller et al. 1986), and from opportunistic sightings provided to the U.S. National Marine Fisheries Service (NMFS). Hundreds of bowheads were seen along the northern Chukotka peninsula between Cape Serdtse-Kamen and Cape Schmidt in October 1974-75, mid-October 1979 and mid-September 1980 (Fig. 16). In addition, there were scattered sightings of tens of whales northeast and southeast of Wrangel Island in 1979, and northeast of Cape Dezhneva in 1990. It is tempting to speculate that bowheads swimming along the provisional 'southern' route in the eastern Chukchi Sea continue to swim southwest and

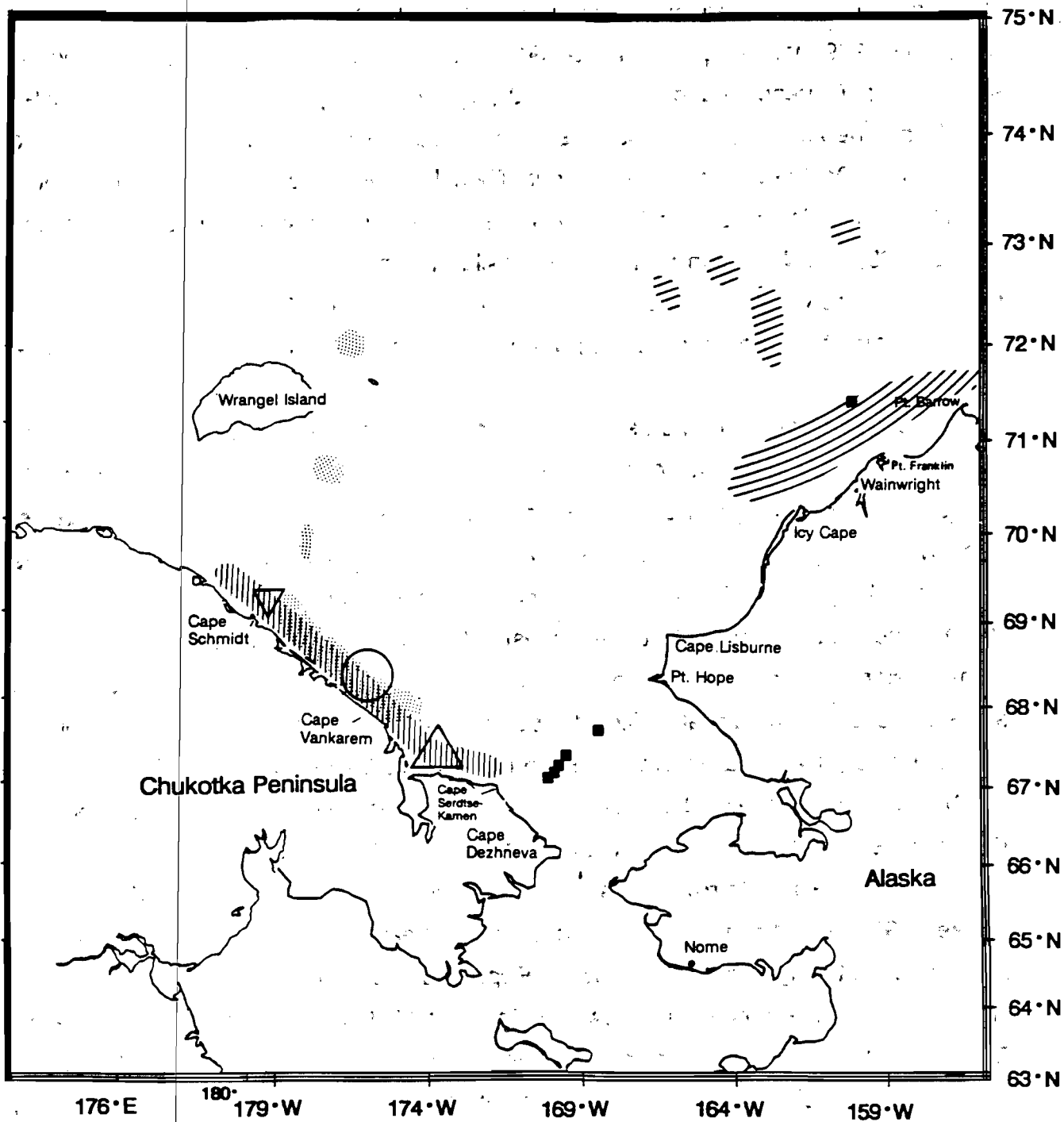

Figure 16. Summary of fall bowhead whale distribution in the Chukchi Sea from surveys conducted since the mid-1970s: [//]: 20 Sep-29 Oct 1982-90 (this study); [••••] 13-18 Oct 1979 (123 bowheads, Miller et al. 1986); [||||] 19-23 Sep 1980 (283 bowheads, Miller et al. 1986); [○] ca. 50 bowheads Oct 1979; 200 bowheads Sep 1980 (Miller et al. 1986); [△] 140 bowheads Oct 1974-75 (Berzin, in Braham et al. 1984); [▽] ca. 23 bowheads Oct 1974-75 (Berzin, in Braham et al. 1984); [■] ca. 41 bowheads 8-12 Oct 1990 (NMFS, POP).

cross the central Chukchi Sea near Herald Shoal enroute to the Chukotka peninsula. However, none were seen there during vessel surveys through the central Chukchi Sea in October 1979, nor in September 1980 (Miller et al. 1986). Sightings of bowheads in the south-central Chukchi Sea in October 1990 (Figs. 7 and 16) suggest that some whales may follow the Alaskan coast south as far as about Point Hope, then head southward toward Cape Dezhneva or the Bering Strait. There has been little aerial survey effort south of 70°N latitude in the Chukchi Sea until late October or early November (Moore and Clarke 1990), which may in part, be responsible for the lack of fall bowhead sightings there. When surveys have been flown south of 70°N in early fall, high sea states often curtailed flight effort and therefore the possibility of describing bowhead occurrence there.

Bowheads migrating across the Chukchi Sea in fall may join whales that summer in the western Chukchi Sea. Although Miller et al. (1986) concluded that bowheads do not summer in the Chukchi Sea because none were seen there during a summer cruise, Bessonov et al. (1990) and Bogoslovskaya et al. (1982) maintain that bowheads migrate northwest along the Chukotka coast in spring, summer in the western Chukchi Sea, then migrate southeast along the Chukotka coast in fall. Summaries of bowhead occurrence in the western Chukchi Sea were based on reports by Chukotka residents (Bessonov et al. 1990; Bogoslovskaya et al. 1982). It is perhaps noteworthy that the aggregation of 200 bowheads near Cape Vankarem was seen between 19-23 September 1980 (Miller et al. 1986), one day after the peak sighting-rate day (18 September 1980) in the Beaufort Sea (Ljungblad et al. 1986c) and roughly two-weeks prior to the passage of the 'first pulse' of bowheads near Point Barrow that is usually seen in early October each fall (Moore and Clarke 1990). Miller et al. (1986) suggested that heavy ice cover in 1980 could have influenced the timing of the fall migration. Reports of the effect of ice cover on migration timing are somewhat ambiguous, however. In spring 1980, heavy ice conditions at Bering Strait apparently delayed the northward migration by about three weeks (Ljungblad et al. 1986c). Conversely, bowheads readily swam under and broke through new ice up to 18 cm thick, but swam around a thick (10-20 m) ice flow during the 1985 spring migration near Barrow (George et al. 1989). Thus ice type, or thickness, may be more important than ice cover in influencing a whale's migration track. Further, whales may be able to infer something about the draft of ice in their path by acoustic reflection of their calls (Ellison et al. 1987).

The route bowheads take across the Chukchi Sea may be influenced by currents as well as ice. Two principal water masses enter the Chukchi Sea through Bering Strait, the saline Bering Sea water (BSW) and the low-salinity Alaskan coastal water (ACW) (Aagaard 1987). The inflow of the two water masses diverges near the latitude of Point Hope (Fig. 17). Both flow northward along bathymetrically guided routes, the ACW to the northeast along the Alaskan coast and Hanna Trough, and the BSW through Herald Canyon in the central Chukchi Sea. These currents meet resident Chukchi water (RCW) associated with the ice edge in the northern Chukchi Sea. Fronts formed where differing water masses abut are often the sites of high biological productivity due to upwelling (Bowman and Esaias 1978; Parsons et al. 1977), and may serve to concentrate whale prey (Nasu 1974; Gaskin 1982; Fissel et al. 1987). A sharply-defined surface boundary is formed roughly parallel to the ice edge where ACW meets RCW (Bourke 1983). Fronts do not always coincide exactly with the ice edge, however, because wind-driven ice moves faster than the fronts and can overlie or drift some distance away (ca. 10 km) from the front. At the core of the ACW intrusion, warm southern water often flows strongly enough to penetrate far into the ice edge. The ACW inflow reaches a maximum in late August, then abates in September with stationary filaments of warm water measured in October as far north as 73°20'N north of Bering Strait and to 72°30'N north of Point Barrow (Ahlnas and Garrison 1984).

The provisional 'southern' and 'northern' bowhead migration routes may be associated with fronts along the ACW and RCW in the northern Chukchi Sea. In addition to concentrating prey, fronts present salinity and temperature differences between water masses which may provide migration cues. Bowheads continue to feed during the fall migration in the Beaufort Sea (Ljungblad et al. 1986a), and seem to rely on finding relatively dense patches of prey, which were sometimes associated with fronts in the eastern Beaufort Sea (Richardson 1987). Migrating along oceanographic fronts in the Chukchi Sea may provide bowheads with feeding opportunities throughout the fall. There is great annual variation in the location of fronts and the ice edge in the Chukchi Sea (Paquette and Bourke 1981), apparently in response to wind conditions (Aagaard 1987). For example, the extreme southward extent of ice in the Chukchi Sea in 1988 was due to north-northwesterly winds that held the pack ice against the shore (Muench et al. 1991). Wind can also cause a reversal of flow of ACW near Barrow (Johnson 1989). If the bowhead migration route is, in part, current-influenced, annual variation in atmospheric

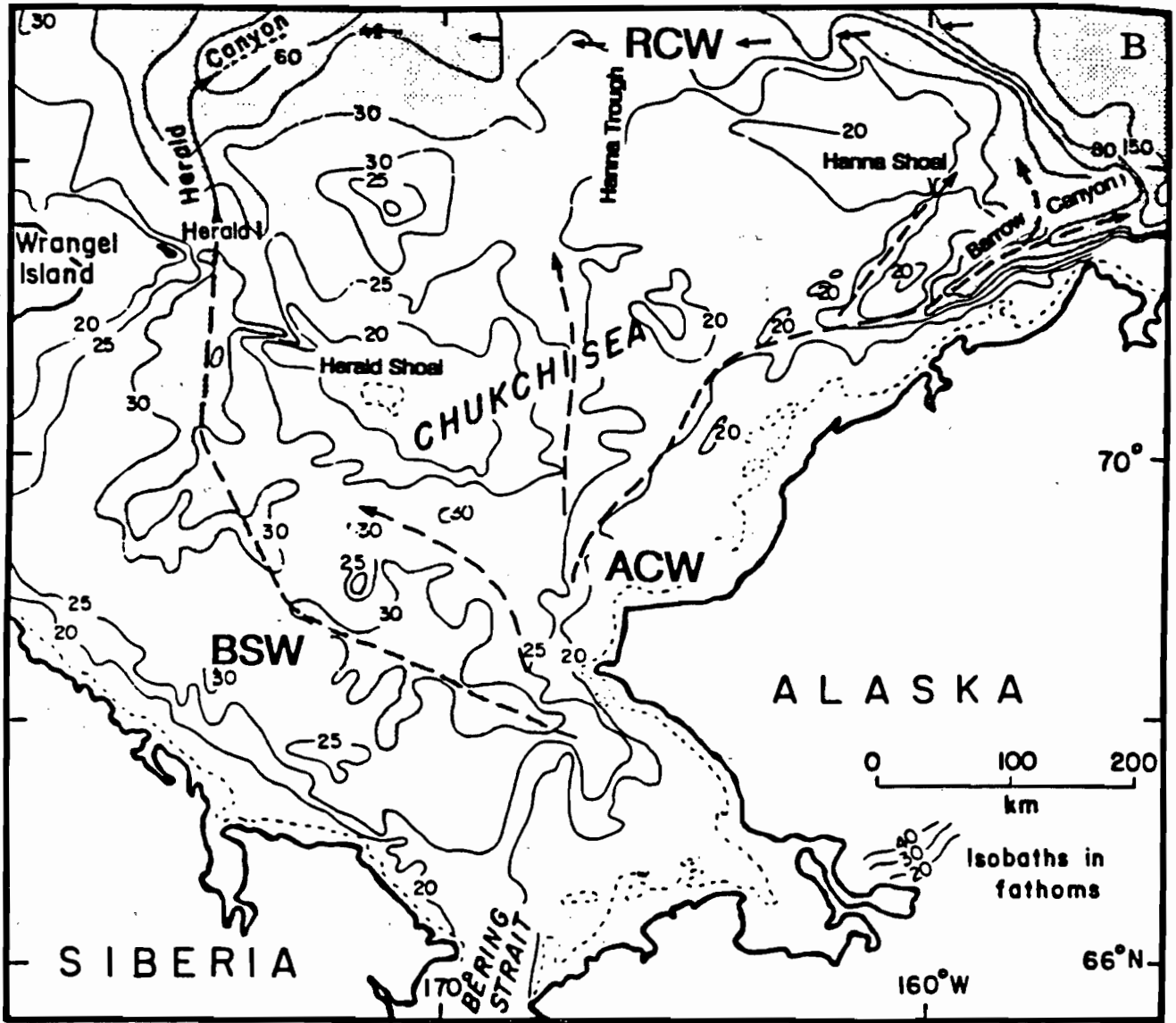

Figure 17. Patterns of current flow in the Chukchi Sea.

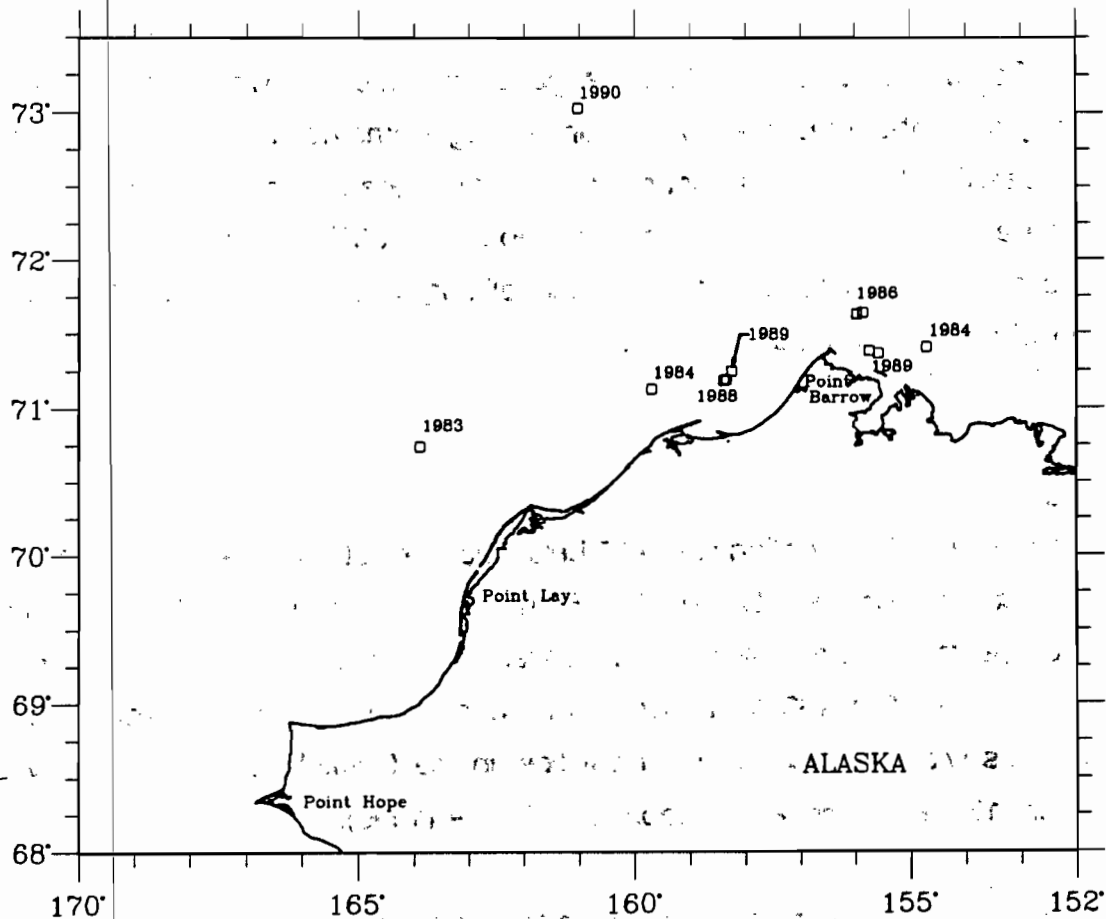

Figure 18. Cumulative (1982-90) distribution of 11 sightings of 13 bowhead whale calves.

conditions may cause variation in migration route. Further study of the provisional migration routes described here should include associations with oceanographic processes.

Calf Sightings

There have been 11 sightings of 13 calves in the study area 1982-90 (Fig. 18). Calf distribution was similar to that for all whales. Especially noteworthy were calf sightings at the extremes of the observed bowhead distribution: one calf approximately 180 km west of Wainwright in October 1983, and two calves approximately 265 km northwest of Point Barrow in October 1990. Calves were always associated with other whales, either in cow-calf pairs ($n=8$) or within a group of two to 17 non-calf whales ($n=5$).

Calves were not seen in the study area in September. Ten calves were seen in the first half of October and three calves in the latter half of October. There was no significant difference ($\chi^2 = 0.06$; $p < 0.50$) in calf ratio between early October (10 calves/246 whales)

and late October (3 calves/87 whales) suggesting that calves were seen with equivalent frequency throughout October. Although photogrammetric studies of bowheads in the eastern Beaufort Sea suggest that cows with calves are spatially segregated from other bowhead age-classes (Cubbage and Calambokidis 1987), neither spatial nor temporal segregation has been described during the fall migration (Clarke et al. 1987) except by Eskimo whalers (Braham et al. 1984).

Other Marine Mammals

Belukha

There were 367 sightings of 3,497 belukhas in the study area in late September and October 1982-89 (Fig. 19). Over half (58%, $n=2,024$) were seen in 1983 and 1988, both heavy-ice years. Belukha distribution appears to bifurcate west of Point Barrow then converges near 167° - 169° W between 71° and 72° N. This convergence generally corresponds with the pattern of current flow in the Chukchi Sea depicted by Bourke (1983; Fig. 17), as described in Moore and Clarke (1990).

Swimming direction for belukhas in the western Beaufort Sea (154 - 157° W) was significantly clustered about 248° T ($p<0.001$), while in the Chukchi Sea swimming direction was clustered about 263° T ($p<0.001$; Fig. 20). These results suggest that belukhas swim southwest across the western Beaufort Sea, then take up a more westerly heading to cross the Chukchi Sea.

Highest belukha abundance was calculated for block 12 (WPUE = 11.34) and block 13 (WPUE = 9.41), with relatively high indices for all northernmost blocks (Table 8). The higher indices in the northern blocks (12N-16N) when compared with lower indices in blocks 14, 15, and 16 reflect the bifurcated belukha distribution. Low abundance indices in survey areas in the southern Chukchi Sea may be due to the timing of surveys relative to the belukha migration. Fall belukha sightings in blocks 20 and 21 were recorded for the first time in 1990. Belukha migration west from the Canadian Beaufort Sea apparently begins in mid-August (Harwood and Ford 1983; Norton and Harwood 1985), with the peak of the fall migration through the western Alaskan Beaufort Sea (150 - 157° W) in late September (Clarke and Moore 1989). Substantial numbers of belukhas may not pass through the southern Chukchi Sea until late October or early November, when surveys have either been directed toward the Hope Basin area, or completed.

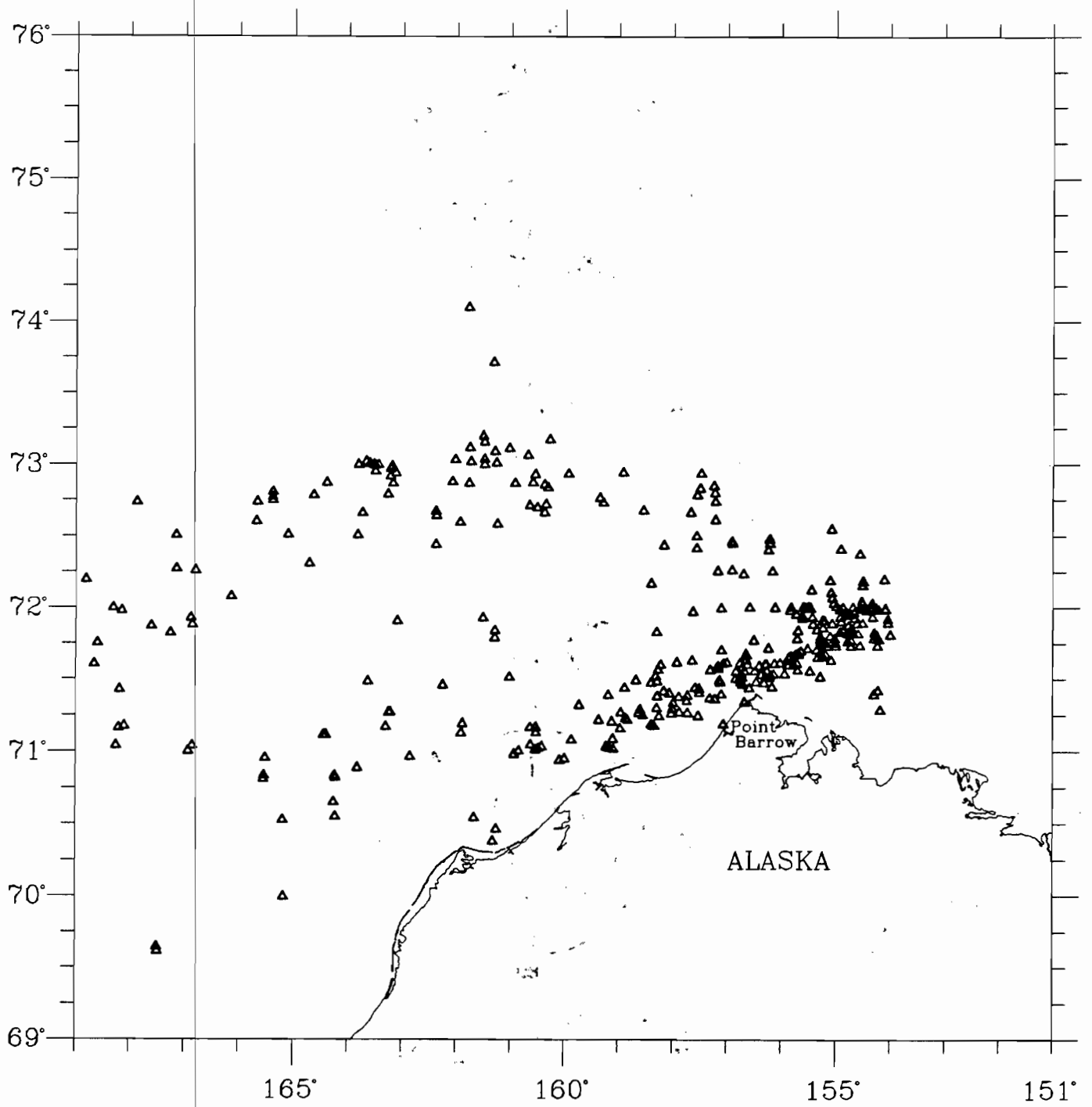
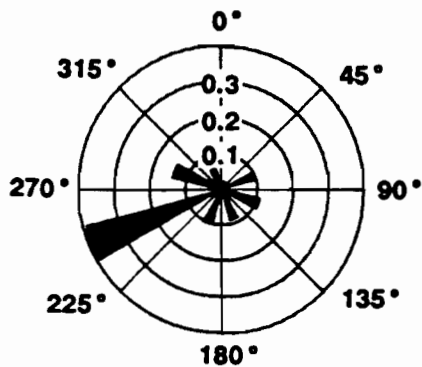

Figure 19. Cumulative (1982-90) distribution of 367 sightings of 3,497 belugas.

Beaufort Sea
n = 122



a = 248·T, r = 0.36
z = 16.22, p < 0.001

Chukchi Sea
n = 153

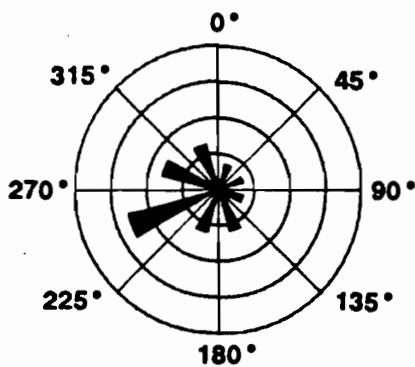

a = 263·T, r = 0.29
z = 12.98, p < 0.001

Figure 20. Cumulative (1982-90) belukha swimming direction in the western Beaufort and northeastern Chukchi Sea.

Table 8. Cumulative (1982-90) belukha relative abundance (WPUE = no. whales/survey hour) in the Chukchi Sea study area by survey block.

Block	Hours	No. Belukha	WPUE
12	131.25	1489	11.34
12N	29.13	171	5.87
13	131.03	1233	9.41
13N	24.62	87	3.53
14	55.48	102	1.84
14N	17.20	106	6.16
15	25.70	18	0.70
15N	17.55	94	5.36
16	7.45	26	3.49
16N	7.20	75	10.42
17	41.78	15	0.36
18	29.19	30	1.03
19	0.98	0	0
20	12.12	1	0.08
21	4.02	7	1.74
22	12.38	0	0
23	5.31	0	0
24	4.51	0	0
25	1.83	0	0
30	7.46	0	0
31	6.46	0	0
Total	572.65	3454	6.03

LITERATURE CITED

- Aagaard, K. 1987. Physical oceanography of the Chukchi Sea: an overview. OCS Env. Assess. Program: Chukchi Sea Information Update, June 1987: 3-10.
- Ahlnas, K. and G.R. Garrison. 1984. Satellite and oceanographic observations of the warm coastal current in the Chukchi Sea. *Arctic* 37(3): 244-254.
- Batschelet, E. 1981. Circular statistics in biology. Academic Press, New York, 371 pp.
- Bauer, M.F. 1989. American Digital Cartography: Digital Map Users Guide, AutoCAD Edition, 38 pp.
- Bessonov, B., V.V. Melnikov, and V.A. Bobkov. 1990. Distribution and migration of cetaceans in the Soviet Chukchi Sea. pp. 25-31 In: Conference Proceedings, Third Information Transfer Meeting, OCS Study MMS-90, Minerals Management Service, Alaska OCS Region, 253 pp.
- Bockstoce, J.R. 1986. Whales, Ice and Men, The History of Whaling in the Western Arctic. University of Washington Press, Seattle, WA, 400 pp.
- Bockstoce, J.R. and D.B. Botkin. 1983. The historical status and reduction of the western arctic bowhead whale (Balaena mysticetus) population by the pelagic whaling industry, 1848-1914. *Rep. Int. Whal. Commn., Spec Iss.* 5: 107-141.
- Bogoslovskaya, L.S. 1986. On the social behavior of gray whales off Chukotka and Koryaka. *Rep. Int. Whal. Commn., Spec. Iss.* 8: 243-251.
- Bogoslovskaya, L.S., L.M. Votrogov, and I.I. Krupnik. 1982. The bowhead whale off Chukotka: migrations and aboriginal whaling. *Rep. Int. Whal. Commn.* 32: 391-399.
- Boucher, G.C. and C.J. Boaz. 1989. Documentation for the Marine Mammal Sightings Database of the National Marine Mammal Laboratory. NOAA Technical Memorandum NMFS F/NWC-159, 60 pp.
- Bourke, R.H. 1983. Currents, fronts and fine structure in the marginal ice zone of the Chukchi Sea. *Polar Record* 21(135): 569-575.
- Bowman, M.J. and W.E. Esaias. 1978. Oceanic fronts in coastal processes. Springer-Verlag, Berlin, 114 pp.
- Braham, H.W., B.D. Krogman and G.M. Carroll. 1984. Bowhead and white whale migration, distribution, and abundance in the Bering, Chukchi and Beaufort Sea, 1975-78. NOAA Technical Report NMFS SSRF-778, 39 pp.
- Breiwick, J.M., E.D. Mitchell and D.G. Chapman. 1981. Estimated initial population size of the Bering Sea stock of bowhead whale (Balaena mysticetus): an iterative method. *U.S. Fish. Bull.* 78 (4): 843-853.

- Breiwick, J.M., D.J. Rugh, M.E. Dahlheim and S.T. Buckland. 1988. Preliminary population estimates of gray whales during the 1987/88 southward migration. Sci. Comm. Int. Whal. Commn. unpub. paper SC/40/PS12, 21 pp.
- Brueggeman, J.J., C.I. Malme, R.A. Grotefendt, D.P. Volsen, J.J. Burns, D.G. Chapman, D.K. Ljungblad and G.A. Green. 1990. Shell Western E&P Inc. 1989 Walrus Monitoring Program: the Klondike, Burger, and Popcorn Prospects in the Chukchi Sea. Final Report by Ebasco Environmental, for Shell Western E&P, variously paginated.
- Chapman, C.F. 1971. Piloting, Seamanship and Small Boat Handling. Hearst Books, New York, 640 pp.
- Clarke, J.T. and S.E. Moore. 1989. Belukha (Delphinapterus leucas) fall distribution and migration in the Alaskan Beaufort Sea, 1982-87. p. 12, In: Abstracts, Eighth Biennial Conference on the Biology of Marine Mammals, Pacific Grove, CA, 7-11 Dec., 81 pp.
- Clarke, J.T., S.E. Moore and D.K. Ljungblad. 1989. Observations on gray whale (Eschrichtius robustus) utilization patterns in the northeastern Chukchi Sea, July-October 1982-1987. Can. J. Zool. 67: 2646-2654.
- Clarke, J.T., S.E. Moore and D.K. Ljungblad. 1987. Observations of bowhead whale (Balaena mysticetus) calves in the Alaskan Beaufort Sea during the autumn migration, 1982-85: Rep. Int. Whal. Commn. 37: 287-293.
- Cochran, W.G. 1963. Sampling Techniques. J. Wiley, New York, 413 pp.
- Cubbage, J.C. and J. Calambokidis. 1987. Size-class segregation of bowhead whales discerned through aerial stereo photogrammetry. Mar. Mamm. Sci. 3 (2): 179-185.
- Ellison, W.T., C.W. Clark and G.C. Bishop. 1987. Potential use of surface reverberation by bowhead whales, Balaena mysticetus, in under-ice navigation: preliminary considerations. Rep. int. Whal. Comm. 37: 329-332.
- Feder, H.M., A.S. Naidu, M.J. Hameedi, S.C. Jewett and W.R. Johnson. 1990. The Chukchi Sea continental shelf: benthos-environmental interactions. pp. 27-312 In: MMS/NOAA OCSEAP Final Reports of Principal Investigators, Vo. 68, 629 pp.
- Fissel, D.B., J.R. Marko, J.R. Birch, G.A. Borstad, D.N. Truax and R. Kerr. 1987. Water mass distributions. pp. 11-134, In: Importance of the eastern Alaskan Beaufort Sea to feeding bowhead whales, 1985-86, W.J. Richardson (ed.) OCS Study MMS-87-0037. Final report to the U.S. Minerals Management Service, Alaska OCS Region, prepared by LGL Ecological Research Associates, Inc., 547 pp.
- Gaskin, D.E. 1982. The Ecology of Whales and Dolphins. Heinemann Educational Books Ltd. Exeter, New Hampshire; 459 pp.

- George, J.C., C. Clark, G.M. Carroll and W.T. Ellison. 1989. Observations on the ice-breaking and ice navigation behavior of migrating bowhead whales (Balaena mysticetus) near Point Barrow, Alaska, spring 1985. *Arctic* 42(1): 24-30.
- Harwood, L.A. and J.K.B. Ford. 1983. Systematic aerial surveys of bowhead whales and other marine mammals in the southwestern Beaufort Sea, August-September 1982. Final Report to Dome Petroleum Limited, Calgary, Alberta, Canada, and Gulf Canada Resources, Inc., prepared by ESL Environmental Sciences Limited, Sidney, British Columbia. 70 pp.
- IWC. 1991. Report of the bowhead whale assessment meeting. 1991 Scientific Committee Meeting of the IWC, 28 pp.
- Johnson, W.R. 1989. Current response to wind in the Chukchi Sea: a regional coastal upwelling event. *J. Geophys. Res.* 94 (C2): 2057-2064.
- LaBelle, J.C., J.L. Wise, R.P. Volker, R.H. Schulze and G.M. Wohl. 1983. Alaska Marine Atlas. AEIDC, University of Alaska, Anchorage, AK, 302 pp.
- Ljungblad, D.K., S.E. Moore and J.T. Clarke. 1986a. Assessment of bowhead whale (Balaena mysticetus) feeding patterns in the Alaskan Beaufort and northeastern Chukchi Sea via aerial surveys, Fall 1979-84. *Rep. Int. Whal. Commn.* 36: 265-272.
- Ljungblad, D.K., S.E. Moore, J.T. Clarke and J.C. Bennett. 1988. Distribution, abundance, behavior and bioacoustics of endangered whales in the western Beaufort and northeastern Chukchi Seas, 1979-87. OCS Study MMS-87-0122, Final Report prepared for the U.S. Minerals Management Service, Alaska OCS Region, prepared by NOSC and SEACO, NOSC Tech. Rep. No. 1232, 231 pp.
- Ljungblad, D.K., S.E. Moore and D.R. Van Schoik. 1986c. Seasonal patterns of distribution, abundance, migration and behavior of the western Arctic stock of bowhead whales, Balaena mysticetus in Alaskan seas. *Rep. Int. Whal. Commn., Spec. Iss.* 8: 177-205.
- Miller, R.V., D.J. Rugh, and J.H. Johnson. 1986. The distribution of bowhead whales, Balaena mysticetus, in the Chukchi Sea. *Mar. Mamm. Sci.* 2(3): 214-222.
- Moore, S.E. and J.T. Clarke. 1991. Bowhead whale fall migration in the eastern Chukchi Sea. 1991 Scientific Committee Meeting of the IWC, Paper No. SC/43/PS2, 12 pp.
- Moore, S.E. and J.T. Clarke. 1990. Distribution, abundance and behavior of endangered whales in the Alaskan Chukchi and western Beaufort sea, 1989. OCS Study MMS 90-0051, Final Report by SEACO/SAIC for MMS, Alaska OCS Region, 240 pp.
- Moore, S.E., J.T. Clarke and D.K. Ljungblad. 1986a. A comparison of gray whale (Eschrichtius robustus) and bowhead whale (Balaena mysticetus) distribution, abundance, habitat preference and behavior in the northeastern Chukchi Sea, 1982-84. *Rep. Int. Whal. Commn.* 36: 273-279.

- Moore, S.E., D.K. Ljungblad, and D.R. Van Schoik. 1986b. Annual patterns of gray whale (*Eschrichtius robustus*) distribution, abundance and behavior in the northern Bering and eastern Chukchi Seas, July 1980-1983. Rep. Int. Whal. Commn., Spec. Iss. 8: 231-242.
- Muench, R.D., C.H. Pease and S.A. Salo. 1991 (in press). Oceanographic and meteorological effects on autumn sea ice distribution in the western Arctic. *Annals of Glaciology* 15.
- Mysak, L.A. and D.K. Manak. 1989. Arctic sea-ice extent and anomalies, 1953-1984. *Atmosphere-ocean* 27(2): 376-405.
- Nasu, K. 1974. Movement of baleen whales in-relation to hydrographic conditions in the northern part of the North Pacific Ocean and the Bering Sea. pp. 345-361 In: *Oceanography of the Bering Sea*, D.W. Hood and E.J. Kelley (eds.), Institute of Marine Sciences, University of Alaska, Fairbanks, AK, 623 pp.
- Naval Hydrographic Office. 1956. Aerial Ice Reconnaissance and Functional Glossary of Ice Terminology. Hydrographic Office Pub. No. 609, 14 pp.
- Norton, P. and L.A. Harwood. 1985. White whale use of the southeastern Beaufort Sea, July-September 1984. Canadian Technical Report of Fisheries and Aquatic Sciences 1401.
- Paquette, R.G. and R.H. Bourke. 1981. Ocean circulation and fronts as related to ice melt-back in the Chukchi Sea. *J. Geophys. Res.* 86(C5): 4215-4230.
- Parsons, T.R., M. Takahashi and B. Hargrave. 1977. Biological oceanographic processes, 2nd. edition. Pergamon Press, Oxford, UK, 332 pp.
- Reilly, S.B. and V.G. Thayer. 1990. Blue whale (*Balaenoptera musculus*) distribution in the eastern tropical Pacific. *Mar. Mamm. Sci.* 6(4): 265-277.
- Richardson, W.J. (ed.). 1987. Importance of the eastern Alaskan Beaufort Sea to feeding bowhead whales, 1985-86. OCS Study MMS-87-0037. Final Report for the U.S. Minerals Management Service, Alaska OCS Region, prepared by LGL Ecological Research Associates, Inc., 547 pp.
- Rugh, D.J. and M.A. Fraker. 1981. Gray whale (*Eschrichtius robustus*) sightings in the eastern Beaufort Sea. *Arctic* 34(2): 186-187.
- Stringer, W.J. and J.E. Groves. 1987. Summertime sea ice intrusions in the Chukchi Sea. OCS Env. Assess. Program: Chukchi Sea Update, June 1987: 33-41.
- Treacy, S.D. 1990. Aerial surveys of endangered whales in the Beaufort Sea, Fall 1989. OCS Study MMS 90-0047, MMS Alaska OCS Region, 69 pp. + appendices.
- Treacy, S.D. 1991. Aerial surveys of endangered whales in the Beaufort Sea, Fall 1990. OCS Study MMS 91-00xx, MMS Alaska OCS Region, in prep.

Wartzok, D. 1990. Industry-sponsored bowhead whale monitoring and research in the U.S. and Canadian Beaufort Sea. pp. 33-40 In Conference Proceedings, Third Information Transfer Meeting, MMS, Alaska OCS Region, OCS Study MMS 90-0041, 253 pp.

Wursig, B., C.W. Clark, E.M. Dorsey, W.J. Richardson and R.S. Wells. 1983. Normal behavior of bowheads, 1982. pp. 25-115 In Behavior, disturbance responses and distribution of bowhead whales Balaena mysticetus in the eastern Beaufort Sea, 1982. W.J. Richardson (ed.) Final Report prepared for U.S. Minerals Management Service, Alaska OCS Region, prepared by LGL Ecology Research Assoc. Inc. Bryan TX, 357 pp.

Zar, S.H. 1984. Biostatistical Analysis. Prentice Hall, Inc. Englewood Cliffs, N.J. 620 pp.

APPENDIX A

**AERIAL SURVEY FLIGHT CAPTIONS, SURVEY
TRACKS, AND SIGHTING SUMMARIES, 1990**

CONTENTS

	Page
INTRODUCTION	A-1
SUMMARY TABLES AND FLIGHT TRACKS	
Table A-1. Summary of daily flight effort in the Chukchi Sea, 1990	A-4
Table A-2. Summary of daily marine mammal sightings by species, 1990	A-5
Flight Captions, Survey Tracks and Sighting Summaries	A-6
OCTOBER	
1-10: Flights 1 to 2	A-6
11-20: Flights 3 to 13	A-8
21-31: Flights 14 to 20	A-19
NOVEMBER	
1-3: Flights 21 to 26	A-26

INTRODUCTION

This appendix consists of flight tracks 1 through 26, depicting aerial surveys flown over the Chukchi Sea from early October through early November 1990. Maps were generated by AutoCAD using a map digitized by the United States Geological Survey (Bauer 1989). Each map shows the flight track as a line drawn through position updates and/or sighting locations, as recorded on the aircraft computer system. Each symbol on the flight track/sighting charts represents one sighting of one or more animals. A caption describing the flight's objectives, survey conditions and sightings accompanies each map. Additionally, summary information on bowhead and gray whale sightings is presented beneath the flight caption in the tabularized format:

T#/C#	Total number of whales/total number of calves seen
LAT/LONG	Location (latitude N/longitude W) in degrees, minutes, and tenths of minutes
DIS	Perpendicular distance from the aircraft in meters (altitude x cotangent clinometer angle)
CUE	Sighting cue: BO = Body MP = Mud Plumes BW = Blow DY = Display SP = Splash IT = Ice Track
BEH	Behavior: SW = Swim DY = Display SH = Spyhop DI = Dive MT = Mate TS = Tail-Slap RE = Rest FE = Feed BR = Breach MI = Mill CC = Cow-Calf RL = Roll UB = Underwater DE = Dead NA = None Blow
HDG	Heading in degrees, magnetic
ICE	Ice cover in percent
SS	Sea State (Beaufort scale)
DEPTH	Depth in meters

Dashes (-) indicate data were not recorded.

This page intentionally left blank

Summaries of daily flight effort (Table A-1) and marine mammal sightings (Table A-2) precede the flight tracks and provide an overview of survey effort and sighting data for the 1990 field season. Species abbreviations and symbols used in Table A-2 and on the flight tracks are as follows:

- BH = Bowhead Whale
- GW = Gray Whale
- △ BE = Belukha
- ▽ CT = Unidentified Cetacean
- ◇ WS = Walrus
- ☆ BS = Bearded Seal
- ⊗ RS = Ringed Seal
- * PN = Unidentified Pinniped
- ⊗ PR = Polar Bear

Table A-1. Summary of daily flight effort, 1990. *Search and rescue (SAR) flights.

Date	Flt No.	Transect (km)	Connect (km)	Search (km)	Total (km)	Transect Time (h)	Total Time (h)
3 Oct	1	174	25	112	310	0.75	1.18
9 Oct	2	162	17	19	199	0.63	0.79
11 Oct	3	386	86	94	565	1.49	2.42
13 Oct*	4	0	0	1247	1247	0.00	4.97
14 Oct*	5	0	0	83	83	0.00	0.31
14 Oct*	6	0	0	1577	1577	0.00	6.01
15 Oct*	7	0	0	1411	1411	0.00	5.47
16 Oct*	8	0	0	1237	1237	0.00	4.50
16 Oct*	9	0	0	891	891	0.00	3.83
17 Oct*	10	0	0	882	882	0.00	3.35
18 Oct*	11	0	0	1469	1469	0.00	5.31
19 Oct*	12	0	0	1411	1411	0.00	5.36
19 Oct*	13	0	0	268	268	0.00	1.09
21 Oct*	14	0	0	549	549	0.00	2.92
22 Oct*	15	0	0	682	682	0.00	3.57
26 Oct	16	398	22	182	600	1.57	2.44
28 Oct	17	261	12	13	287	1.07	1.18
29 Oct	18	633	101	251	985	2.40	3.78
30 Oct	19	640	52	391	1085	2.48	4.24
31 Oct	20	776	97	252	1125	3.01	4.36
1 Nov	21	1193	132	374	1700	4.81	6.80
2 Nov	22	93	0	268	361	0.30	1.40
4 Nov	23	438	0	473	911	1.70	3.57
5 Nov	24	26	0	408	434	0.15	1.83
6 Nov	25	645	102	168	915	2.65	3.77
7 Nov	26	304	18	44	365	1.27	1.52
Total		6,129	664	14,756	21,549	24.28	85.97

Table A-2. Summary of daily marine mammal sightings by species, 1990. Number of sightings/number of animals.

Date	Flt No.	BH	GW	CT	BE	WS	BS	RS	PN	PB
3 Oct	1	0	0	0	2/4	0	0	0	0	0
9 Oct	2	2/2	0	0	0	0	0	0	1/2	0
11 Oct	3	3/5	1/1	0	3/7	0	0	0	4/5	0
13 Oct	4	0	0	0	9/13	0	0	0	1/1	0
14 Oct	5	1/1	0	0	0	0	0	0	2/2	0
14 Oct	6	2/5	0	0	18/38	141/1037	0	0	8/15	1/1
15 Oct	7	1/1	0	1/1	6/9	1/2	5/5	0	3/4	8/8
16 Oct	8	1/1	0	0	4/4	1/4	2/3	0	15/16	9/12
16 Oct	9	0	0	0	0	0	2/2	0	40/56	8/11
17 Oct	10	0	0	0	0	0	1/2	0	7/11	1/3
18 Oct	11	0	0	0	1/2	0	1/1	0	2/2	3/4
19 Oct	12	0	0	0	0	0	0	0	0	0
19 Oct	13	0	0	0	0	0	0	0	0	0
21 Oct	14	2/2	0	0	0	0	0	1/1	1/1	0
22 Oct	15	0	0	0	2/4	3/43	0	0	0	2/2
26 Oct	16	0	0	0	0	0	0	0	0	1/1
28 Oct	17	0	0	0	0	0	0	0	2/6	0
29 Oct	18	2/2	0	0	9/18	5/11	0	0	3/3	0
30 Oct	19	0	0	0	0	25/211	4/4	0	9/11	2/2
31 Oct	20	0	0	0	0	2/11	1/1	2/2	12/18	0
1 Nov	21	0	0	0	0	0	4/4	0	14/14	6/9
2 Nov	22	0	0	0	0	0	0	0	0	0
4 Nov	23	0	0	0	6/11	0	0	0	4/4	0
5 Nov	24	0	0	0	0	0	0	0	1/1	0
6 Nov	25	0	0	0	0	0	0	0	0	0
7 Nov	26	0	0	0	0	0	0	0	3/3	0
Total		14/19	1/1	1/1	60/110	178/1319	20/22	3/3	132/186	41/53

Flight 1: 3 October 1990

Flight was a transect survey of the central portion of block 12, with a search survey nearshore in block 12. Weather was mostly overcast with some precipitation and fog. Visibility varied from zero to 10 km. Sea state was Beaufort 05-06. Four belukhas were seen.

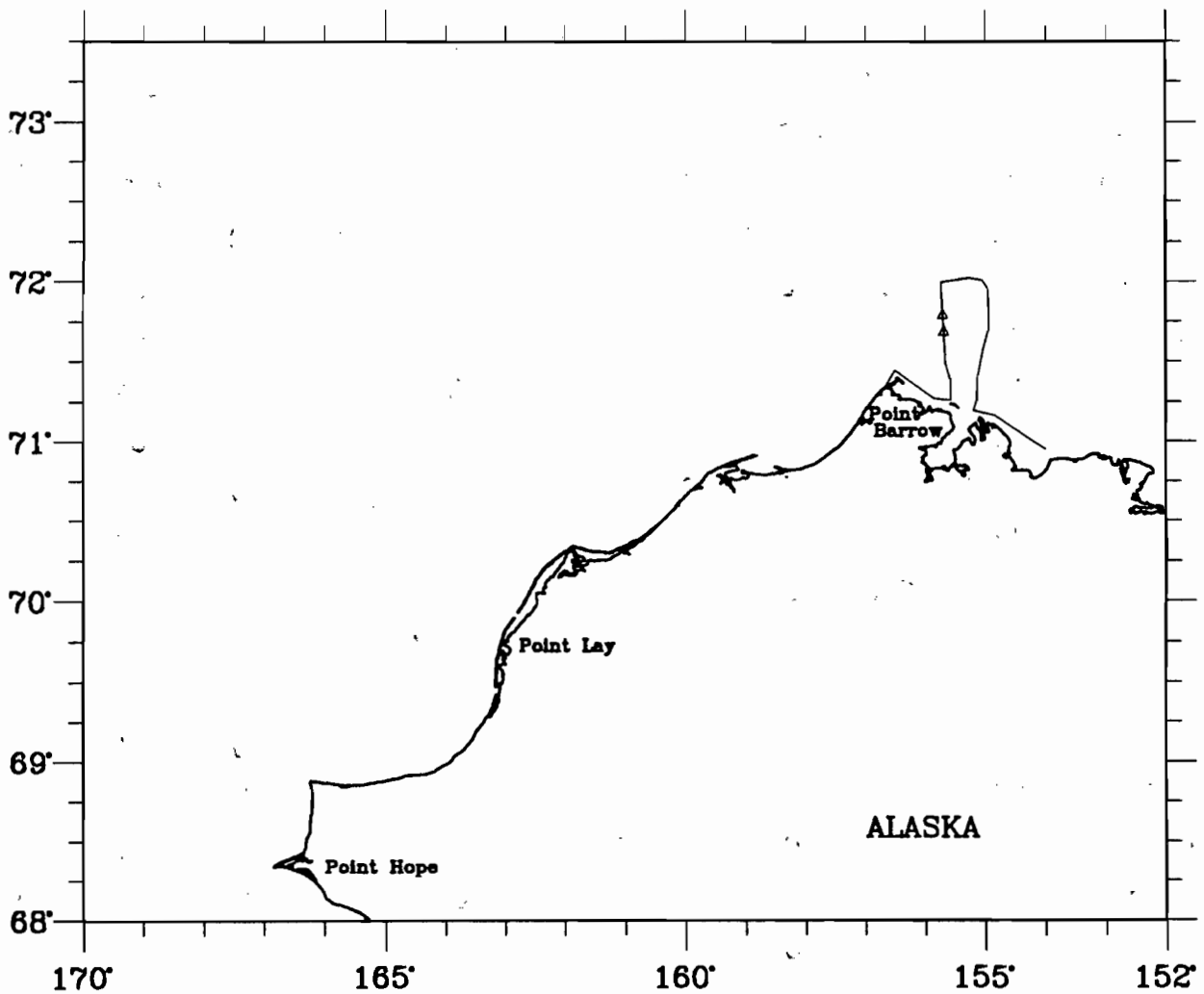

Flight 2: 9 October 1990

Flight was a transect survey in the eastern one-third of block 12. Weather was overcast with some fog and visibility varied from zero to 5 km. Sea state was Beaufort 02-04. Two bowheads were seen swimming slowly.

Bowhead Whales

T#/C#	LAT(N)	LONG(W)	DIS(M)	CUE	BEH	HDG	ICE	SS	DEPTH
1/0	71°18.1	154°32.4	1664	SP	SW	250	0	B2	18
1/0	71°20.2	154°33.8	799	SP	SW	210	0	B2	18

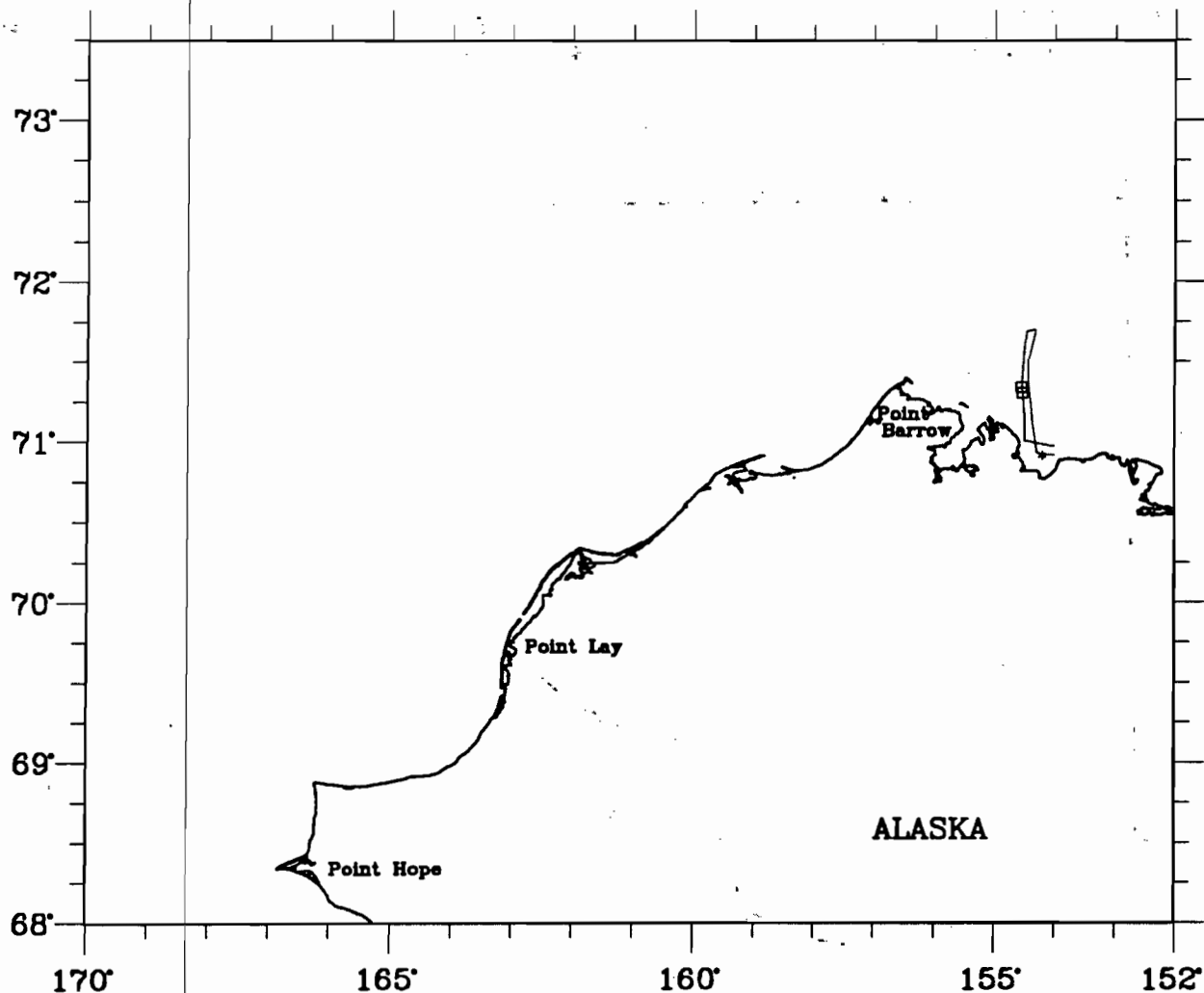

Flight 3: 11 October 1990

Flight was a transect survey of portions of blocks 12 and 13. Weather was high overcast with unlimited visibility. Sea state was Beaufort 01-02. Five bowheads were seen, including two under pursuit by Barrow whalers. A single gray whale, belukhas and unidentified pinnipeds were also seen.

Bowhead Whales

T#/C#	LAT(N)	LONG(W)	DIS(M)	CUE	BEH	HDG	ICE	SS	DEPTH
1/0	71°40.4	157°11.9	5062	BL	SW	270	0	B2	65
2/0	71°39.3	156°47.0	2339	BL	SW	270	0	B2	102
2/0	71°37.7	156°06.6	2675	BL	-	-	0	B2	122

Gray Whales

T#/C#	LAT(N)	LONG(W)	DIS(M)	CUE	BEH	HDG	ICE	SS	DEPTH
1/0	71°09.1	157°05.5	-	BO	RE	280	0	B1	19

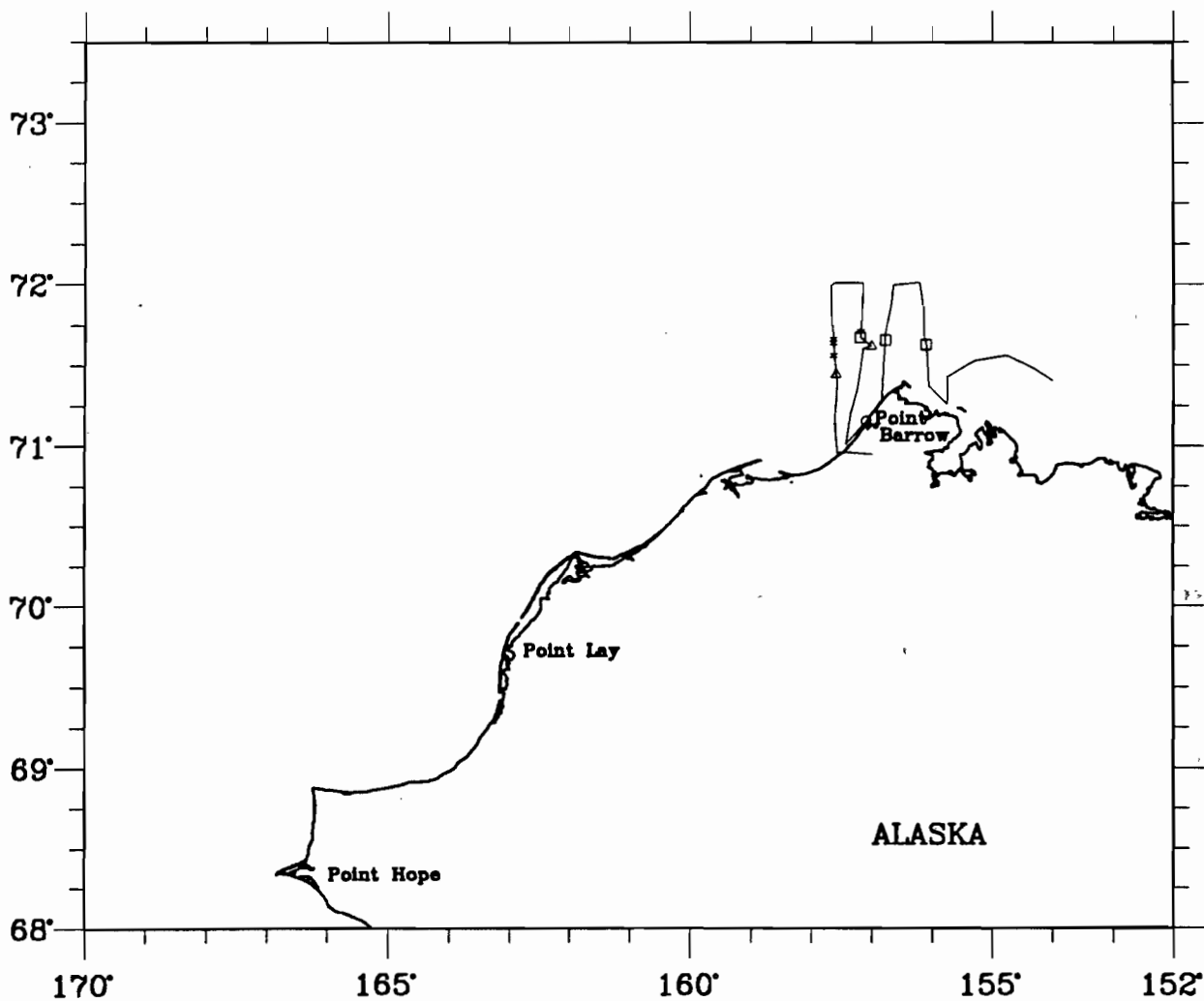

Flight 4: 13 October 1990

Flight was a search and rescue (SAR) survey in parts of blocks 12 and 12N. Weather was low overcast with visibility ranging from 5 km to unlimited. Sea state was Beaufort 04-05. One bowhead was seen just to the east of the study area in block 3 (MMS BWASP survey flight #24). Belukhas and unidentified pinnipeds were also seen.

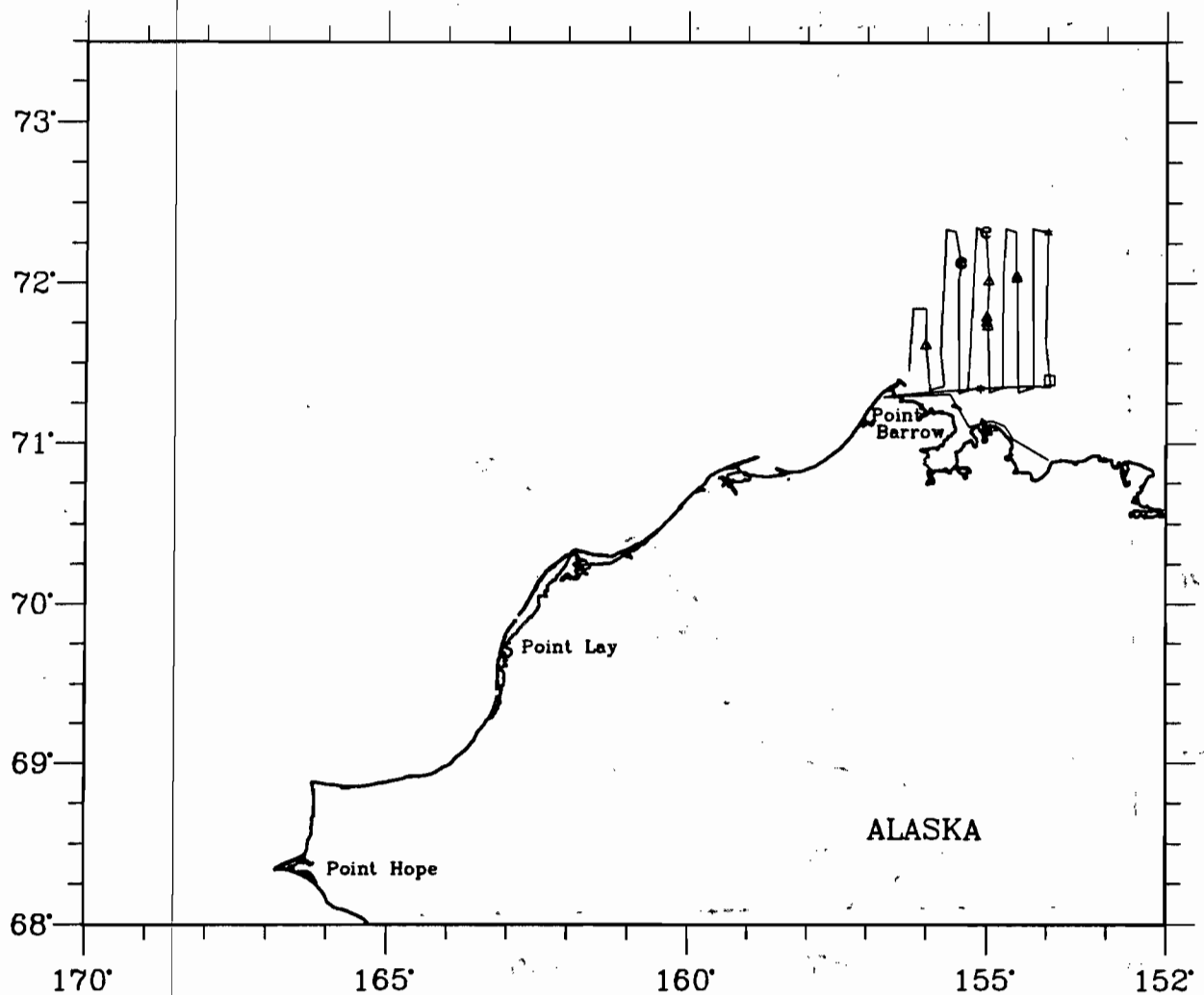

Flight 5: 14 October 1990

Flight was a search and rescue (SAR) survey through block 12. Weather was low-lying fog and icing conditions right down to the sea surface. Visibility ranged from zero to 5 km. One bowhead was seen swimming west. Unidentified pinnipeds were also seen.

Bowhead Whales

T#/C#	LAT(N)	LONG(W)	DIS(M)	CUE	BEH	HDG	ICE	SS	DEPTH
1/0	71°22.8	154°21.4	52	SP	SW	240	0	B1	26

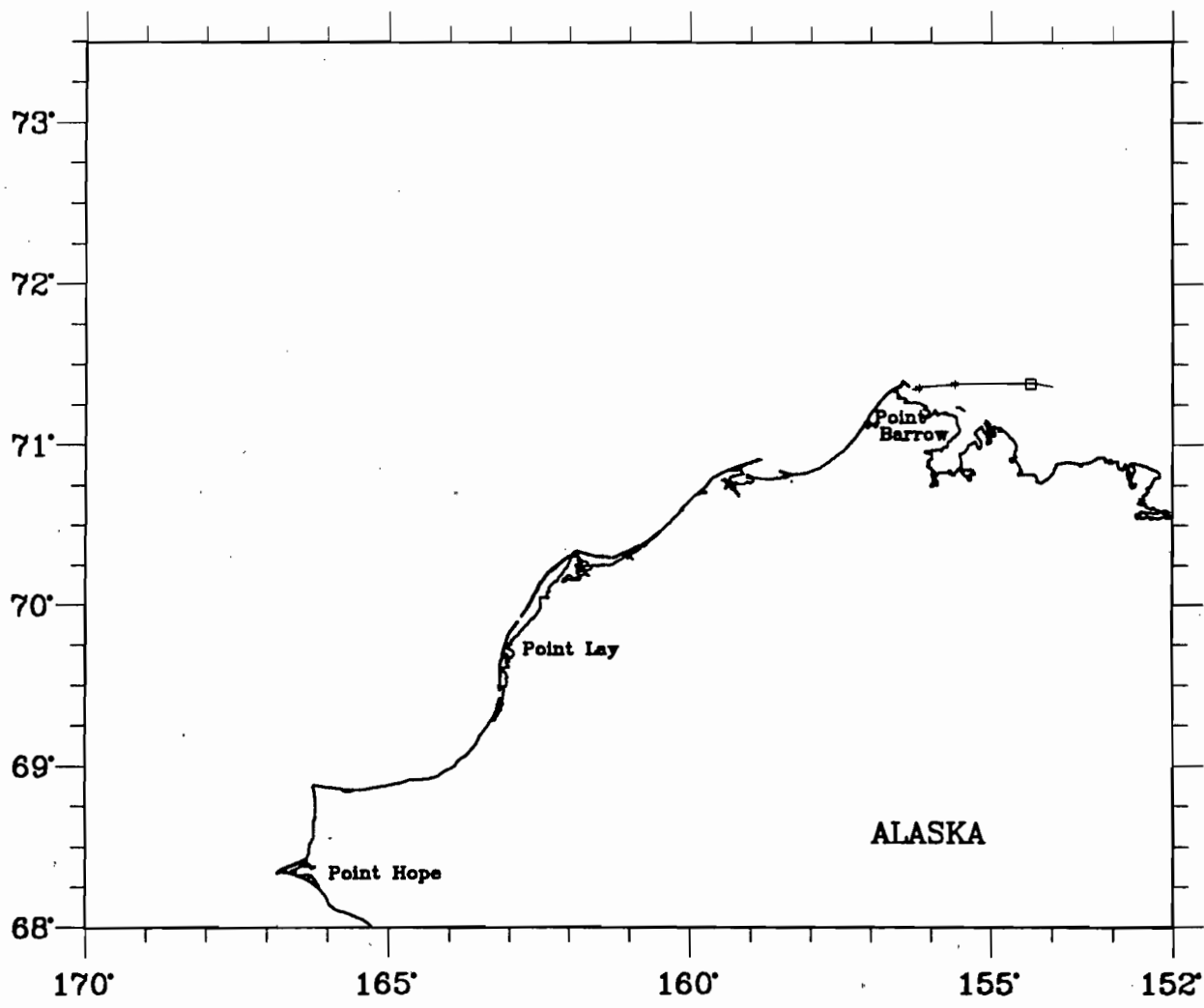

Flight 6: 14 October 1990

Flight was a search and rescue (SAR) survey in parts of, and north of, block 14N. Weather was partly cloudy with areas of low overcast and fog. Visibility ranged from < 1 km to unlimited. Sea state was Beaufort 00-04. Five bowhead whales were seen, including two cow/calf pairs, just north of block 14N. Belukhas, walrus and unidentified pinnipeds were also seen.

Bowhead Whales

T#/C#	LAT(N)	LONG(W)	DIS(M)	CUE	BEH	HDG	ICE	SS	DEPTH
4/2	73°01.9	161°01.9	-	BO	MI	150	0	B2	93
1/0	73°01.9	161°01.9	-	BO	SL	-	0	B2	93

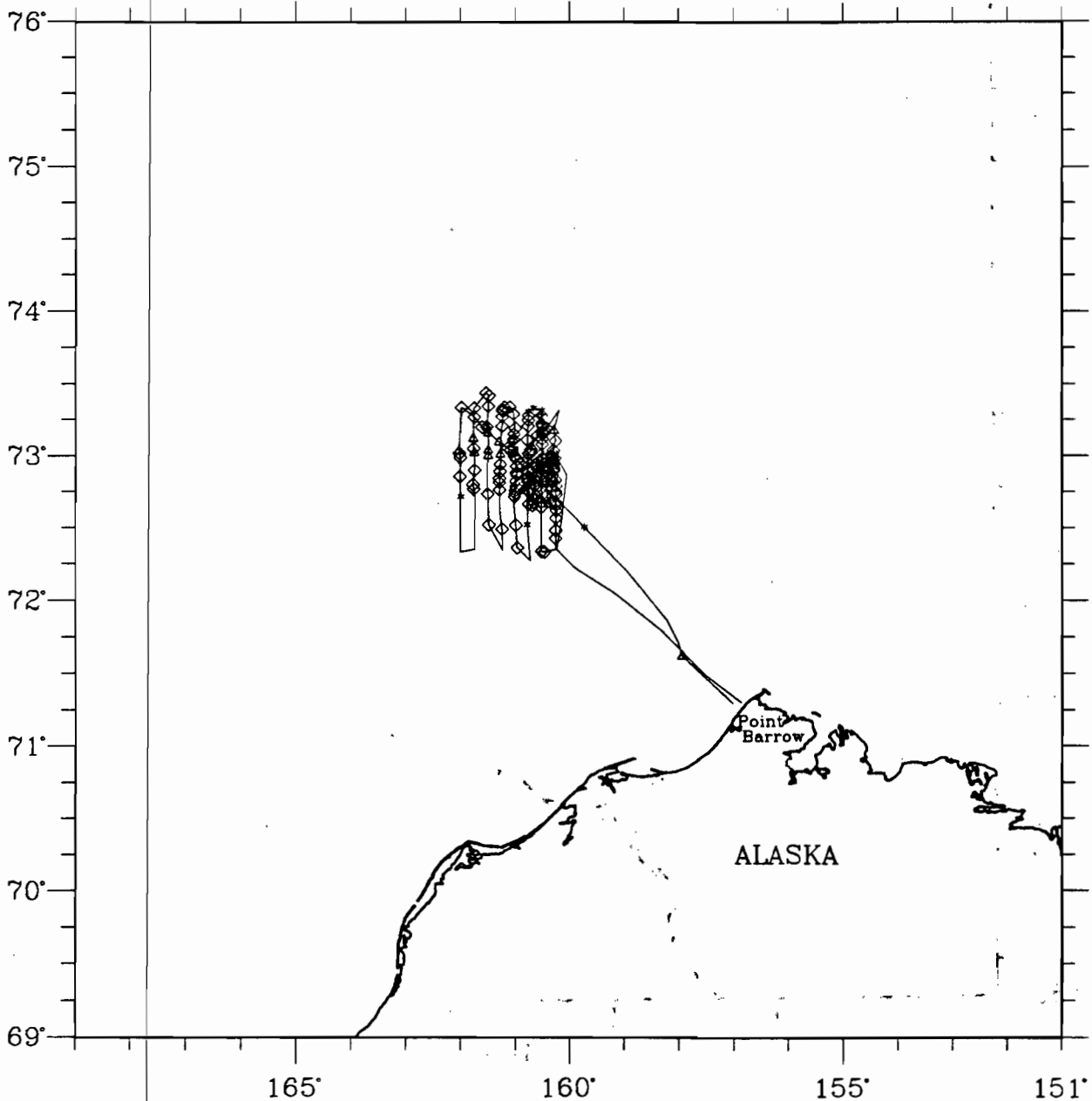

Flight 7: 15 October 1990

Flight was a search and rescue (SAR) survey north of blocks 13N and 14N. Weather was overcast with areas of fog, and visibility ranged from <1km to unlimited. Sea state was Beaufort 00-03. One bowhead whale was seen northwest of Barrow in open water. An unidentified cetacean, belukhas, bearded seals, unidentified pinnipeds and polar bears were also seen.

Bowhead Whales

T#/C#	LAT(N)	LONG(W)	DIS(M)	CUE	BEH	HDG	ICE	SS	DEPTH
1/0	71°33.8	157°32.6	284	BO	SW	210	0	B2	70

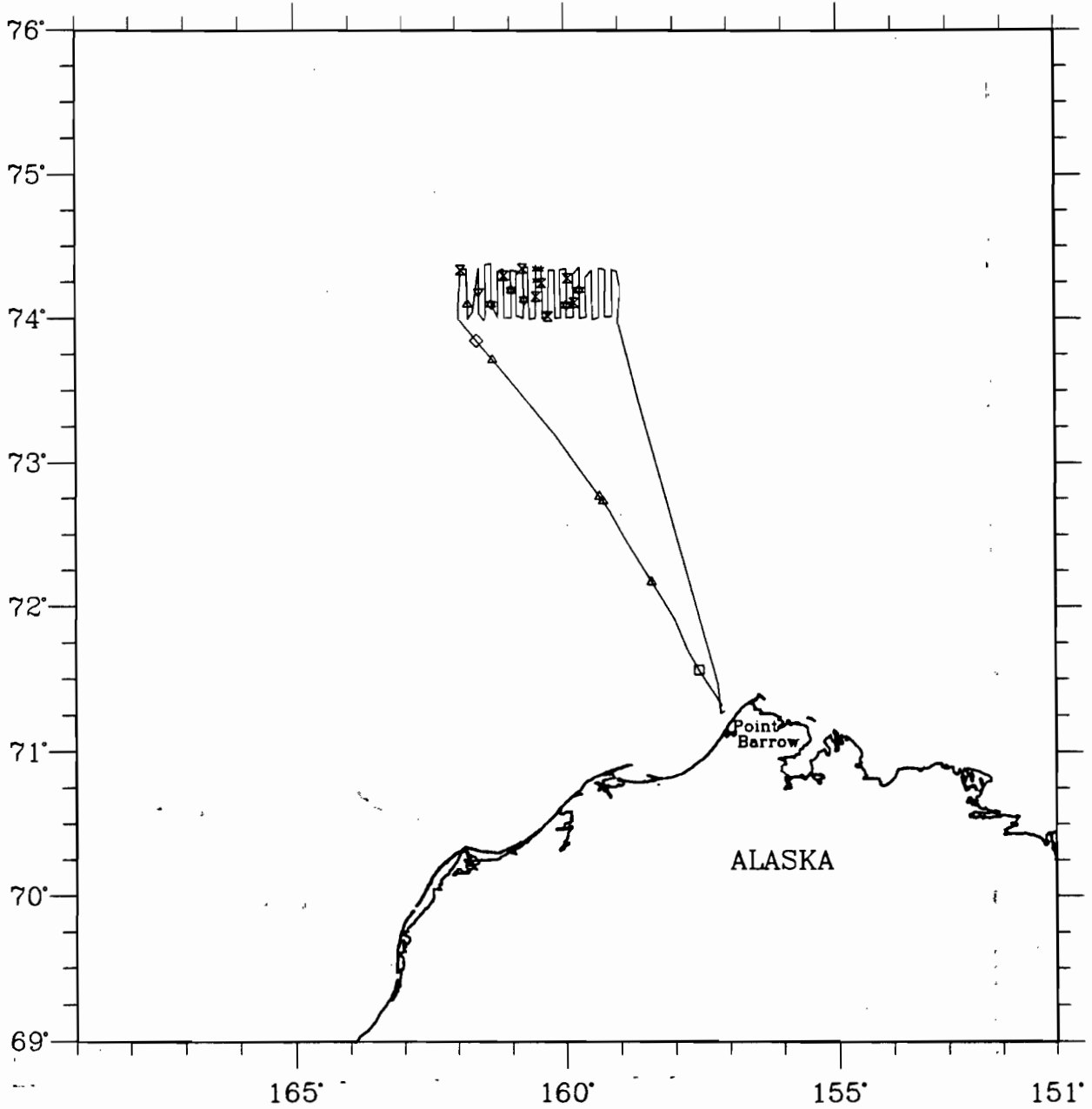

Flight 8: 16 October 1990

Flight was a search and rescue (SAR) survey north of block 13N. Weather was overcast with areas of fog, and visibility ranged from <1km to unlimited. Sea state was Beaufort 00-04. One bowhead whale was seen northwest of Barrow in open water. Belukhas, bearded seals, unidentified pinnipeds and polar bears were also seen.

Bowhead Whales

T#/C#	LAT(N)	LONG(W)	DIS(M)	CUE	BEH	HDG	ICE	SS	DEPTH
1/0	71°43.4	157°17.6	-	SP	SW	250	0	B2	56

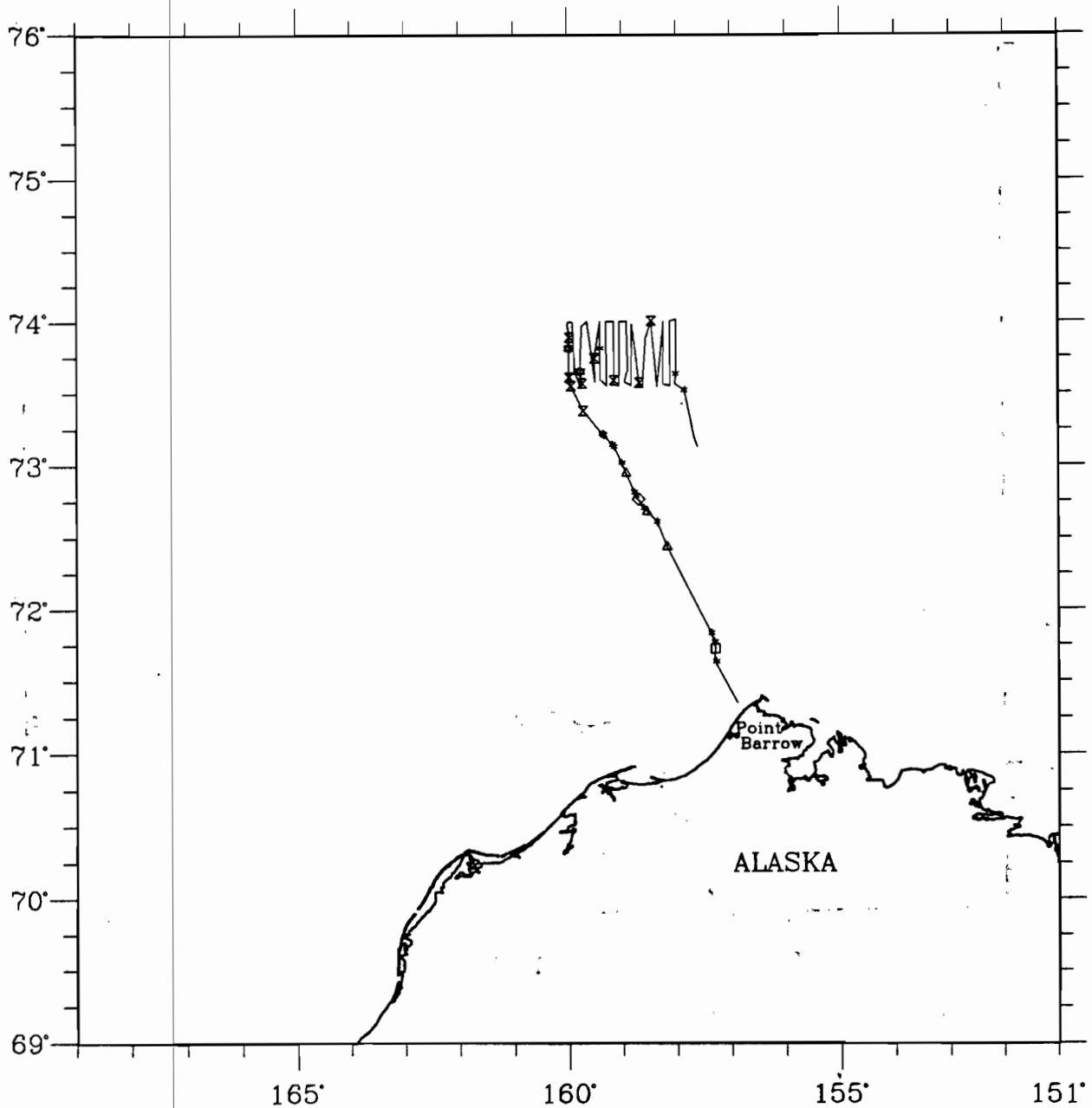

Flight 9: 16 October 1990

Flight was a search and rescue (SAR) survey north of block 12N. Weather was partly cloudy with areas of low overcast and fog. Visibility ranged from <1 km to unlimited. Sea state was Beaufort 00-02. Bearded seals, unidentified pinnipeds and polar bears were seen.

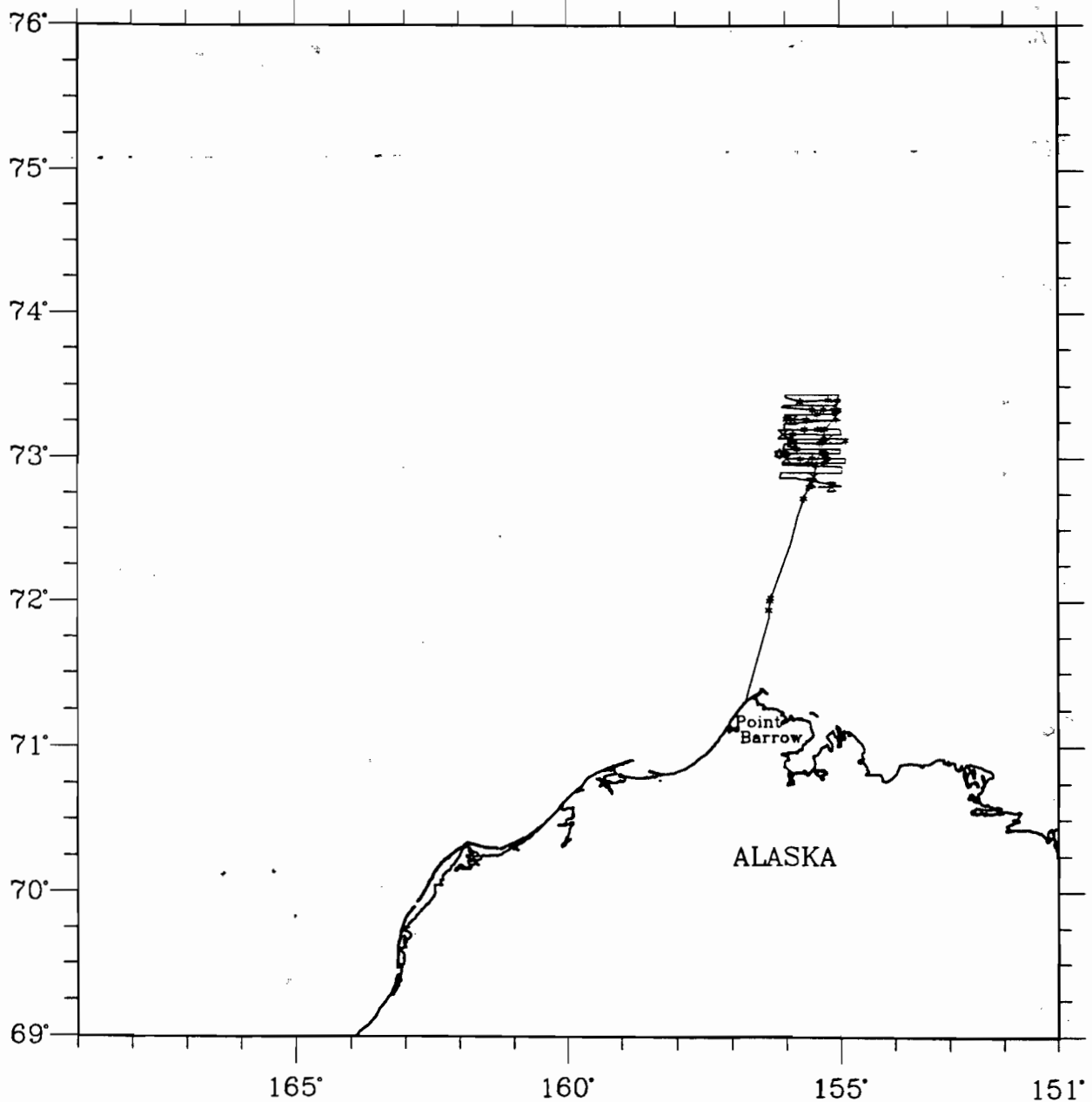

Flight 10: 17 October 1990

Flight was a search and rescue (SAR) survey north of blocks 12N and 13N. Weather was overcast with patches of fog and visibility ranged from <1km to unlimited. Sea state was Beaufort 00-01. Bearded seals, unidentified pinnipeds and polar bears were seen.

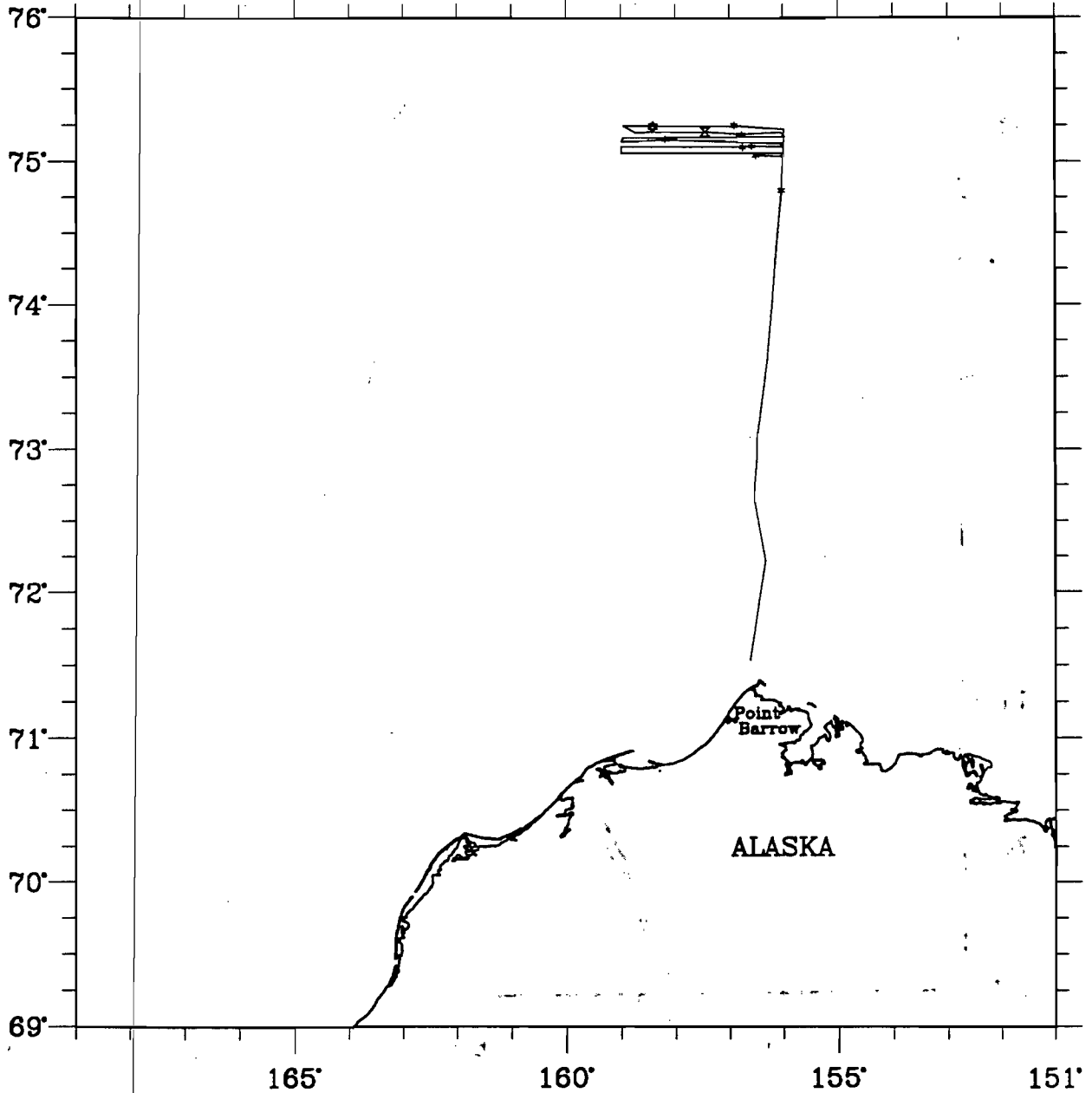

Flight 11: 18 October 1990

Flight was a search and rescue (SAR) survey north of block 13N. Weather was partly cloudy with areas of low overcast and fog. Visibility ranged from <1 km to unlimited. Sea state was Beaufort 00-02. Belukhas, bearded seals, unidentified pinnipeds and polar bears were seen.

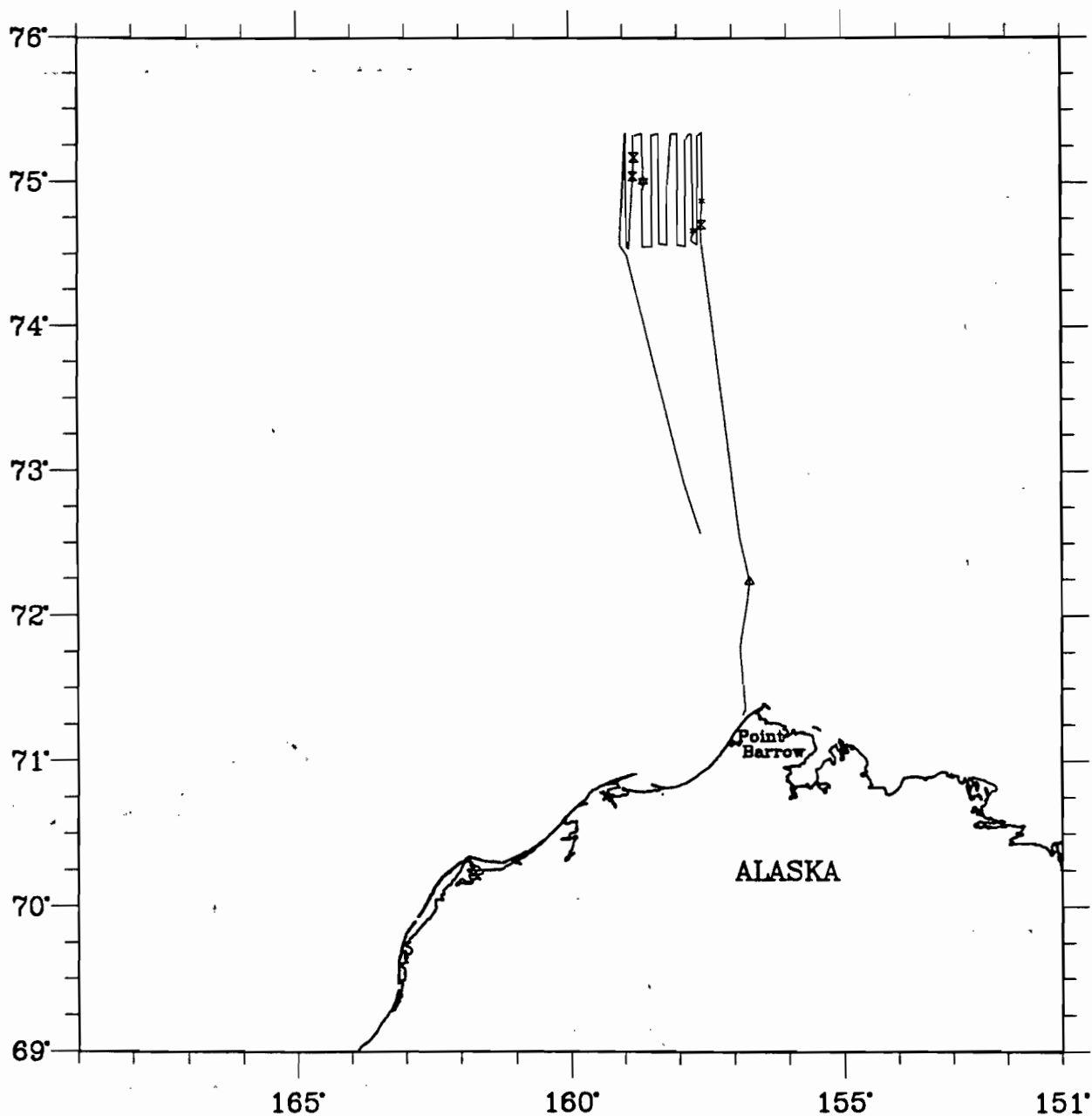

Flight 12: 19 October 1990

Flight was a search and rescue (SAR) survey northeast of block 12N. Weather was clear over the ice far offshore, with low fog obscuring visibility on a search through 12N. Visibility ranged from <1km to unlimited. Sea state was Beaufort 00-03. A bearded seal and two unidentified pinnipeds were seen.

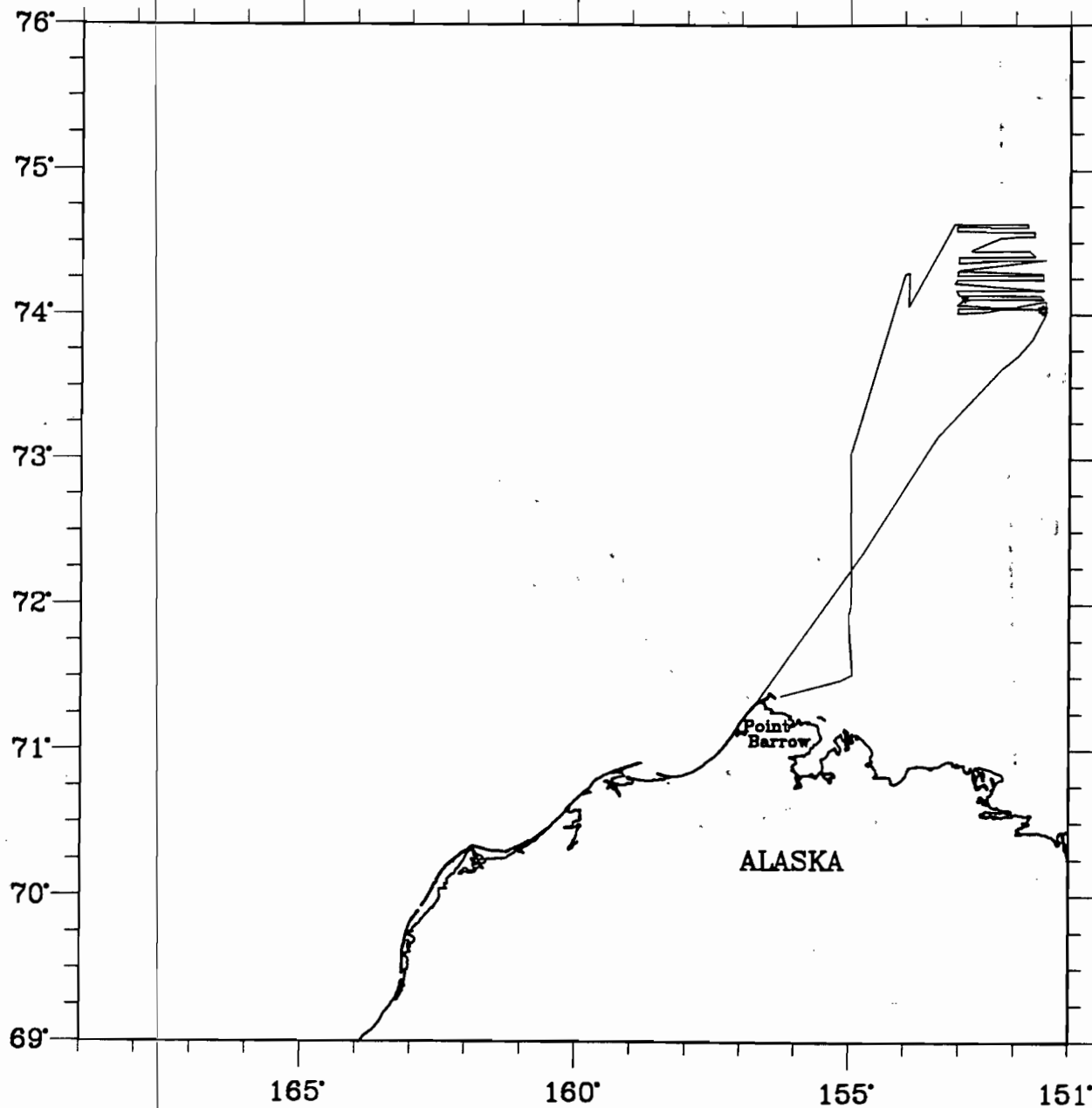

Flight 13: 19 October 1990

Flight was a search and rescue (SAR) survey in block 12. Weather was mostly overcast with some fog. Visibility varied from < 1 km to unlimited. Sea state was Beaufort 02-04.

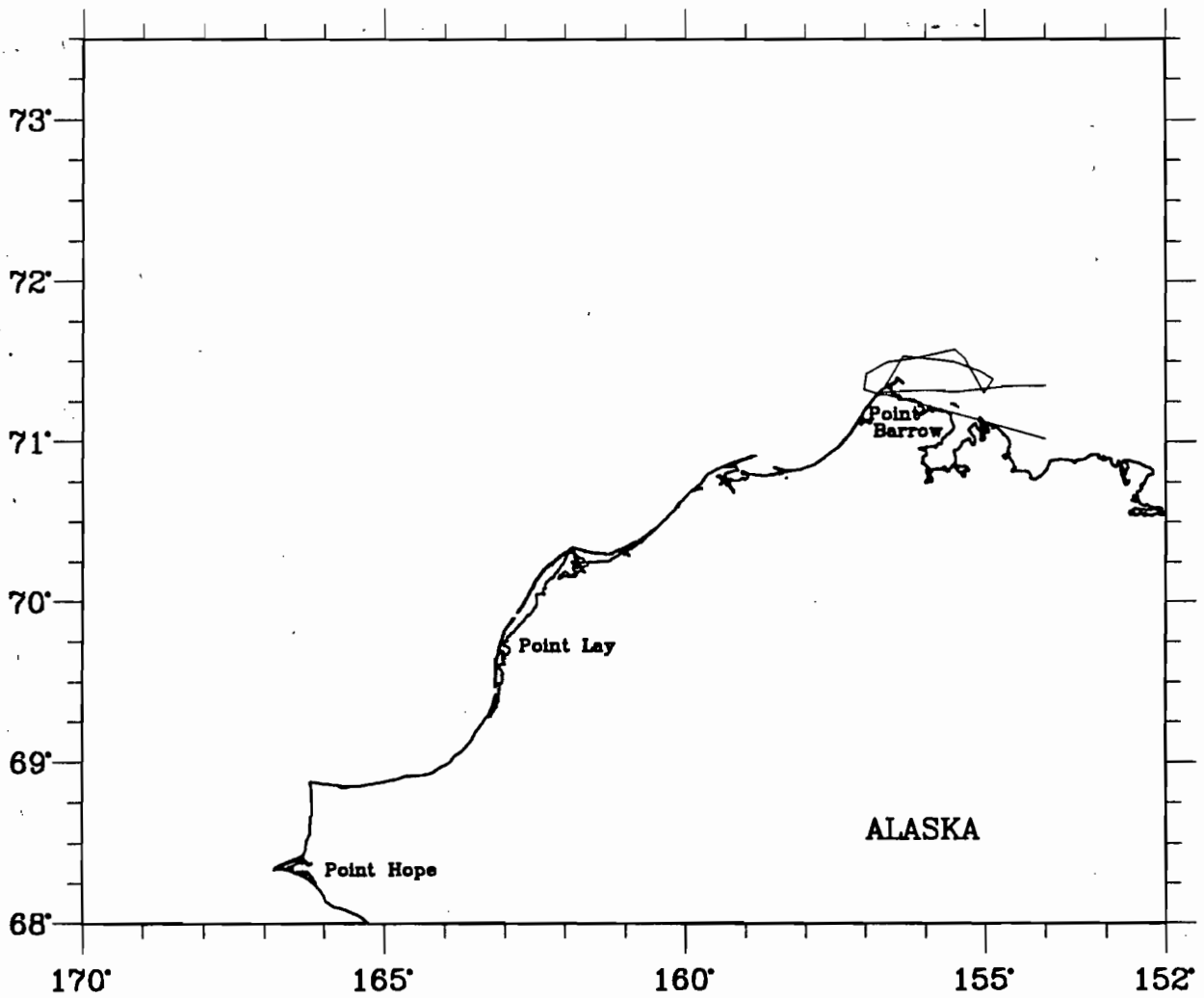

Flight 14: 21 October 1990

Flight was a search and rescue (SAR) survey north of block 14N. Weather was clear over the ice, but low fog obscured search efforts through blocks 13 and 14. Visibility ranged from <1km to unlimited. Sea state was Beaufort 01-03. Two bowheads were seen in block 13 enroute to landing after the search. One ringed seal and one unidentified pinniped were also seen.

Bowhead Whales

T#/C#	LAT(N)	LONG(W)	DIS(M)	CUE	BEH	HDG	ICE	SS	DEPTH
1/0	71°31.0	157°20.6	850	SP	SW	150	0	B3	85
1/0	71°26.6	157°15.8	219	BO	SW	210	0	B3	117

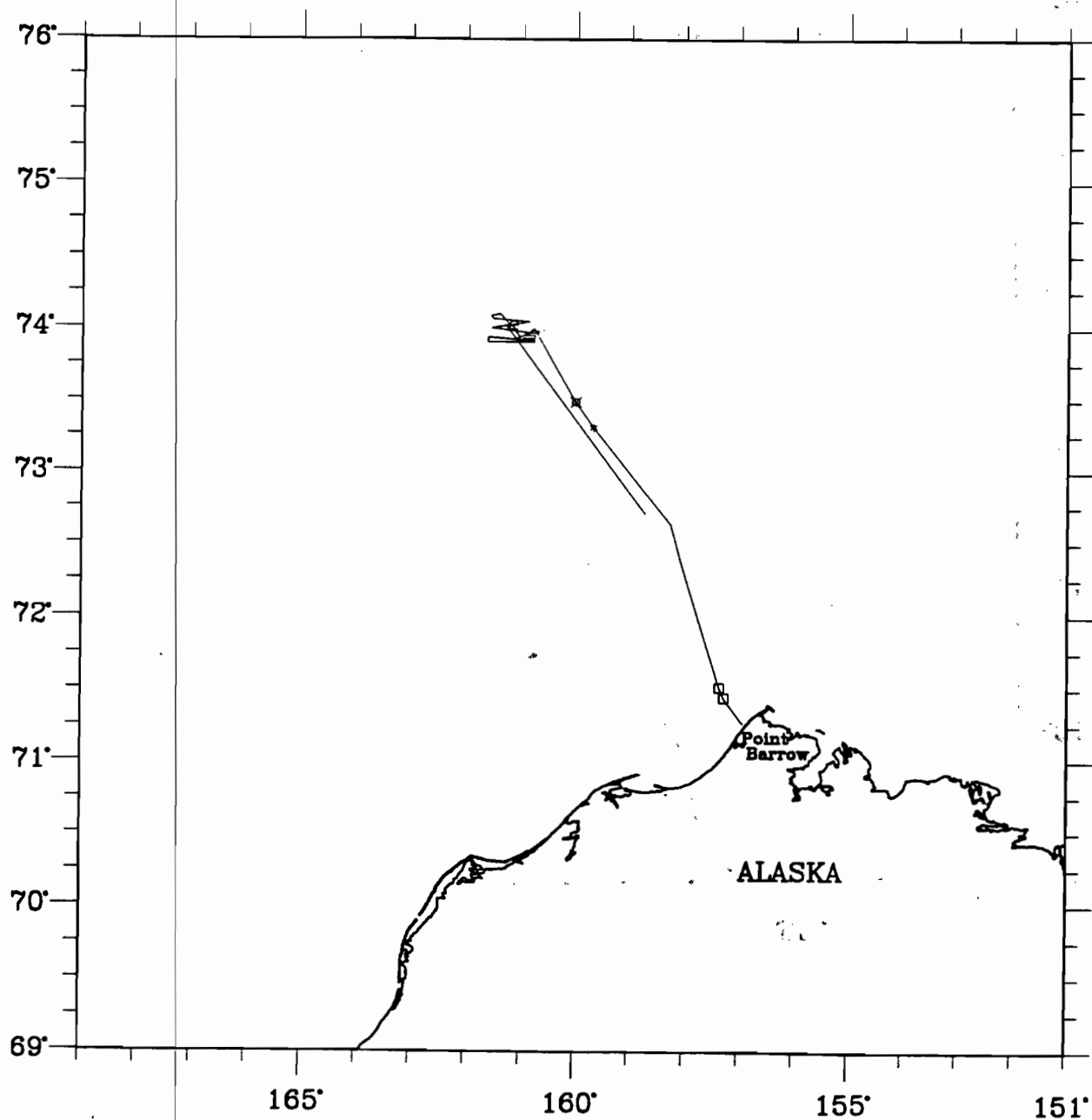

Flight 15: 22 October 1990

Flight was a search and rescue (SAR) survey north of block 15N. Weather was clear over the ice, with low overcast and some fog between Barrow and the search area. Visibility ranged from <1 km to unlimited. Sea state was Beaufort 00-03. Belukhas, walrus and polar bears were seen.

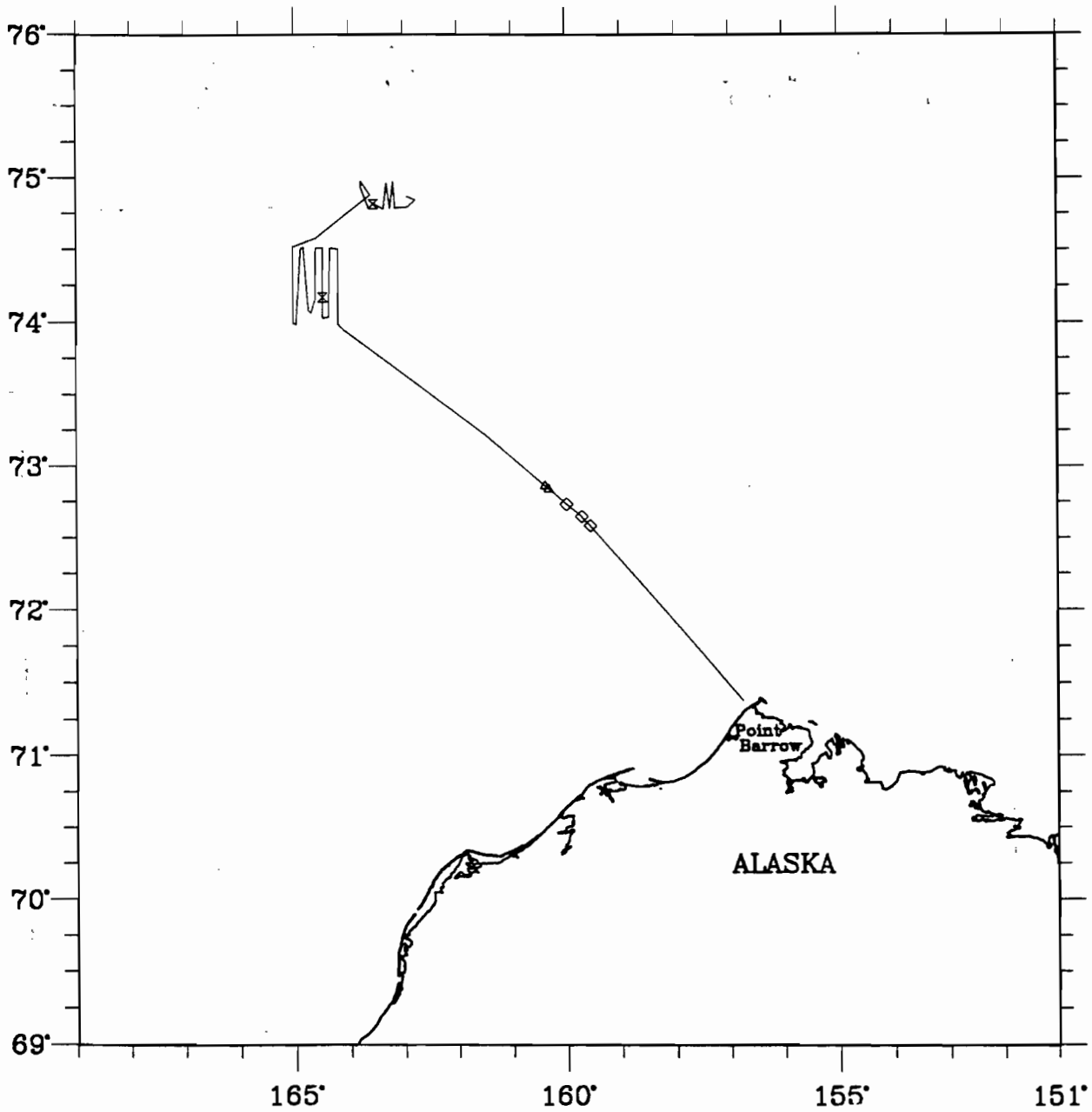

Flight 16: 26 October 1990

Flight was a transect survey in the western one-third of blocks 13 and 13N that was curtailed due to generator failure in the left engine of the aircraft. Weather was overcast in 13N but low fog in block 13. There was 90-95% new ice and broken floe ice cover in the northern half of block 13N, with 50% ice cover in the southern half and no ice in block 13. Visibility ranged from <1 km to unlimited. Sea state was Beaufort 01-07. One polar bear was seen.

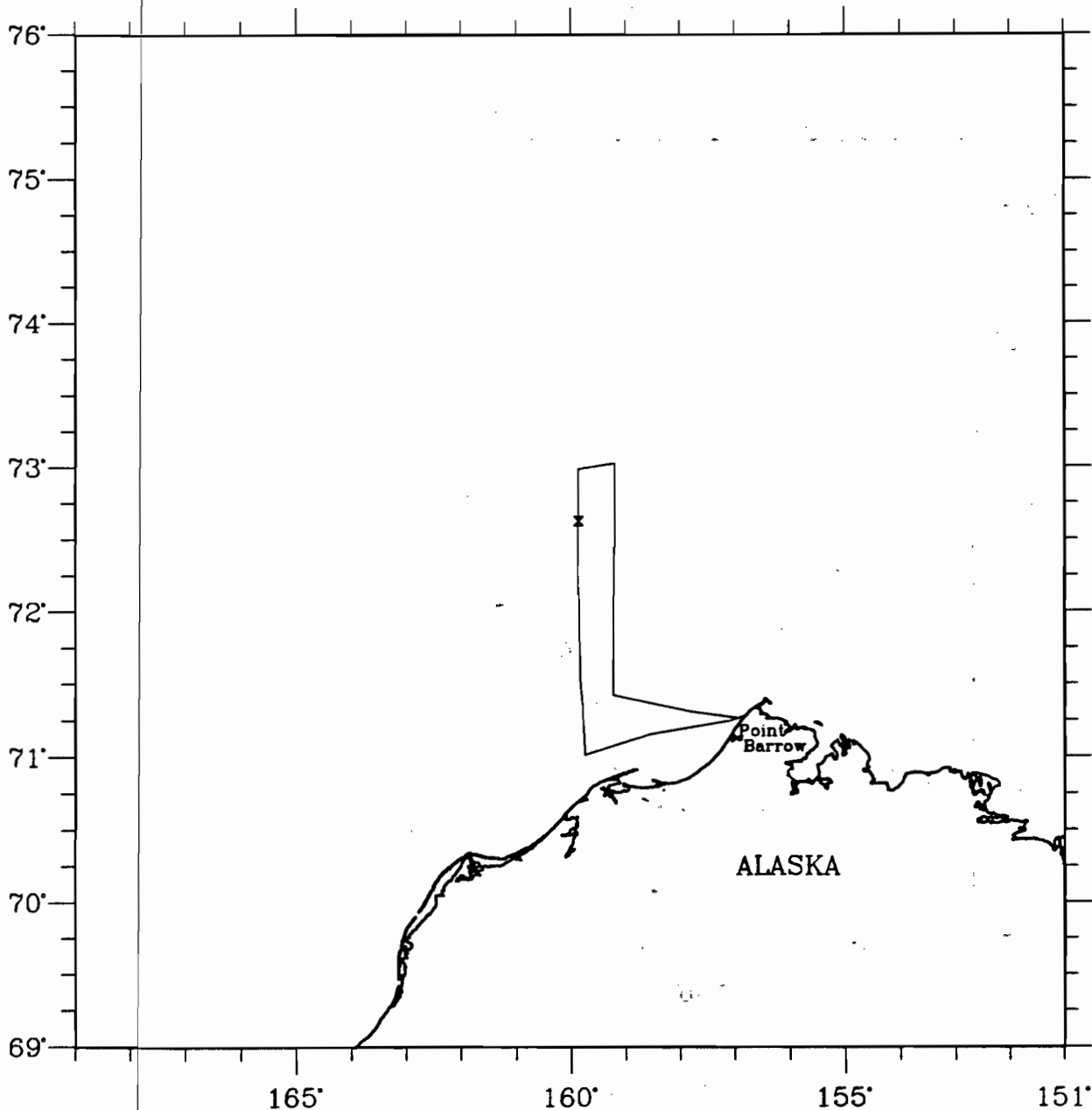

Flight 17: 28 October 1990

Flight was a transect survey in the eastern one-third of blocks 13 and 13N conducted following the repair of the survey aircraft earlier in the day. Weather was overcast and visibility ranged from roughly 2 to 10 km. There was 70-95% new ice and broken floe ice cover over most of blocks 13 and 13N. Sea state was Beaufort 00-02. Six unidentified pinnipeds were seen.

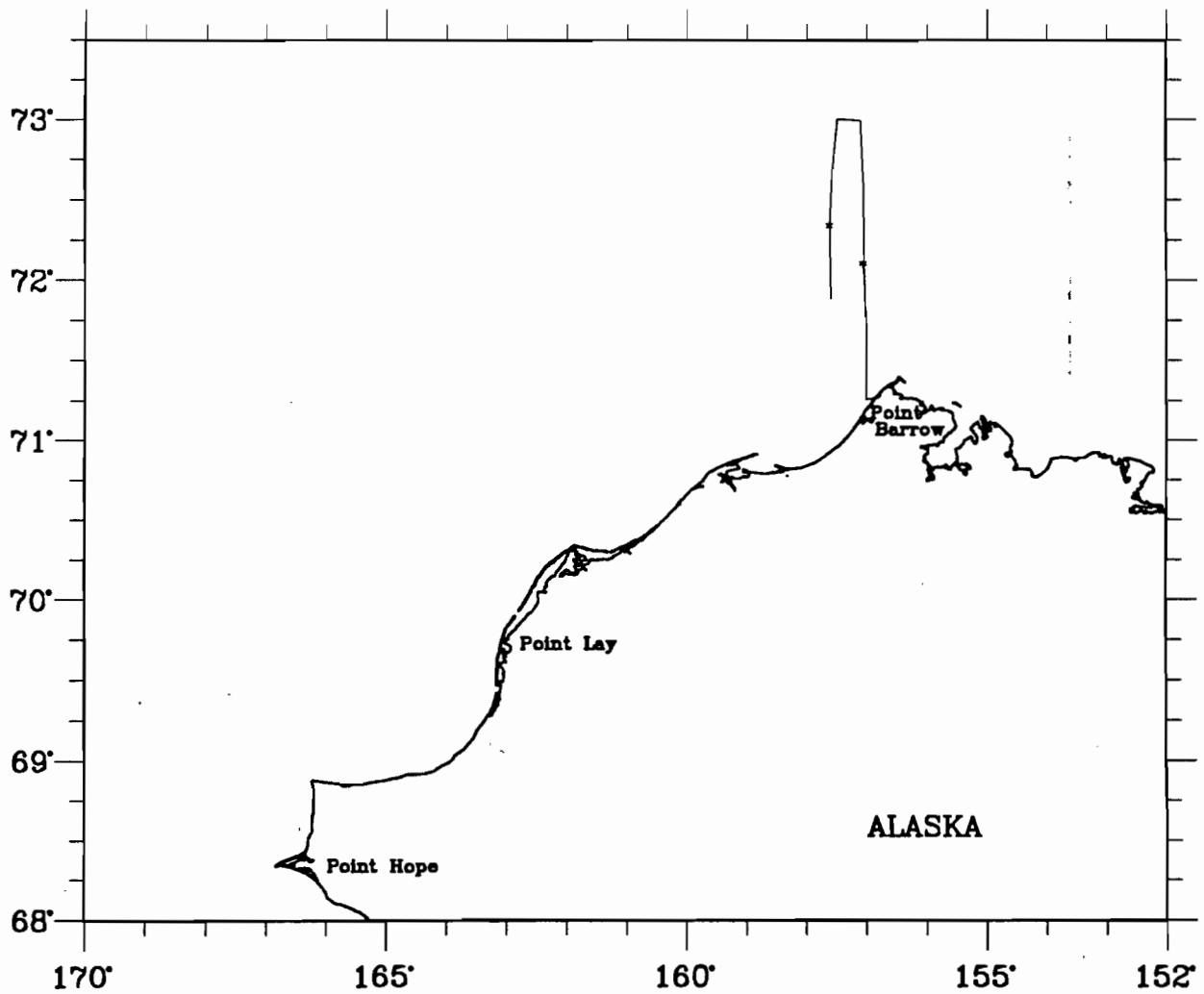

Flight 18: 29 October 1990

Flight was a transect survey in block 15N after an attempt to survey block 16N was curtailed due to extensive low fog. Weather was overcast, with areas of low fog. Visibility ranged from unacceptable to unlimited, but averaged 2 to 10 km. There was 75-90% new ice and broken floe ice cover over most of block 15N, with the ice edge farther to the north east of there. Sea state was Beaufort 00-03. Two bowheads were seen in block 15N swimming slowly southwest. Belukhas, walrus and unidentified pinnipeds were also seen.

Bowhead Whales

T#/C#	LAT(N)	LONG(W)	DIS(M)	CUE	BEH	HDG	ICE	SS	DEPTH
1/0	72°09.3	165°32.1	428	SP	SW	230	95	B0	46
1/0	72°19.0	165°36.0	347	BO	DI	210	70	B0	46

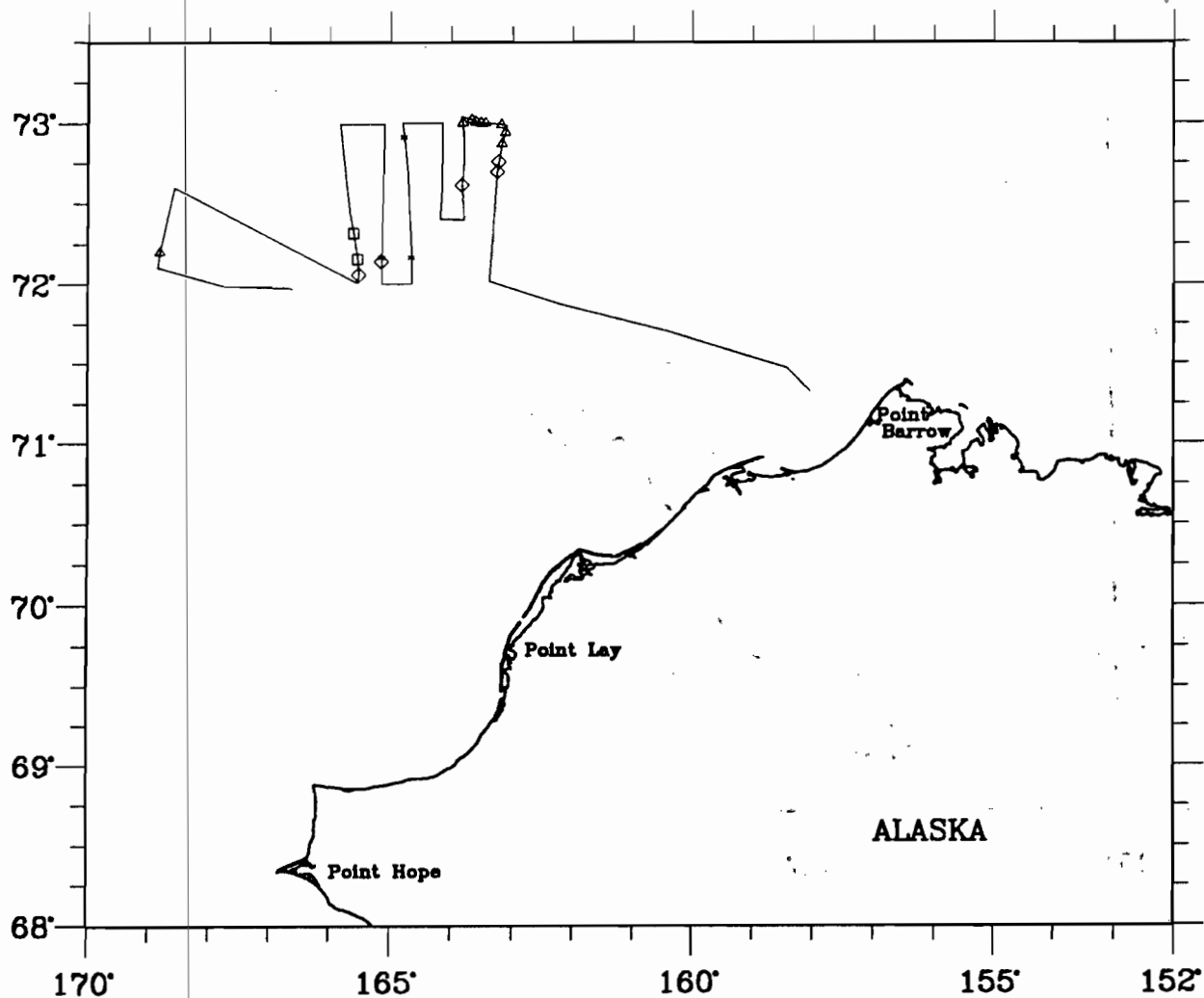

Flight 19: 30 October 1990

Flight was a transect survey in block 14N after attempts to survey portions of 12N and 13N were abandoned due to fog. Weather was partly cloudy or overcast, with areas of patchy fog. Visibility ranged from < 1 km to unlimited. Ice conditions were heavy (95%) only in the northernmost portion of the block, with the remainder of the block largely ice-free. Sea state was Beaufort 00-02. Walrus, bearded seals, unidentified pinnipeds and polar bears were seen.

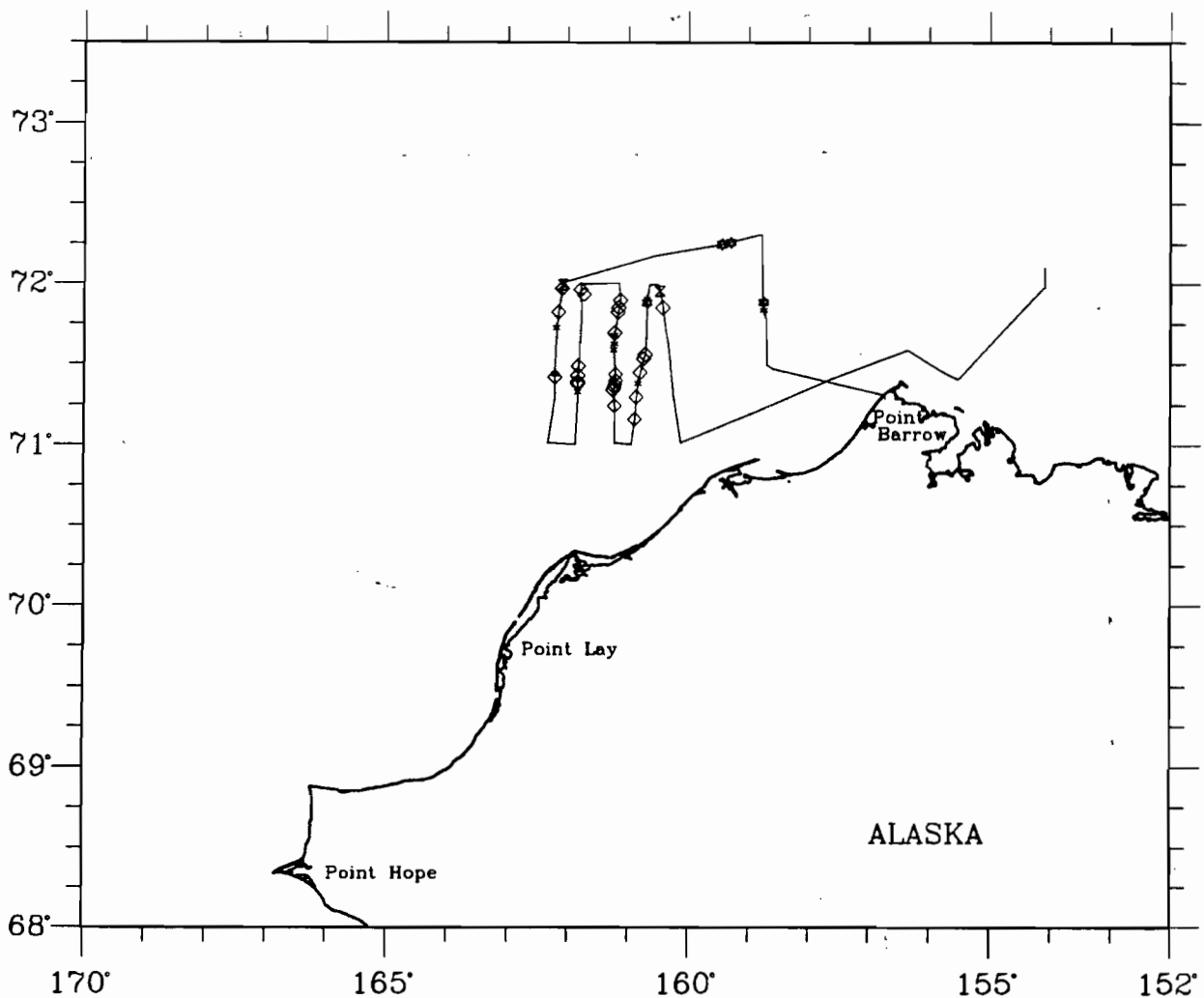

Flight 20: 31 October 1990

Flight was a partial transect survey in block 15 that was truncated due to fog and high seas, with a continued transect survey in the western two-thirds of block 14N. Weather was partly cloudy, with areas of overcast and fog. Visibility ranged from <1 km to unlimited. Block 15 was largely ice-free, while ice conditions in block 14N ranged from 80 to 99 percent. Sea state was Beaufort 00-05. Walrus, ringed seals, a bearded seal and unidentified pinnipeds were seen.

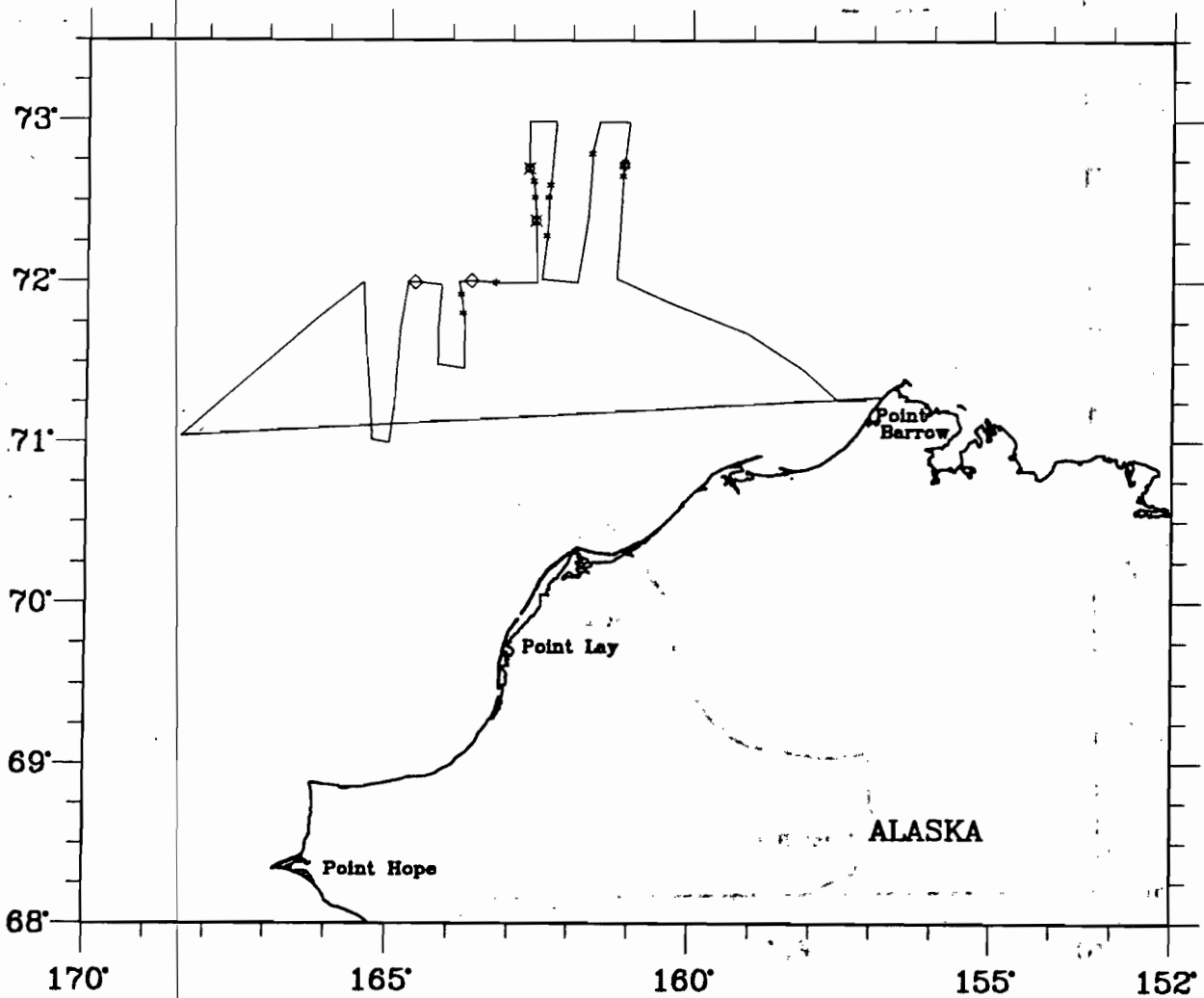

Flight 21: 1 November 1990

Flight was a transect survey in portions of blocks 14N, 13N and 12, and all of block 12N. Weather was high overcast with patches of fog in northern block 12N. Visibility ranged from <1 km to unlimited. Ice cover ranged from 80 to 99 percent and sea state was Beaufort 00-01. Bearded seals, unidentified pinnipeds and polar bears were seen.

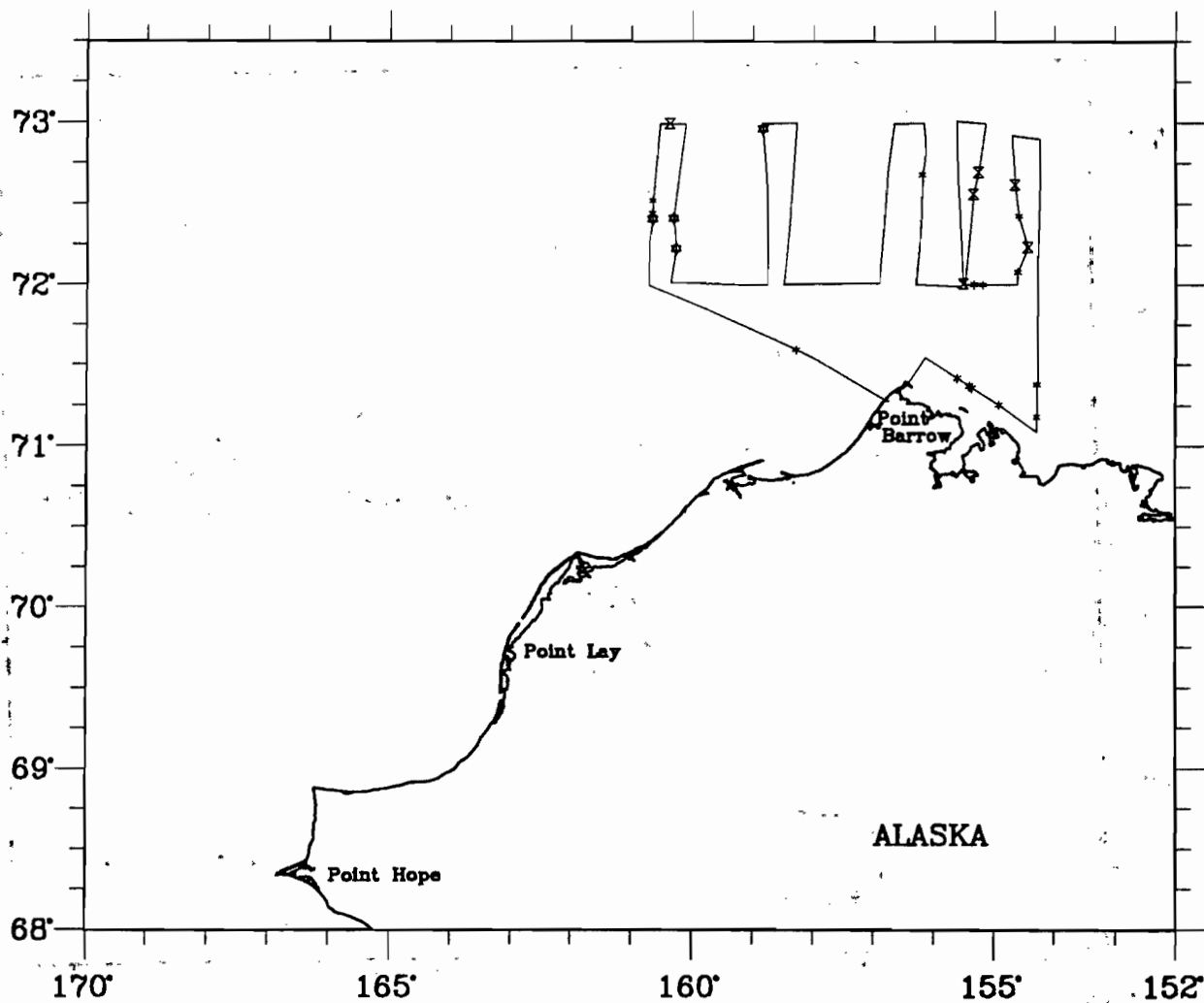

Flight 22: 2 November 1990

Flight was a partial transect survey in block 13 after survey efforts in blocks 17 and 18 were canceled due to high winds and an approaching storm. Weather was overcast with fog and visibility ranged from < 1 to 10 km. There was no ice except a ca. 1 km band of 90 percent grease ice along the coast near Barrow. Sea state was Beaufort 02-06.

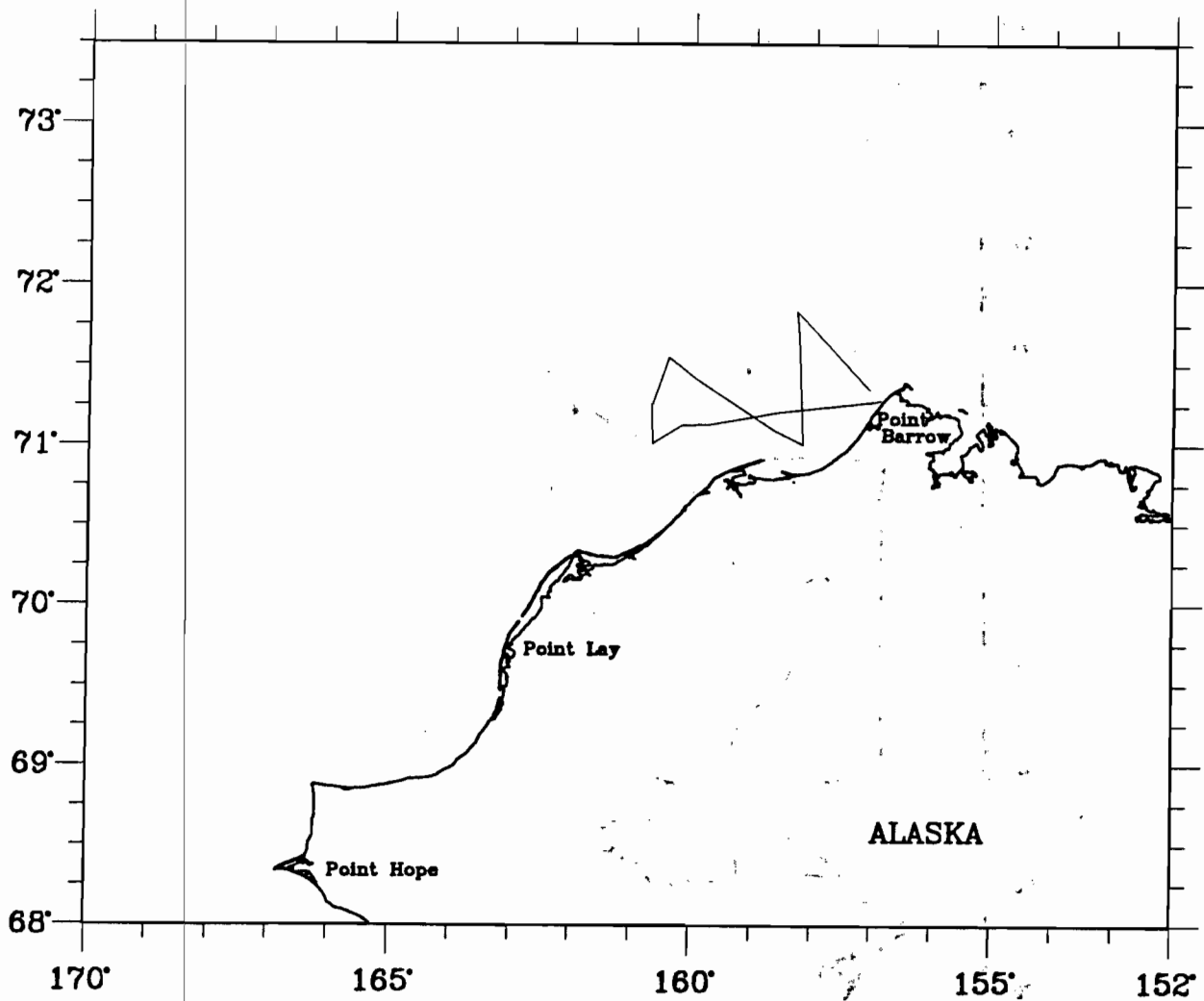

Flight 23: 4 November 1990

Flight was a partial transect survey through blocks 18, 21, 22 and 23 enroute to Kotzebue. Weather was overcast with patches of fog and snow squalls. Sea state was Beaufort 02-07. Belukhas and unidentified pinnipeds were seen.

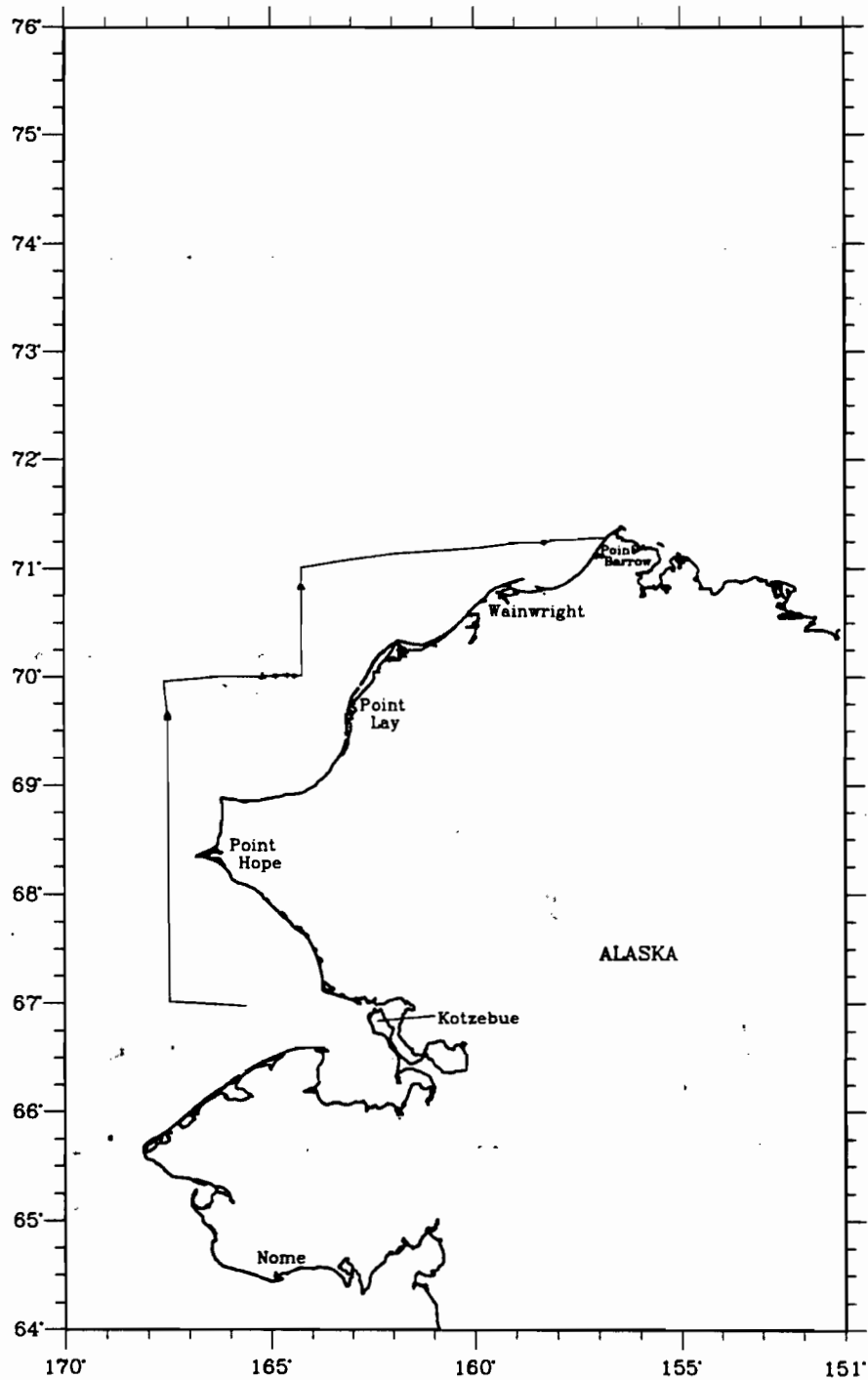

Flight 24: 5 November 1990

Flight was a transect survey in block 30 that was canceled due to extremely high sea states. Weather was mostly fog with visibility ranging from < 1 km to 5 km. Sea state ranged from Beaufort 02-08. One unidentified pinniped was seen.

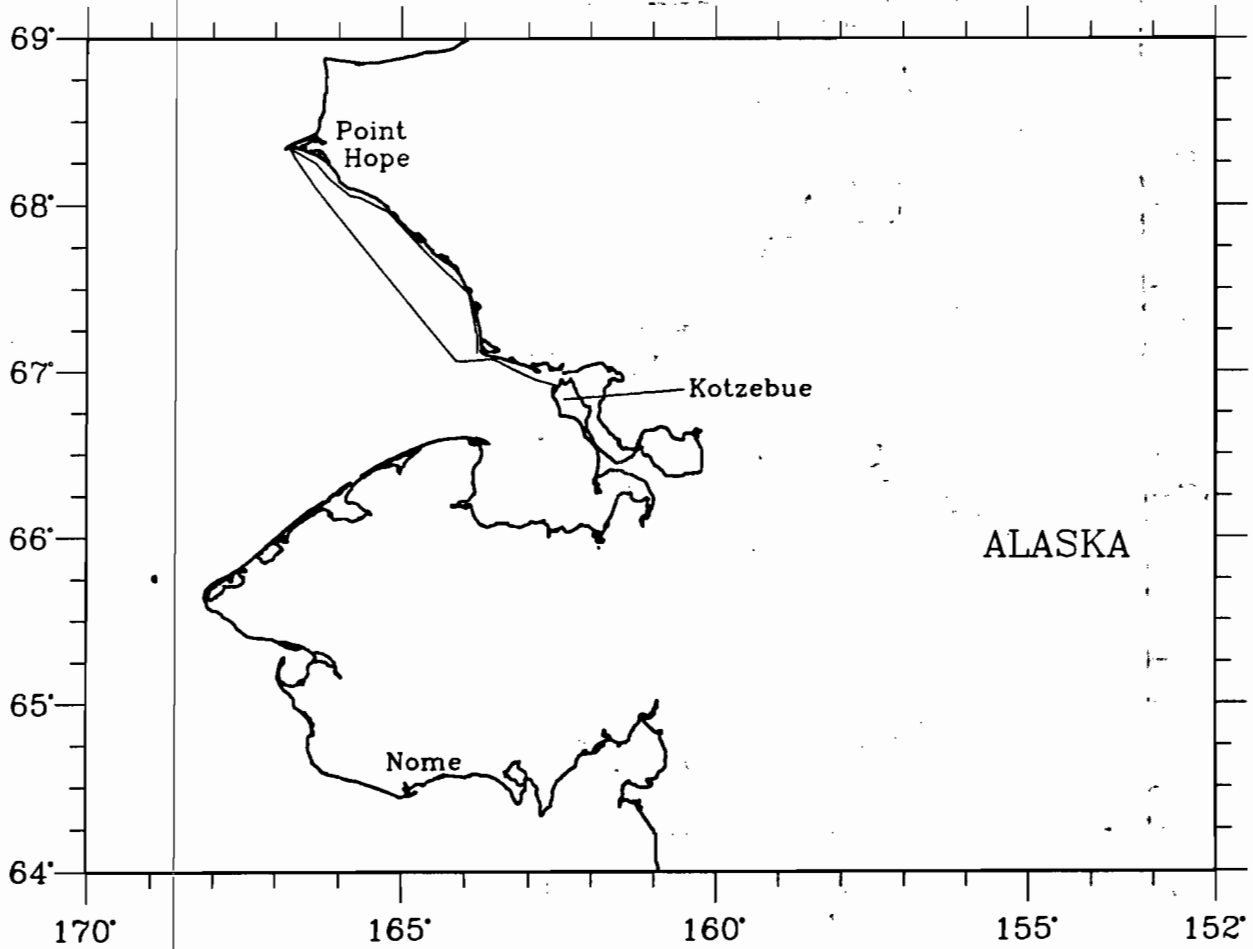

Flight 25: 6 November 1990

Flight was a transect survey of block 30 and portions of blocks 23 and 31; a survey in block 23 was curtailed due to extremely high seas. Weather was partly cloudy with fog, and visibility ranged from <1 km to unlimited. Sea state was Beaufort 02-06.

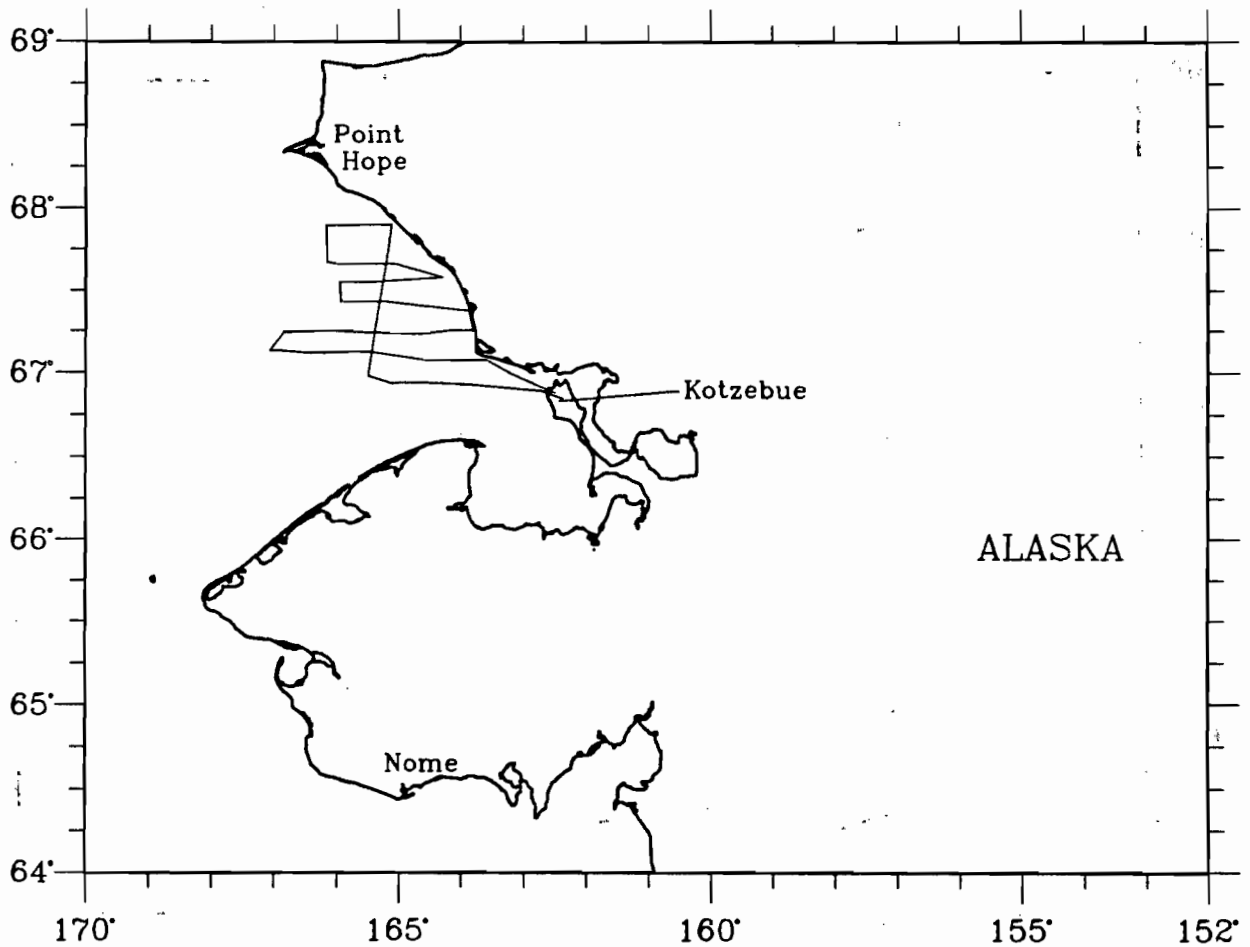

Flight 26: 7 November 1990

Flight was a transect survey of block 31; a survey in block 24 was cancelled due to high seas. Weather was partly cloudy with fog, and visibility ranged from <1 km to unlimited. Seastate was Beaufort 06-07. The innermost portions of Kotzebue Sound had 90% new ice cover with a sea state of Beaufort 01. Three unidentified pinnipeds were seen.

