

Exxon Company U.S.A.
Santa Ynez Unit Expansion Project
Harmony and Heritage Topsides Installation
June 15, 1992

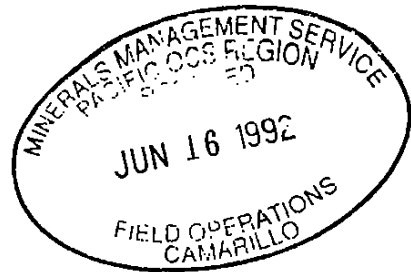

Table of Contents

Part I. McDermott Topsides Installation Execution Plan

- I. Introduction
- II. Mobilization, Preparation Activities, and Pre-Installation Work
- III. Typical Rigging and Lifting Activities
- IV. Typical Setting Activities
- V. Typical Weldout Activities and Equipment
- VI. Harmony Installation
- VII. Heritage Installation
- VII. Vessel Information
- IX. Anchor Plans

Part II. Pre-Hookup Execution Plan

1. Introduction
2. Scope of Work
3. Schedule
4. In-Place Contracting
5. Logistical Support
6. Overall Manning
7. Construction Equipment

Part III. Environmental Mitigation Report

1. Executive Summary
 2. Project Approval Background
 3. Relationship to Approved Project
 4. Project Description
 5. Marine Biological Resources
 6. Commercial Fishing
 7. Cultural Resources
 8. Air Quality
 9. Marine Water Quality
- Appendix I. Anchor Plans

Part IV. Topsides Installation Oil Spill Plan Addendum

1. Overall Pollution Incident Response Strategy
 2. Response Equipment
 3. Supplemental Vessel Information
- Attachment 1. Spill Response Emergency Flowchart
Attachment 2. Spill Report Form

Part V. Post Construction Survey Plan

1. Introduction
2. Scope and Objectives
3. Offshore Post-Construction Survey Plan

Project Description

This project involves the installation of topsides production modules on two previously installed jackets and the associated work to prepare the platforms for occupancy.

Platforms Harmony and Heritage's topsides are each composed of thirteen production modules. These modules are presently being fabricated in Aransas Pass, Texas, and will be transported to the Santa Barbara Channel on transportation barges. The modules will be lifted from the transportation barges and set onto the platform jackets with a derrick barge. Workers will weld the modules to the platform and perform piping and electrical connections to ready the platform for occupancy.

The enclosed Project Execution Plan prepared by McDermott, Inc. describes in detail all activities related to the module installation. Additionally, a Pre-Hookup Execution Plan is included to provide a complete picture of the construction activities during this time frame. These plans should be considered representative of the work activities only and should not be construed as precise definition of these activities. Deviations from the execution plans may be required based on actual site condition and unanticipated events. For this reason, the anchor plans include individual placement target zones to allow the vessel captain reasonable flexibility in setting anchors.

Three other documents are included in the document: an Environmental Mitigation Report, an Oil Spill Addendum for Topsides Installation, and a Post Construction Site Clearance Plan. The Environmental Mitigation Report summarizes findings of previous environmental studies and describes Exxon mitigation of identified impacts. The Oil Spill Addendum for Topsides Installation discusses the procedures and equipment to be used in the event of a spill. The Post Construction Survey Plan describes the geophysical survey that will be performed when construction of the platforms is complete.

EXXON COMPANY, U.S.A.

TRANSPORTATION AND INSTALLATION

of

HARMONY AND HERITAGE TOPSIDES

for the

SANTA YNEZ UNIT EXPANSION PROJECT

EXECUTION PLAN

Submitted by:

McDermott Incorporated
1010 Common St.
P.O. Box 60035
New Orleans, LA 70160

Rev. 0	Dated	04/15/92
Rev. 1	Dated	05/08/92

EXXON, U.S.A.
Harmony & Heritage Platforms
Santa Ynez Unit Expansion
Topsides Installation
Execution Plan

I. INTRODUCTION

II. MOBILIZATION, PREPARATION ACTIVITIES, AND PRE-INSTALLATION
WORK

III. TYPICAL RIGGING AND LIFTING ACTIVITIES

IV. TYPICAL SETTING ACTIVITIES

V. TYPICAL WELDOUT ACTIVITIES AND EQUIPMENT

VI. HARMONY INSTALLATION

VII. HERITAGE INSTALLATION

VIII. VESSEL INFORMATION

IX. ANCHOR PLANS

I. INTRODUCTION

This execution plan has been prepared by McDermott International, Inc. to facilitate permitting for the Harmony and Heritage Topsides Installation .

McDermott has been contracted by Exxon to perform the transportation and installation of the Harmony and Heritage topsides modules. These modules are currently being fabricated in Aransas Pass, Texas. Approximately one month before the installation work begins in Santa Barbara Channel, the modules will be loaded out from the construction yard onto eight transportation barges and secured for the tow with sea fasteners. The barges will each be towed from the Gulf of Mexico through the Panama Canal and up the West Coast to arrive in the Santa Barbara Channel as needed. The modules will then be lifted from the barges, set on the previously installed platform jackets, and secured in place. McDermott plans to commence operations in Santa Barbara Channel in early October 1992. All installation work, including cleanup and demobilization, should be completed by late December 1992. *Exhibit I-A shows the Harmony and Heritage Installation Schedules.*

This document describes the operations required to install the modules. Section II describes McDermott's mobilization, field preparation activities, and pre-installation work. Section III through V describe the typical rigging, lifting, setting, and welding operations required for the installation of each module as well as any contingency plans considered. Sections VI and VII contain specific details about the installation activities at Harmony and Heritage. Section VIII contains descriptions and specification of all vessels currently planned for the work. Section IX describes the DB 51 anchoring system and McDermott's method of setting the anchors. A map is included in this section showing the expected anchor placements.

This document in its entirety is intended to be representative of the work activities only, and should not be construed as a precise definition of these activities. Deviations from this plan may be required based on actual site conditions and unanticipated events.

Exhibit I-A

Harmony and Heritage

Installation Schedules

EXXON COMPANY, U.S.A.

Schedules include weather and mechanical downtime;
No allowance for shimming/leveling

HARMONY INSTALLATION SUMMARY

OCTOBER	1992	NOVEMBER
Set Up Derrick Barge 51	17 06:00 19 18:00	
Sump	19 18:00 19 24:00	
West and East MSFs	20 00:00 22 06:00	
AI. Module	22 06:00 24 18:00	
CL Module	24 18:00 27 02:00	
BL Module	27 02:00 29 12:00	
DL Module	29 12:00 31 22:00	
AU Module	31 22:00 06 06:00	
		CU Module
		06 06:00 08 18:00
		Quarters Module
		08 18:00 09 22:00
		BU Module
		09 22:00 11 24:00
		DU Module
		12 00:00 14 02:00
		BX Module
		14 02:00 15 06:00
		Vent Boom
		15 06:00 16 22:00
		Process Heaters
		15 22:00 16 04:00
		Miscellaneous Packages
		16 04:00 16 18:00
		Pick Up Anchors
		17 18:00 17 18:00

McDermott, Inc.

06MAY92

EXXON COMPANY, U.S.A.

Schedules include weather and mechanical downtime;
No allowance for shimming/leveling

HERITAGE INSTALLATION SUMMARY:

NOVEMBER	1992	DECEMBER
18 18:00 21 08:00 Set Up Derrick Barge 51		
21 08:00 21 16:00 Sump		
21 16:00 24 02:00 West and East MSFs		
24 02:00 28 16:00 AL Module		
28 16:00 29 06:00 CL Module		
29 06:00 01 20:00 BL Module		
01 20:00 04 10:00 DL Module		
04 10:00 09 22:00 AU Module		
		09 22:00 12 12:00 CU Module
		12 12:00 13 22:00 Quarters Module
		13 22:00 16 04:00 BU Module
		16 04:00 18 10:00 DU Module
		18 10:00 19 18:00 BX Module
		19 18:00 20 12:00 Vent Boom
		20 12:00 20 20:00 Process Heaters
		20 20:00 21 10:00 Miscellaneous Packages
		21 10:00 22 12:00 Pick Up Anchors

II. MOBILIZATION, PREPARATION ACTIVITIES, AND PRE-INSTALLATION WORK

Preparatory work includes personnel mobilization, derrick barge rig up, and top of jacket preparatory work. Derrick barge rig up and top of jacket preparatory work should take approximately four days.

The derrick barge DB 51 will be towed from the Gulf of Mexico through the Straits of Magellan and up the west coast of South America towards the Santa Barbara Channel. A riding crew will be onboard the derrick barge DB 51. Other McDermott personnel will be flown into Los Angeles, bussed to Port Hueneme, and then transported by crew boat from Port Hueneme to the DB 51. The DB 51 deck crane will be used to lift personnel off the crew boat.

The personnel will begin visual inspection, mechanical testing and inspection, and various "start-up" type operational procedures. Mechanical equipment will be unsecured from seafastening clips and tested.

After the DB 51 arrives at the Harmony worksite, anchoring will be achieved by using an anchor handling tug to place the anchors at the preselected sites (*see Section IX- Anchor Plans*). Prior to anchoring, one McDermott work crew will be onboard the DB 51.

Top of jacket prep work consists of removing navigation aids and surveying the top of jacket in order to establish the transition piece cutoff elevation. Scaffolding will be installed to allow access to the center of the jacket at the (+) 15 ft level and at each leg transition piece. A vertical member will be installed in the center of the jacket at the (+) 15 ft level and a reference mark will be made on the vertical member at (+) 22 ft. Using a water level, each transition piece will be marked at the appropriate elevation and cut using a beveling band. The bevel will be visually inspected for proper alignment and configuration.

Scaffolding installed at each leg will be used to access the existing navigation aids. Prior to setting the module support frames, the navigation aids must be removed and modified so that they can be reinstalled at any point during the installation

sequence. This would be necessary, for example, if the DB 51 must leave the worksite due to extreme weather conditions.

III. TYPICAL RIGGING AND LIFTING ACTIVITIES

Rigging will be used to lift each module from the transportation barge and to place each module on the jacket structure. A typical rigging assembly consists of lifteyes, shackles, slings, and spreader bars (*see Exhibit III-A*). Since lifteyes are such a critical component during lift, they are designed with a 2.0 Safety Factor. Members framing into the lifteye are also designed for a 2.0 Safety Factor. All rigging is designed in accordance with API RP2A. For four point lifts, the static forces are assumed to be distributed 75% to one pair of diagonally opposed slings and 25% to the other pair. In addition, all slings and accessories are selected for the maximum loads.

Each module is lifted at four points (*see Exhibit III-B and Exhibit III-C*). From each lift point, rigging connects the lifteye with the derrick barge crane main hook. The rigging is made up of four slings, one from each lifteye to the hook. The lifteyes have been angled towards the module center of gravity to eliminate the use of spreader bars on all modules except Module BX. Module BX will be lifted using a spreader bar (*see Exhibit III-D*).

Rigging on the Module Support Frames, the lower modules and the Quarters Modules will be pre-installed at the fabrication yard in Aransas Pass, Texas. The preinstalled lift rigging will be installed so that only one connection of each sling to the crane hook is required. The "pre-rigged" structures will have temporary support structures (*see Exhibit III-E*) used to carry the rigging assembly during tow and to protect sensitive equipment from damage. Rigging on the upper modules will be field installed. The sling assemblies used on the lower modules will be inspected before being reused on the upper modules. Lifting the upper modules will require that the rigging be installed by McDermott crews offshore at each lifteye.

The transportation barge will be placed next to the derrick barge (*see Exhibit III-C*). McDermott crews will begin removing tiedowns from each module and attaching the rigging to the derrick barge main hook. Activities will be scheduled so that all four slings will be attached to the crane hook before the last tiedown brace is removed from the module. Upon completion of tiedown removal, a McDermott representative will visually inspect all tiedown points to confirm proper removal.

During the lift, air tuggers with tag lines attached to the lifted structure will be used to control its lateral movement.

During setting operations (positioning the module using the designed bumper guides) the average boom tip motion will be limited to approximately 3 feet. The derrick barge superintendent shall determine weather conditions unsuitable to make a lift.

Weather reports will be monitored continuously during operations. If unacceptable weather is encountered, the lift will be delayed until the derrick barge superintendent determines that it is safe to lift.

Exhibit III-A

Typical Rigging Assembly

TYPICAL RIGGING ASSEMBLY

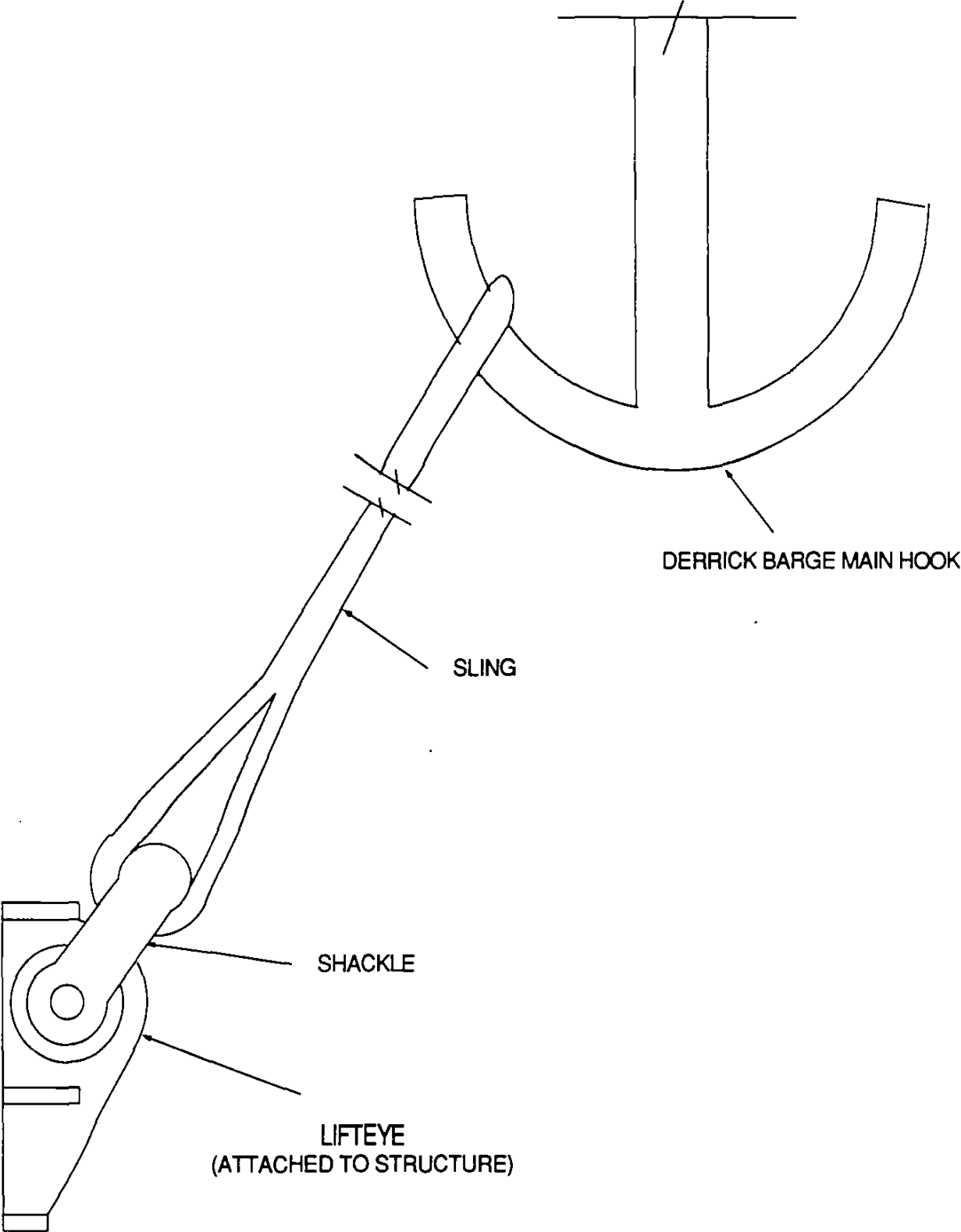

Exhibit III-B

Typical Lift Sketch

Elevation View

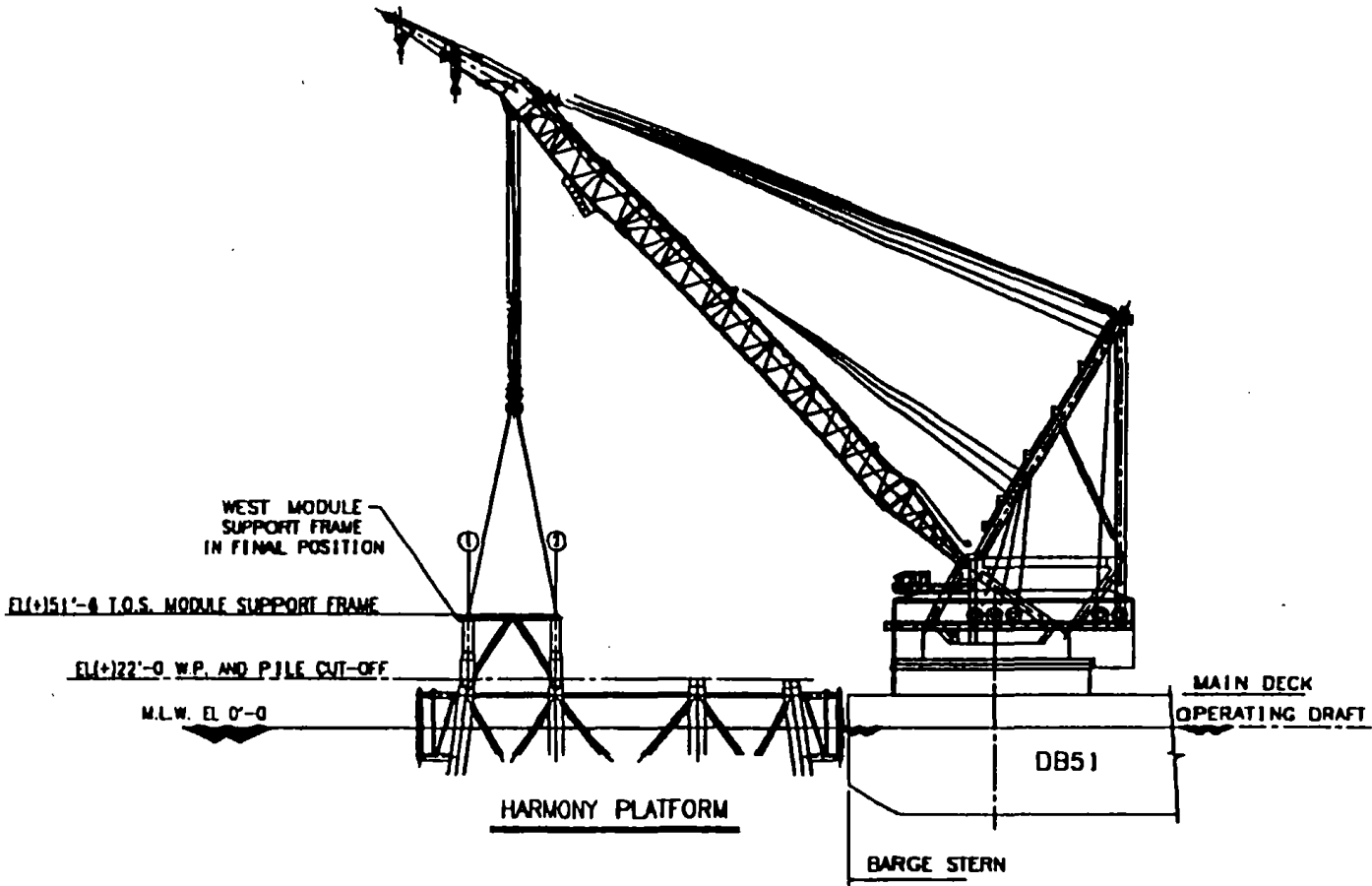
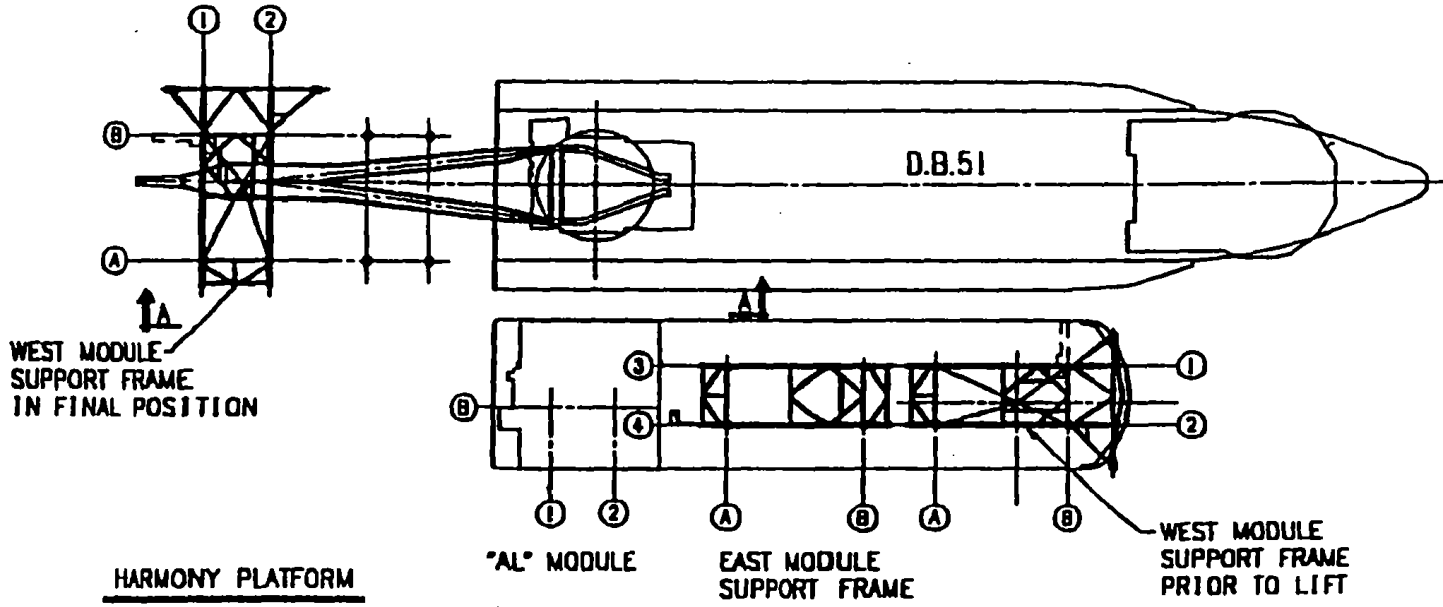

Exhibit III-C

Typical Lift Sketch

Plan View

PLATFORM NORTH



TRANSPORTATION
BARGE NO. 1

Exhibit III-D

Typical Lift Sketch

Module BX

MODULE "BX" LIFT SKETCH

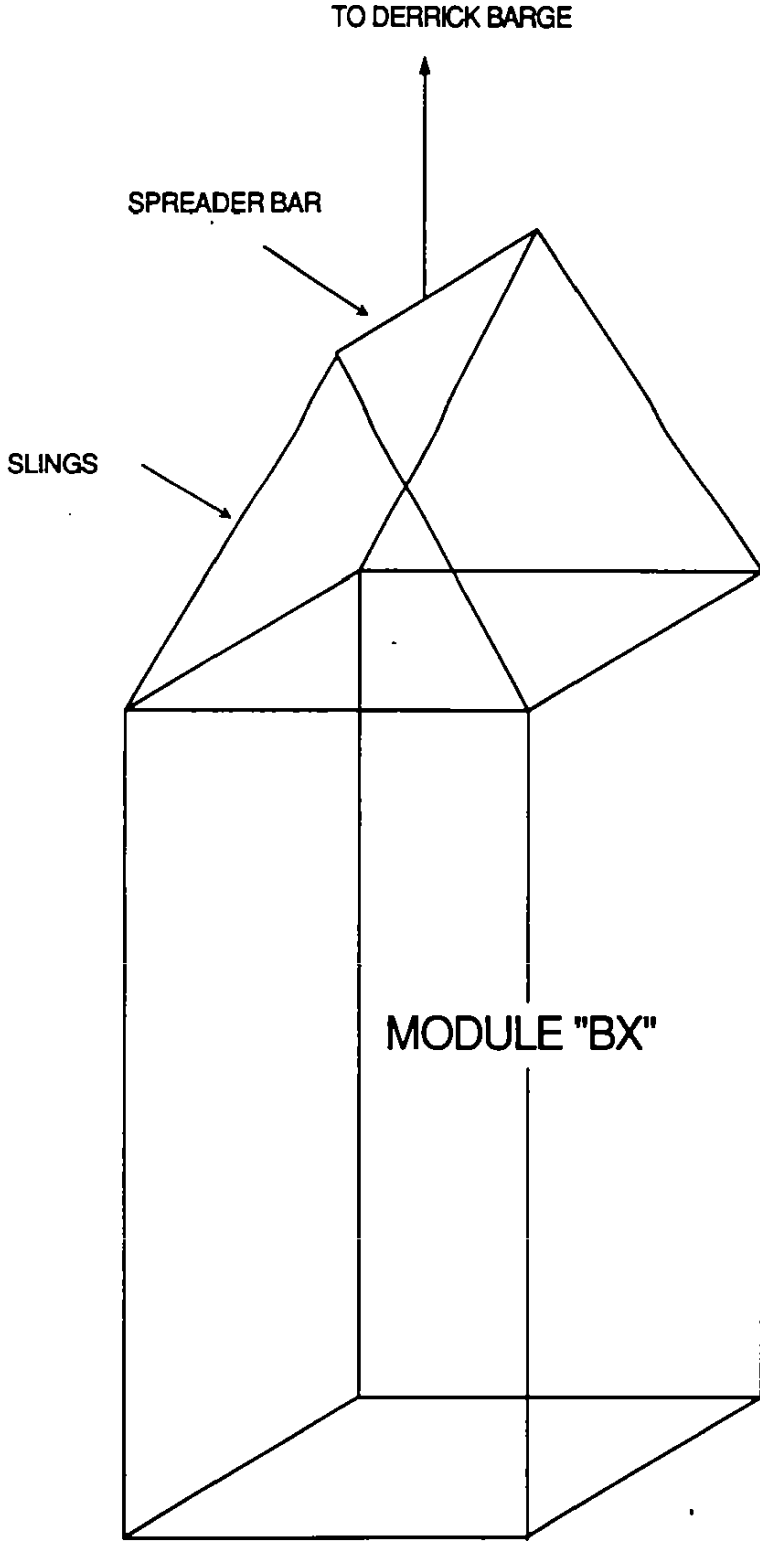
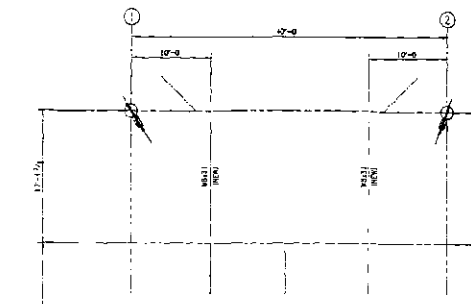
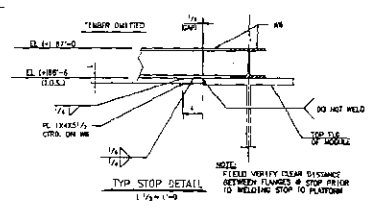

Exhibit III-E

Typical Rigging Support Structures



PARTIAL PLAN
J.A.S. D. 11.01.87-3
7/16" x 1'-0"
"AL" MODULE



TYP STOP DETAIL
1 1/2" x 1'-0"

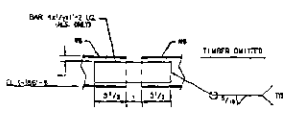

SECTION "A-A"
1 1/2" x 1'-0"

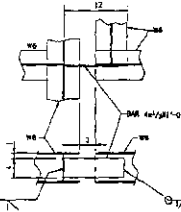

SECTION "B-B" (SHN)
SECTION "C-C" (OPPI)
1 1/2" x 1'-0"

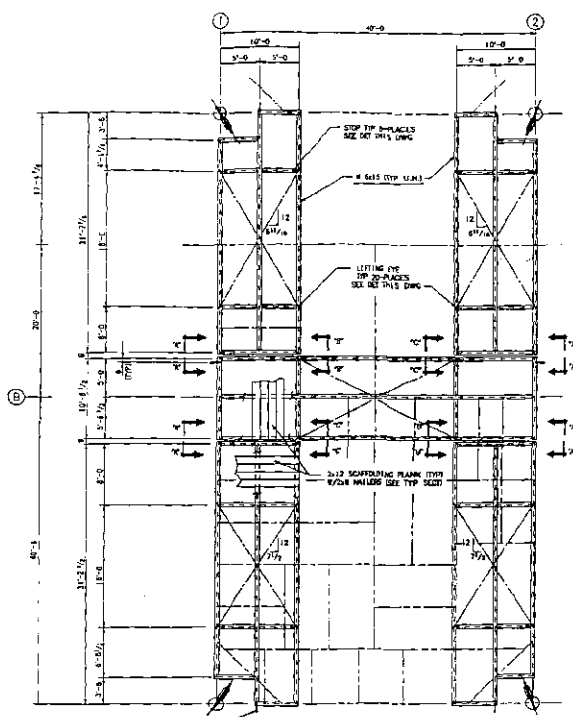

PLAN
J.A.S. D. 11.01.87-3
7/16" x 1'-0"
"AL" MODULE

APPROVED
FOR CONSTRUCTION

NOTE:
MODIFY TO REMOVE RIGGING PLATFORM
AFTER INSTALLATION OF "AL" MODULE.

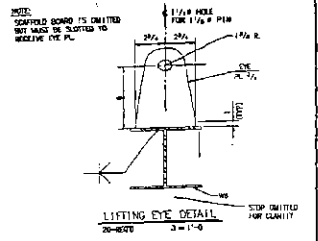

LIFTING EYE DETAIL
20'-0"
3'-11"

- LIFTING NOTES:
- LIFTING WT OF HEAVIEST SECTION (CONCRETE PORTLANDS 2.5 TONS)
 - MAXIMUM STATIC SLING LOAD IS 10 SHORT TONS
 - SLINGS SHALL BE MIN. 1" x 8" x 30'-0" LONG
 - 4-8" RINGS (BENDING STRENGTH 1500 LBS)
 - SHOCKLE SHALL BE CROSS "Y" BOLT TYPE ANCHOR W/ 3/4" DIA. BUSH
 - RIGGING PLATFORM IS NOT DESIGNED FOR LIFT WITH THE WEIGHT OF THE MODULE SLINGS.

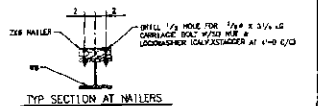

TYP SECTION AT NAILERS
1 1/2" x 1'-0"

- NOTE:
- A COP OF 1/4" THICK 1-9" SHALL BE ADDED BETWEEN NAILERS
 - ALL TIMBER SHALL BE FULL SIZE SH2, OR 2-8"
 - EACH PIECE OF TIMBER SHALL HAVE 4-16# GALV NAILS DELIVER @ 6" SP.

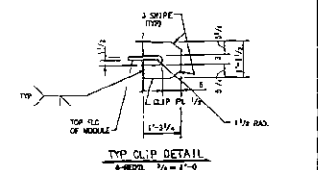

TYP CLIP DETAIL
8'-0"
7'-0"

NO.	DESCRIPTION	DATE	BY	CHECKED	APPROVED
1	DESIGN				
2	CONSTRUCTION				
3	AS-BUILT				

TRANSPORTATION AND INSTALLATION OF HARMONY AND HERITAGE TOPSIDES

EXXON COMPANY USA

McDERMOTT INCORPORATED

HARMONY "AL" MODULE RIGGING PLATFORM

IV. TYPICAL SETTING ACTIVITIES

Prior to setting the Module Support Frames, the top of jacket elevation will be levelled by cutting the transition pieces as described in Section II. The Module Support Frames can then be set into the transition pieces.

After setting the Module Support Frames, the vertical levelness will be checked. A water level will be used to measure levelness at the top of the Module Support Frames. If the Module Support Frame is out of level, shim plates will be used to achieve desired setting tolerances before setting the lower modules.

A pin and bucket system and a 12 ft high bumper/docking system are employed to set the modules. The pin and bucket system (*see Exhibit IV-A*) is used to guide the modules vertically into final position and is designed to ensure each module is located within specified horizontal tolerance. The bumper/docking system (*see Exhibit IV-B*) is used to absorb the primary and secondary lateral impact energy before the modules are lowered onto the pin and bucket. The bumper/docking system is designed to take a primary impact equal to 10% of the module weight and a secondary impact factor equal to 5% of the module weight. These impact factors have been used by McDermott to design successful bumper/docking systems for many years and have been established through actual lift experience. After the primary impact is absorbed, air tuggers and the boom will pull the structure towards the secondary stop. This loading will be less than the initial impact. The structure approaches the secondary stop, a "catcher" (*see Exhibit IV-C*) will halt the structure's motion. At this point, the structure can then be lowered onto the pin and bucket system.

If the lower modules do not meet specified setting tolerances, shim plates will be added to achieve vertical levelness and the module will be maneuvered with hydraulic jacks to achieve horizontal setting tolerances. Before the upper modules are set, the lower modules will be located within specified setting tolerances.

As each structure is set, its slings will be lowered back onto the rigging support structure or onto the top deck in order that they can be removed one at a time with the derrick barge. Care will be taken to avoid damaging the structure and mechanical equipment while lowering/lifting the slings. Upon removal of all four

slings, the rigging support structure will be removed and placed on the transportation barge.

Exhibit IV-A

Pin and Bucket System

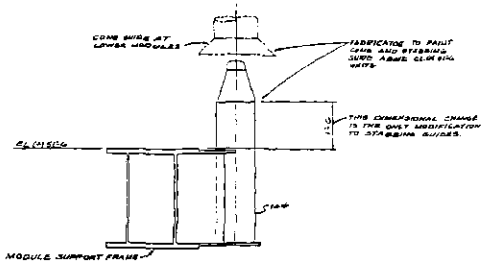

LOWER MODULE STABILIZING GUIDE MODIFICATION
 3-LOCATIONS
 2/17/70

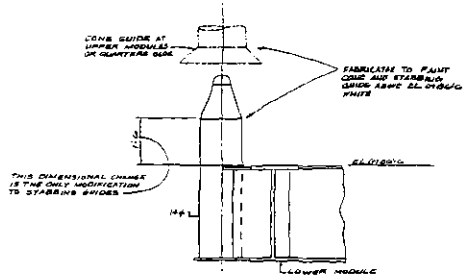

UPPER MODULE & QUARTER STABILIZING GUIDE MODIFICATION
 10-LOCATIONS
 2/17/70

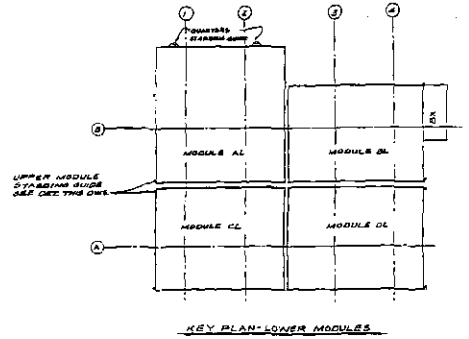
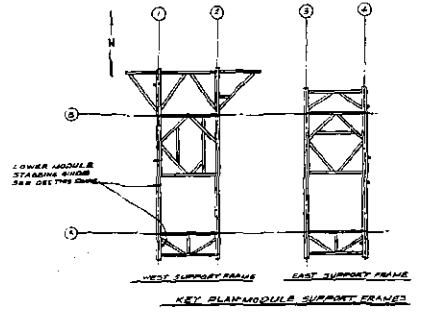

APPROVED
 FOR CONSTRUCTION

	TRANSPORTATION AND INSTALLATION OF HARMONY AND HERZOG TOWERES 1000 WEST 10TH AVENUE DENVER, COLORADO 80202
	EXXON COMPANY, USA 6000 WEST 10TH AVENUE DENVER, COLORADO 80202
	ENGINEERED BY MCDERMOTT INCORPORATED 1000 WEST 10TH AVENUE DENVER, CO. 80202
	DRAWN BY MCDERMOTT INCORPORATED 1000 WEST 10TH AVENUE DENVER, CO. 80202

NO.	DATE	DESCRIPTION	BY	CHECKED	APPROVED
1	2/17/70	ISSUED FOR CONSTRUCTION	EL		
2					
3					
4					
5					
6					
7					
8					
9					
10					

Exhibit IV-B

Bumper/Docking System

Exhibit IV-C

Typical "Catcher" Sketch

V. TYPICAL WELDOUT OPERATIONS AND EQUIPMENT

After each module's position has been reviewed and approved by Exxon, it will be welded to the structure at each support point (*see Exhibit V-A*). To access the set down points, temporary scaffolding will be installed at each point. The scaffolding will be installed at the module fabricator's yard.

All welding will be performed in accordance with Exxon's approved welding procedures. After a weld is completed, the weld will be visually inspected and NDE performed in accordance with the approved quality assurance plan.

Exhibit V-A

Typical Module Bearing Sketch

TYPICAL MODULE BEARING SKETCH

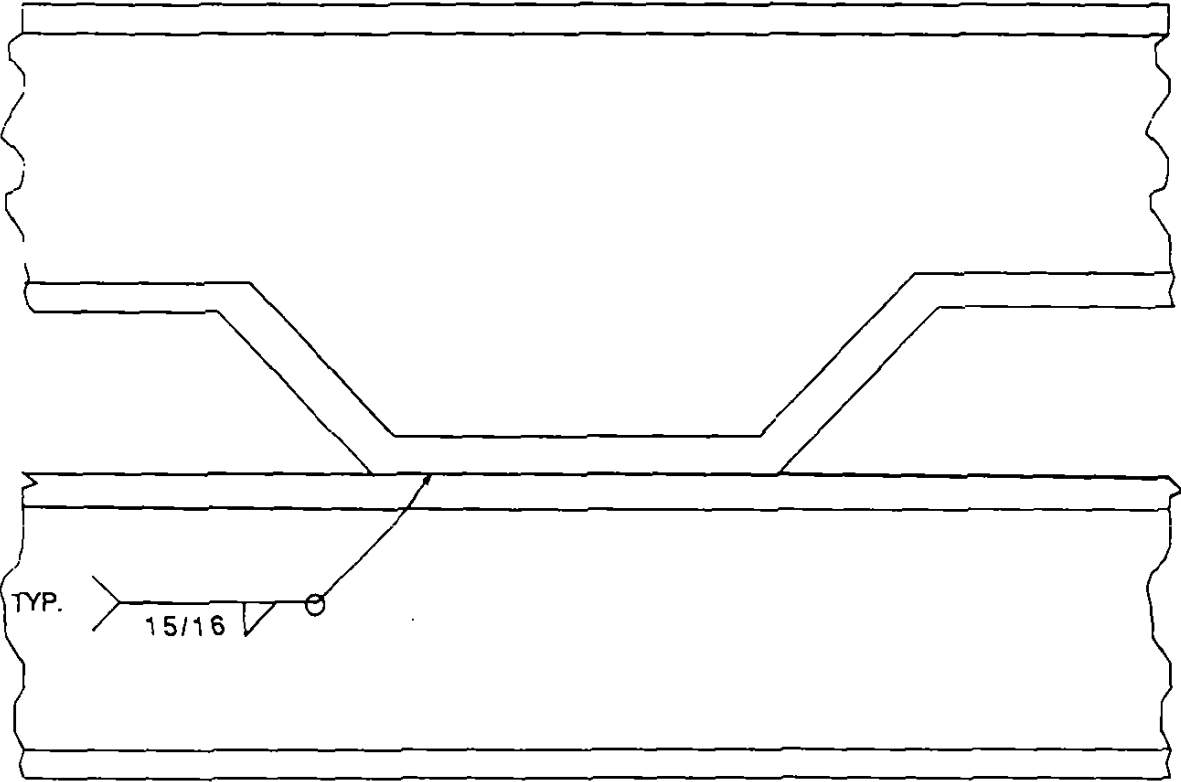

ELEVATION VIEW

VI. HARMONY INSTALLATION

Prior to installing the modules, the derrick barge will be anchored, the navigation aids will be removed, and the transition piece cut offs will be complete. Typical work entails positioning of the transportation barge next to the derrick barge, lifting the cargo off the barge, and then setting it onto the platform (*see Exhibit VI-A*). The transportation barges will arrive on site one at a time. After the transportation barge is positioned next to the derrick barge, work crews will then begin removing tiedowns prior to lifting the cargo. After the cargo is placed onto the platform, it will be surveyed to determine levelness. If necessary, the placed structure will then be shimmed to achieve levelness. After the module's position has been accepted, the module will be welded to the platform.

The following table gives the Harmony Installation Schedule by Transportation Barge. *See Exhibits VI-B through VI-E for component arrangement on barges.*

Barge	Component	Expected Duration	Installation Order	Comments
1	54"Ø Skim Pile	1 day	1	Placed on Platform
	West Module Support Frame	1 day	2	Placed on Platform
	East Module Support Frame	1 day	3	Placed on Platform
	Module AL	2 days	4	Placed on Platform
2	Module CL	2 days	1	Placed on Platform
	Module BL	2 days	2	Placed on Platform
	Module DL	3 days	3	Placed on Platform
	Electric Crane Boom	-	-	Stored on DB 51
	Construction Generators	-	-	Stored on DB 51
	Shipping Containers (2)	-	-	Stored on DB 51
	Blue Rooms (4)	-	-	Stored on DB 51
3	Module AU	4 days	1	Placed on platform
	Module CU	3 days	2	Placed on platform
	Quarters Module	1 day	3	Placed on platform
	Flare Boom	1 day	-	Stored on DB 51
	Central Process Heaters (2)	-	-	Stored on DB 51
	Shipping Container	-	-	Stored on DB 51
4	Module BU	2 days	1	Placed on Platform
	Module DU	2 days	2	Placed on Platform
	Module BX	2 days	3	Placed on Platform
	Flare Boom	2 days	4	Removed from DB 51
	Process Heaters	-	5	Removed from DB 51
	Miscellaneous Packages	-	6	Removed from DB 51

Upon completion of Harmony Installation, the navigation aids will be replaced, anchors will be picked up, and the derrick barge will be moved to Heritage Platform. Expected duration is 2 days.

Exhibit VI-A

Typical Derrick Barge Positioning Sketch

PLATFORM NORTH
↑

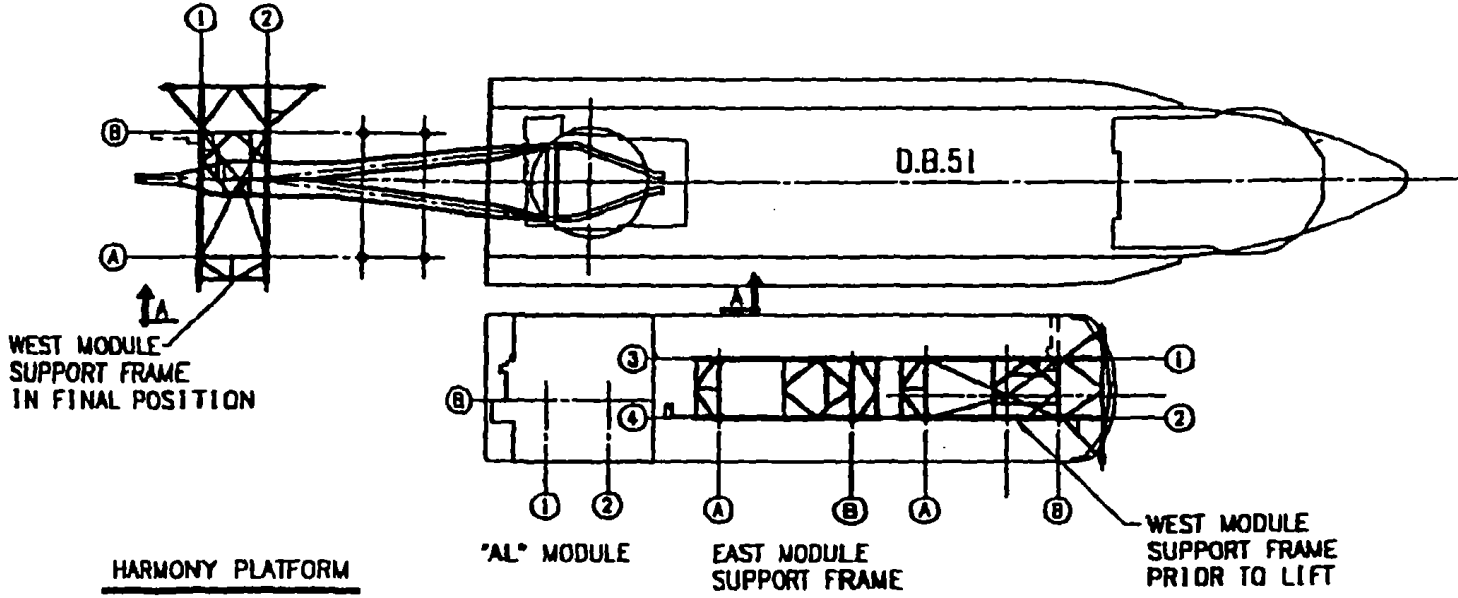

HARMONY PLATFORM

TRANSPORTATION
BARGE NO. 1

Exhibits VI-B - VI-E

Transportation Barge No. 1
Transportation Barge No. 2
Transportation Barge No. 3
Transportation Barge No. 4

Exhibit VI-B

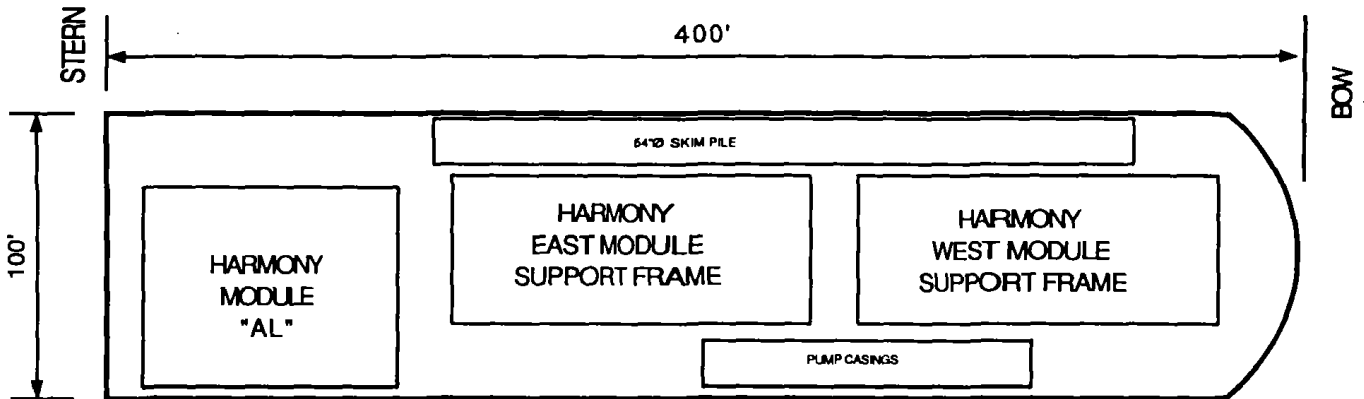

TRANSPORTATION BARGE NO. 1

PLAN VIEW

Exhibit VI-C

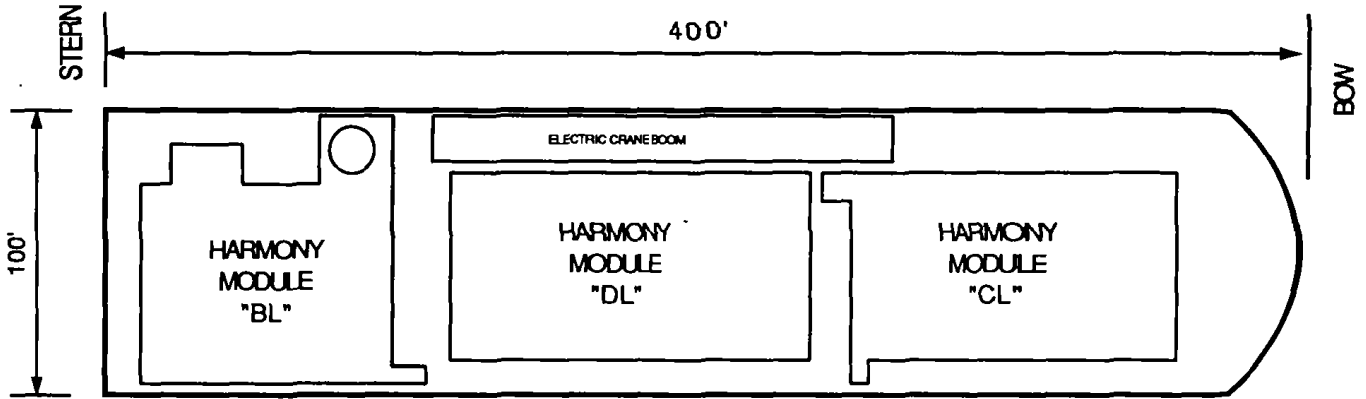

TRANSPORTATION BARGE NO. 2

PLAN VIEW

Exhibit VI-D

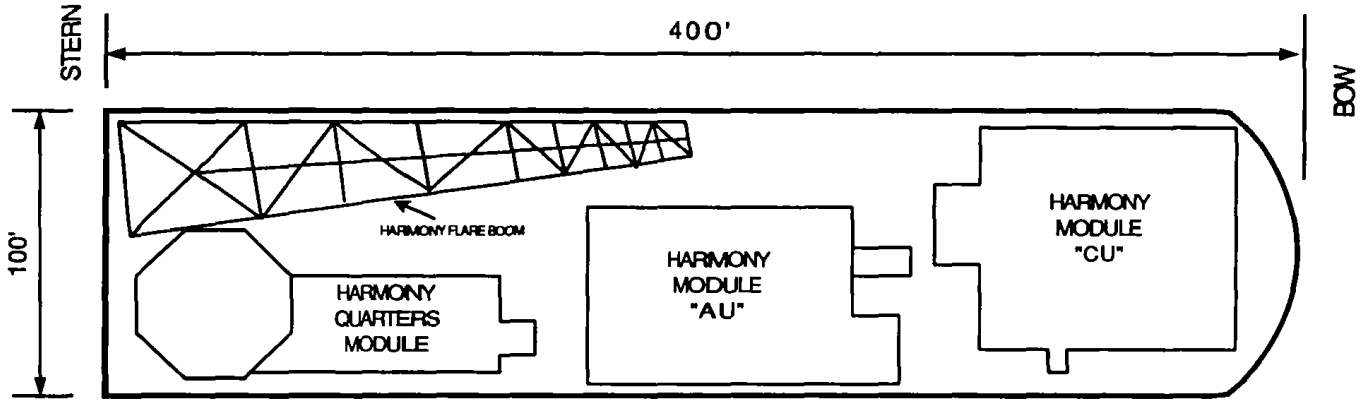

TRANSPORTATION BARGE NO. 3

PLAN VIEW

Exhibit VI-E

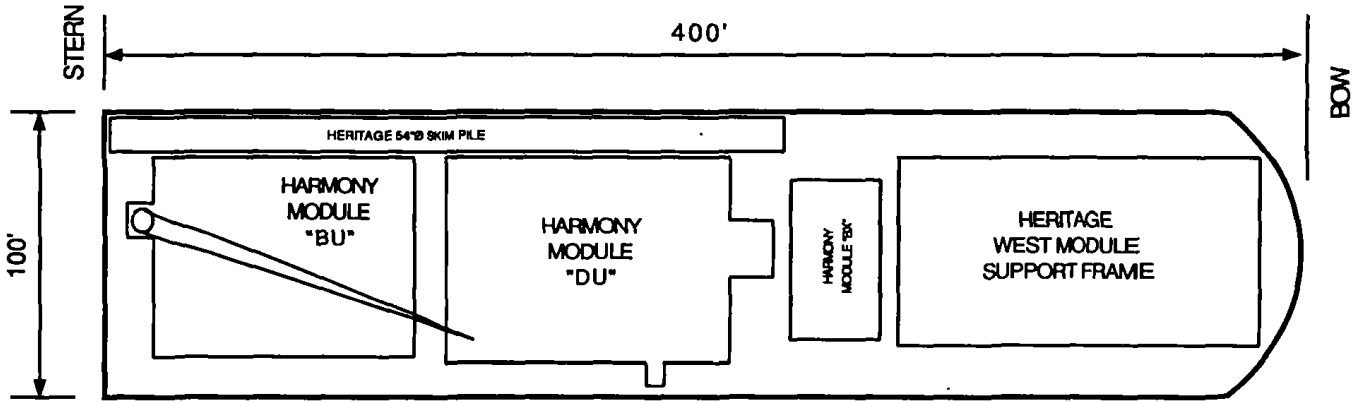

TRANSPORTATION BARGE NO. 4

PLAN VIEW

VII. HERITAGE INSTALLATION

After completion of Harmony Installation, the derrick barge and fourth transportation barge will be towed to the Heritage Platform. Prior to installing the modules, the derrick barge will be anchored, the navigation aids will be removed, and the transition piece cut offs will be completed. Expected duration is 2 days.

Typical work entails positioning of the transportation barge next to the derrick barge, lifting the cargo off the barge, and setting it onto the platform. The transportation barges will arrive on site one at a time. After the transportation barge is positioned next to the derrick barge, work crews will begin removing tiedowns prior to lifting the cargo. After the cargo is placed onto the platform, it will be surveyed to determine position. If necessary, the placed structure will be shimmed to achieve levelness. After the module's position has been accepted, the module will be welded to the platform.

The following table gives the Harmony Installation Schedule by Transportation Barge. See Exhibits VII-A through VII-D for component arrangement on barges.

<u>Barge</u>	<u>Component</u>	<u>Expected Duration</u>	<u>Installation Order</u>	<u>Comments</u>
*	Relocate DB 51	2 days	-	Harmony to Heritage
4	54"Ø Skim Pile	1 day	1	Placed on Platform
	West Module Support Frame	1 day	2	Placed on Platform
5	East Module Support Frame	1 day	1	Placed on Platform
	Module AL	3 days	2	Placed on Platform
	Module CL	2 day	3	Placed on Platform
	Shipping Containers (6)	-	-	Stored on DB 51
	Construction Generators (2)	-	-	Stored on DB 51
6	Module BL	3 days	1	Placed on Platform
	Module DL	3 days	2	Placed on Platform
	Module AU	5 days	3	Placed on Platform
	Blue Rooms (4)	-	-	Stored on DB 51
7	Module CU	3 days	1	Placed on platform
	Quarters Module (from Barge 8)	1 day	2	Placed on platform
	Flare Boom (from Barge 8)	1 day	-	Stored on DB 51
	Module BU	2 days	3	Placed on platform
	Module DU	2 days	4	Placed on platform
	Module BX	2 days	5	Placed on platform
	Process Heaters (2)	-	-	Stored on DB 51
8	Flare Boom	2 days	1	Removed from DB 51
	Process Heaters (2)	1 day	2	Removed from DB 51
	Miscellaneous Packages	1 day	3	Removed from DB 51

Upon completion of Heritage Installation, the navigation aids will be replaced, anchors will be picked up, and the derrick barge will then be moved off site. Expected duration is 2 days.

Exhibits VII-A - VII-D

Transportation Barge No. 5
Transportation Barge No. 6
Transportation Barge No. 7
Transportation Barge No. 8

Exhibit VII-A

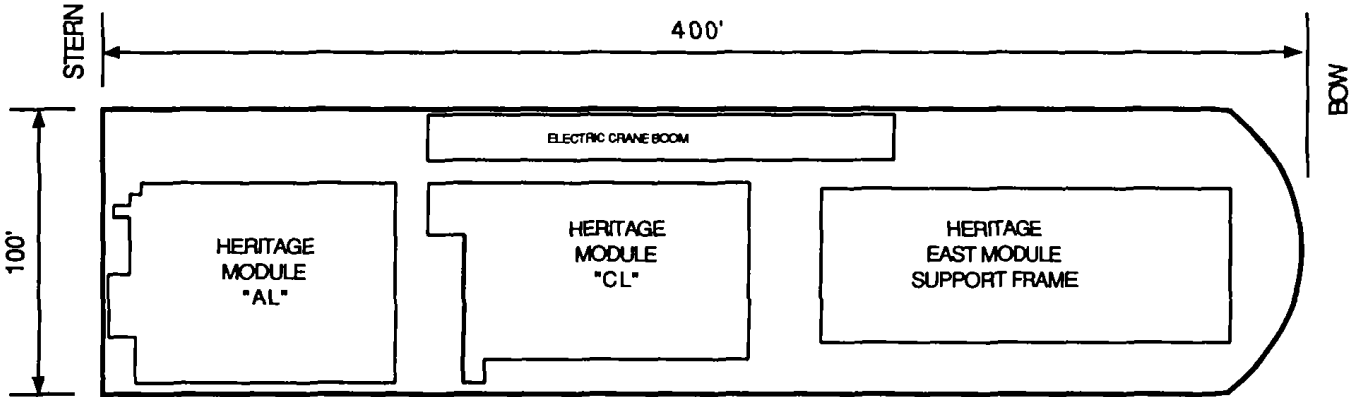

TRANSPORTATION BARGE NO. 5

PLAN VIEW

Exhibit VII-B

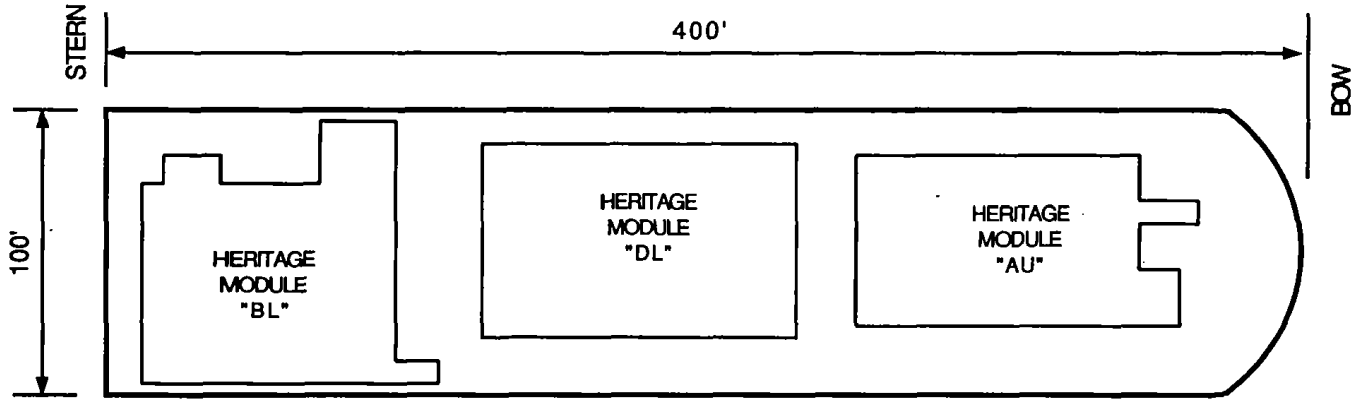

TRANSPORTATION BARGE NO. 6

PLAN VIEW

Exhibit VII-C

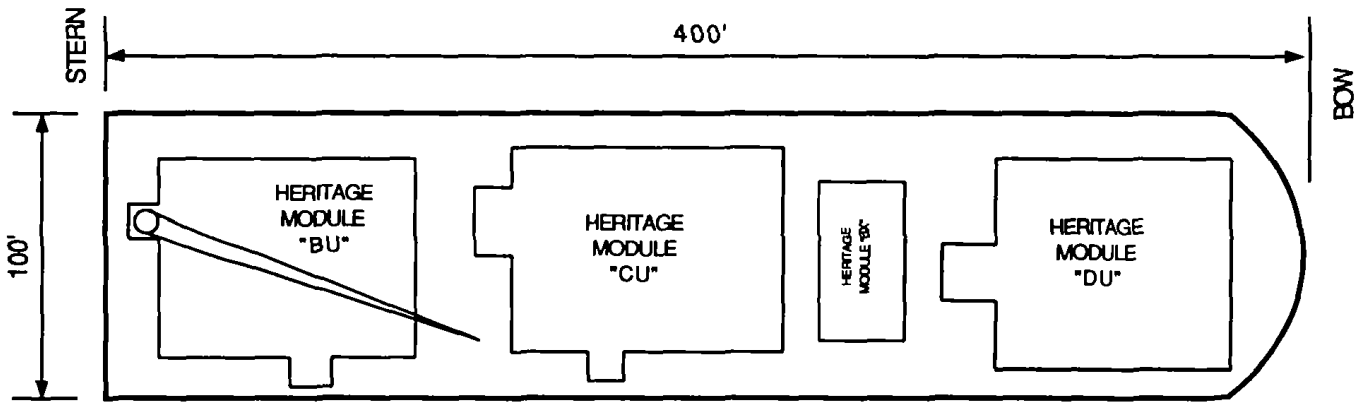

TRANSPORTATION BARGE NO. 7

PLAN VIEW

Exhibit VII-D

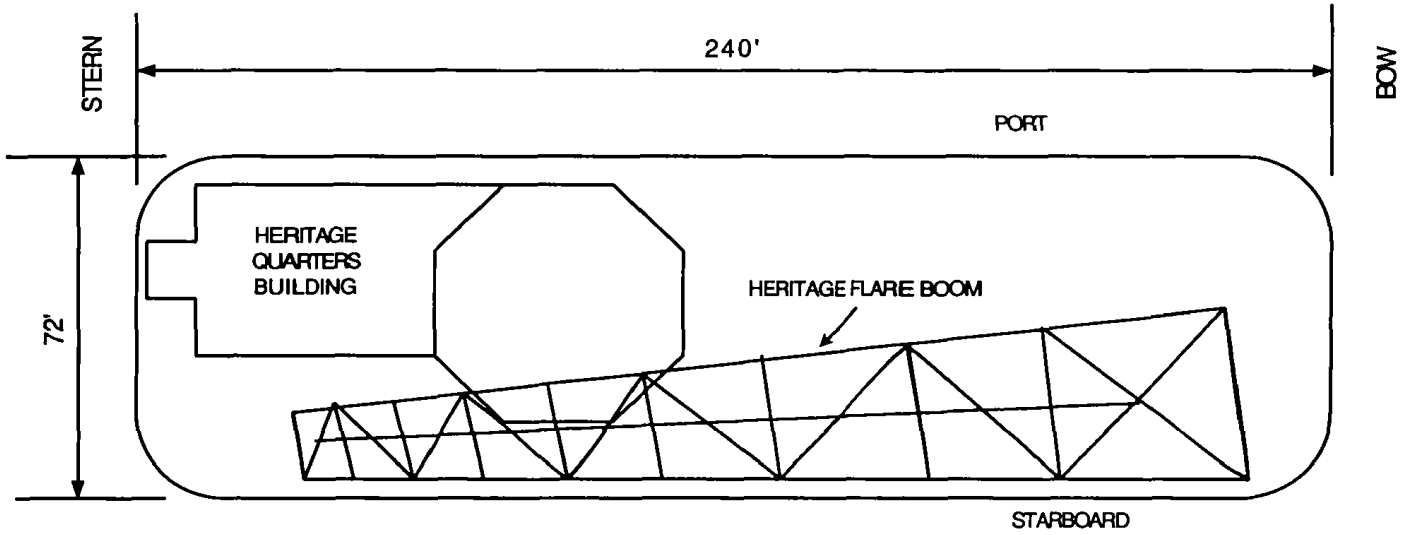

TRANSPORTATION BARGE NO. 8

PLAN VIEW

VIII. VESSEL INFORMATION

The McDermott DB 51 (*see Exhibit VIII-A*) will be used for the Harmony and Heritage Topsides Installation. Overall vessel dimensions are 584' x 140' x 54'. Lifting capacity is 2700 tons.

Crowley Maritime Corporation will provide the following equipment for the Harmony and Heritage Topsides Transportation:

<u>Tugs</u>	<u>Transportation Barges</u>
Sea Racer	411
Sea Wolf	417
Sea Lion	419
Vigilant	Isla Del Sol
Samson	415
Daring	420
Sea Monarch	St. Thomas

A typical specification sheet is attached for the tugboats (*see Exhibit VIII-B*).

Typical barge drawings are attached for the Crowley transportation barge (*see Exhibit VIII-C*).

One McDermott-owned Tidelands 'O' Series barge will also be used for the Topsides transportation. Typical barge information is provided for the Tidelands barge (*see Exhibit VIII-D*).

An information sheet is attached for the Jaramac 69 anchor handling tug (*see Exhibit VIII-E*). In addition to using the Jaramac 69, McDermott will charter an anchor handling tug on the West Coast to assist in anchor setting operations.

All marine vessels, except the DB 51, will use timing retard to minimize NO_x emissions.

Exhibit VIII-A

McDermott Derrick Barge

DB 51

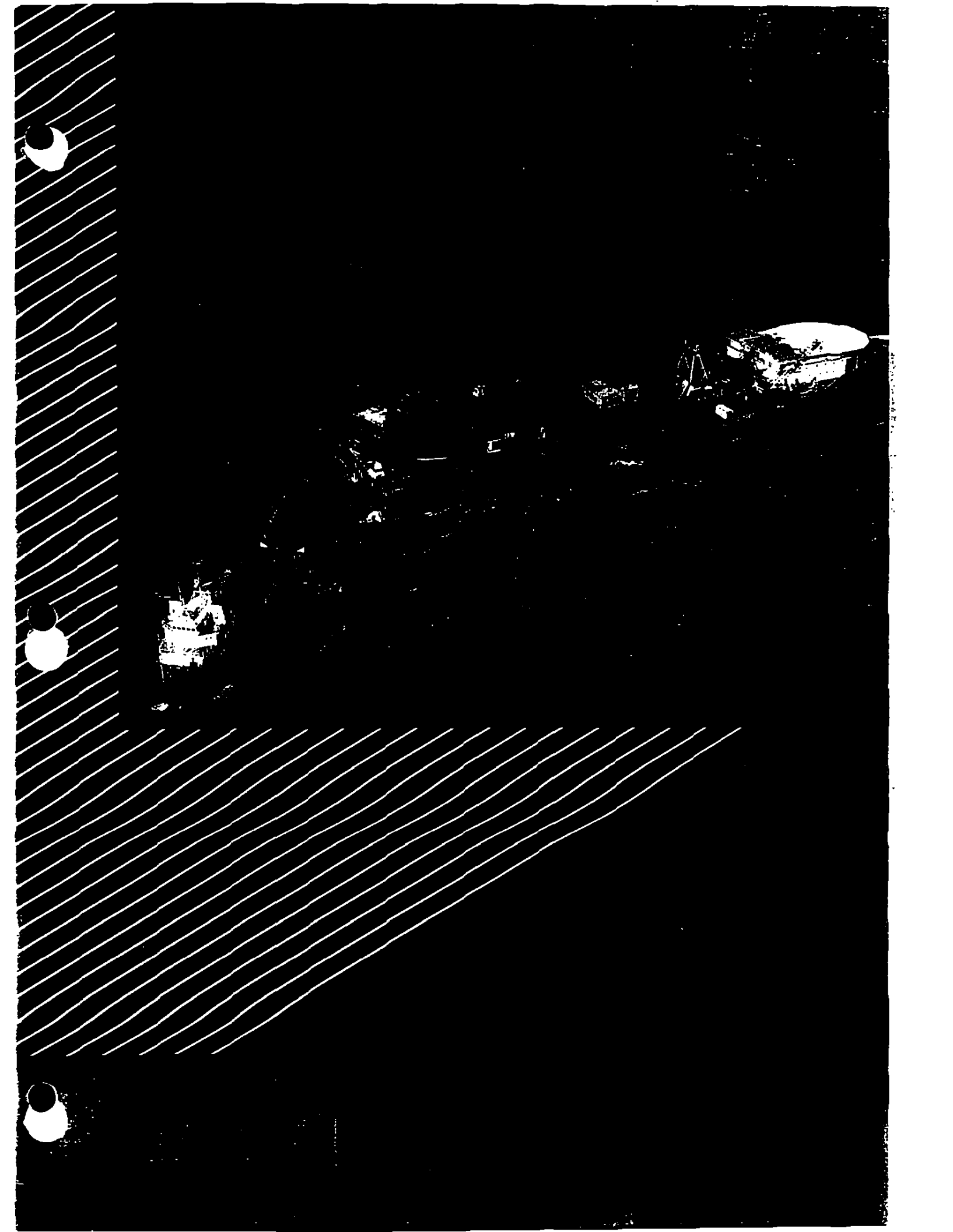

Derrick Barge 51 is a crane vessel with auxiliary propulsion for anchor and transit assist and capable of worldwide operation in a variety of marine construction roles. A mono-hull with a square stern and a ship-type bow, the vessel is equipped with a stern-mounted heavy-lift revolving crane. Maximum lift capacity is 2,700 short tons (2,449 metric) full revolving and 3,000 tons (2,721 metric) fixed over the stern.

The vessel is of welded steel construction, registered under the Panamanian flag, and is classed **A1 Barge** by the American Bureau of Shipping. Principal dimensions are 583.5 ft (178.2 m) by 140.4 ft (42.8 m) by 54.1 ft (16.48 m). Minimum draft is 28.1 ft (8.56 m), maximum draft is 39.4 ft (12.0 m).

DB 51 has approximately 29,365 ft² (2,728 m²) of available deck space with a loading capacity of 1.02 tons/ft² (10 metric tons/m²).

ACCOMMODATIONS

Living quarters on *DB 51* are equipped to accommodate 240 people. All quarters are centrally heated and air-conditioned and are located in the deck house near the bow of the vessel.

The barge has adequate mess, laundry and hospital facilities, and ample offices and conference rooms for customers. Lounge, cinema and game rooms are provided for off-duty personnel.

MOORING SYSTEM

The eight-point mooring system is composed of eight 33,075 lb (15,000 kg) Delta Flipper anchors, each with 8,000 ft (2,440 m) of 2 3/4-in (70 mm) diameter 6 x 41 l.W.R.C. wire rope on a double-drum Bodewes anchor hoist. Two hoists are located in the forward winch room and two aft. Hoists are powered by 500 HP electric motor.

The anchor hoists are controlled remotely from the aft bridge station, as well as from controls adjacent to each hoist. Closed circuit television provides constant monitoring of hoist drums from the winch control room.

In addition, two conventional ship's anchors with chain windlass and chain lockers are installed at the bow.

PROPULSION ASSIST SYSTEM

Three (3) electrically driven, 2,000 HP, azimuthing, fixed-pitch thrusters provide assistance for maneuvering and can be used while setting up anchors.

POWER GENERATION

Three (3) 1,800-kW 440-V, 60-Hz, 3-phase generators powered by MWM model TBD 441 V16 K diesel engines provide ample electrical power to the vessel.

Two diesel-powered auxiliary generators are tied in at the main switchboard and can operate in parallel with the main generators.

FIREFIGHTING AND SAFETY EQUIPMENT

The vessel carries a safety certificate and has on board all lifesaving equipment necessary to meet regulatory standards.

Special features include a fixed sprinkler system for accommodation corridors and cabins.

WATER/FUEL

Two evaporator plants can produce 55 tons (50 metric) of potable or fresh water per day.

Fuel and water storage is sufficient to allow continuous offshore service for up to 90 days without resupply.

WORKSHOP

Workshop facilities located aft below deck have adequate machine tools to facilitate repairs while the vessel is operating in remote locations.

NAVIGATION/ COMMUNICATION SYSTEMS

The vessel is equipped with a full complement of navigational instruments, including gyro compass, which is interfaced with the automatic pilot/steering control system for the auxiliary propulsion system.

Instant worldwide communications are available for client representatives. The vessel has radio communications including SSB, FM, VHF, and HF. Telephone, telex, and facsimile services are provided by satellite communications, and cellular telephones are shore-supported.

DIVING EQUIPMENT

A wide range of equipment can be located on the barge to support conventional air, surface mixed gas, and saturation diving as required for subsea installations.

HELIPORT

DB 51 is equipped with a heliport facility designed to service Sikorsky S-61 N aircraft and is complete with traffic control, and arrival and departure lounges.

The helideck complies with British Civil Aviation Authority (CAA) and A.B.S. regulations.

CONSTRUCTION EQUIPMENT

A. Main Revolving Crane

The vessel is outfitted with a Model M-3000 Amclyde (American) revolving crane.

Main Block

Full revolving

2,700 short tons at 105 ft radius
(2,449 metric tons at 32 m radius)

Fixed (over stern)

3,000 short tons at 105 ft radius
(2,721 metric tons at 32 m radius)

Auxiliary Block

Full Revolving

480 short tons at 200 ft radius
(435 metric tons at 61 m radius)

Whip Block

Full Revolving

75 short tons at 340 ft radius
(68 metric tons at 104 ft radius)

B. Deck Crane

A heavy-lift crawler crane supports anchoring and main deck operations.

C. Pile Driving

The barge is outfitted with three (3) Bronswerk-Amersfoort diesel-fired boilers capable of producing 64,680 lb (29,400 kg) of steam per hour at 203 psi (142.760 kg/m²).

Boiler capacity is sufficient to operate pile driving hammers as large as a Vulcan 5150.

Underwater hydraulic equipment is also available in support of subsea operations.

Pipelaying Facilities

While *DB 51* is not currently equipped for pipelaying, a complete complement of pipelaying equipment can be made available to it as required.

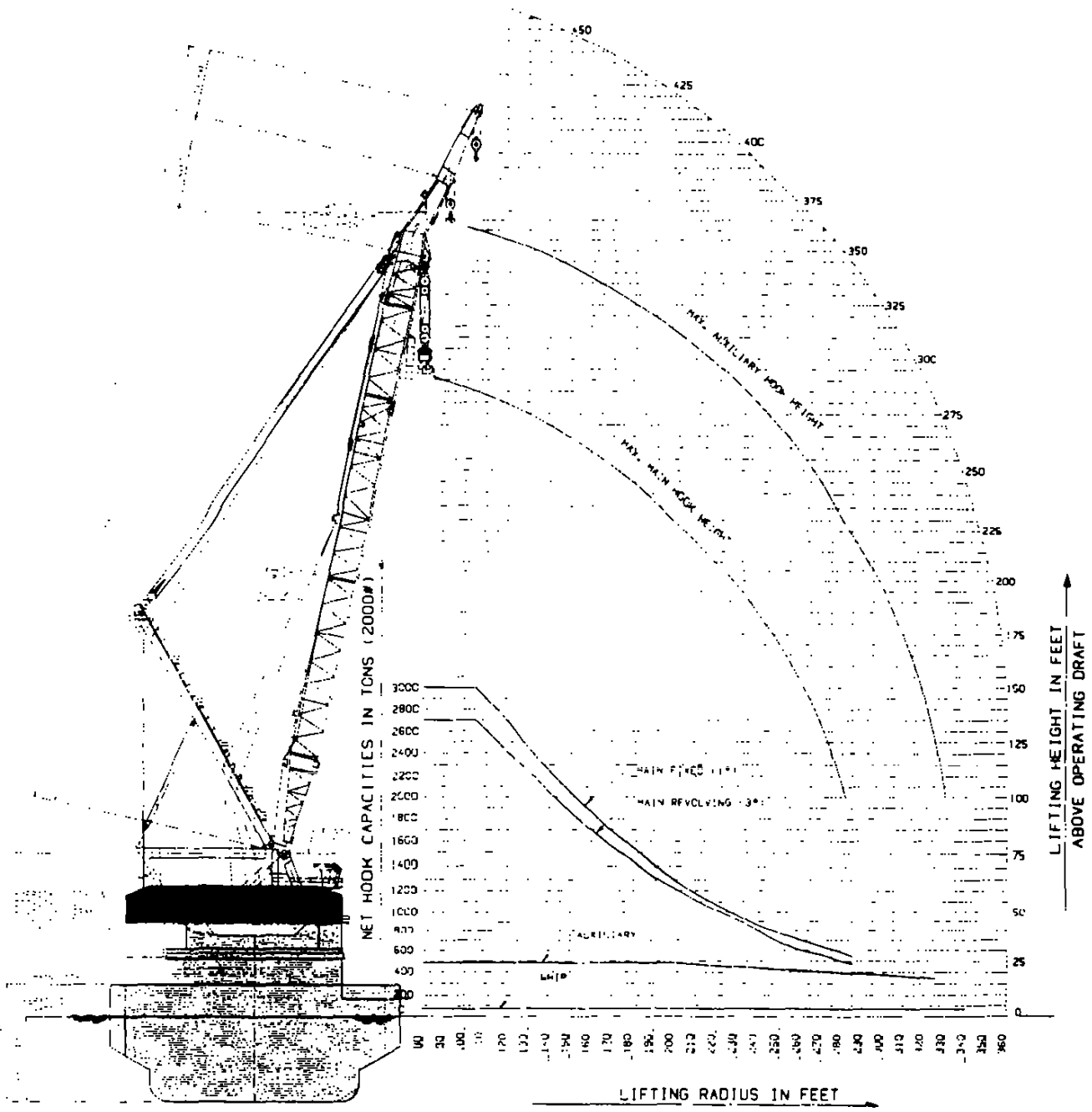

McDERMOTT DERRICK BARGE 51

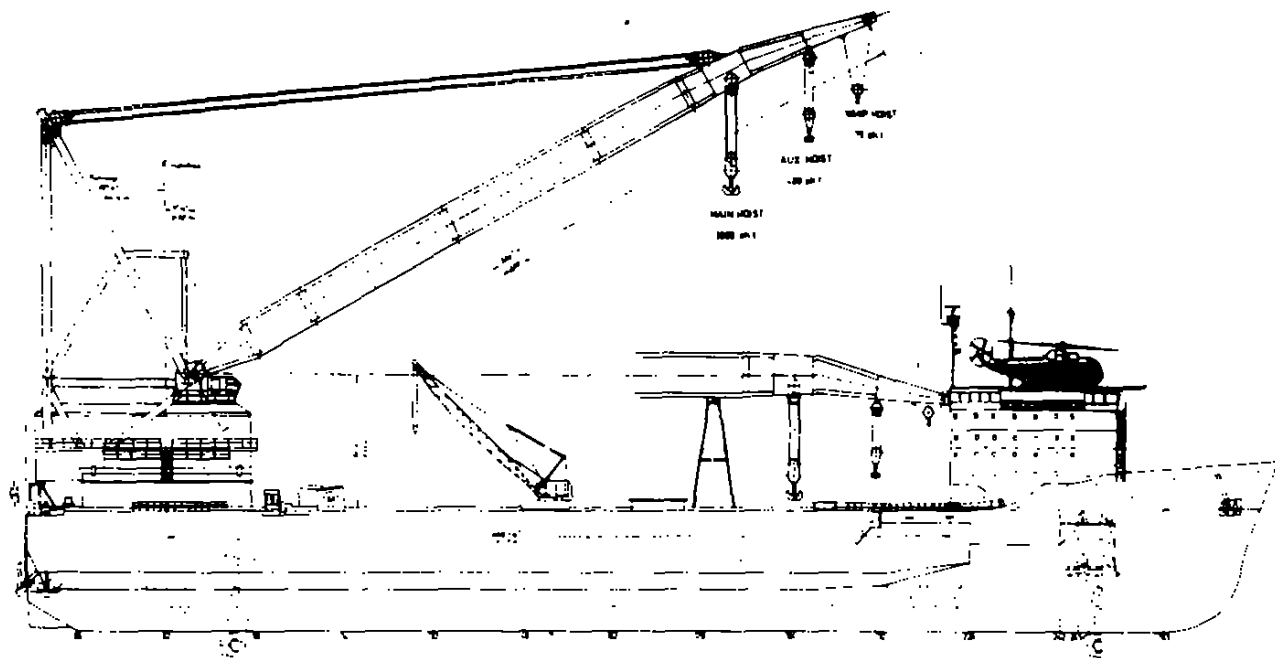



McDERMOTT MARINE CONSTRUCTION

Corporate Headquarters
1010 Common Street
New Orleans, Louisiana 70112
U.S.A.
Phone: (504) 587-5400
Telecopy: (504) 587-6153
Telex: 586-7412 (U.S.)
26-7079 (International)

North and Central America Operations

Offshore Division
P. O. Box 188
Morgan City, Louisiana 70381
U.S.A.
Phone: (504) 631-2561
Telecopy: (504) 631-8205
Telex: 293322 MCBFUR

Exhibit VIII-B

*Crowley Tugboat
Specification Sheet*

SEA RACER-CLASS TUGBOATS * DARING-CLASS TUGBOATS

*DARING	1965	SEA MONARCH	1966
*SEA LION	1965	SEA RACER	1966
*SEA WOLF	1965	VIGILANT	1966
SAMSON	1966		

*Daring-class tugs are powered by EMD 16 645 D5 engines rated at 2,800 horsepower. The more powerful E5 engines in Sea Racer-class tugs develop 3,500 horsepower.

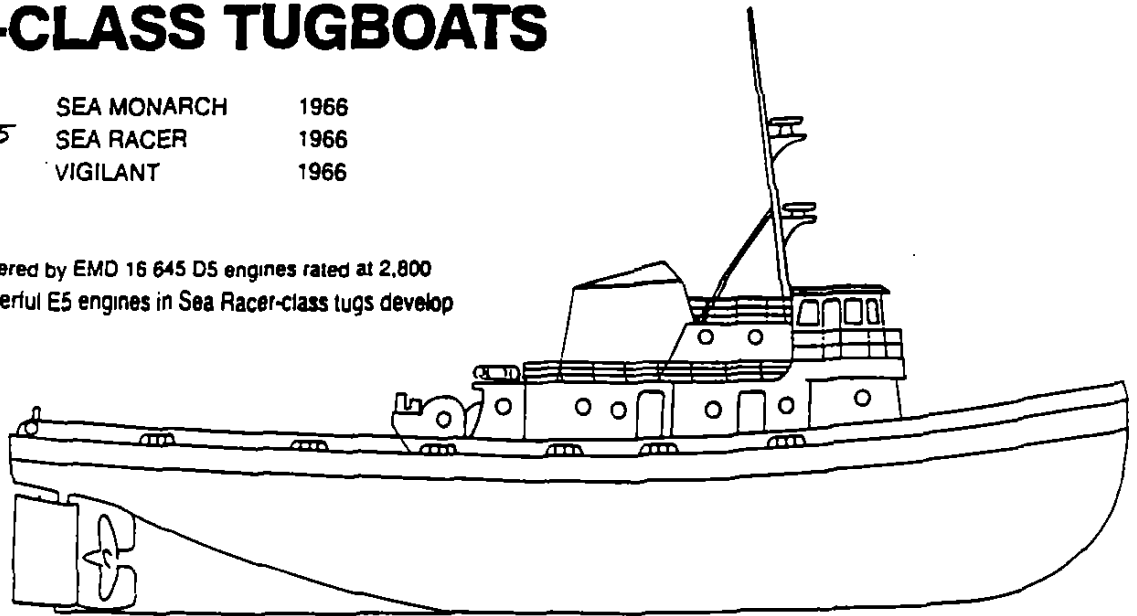

SEA RACER: SPECIFICATIONS

FLAG
United States

PORT OF REGISTRY
San Francisco, California

OFFICIAL NUMBER
504 166

CALL SIGN
WX 6371

BUILDER
Paceco, Alameda, CA

OVERALL DIMENSIONS
length, 121' 5";
breadth, 32';
depth, 17'

TONNAGE
199 tons gross;
93 tons net

CONSTRUCTION
Steel

LIGHT DRAFT
14 feet

LOADED DRAFT
16 feet

FUEL CAPACITY
100,000 gallons

POTABLE WATER
18,000 gallons

LUBE OIL
2,200 gallons

MAIN ENGINE
1 EMD 16 645 E5

AUXILIARY ENGINES
2 Caterpillar D333

PROPELLERS
Single screw, 5-bladed,
stainless steel

HORSEPOWER
3,500

REDUCTION GEAR
Falk, ratio 4.536:1

TOWING WINCH
Markey, double-drum

TOWING WIRE
2 @ 2200 feet of 2-inch
wire rope

NAVIGATION/COMMUNICATION EQUIPMENT

Radar — 2 Furuno
Loran — Northstar 6000
Satellite Navigator —
Navidyne ESZ 4000
VHF — 2 Modar Triton
55/75
SSB — Modar Triton 20,
CAI

Crowley Maritime Corporation's tug and barge fleet of some 450 vessels includes ocean tugs to 9,000 horsepower, harbor/river tugs, oceangoing deck barges to 730 feet in length with three decks (the world's largest RO/RO barges), harbor/river deck barges, covered barges, and oil barges to 16,200-dwt (long ton) capacity. In addition, the company operates a fleet of more than two dozen ships serving in the Caribbean, Central American, South American, European, and Far Eastern trades.



CROWLEY MARITIME CORPORATION

101 California Street, San Francisco, CA 94111

Exhibit VIII-C

Crowley Transportation Barge

400' x 99'-6 x 20'

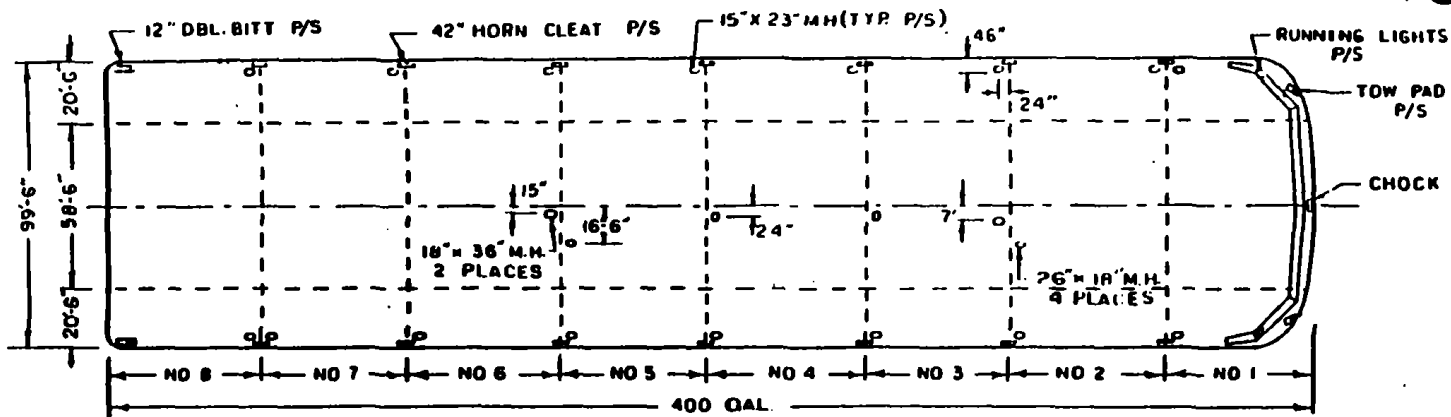

PLAN

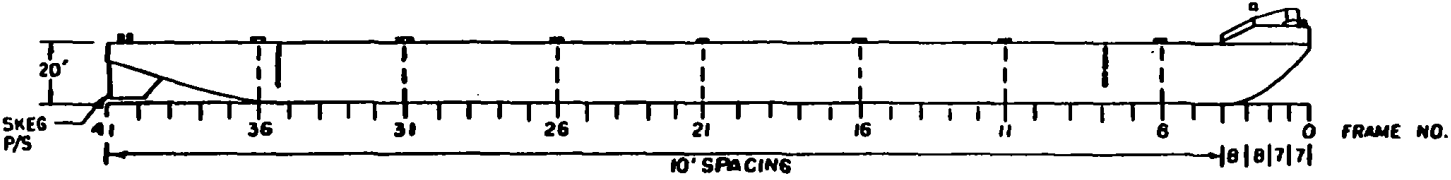

PROFILE

NOTES

- 1) MANWAYS IN ALL TANKS ARE OPEN. (P/S LONGITUDINAL BKHDS.)
- 2) 6 PCS. - 3"x 2"x 10' FLATBAR ALONG STERN FOR BARGE RAMP.

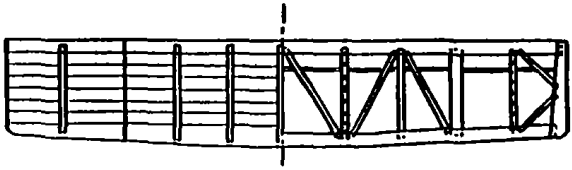

TYP SECTION

TANK CAPACITIES (FULL BREADTH)		
TANK	GALLONS	S.T.S.W
NO. 1	604,168	2585
NO. 2-7	744,359	3,104
NO. 8	528,495	2,261

ARCTIC MARINE FREIGHTERS
 400' x 100' x 20'
OUTFITTING LAYOUT
BARGE ST THOMAS
 DATE 3-30-84 | REV 0

Exhibit VIII-D

Tidelands 'O' Series Barge

240' x 72' x 17'-3

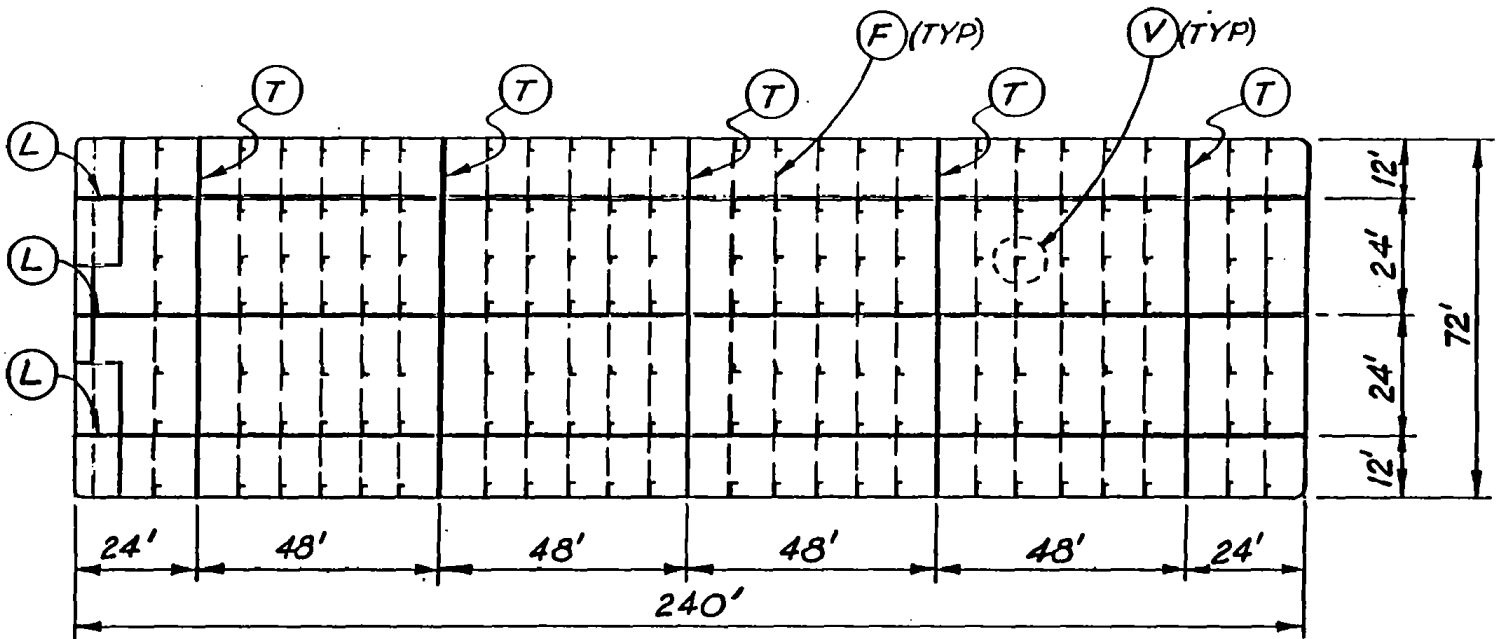

TIDELANDS 020

1" = 30'-0"

DECK PL $\frac{5}{8}$ "
 DECK LONGLS L7"x4"x $\frac{3}{8}$ " (24" c/c)

(L) LONGL BHD'S $\frac{1}{2}$ " PL (TOP 30")
 $\frac{3}{8}$ " PL REMAINDER

HORIZ FRMD { 3 UPPER BHD LONGLS L6"x3 $\frac{1}{2}$ "x $\frac{1}{4}$ "
 3 MID BHD LONGLS L6"x3 $\frac{1}{2}$ "x $\frac{5}{16}$ "
 2 LOWER BHD LONGLS L6"x3 $\frac{1}{2}$ "x $\frac{3}{8}$ "

(T) TRANSV BHD $\frac{1}{2}$ " PL (TOP 30")
 $\frac{3}{8}$ " PL REMAINDER
 VERT BHD STIFFS L8"x4"x $\frac{3}{16}$ " (24" c/c)
 (F) TRANSV FRAME 21"x4 $\frac{1}{2}$ "x $\frac{9}{16}$ " FLG PL
 W/7" NOTCHES
 (V) VERTICAL STANCHION L8"x8"x $\frac{3}{4}$ "
 VERT WEB FRAME 18"x4 $\frac{1}{2}$ "x $\frac{3}{16}$ " FLG PL

TIDELANDS 020
 12/8/88
 1/8

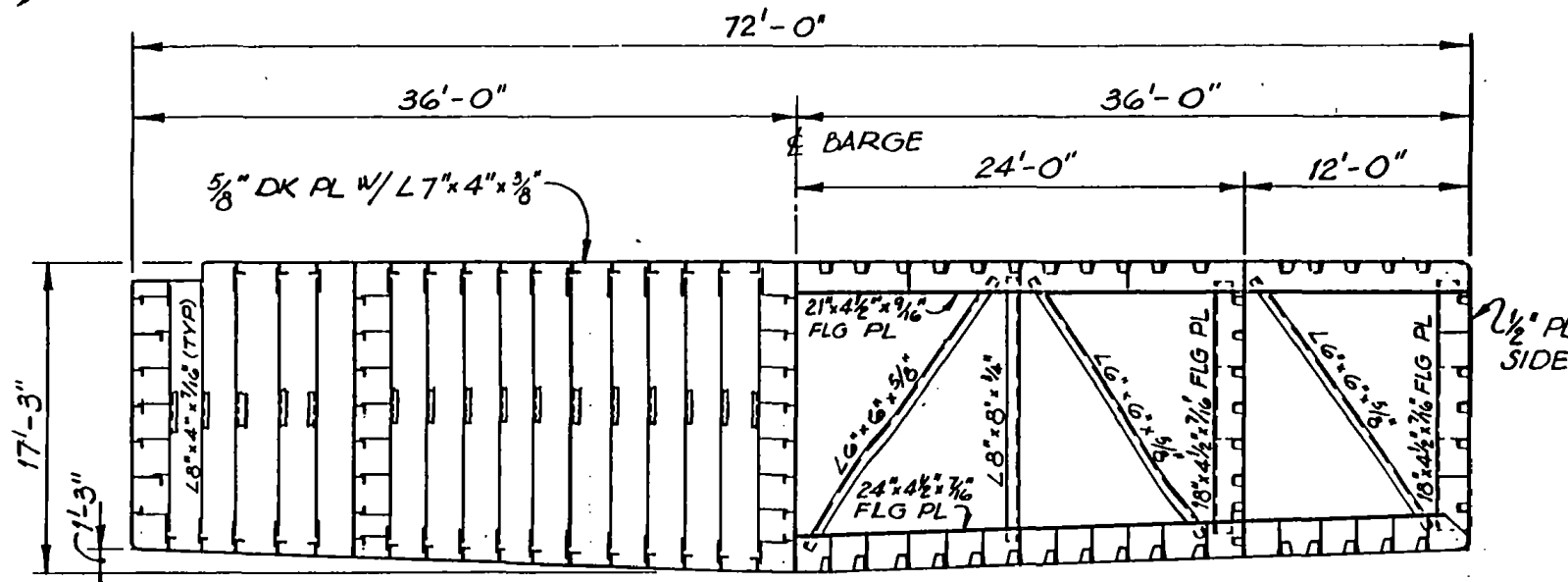

TYPICAL TRANSV W.T. BHD
LOOKING FWD

TYPICAL TRANSV FRAME
LOOKING FWD

TYPICAL MIDSHIP SECTION

TIDELANDS 020

$$\frac{1}{8}'' = 1'-0''$$

TIDELANDS 02C
 12/8/88 JS

Exhibit VIII-E

Jaramac 69

Information Sheet

**Jaramac 68 and Jaramac 69
Outline Specifications**

Dimensions:	Length O.A.L.	205'
	Beam Moulded	42'
	Depth	16'6"
Hull Materials:	Main Deck	5/16" x 3/8" plate
	Side Plating	1/2"
	Bottom Plating	1/2"
	Bulkhead	1/4" x 3/8" plate
	Shear Strake	1" x 4'8"
Gross Tonnage:	Under 300	
Class:	ABS + A-1, +AMS Ocean Supply,	
Certificates:	United States Coast Guard/American Bureau of Shipping - Hull & Machinery	
Approximate Capacity:	Fuel Oil	123,751 gallons
	Ballast Water	304,314 gallons
	Potable Water	18,506 gallons
	Deck Cargo	500 L. tons
	Bulk Material	4,000 cu. ft.
	Liquid Mud	1,083 barrels
Engine:	Two (2) EMD 16645 E7BA	
Horsepower:	6140 BHP	
Propellers:	120" x 89" 4-blade stainless steel	
Accommodations:	20 men	

IX. ANCHOR PLANS

The DB 51 will be anchored at Platform Harmony and Platform Heritage before commencing with the topsides installation. The eight-point anchoring system is designed to keep the derrick barge stationary during lifting activities. The typical anchoring system for the DB 51 (See Exhibit IX-A) consists of a 33,000 pound anchor, an anchor cable, a pendant line, and a buoy.

McDermott anticipates using Meridian Ocean Surveys (MOS) of Ventura to provide survey support for proper placement of the anchors. Based on the use of MOS, an integrated navigation system (MOSNAV) will be installed on the anchor handling vessel and on the derrick barge. This system will provide a real time display of the vessels' position with respect to the existing platforms, pipelines, power cables, and anchor locations. A Motorola Mini-Ranger surface navigation network will provide input to the MOSNAV system to determine the current locations of the derrick barge and anchor handling vessel within 3 meters.

As the DB 51 approaches the Harmony worksite from the west, it will be guided over the first anchor location by the tow vessel. It will then vertically lower and set its first anchor within the target zone while monitoring its location, and the coordinates will be stored by the MOSNAV system and graphically displayed. The tow tug will continue towing the DB 51 to a position near the jacket where it will release the tow bridle to install the remaining seven anchors.

The anchor handling tug (tow tug) will attach a pendant wire to an anchor and the barge crane will lift it from the derrick barge and set it into the water directly behind the anchor handling tug. The tug will then take directions from the derrick barge superintendent and surveyors to move towards the proper anchor set down point. Extreme care will be taken to avoid possible cultural resources by at least 300 ft and any pipelines and power cables in the area by at least 500 ft. When the anchor handling tug is in position as established, the anchor will be vertically lowered to the sea bottom and the buoy attached to the pendant

wire will be released to mark the location of the anchor. The tug will return to the derrick barge to receive the next anchor.

Exhibits IX-B and IX-C show the anchoring plans at Harmony and Heritage Platforms. The anchor plans are within the general footprint of those approved for 1989-90 jacket installation. Anchor patterns for topsides installation were selected to optimize lift procedures by the DB 51, while avoiding the potential cultural resource site and pipelines and power cables. Each anchor target zone is approximately 18 acres (500-ft radius around planned drop locations). The anchor target zone nearest the potential cultural resource site is over 3500 ft away. In addition, the target zones avoid unidentified sonar targets recorded from previous surveys. As stated in Section 5.1, there is no known hard bottom habitat near Harmony or Heritage.

To retrieve an anchor, the anchor handling tug will approach the anchor's buoy, attach to the pendant line, and vertically raise the anchor to its stern. Then, the DB 51 will pull the anchor cable in while the anchor handling tug keeps tension on the cable. When the anchor handling tug nears the DB 51, the barge crane will take the anchor from the tug and place it on the derrick barge deck as the rest of the anchor cable is reeled in.

Exhibit IX-A

Typical Anchoring System

EXHIBIT IX-A

TYPICAL ANCHORING SYSTEM

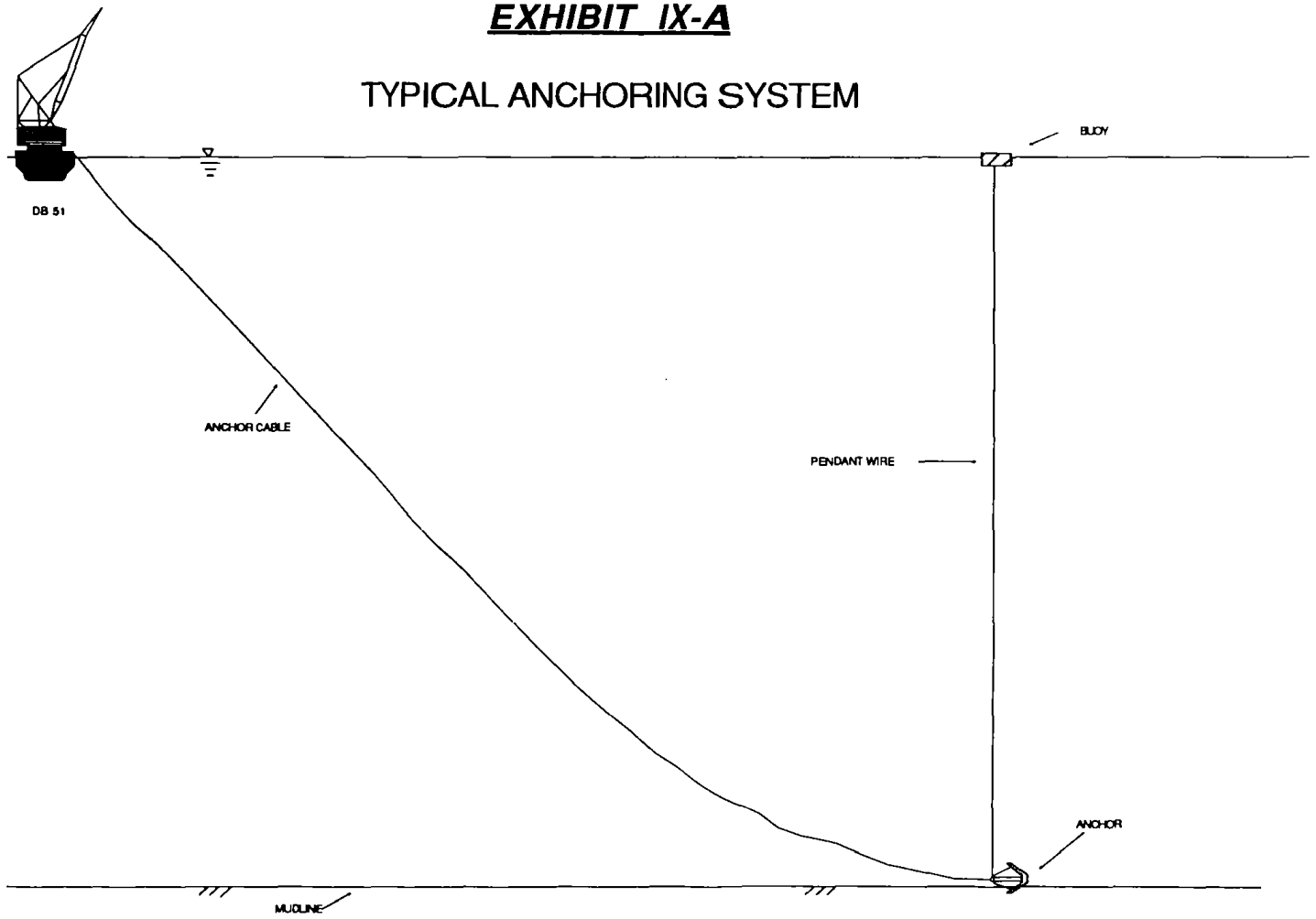
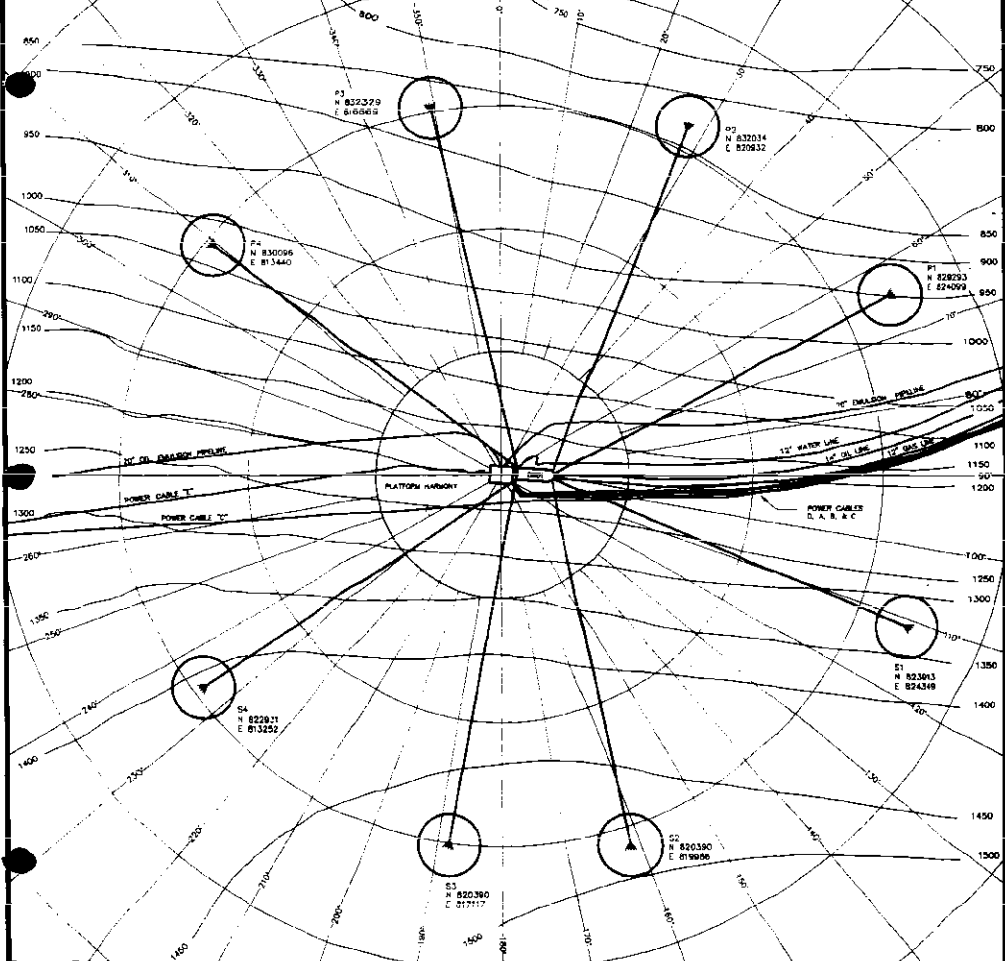

Exhibit IX-B

Typical Anchoring Plan

at

Harmony Platform



LINE ANCHOR	BEARING FROM PLATFORM TO ANCHOR	DISTANCE FROM PLATFORM TO ANCHOR	LENGTH FROM ANCHOR TO FAIRLEAD
S1	111° 02' 32"	6826'	6000'
S2	161° 25' 27"	6303'	6000'
S3	188° 12' 17"	6036'	6000'
S4	234° 00' 21"	5841'	6000'
P1	06° 25' 31"	6786'	6000'
P2	027° 31' 10"	6394'	6000'
P3	349° 27' 54"	6065'	6000'
P4	309° 25' 48"	5876'	6000'

PROPOSED ANCHOR LOCATION
 950 BATHYMETRY CONTOURS AT 50 FT. INTERVALS
 EXISTING PIPELINES AND POWER CABLES

WATERDEPTH: -1200' (366m) AT PLATFORM LOCATION
 LOCATION/BLOCK NO.: SANTA YNEZ AREA/33N 75W
 COORDINATES: 34° 22' 34" N (Y=835864)
 120° 10' 03" W (X=817878)

PIPELINE LOCATIONS ARE FROM JOHN E. CHANCE ASSOCIATES AS BUILT DRAWINGS (APRIL, 1992).
 CONTOURS DRAWN FROM WOODWARD-CLOKE CONSULTANTS DATA BASE MAP, BATHYMETRY AND SURFICIAL FEATURES PLATE 4 DATED JUNE 1991.

REVISIONS

NO.	DATE	DESCRIPTION	BY
1	5-18-92	PIPELINE AS BUILT LOCATIONS ADDED	DES
2	5-27-92	ADDED ANCHOR LOCATIONS	JJC

McDERMOTT MARINE CONSTRUCTION
EXXON SYU PROJECT
ANCHORPLAN FOR PLATFORM HARMONY
MODULE INSTALLATION

MERIDIAN OCEAN SURVEYS			
4064 Market Street, Ventura, California 93003			
DATE:	JOB No.:	DRAWING No.:	DRAWN BY:
MAY 18, 1992	OY-0855	800-2	DES

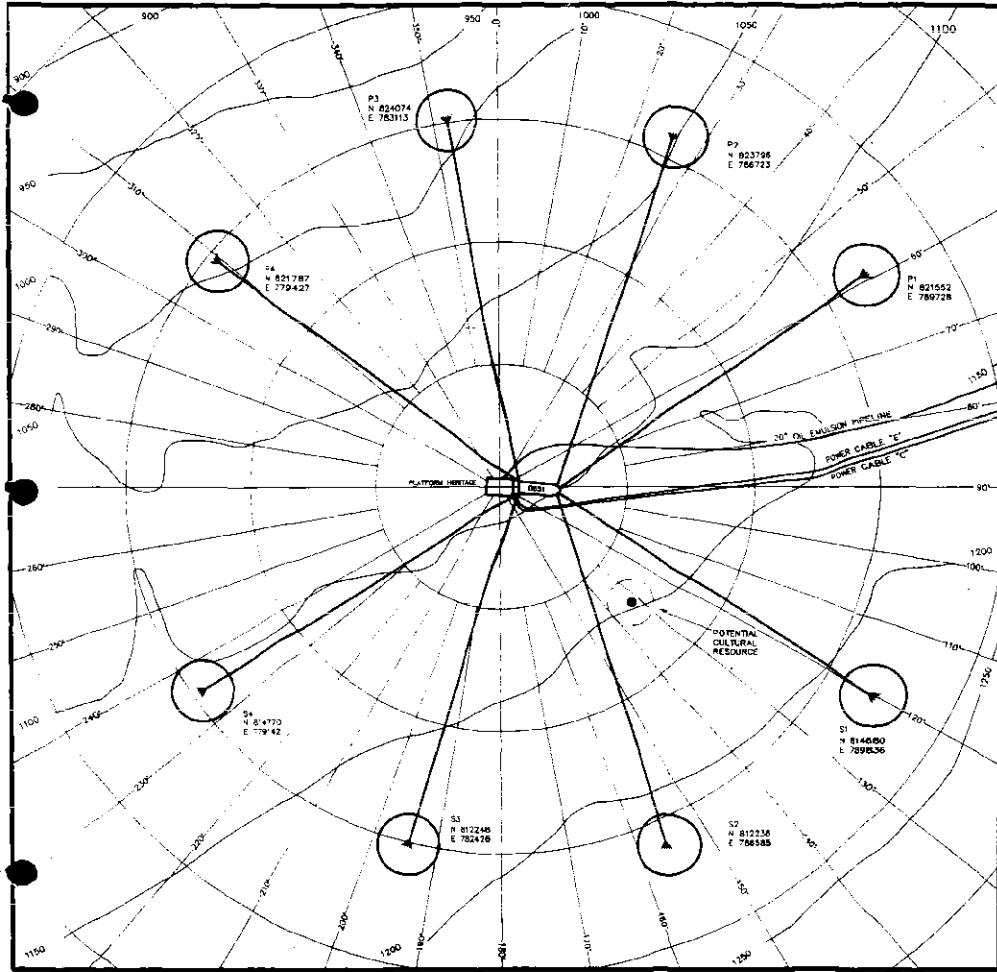

Exhibit IX-C

Typical Anchoring Plan

at

Heritage Platform



LINE ANCHOR	BEARING FROM PLATFORM TO ANCHOR	DISTANCE FROM PLATFORM TO ANCHOR	LENGTH FROM ANCHOR TO TABLEAD
S1	120° 00' 58"	6815'	6000'
S2	155° 38' 22"	6425'	6000'
S3	94° 29' 12"	6032'	6000'
S4	235° 18' 06"	5830'	6000'
P1	059° 07' 50"	6748'	6000'
P2	026° 02' 22"	6351'	6000'
P3	352° 11' 04"	6042'	6000'
P4	309° 21' 42"	5831'	6000'

PROPOSED ANCHOR LOCATION
 BATHYMETRY CONTOURS AT 50 FT. INTERVALS
 EXISTING PIPELINES AND POWER CABLES
 POTENTIAL CULTURAL RESOURCE
 DIAMETER = 180 FT HEIGHT 16 FT
 COORDINATES : 34° 23' 44" N (N=816200)
 120° 16' 20" W (W=786500)
 CLEAR AREA AROUND POTENTIAL CULTURAL RESOURCE DIAMETER = 780 FT.
 WATERDEPTH : ~1070 (328m) AT PLATFORM LOCATION
 LOCATION/BLOCK NO. SANTA YNEZ AREA/S2N 77W
 COORDINATES : 34° 21' 07" N (N=816088)
 120° 18' 45" W (W=785925)
 CONTOURS DRAWN FROM WOODWARD-CLYDE CONSULTANTS
 DATA BASE MAP, BATHYMETRY AND SUPPLEMENTAL FEATURES
 PLATE 7 DATED JUNE 1991
 PIPELINES ARE FROM JOHN E. CHANCE AS BUILT DRAWING
 (APRIL, 1992)

PLATFORM NORTH
 4-8' GRID

REVISIONS			
NO.	DATE	DESCRIPTION	BY
1	5-18-92	MODIFIED PIPELINE LOCATIONS	JLR
2	5-28-92	ADDED ANCHOR LOCATIONS	JAG

SCALE 1"=1000 FT.

McDERMOTT MARINE CONSTRUCTION

**EXXON SYU PROJECT
ANCHORPLAN FOR PLATFORM HERITAGE
MODULE INSTALLATION**

MERIDIAN OCEAN SURVEYS
4864 Market Street, Ventura, California 93003

DATE: MAY 19, 1992	JOB No.: OY-0855	DRAWING No.: 858-1	DRAWN BY: DES
-----------------------	---------------------	-----------------------	------------------



SYU EXPANSION PROJECT
PRE-HOOKUP EXECUTION PLAN
FOR THE HARMONY & HERITAGE PLATFORMS

June 15, 1992

1. INTRODUCTION

This Pre-hookup Execution Plan describes the platform hookup activities that will be conducted while the derrick barge DB 51 is present for module installation at the Harmony & Heritage Platforms.

In 1989, Exxon contracted with Gulf Marine Fabricators (GMF) for the construction of the topsides modules for the Harmony & Heritage platforms. This contract includes the onshore outfitting of the Modules in Aransas Pass Texas, and the offshore hookup of the Modules following transportation to the West Coast and Installation by McDermott International.

Pre-hookup work is conducted from the installation derrick barge in parallel with the installation process and comprises those activities that need to be completed to make the platforms safe for occupancy of the quarters, and those activities that are necessary to accelerate the energization of shore power.

Hookup comprises all the remaining work necessary to complete construction of the platforms for drilling.

This Execution Plan describes the pre-hookup work. Hookup will be described in a separate Execution Plan to be provided at a later date.

This document is intended to be representative of the work activities only, and field execution may deviate from plans based on actual conditions and any unanticipated events.

2. SCOPE OF WORK

Those activities listed below will be conducted during pre-hookup and are additional to module installation activities being conducted by McDermott:

Piping Work:

Install piping closure spools to allow commissioning and startup of essential utilities and systems such as, potable and utility water, sewage, deck drains, diesel fuel, firewater, and compressed air.

Electrical Work:

Install inter-modular power and control cables and bus duct splices to allow energization of shore power and critical portions of the 35KV, 4.2KV, 480V, and un-interruptible power systems to allow power distribution to the above mentioned essential utilities, as well as the quarters, lighting, navigation aids, life floats & life rafts, fire alarm, and communications.

Commissioning and Startup Work:

Commission & Startup of above mentioned systems to allow safe occupation of the Platforms & Quarters.

For safety reasons, these activities will be conducted between module installation lifts. For example, when McDermott completes a Module lift, and sends their welding crew aboard the platform to weld-out the major module interfaces, a crew will also go onto the platform to conduct pre-hookup activities, until the next lift is ready to be made.

3. SCHEDULE

Pre-hookup work will begin shortly after the derrick barge arrives and is anchored at the site and will conclude just prior to the derrick barge release from the respective platform. When the derrick barge completes module installation at Harmony, hookup at Harmony will commence, and preparation for pre-hookup at Heritage will begin. (See attached schedule)

4. IN-PLACE CONTRACTING

The offshore hookup scope was included in the module construction contract awarded to GMF in 1989. GMF will perform the structural and piping work with their own employees and will bring these craftsmen to the West Coast from South Texas.

GMF subcontracted in 1989 all Electrical & Instrumentation work for Module Construction and Hookup to SECO. SECO will also bring most of their craftsmen from the Gulf Coast, but some will come from West Coast locations.

Electrical interconnection to the subsea power cables will continue to be done by Coflexip/Kerite, the subsea cable supplier/installer.

Exxon personnel will perform commissioning and startup activities with the assistance of specialty contractors.

5. LOGISTICAL SUPPORT

Pre-hookup personnel will be housed on the McDermott derrick barge DB-51. Personnel changeout will occur as frequently as weekly, and travel to shore will be by combination of crew boat and helicopter.

Most GMF and SECO personnel will travel to their home location on the Gulf Coast by commercial or charter flight.

Exxon personnel will mostly live locally in the Tri-County area and will travel to these locations by private vehicle.

Most materials and tools required for Pre-hookup will be stored on the Modules prior to loadout on the Gulf Coast.

Personnel travelling offshore by boat will utilize the Exxon parking lot and van service in Goleta.

6. OVERALL STAFFING REQUIREMENTS

GMF/SECO/Coflexip pre-hookup staffing is expected to peak at thirty craft and supervisory personnel. Craft make-up will largely consist of pipe fitters and welders, electricians, and instrument technicians, as well as support laborers such as scaffolders.

Exxon staffing on the DB 51 is expected to peak at ten construction engineers/inspectors.

7. CONSTRUCTION EQUIPMENT

Pre-hookup work will be accomplished with light construction and hand tools, and supplemented with the derrick barge crane. Tools and light equipment would likely include:

Welding Machines	Generators
Cutting Torches	Air Compressors
Grinders	Air Tuggers
Chippers	Porta-Powers
Pipe Threaders	Hole Punches
Impact Wrenches	Drills
Heating Blankets	Portable A-Frame

In addition to the above, pipe welds will be inspected with radiography, and radiographic sources and associated film and photographic equipment will be present.

Electricity for pre-hookup will be furnished initially via temporary power cables from the DB 51 and supplemented later on from a temporary construction generator backed up by the platform standby generator.

HARMONY OR HERITAGE PRE-HOOKUP SCHEDULE

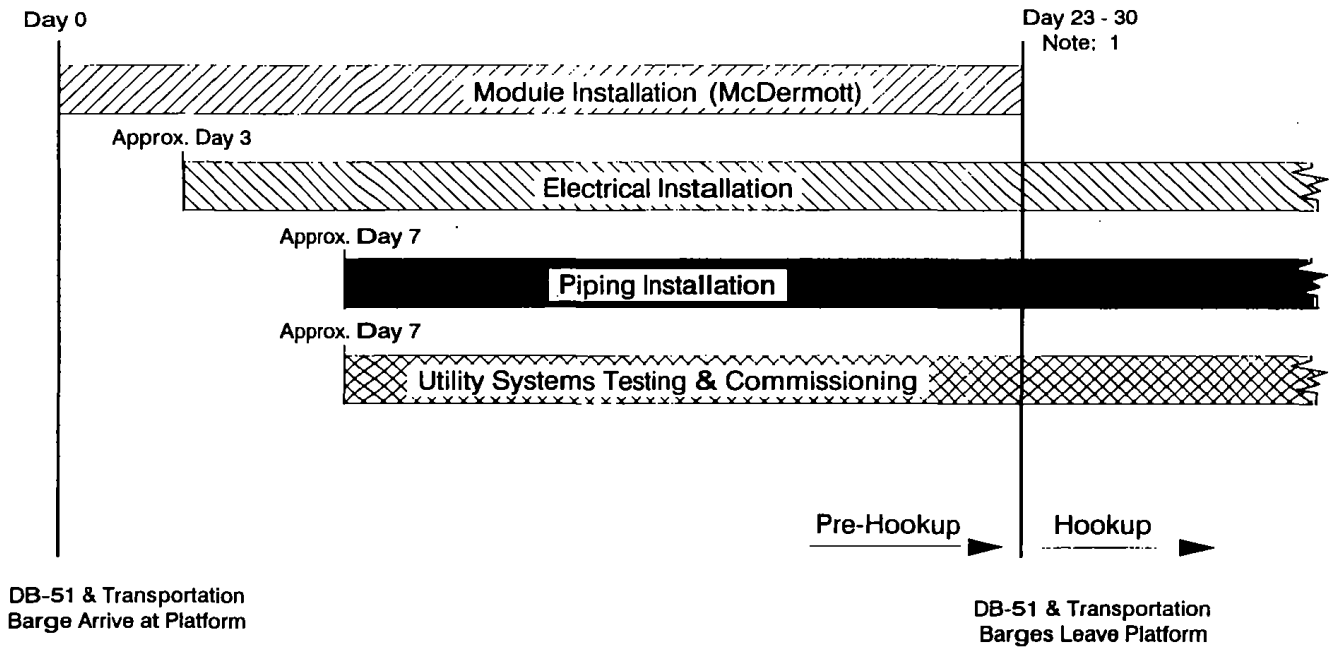

DB-51 & Transportation
Barge Arrive at Platform

DB-51 & Transportation
Barges Leave Platform

Note 1: Depending on weather.