

Preliminary Results of Application of Oil and Dispersed Oil on Drag on Bowhead Whale Baleen

Todd Sformo^{1*}, Gary Shigenaka², Craig George¹, Teri Rowles³, Michael Moore⁴, Tom Lanagan⁴, Geof Givens⁵ and Alexander Werth⁶

¹North Slope Borough/Department of Wildlife Management, Barrow, AK, ²NOAA/Office of Response and Restoration/Emergency Response Division, Seattle, WA, ³NOAA/National Marine Fisheries Service/Office of Protected Resources, Silver Spring, MD, ⁴Woods Hole Oceanographic Institution, Woods Hole, MA, ⁵Givens Statistical Solutions, ⁶Hampden-Sydney College, Hampden-Sydney, VA

Goal:

Assess the effects of Alaska North Slope crude oil and Corexit 9500A on baleen *via* drag

*todd.sformo@north-slope.org

Oil and Hazardous Materials Simulated Environmental Test Tank, Leonardo, New Jersey

Photo: [wikipedia.org/wiki/ Ohmsett#/media/File: Ohmsett_AerialOriginal_2-03.jpg](https://www.wikipedia.org/wiki/Ohmsett#/media/File:Ohmsett_AerialOriginal_2-03.jpg)



- *Balaena mysticetus* long-lived, large-bodied
- Inhabits arctic and sub-arctic waters—ice-associated cetacean
- Mainstay of food and cultural practices for the Inupiaq people of the North Slope
- Listed species
- Potential of fouling of baleen
 - Food Security
 - Oil contingency plans in the Arctic

- functional units of bowhead are the filter-feeding mechanisms are baleen

- 20 cm “hairs”
- Bristles create a high surface area
- Main Q: does crude oil cleave?



Braithwaite (1983)

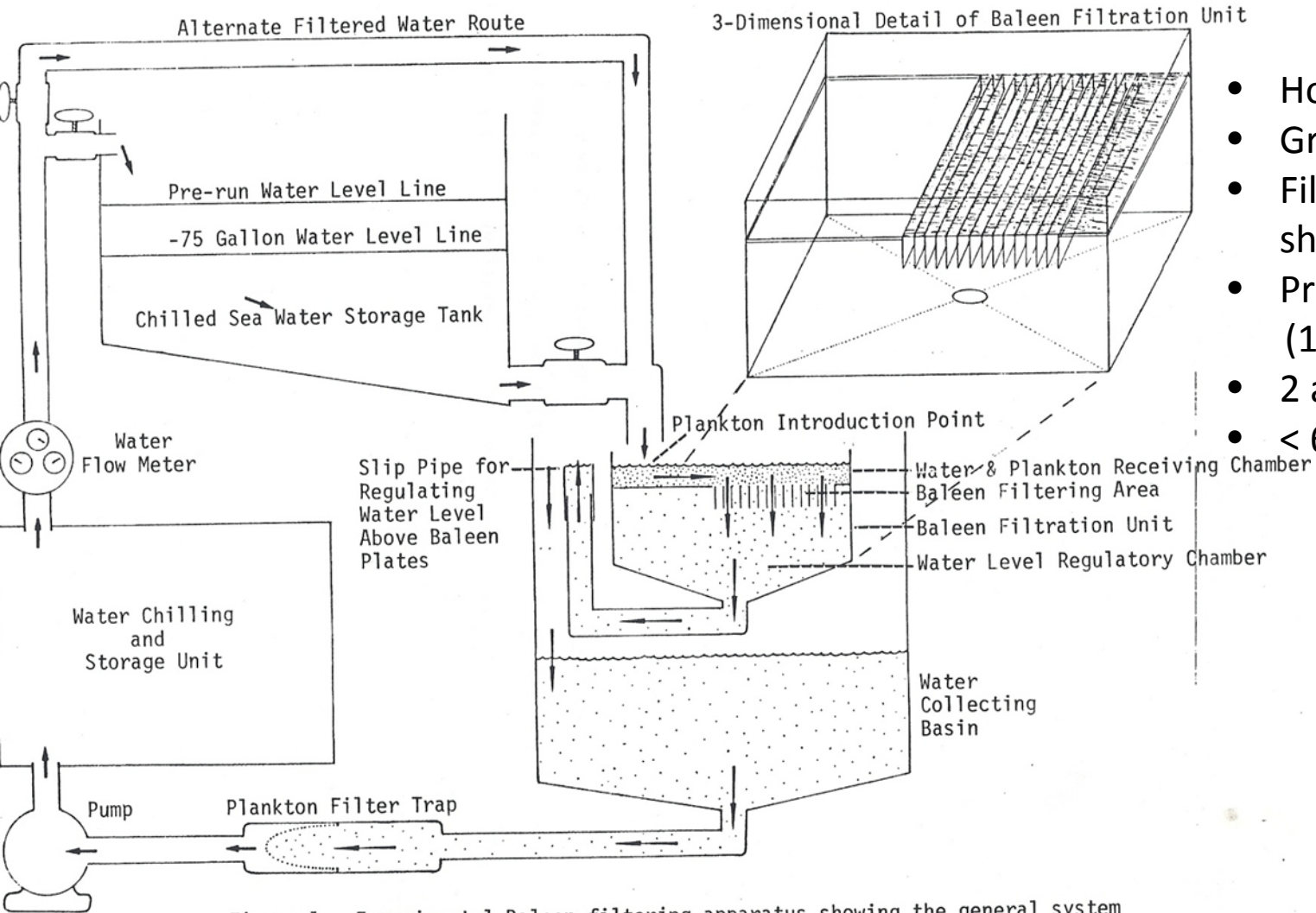

- Horizontally plates
- Gravity fed water
- Filtered brine shrimp
- Prudhoe Bay, 9527 (1-10mm fouling)
- 2 and 12 °C
- < 6-12%

Figure 1. Experimental Baleen filtering apparatus showing the general system components and directional routes of water flow.

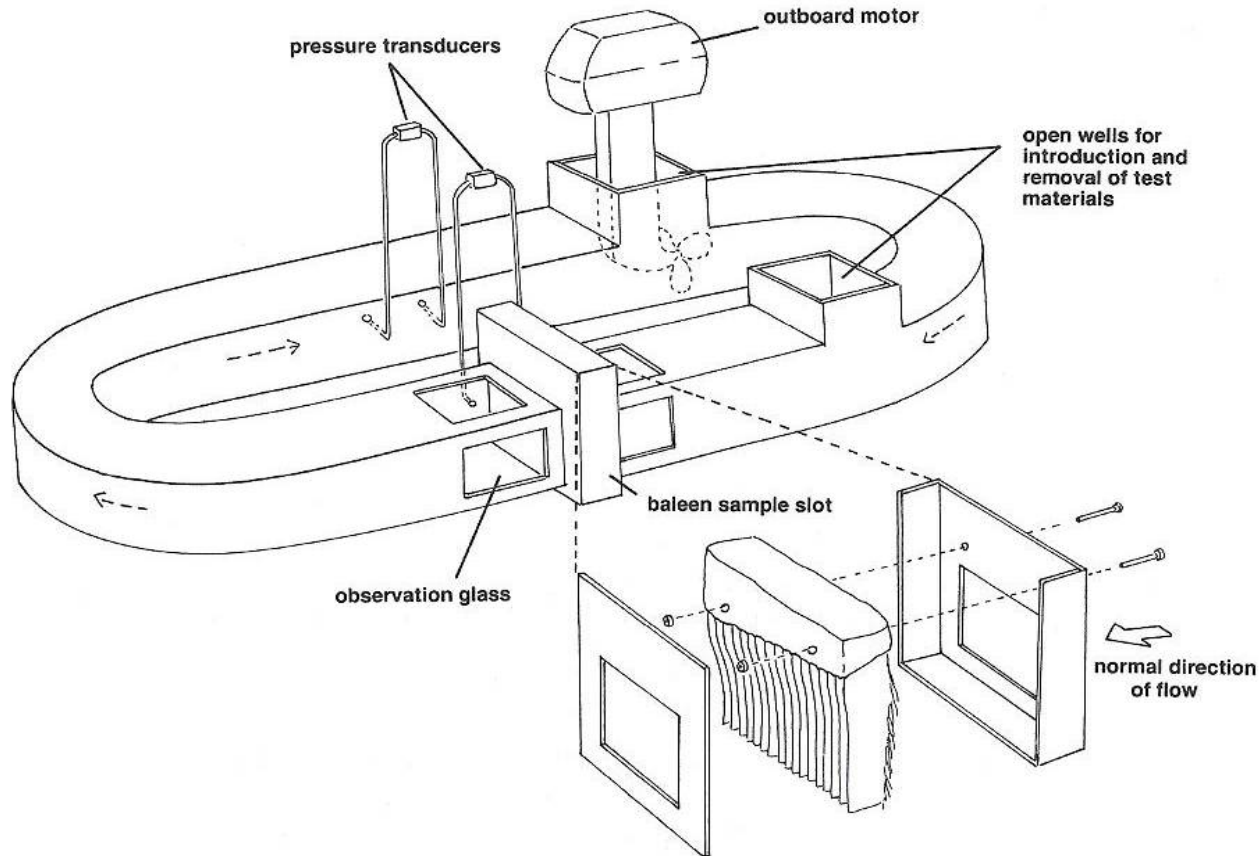

Figure 6-5

Tests were conducted in an elliptical tunnel with an outboard motor to circulate the water. Pressure transducers were positioned upstream and downstream from the baleen sample. Baleen specimens were mounted in a wooden frame for testing.

- Baleen from fin, gray, and humpback whale
- Bunker C oil
- resistance to flow [was] less than 75 % in fin and sei whale preparations. Gray whale samples were relatively unaffected

Methods & Materials



Oil and Hazardous Materials Simulated Environmental Test Tank, Leonardo, New Jersey

Methods & Materials



9 feet, 85 lbs., 15 plates



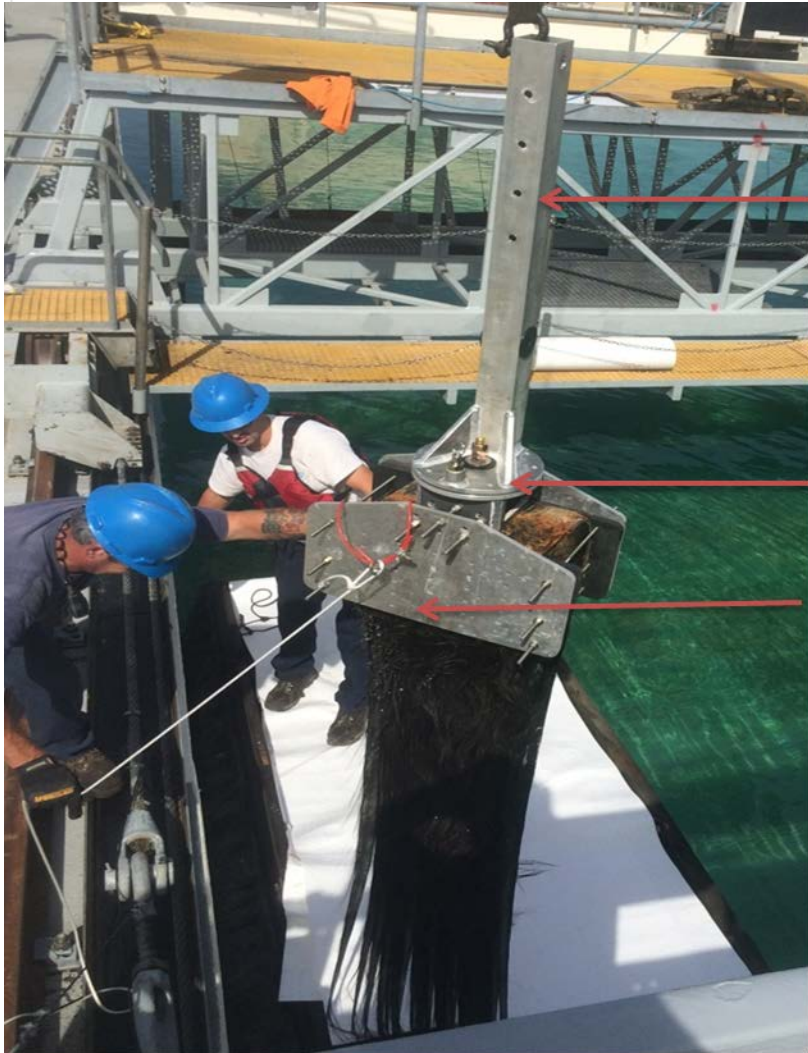

Lever arm

ATTACHMENT POINTS FOR LOADS

Turntable

Baleen clamp

ATTACHMENT POINT (FOR HEAD)

RING LOADED PULL POINT TO LOCK ROTATION

1/8" DEEP SOCKET WRENCH
 A POLE EXTENSION WILL ROTATE
 BALEEN MOUNT ONCE PULL PIN IS
 RELEASED WITH ATTACHED LINE



Approximately 5
 to 5.7' of baleen
 submerged

Baleen Mount (WHOI)

Recording Data

- LabView 10 Hz
- Load Cell: 100
- Bridges speed: 0.2 to 1.6 knots

Frontal Area calculation and sketch

- bowhead racks that vary in plate number, length, and orientation

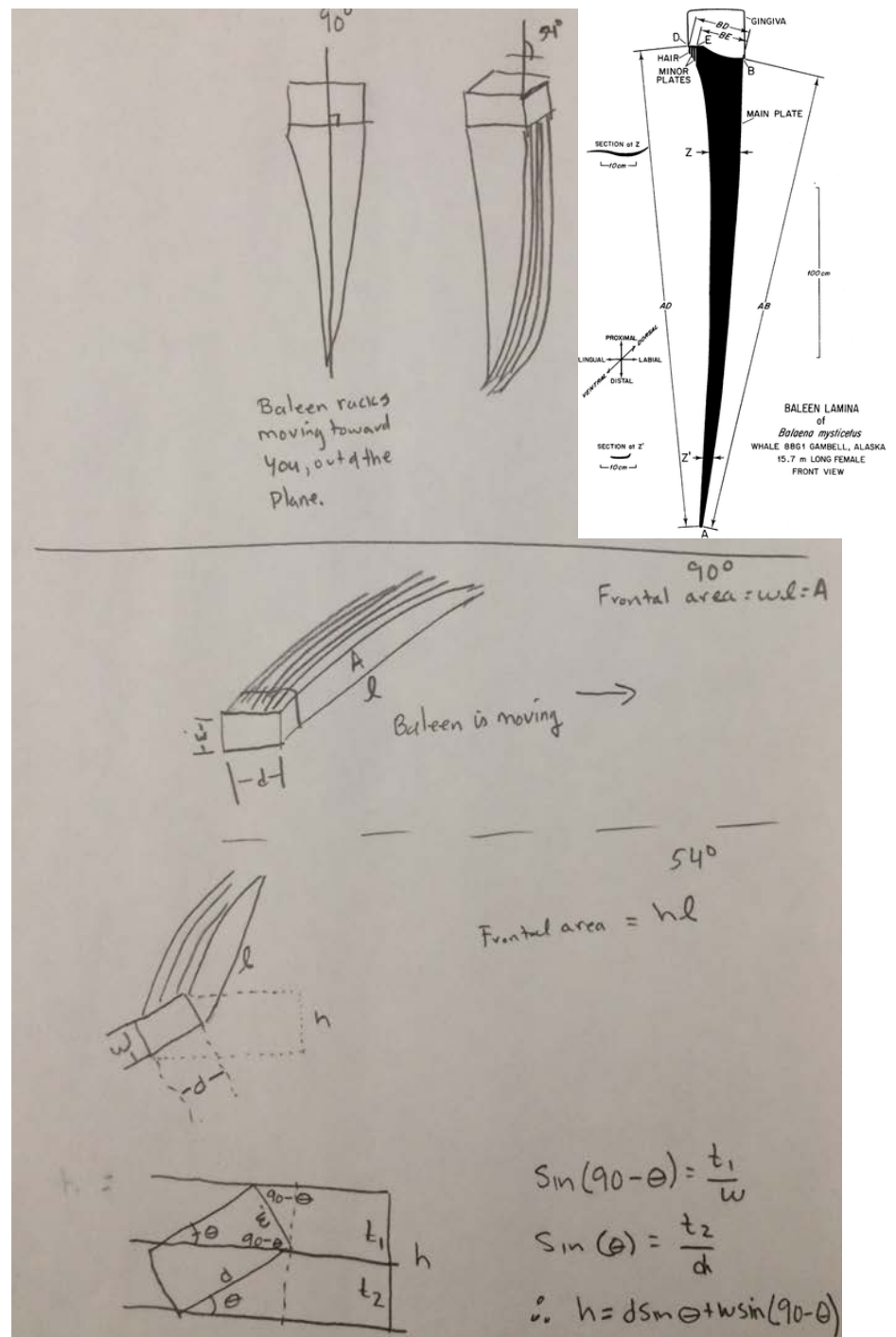

Baleen samples and calculation of frontal area
and ratio (exponentiated) between 54°/90° within a rack

Baleen Sample	Length (cm)	Depth (cm)	Width (cm)	Log Frontal Area (90°)	Log Frontal Area (54°)	Ratio of 54 to 90° by baleen rack
B30Long	200	41	26	8.556	9.17	1.86
B30short	110	29.2	12	7.185	8.12	2.55
B15	270	26	31	9.032	9.26	1.26
B10	270	15	31	9.032	9.01	0.97
B5	270	9	31	9.032	8.83	0.82
B22	190	37	19.8	8.233	8.97	2.09
B20	193	26	22.3	8.367	8.79	1.53



Run 28, recorded at 10 Hz. Data points with red lines are used to calculate median drag and mad.

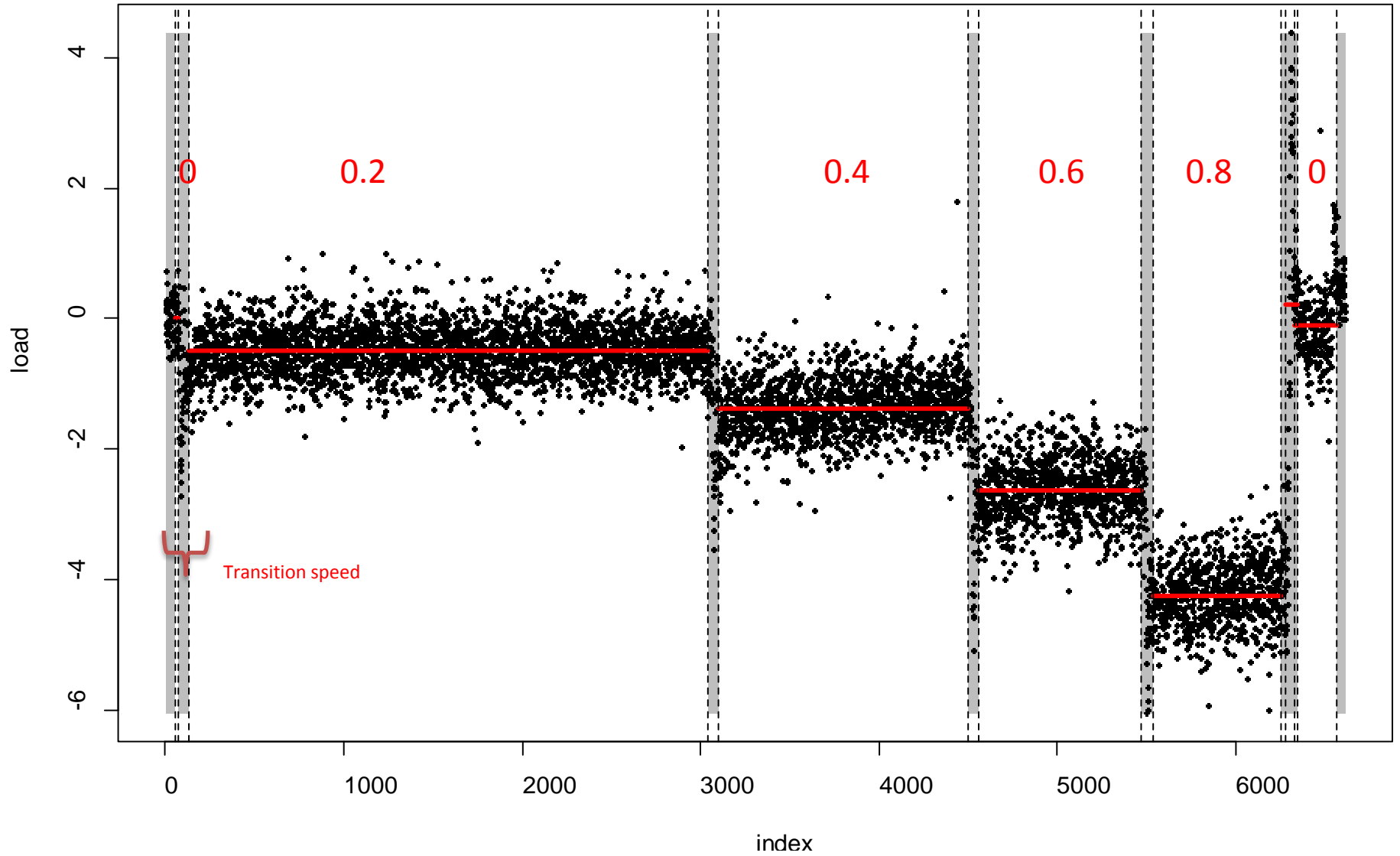

Surface oil (fresh). Boom not touching water. Run 61

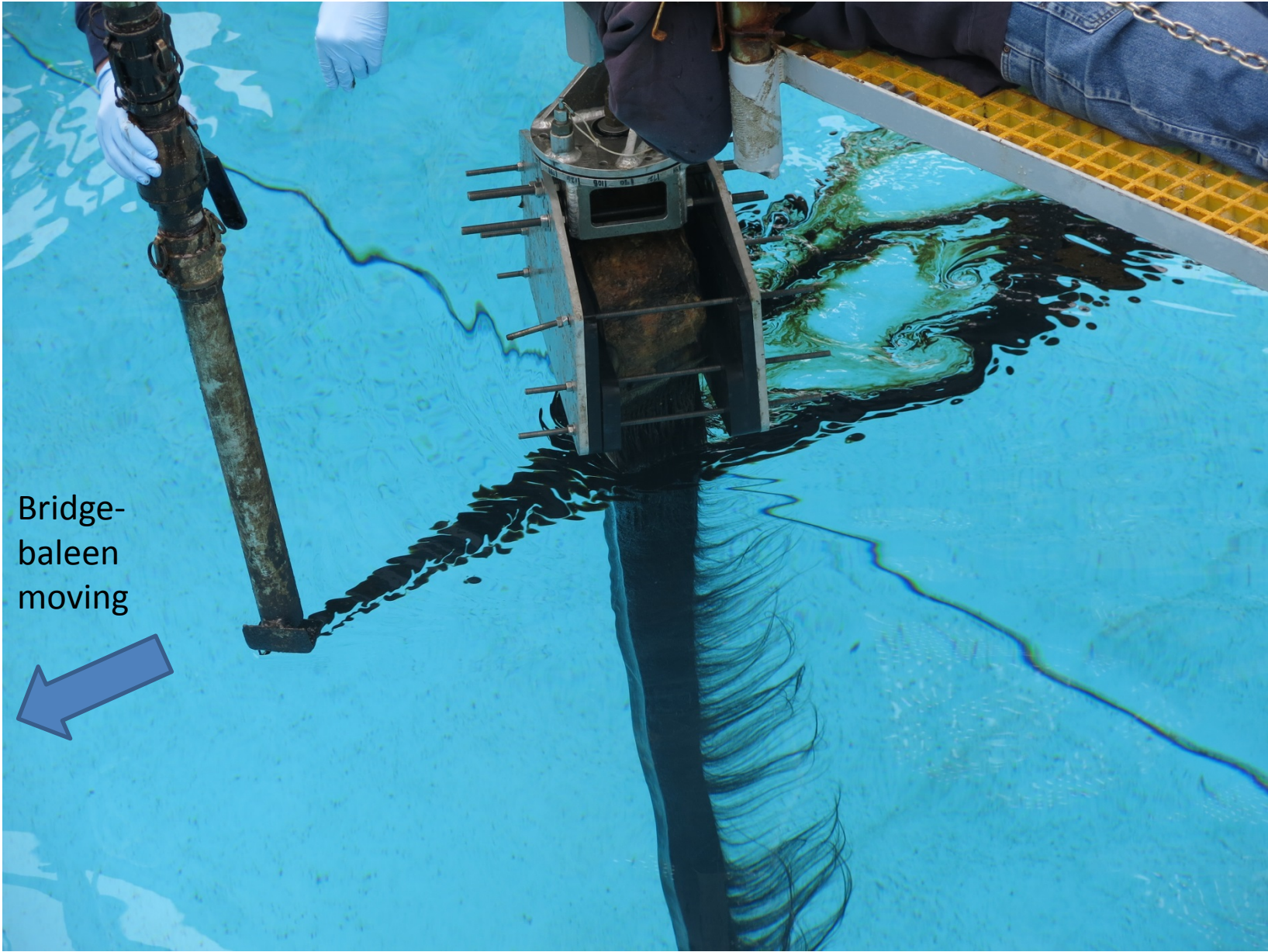

Bridge-
baleen
moving



Boom dip. Done in this order

1. Lowered baleen in water in
2. Filled white hoop with oil (p
3. Withdrew baleen
4. Conduct run



Apply dispersed
oil
Video clip



Photo of Run 69

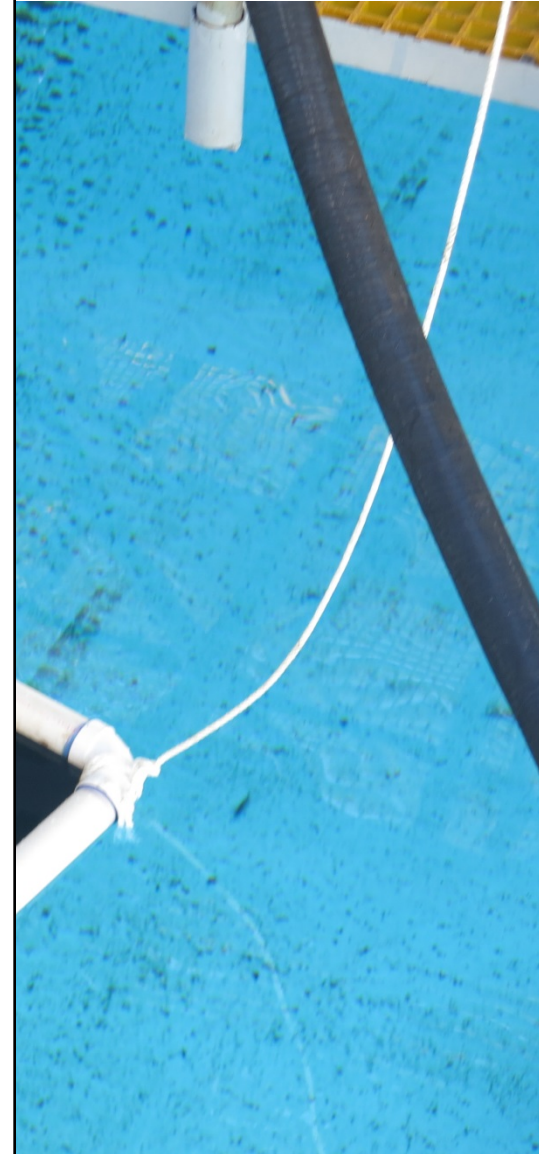

Results: (54 degrees and 0.6 knots)

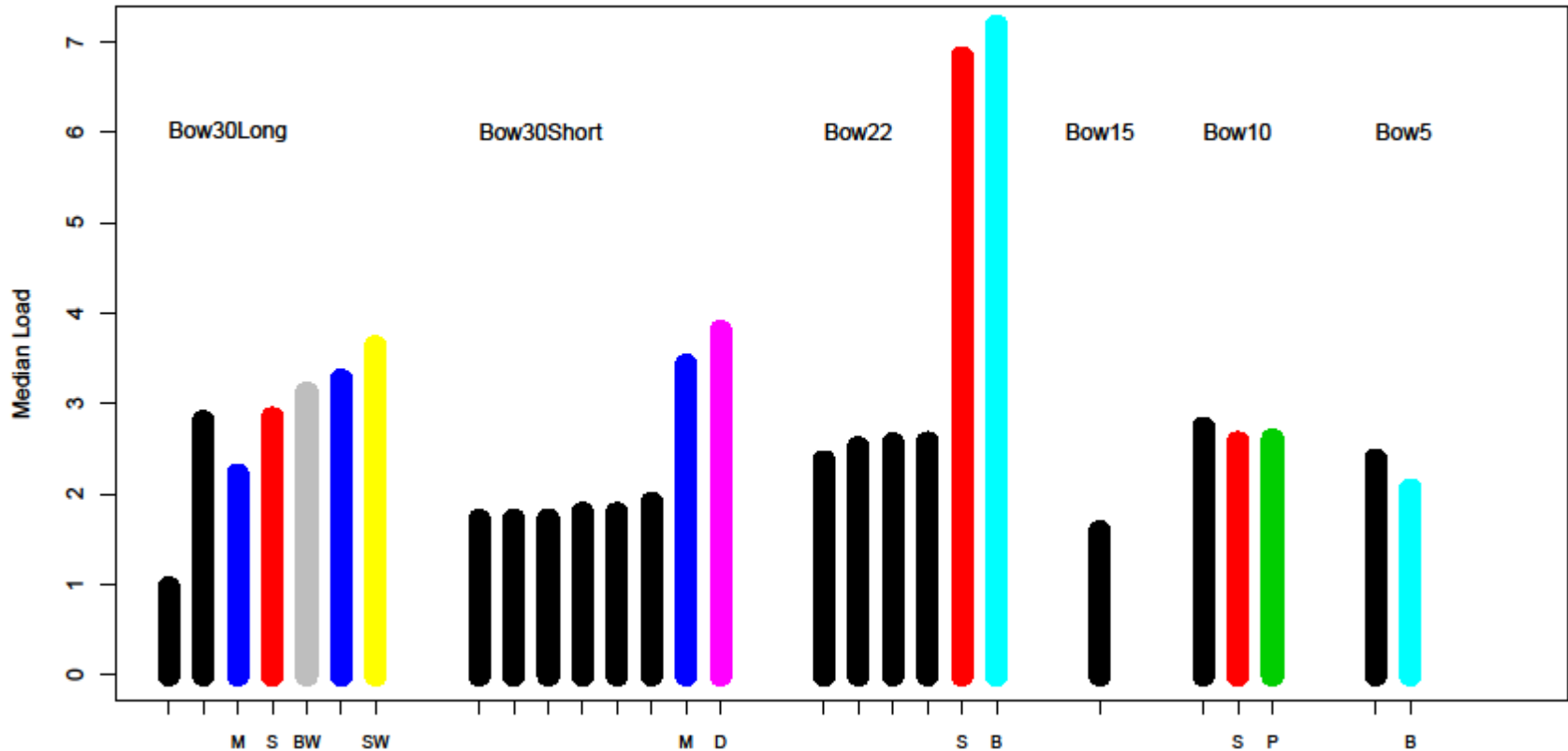

- Control runs (n=15, black), 7 trt over 5 racks.
- Treatments: **S** (surface oil); **P** (painted oil); **M** (oil and dispersant via manifold); **B** (boom dip); **D** (dispersant); **SW** (weathered, surface); and **BW** (weathered, boom dip)
- Destructive sampling:
- Results indicate that under various treatments of oil and/or oil-dispersant drag does not appear to increase

A side study: ability of oil to wet baleen

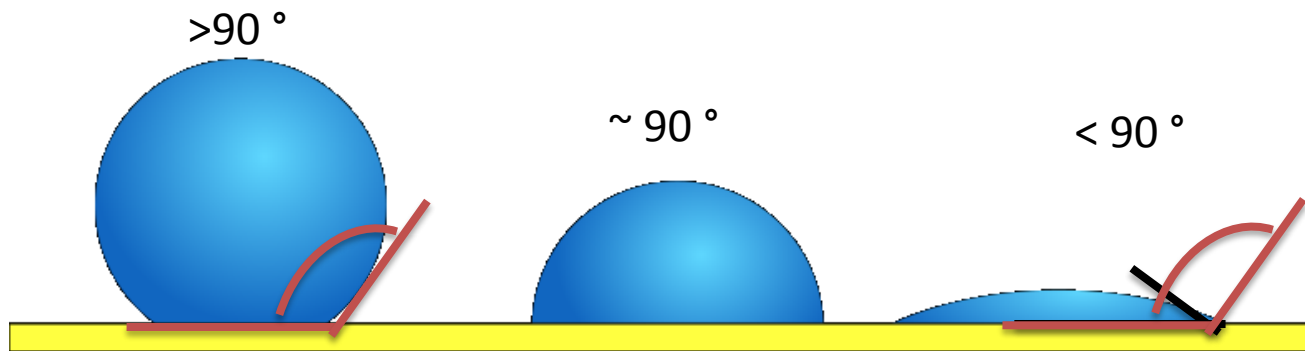

From left to right, decreasing surface tension and contact angle (source: White, Harvey E. (1948). *Modern College Physics* p 164).

Contact Angle Measurements (conducted at Future Digital Scientific)

	Mean angle	STD	N
Crude oil (fresh)	144.5	22.0	6
Crude + dispersant	54.4	17.8	6
Crude oil 5°C	144.5	22.0	6
Crude oil -1.5°C	145.5	10.0	2

Does NOT necessarily mean biological significance

Acknowledgements

- Thanks to the Barrow Whaling Captain's Association, Alaska Eskimo Whaling Commission, and NSB for supporting this project. We especially want to thank Harry Brower, Jr., Billy Adams, and Qaiyaan Harcharek for providing bowhead baleen samples
- OMSETT staff and engineers
- Funding: NOAA and North Slope Borough Department of Wildlife Management
- Work was conducted under NMFS Permits 17350 and 18786

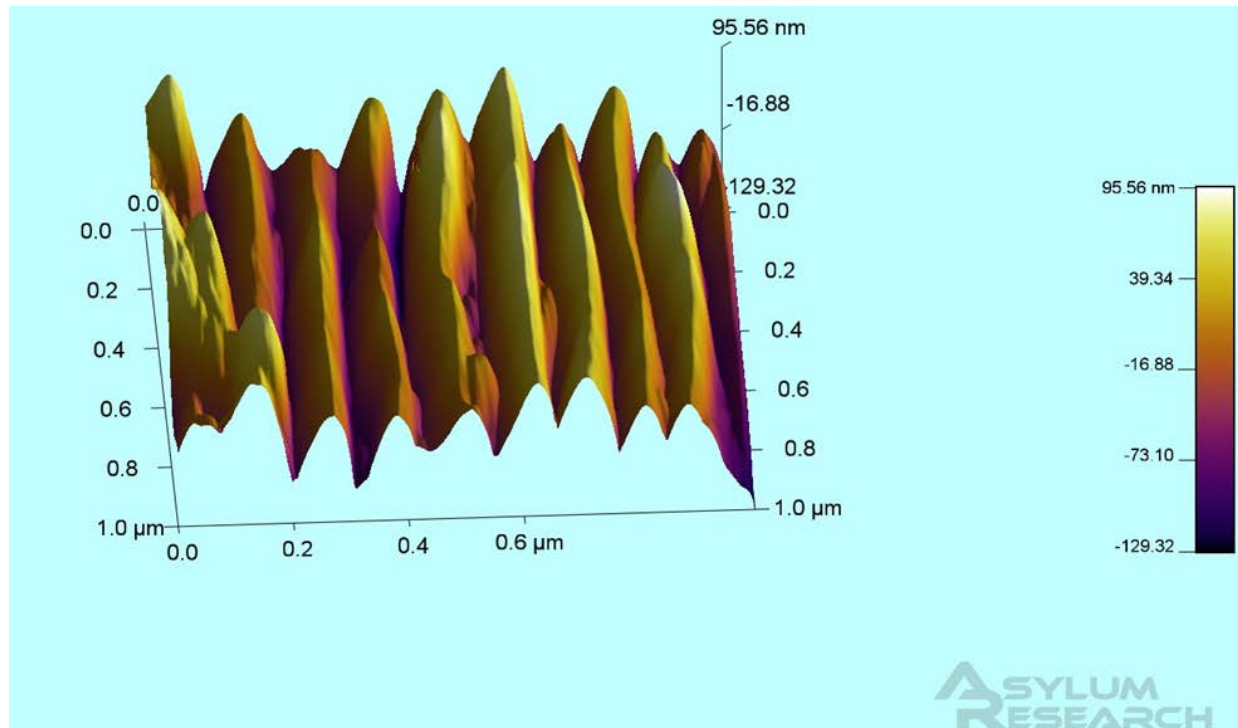

Baleen plate imaged on an atomic force microscope at Asylum Research (Santa Barbara, CA) by Todd Sformo and Sophia Hohlbauch.

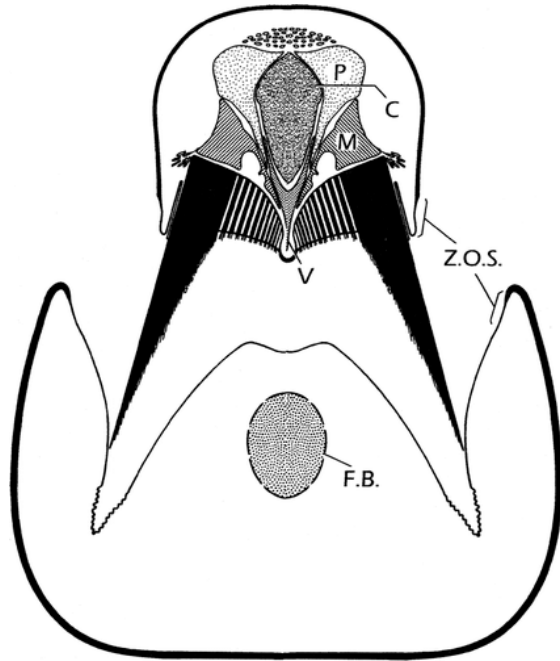

Lambertsen (2005)

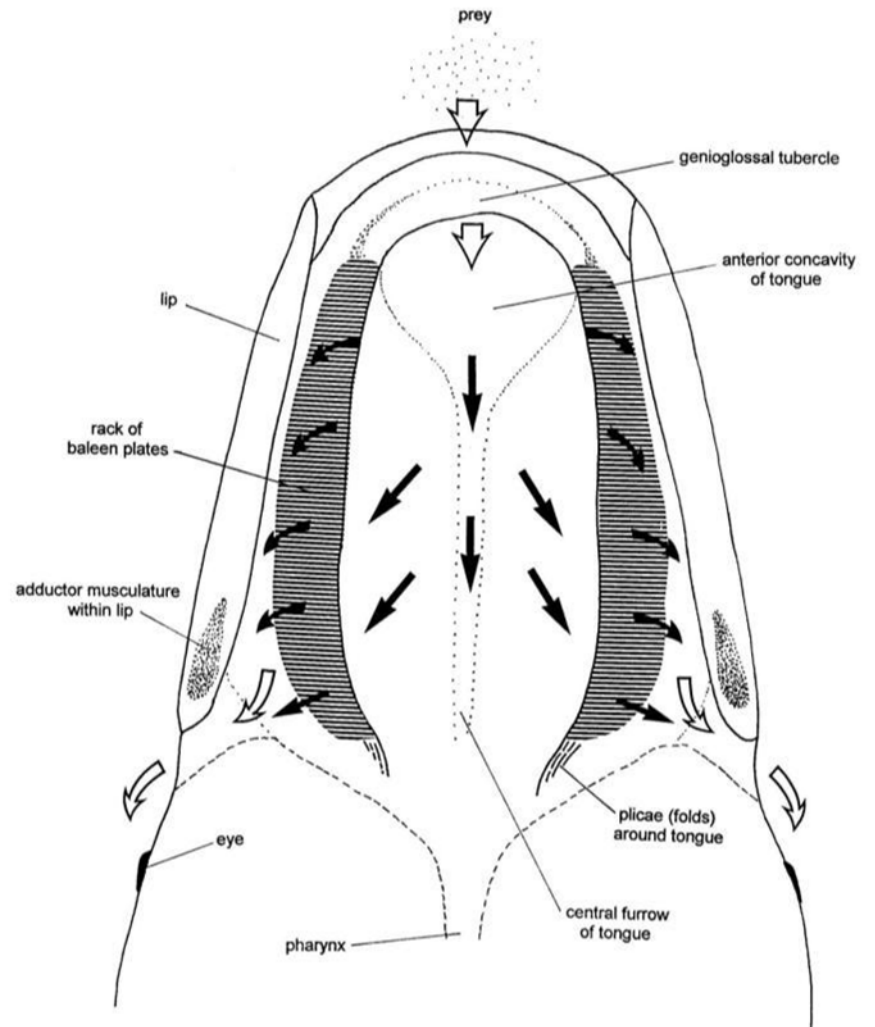
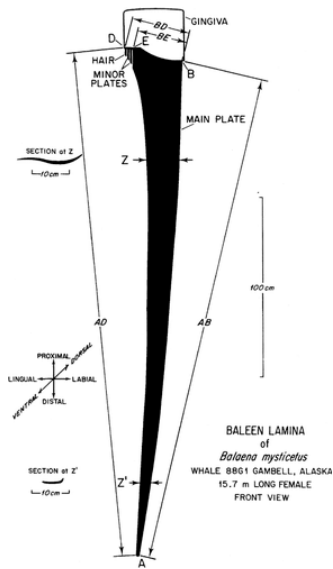

Werth 2004 (Dorsal View)



Bow 15 on left shows the cleaving of plates into 3- or 4- plate groups at higher speeds. Photo on the right indicates the decreasing plate-group cleaving after tying plates together.

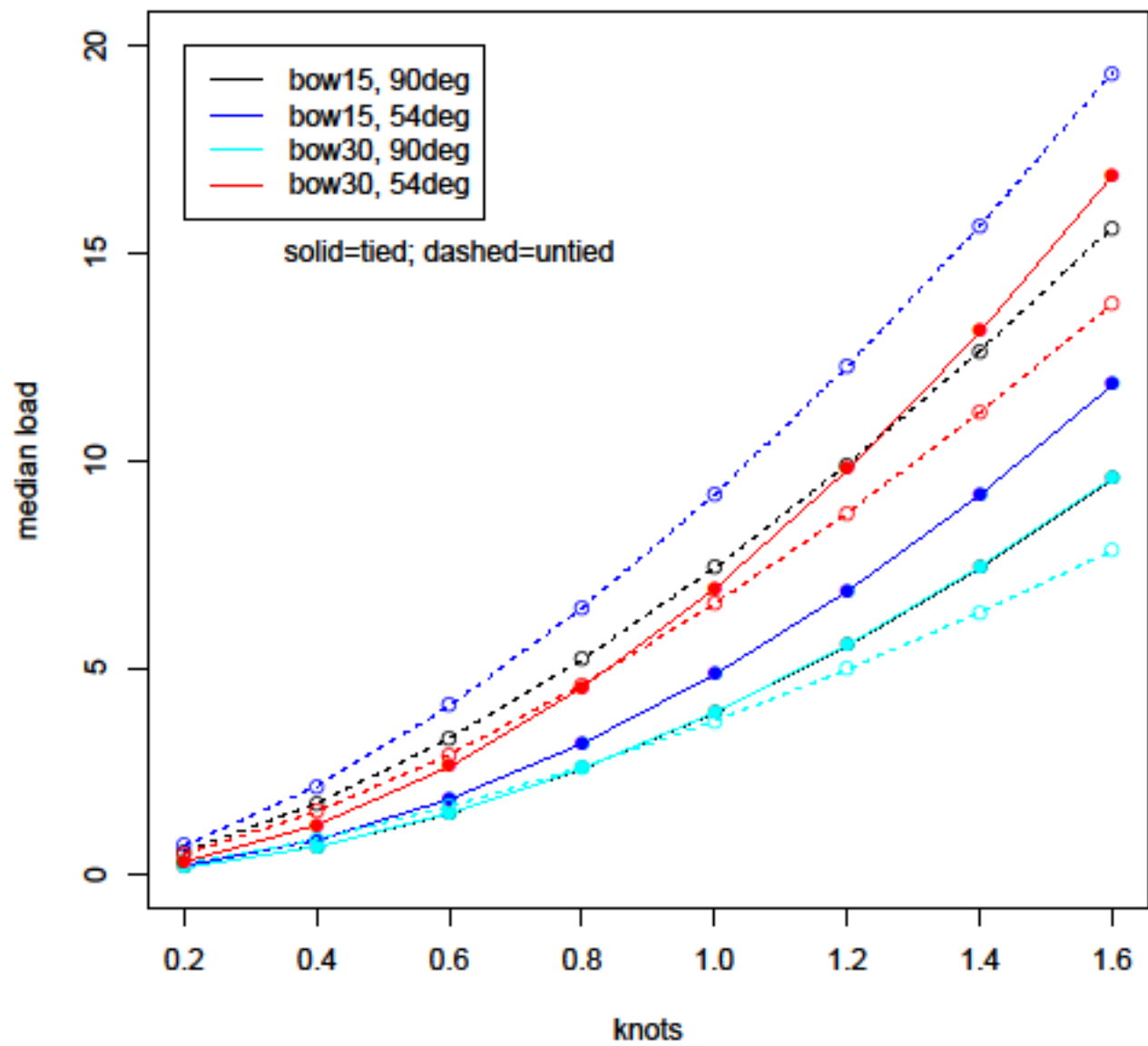

The first analysis compared tied and untied baleen. The ANOVA table is as follows:

	Estimate	Std. Error	t value	Pr(> t)	
(Intercept)	-5.75171	1.64945	-3.487	0.000693	***
log.fa.meas	0.90793	0.17005	5.339	4.76e-07	***
logknots	1.58614	0.13132	12.079	< 2e-16	***
fac.tied1	-1.84111	0.40196	-4.580	1.18e-05	***
depth.meas	-0.01719	0.01065	-1.615	0.109095	
logknots:fac.tied1	0.31060	0.15889	1.955	0.053038	.
fac.tied1:depth.meas	0.04631	0.01219	3.800	0.000233	***

We see that tied=1 (that is, tied baleen) has significantly less drag than untied, after controlling for frontal area, velocity, the “depth” of the rack, and interactions.

the boxplot represents control runs for 19 observations of 7 racks, predominately bow30short, bow22 and bow20, 54 degrees, 0.6 knots

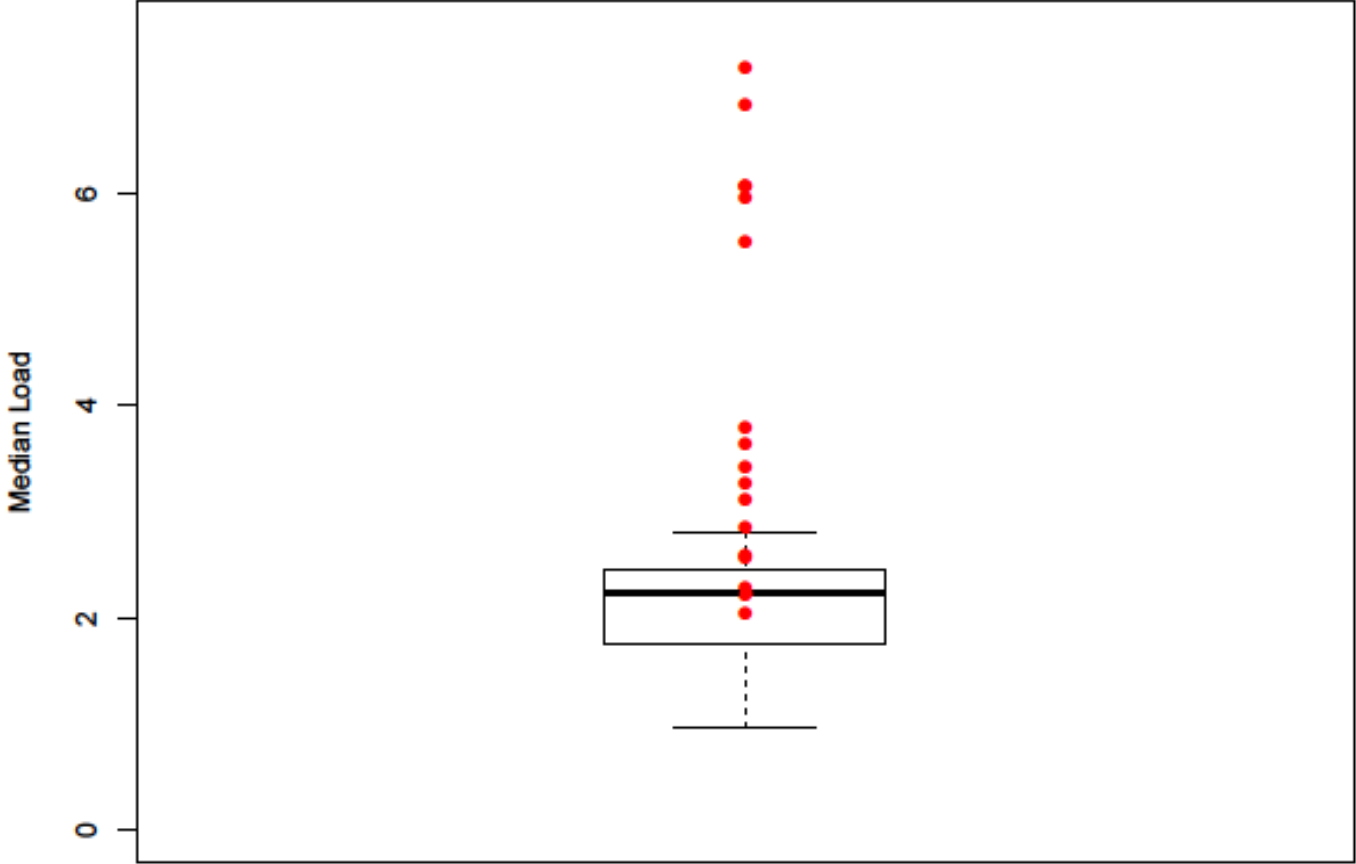

“Baleen bristles [or fringe] establish the basic functional unit of the whale’s filtration system” (Lamberstein *et al.* 1989, p. 38)

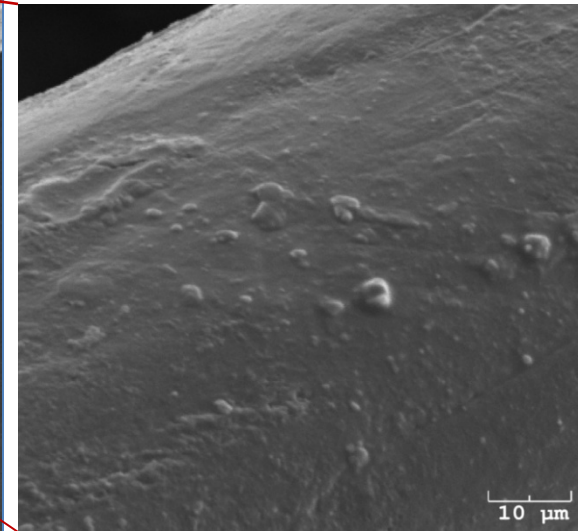
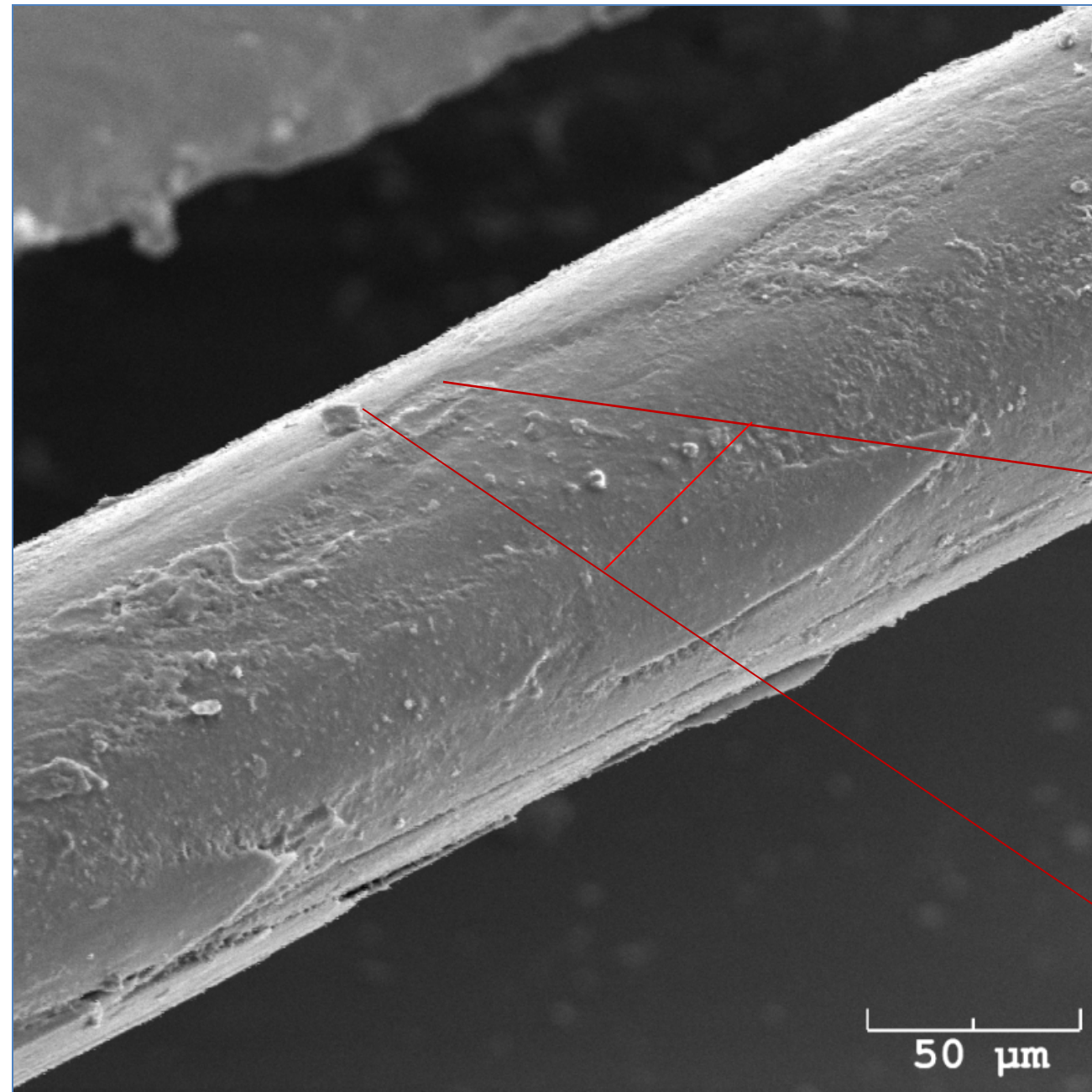

A close-up of a bowhead fringe hair



Cite this article: Werth AJ, Harriss RW, Rosario MV, George JC, Sformo TL. 2016 Hydration affects the physical and mechanical properties of baleen tissue. *R. Soc. open sci.* 3: 160591. <http://dx.doi.org/10.1098/rsos.160591>

Received: 12 August 2016
Accepted: 26 September 2016

Subject Category:
Biology (whole organism)

Subject Areas:
biomaterials/biomechanics

Keywords:
mysticete, whale, stiffness, histology, biomechanics, hydrophilic

Author for correspondence:
Alexander J. Werth
e-mail: awerth@hsc.edu

Electronic supplementary material is available online at <https://dx.doi.org/10.6084/m9.figshare.c.3517572>.

Hydration affects the physical and mechanical properties of baleen tissue

Alexander J. Werth¹, Robert W. Harriss¹, Michael V. Rosario², J. Craig George³ and Todd L. Sformo³

¹Department of Biology, Hampden-Sydney College, Hampden-Sydney, VA 23943, USA

²Department of Biology, Duke University, Durham, NC 27706, USA

³Department of Wildlife Management, North Slope Borough, Barrow, AK 99723, USA

AJW, 0000-0002-7777-478X

Baleen, an anisotropic oral filtering tissue found only in the mouth of mysticete whales and made solely of alpha-keratin, exhibits markedly differing physical and mechanical properties between dried or (as in life) hydrated states. On average baleen is 32.35% water by weight in North Atlantic right whales (*Eubalaena glacialis*) and 34.37% in bowhead whales (*Balaena mysticetus*). Baleen's wettability measured by water droplet contact angles shows that dried baleen is hydrophobic whereas hydrated baleen is highly hydrophilic. Three-point flexural bending tests of mechanical strength reveal that baleen is strong yet ductile. Dried baleen is brittle and shatters at about 20–30 N mm⁻² but hydrated baleen is less stiff; it bends with little force and absorbed water is squeezed out when force is applied. Maximum recorded stress was 4× higher in dried (mean 14.29 N mm⁻²) versus hydrated (mean 3.69 N mm⁻²) baleen, and the flexural stiffness was >10× higher in dried (mean 633 N mm⁻²) versus hydrated (mean 58 N mm⁻²) baleen. In addition to documenting hydration's powerful effects on baleen, this study indicates that baleen is far more pliant and malleable than commonly supposed, with implications for studies of baleen's structure and function as well as its susceptibility to oil or other hydrophobic pollutants.

1. Background

Baleen is a uniquely specialized oral tissue with no functional analogue or evolutionary homologue. It hangs in sheets (called plates or laminae) from the palate of whales, where it filters aggregations of small planktonic or nektonic prey from seawater. Baleen's origin approximately 30 Ma in the Oligocene Epoch was a key innovation that led to an adaptive radiation in the mammalian Suborder Mysticeti and the evolution of gigantic body size in whale species [1–3].

© 2016 The Authors. Published by the Royal Society under the terms of the Creative Commons Attribution License <http://creativecommons.org/licenses/by/4.0/>, which permits unrestricted use, provided the original author and source are credited.

Water content of bowhead baleen ~ 34.7%

Oil & dispersant via manifold (M). Run 122

Baleen
X

Baleen (x) and
Bridge moving

