

# Atlantic Shores Offshore Wind Construction and Operations Plan

Lease Area OCS-A 0499



Cover art by Sandra Daly Art & Design

## Volume I: Project Information

Submitted by:

**ATLANTIC SHORES**  
offshore wind

September 2021

Submitted to:

**BOEM**  
BUREAU OF OCEAN ENERGY MANAGEMENT

Prepared by:

**EDR**  
a better environment

**Epsilon**  
ASSOCIATES INC.

# CONSTRUCTION AND OPERATIONS PLAN

## VOLUME I – PROJECT INFORMATION

Submitted to:

**Bureau of Ocean Energy Management**

45600 Woodland Rd

Sterling, VA 20166

*Submitted by:*

**Atlantic Shores Offshore Wind, LLC**



*Prepared by:*

Environmental Design & Research,  
Landscape Architecture, Engineering & Environmental Services, D.P.C.

and

Epsilon Associates, Inc.

**September 2021**

# Executive Summary

## Introduction

Atlantic Shores Offshore Wind, LLC (Atlantic Shores) is a 50/50 joint venture between EDF-RE Offshore Development, LLC (a wholly owned subsidiary of EDF Renewables, Inc. [EDF Renewables]) and Shell New Energies US LLC (Shell). Atlantic Shores is submitting this Construction and Operations Plan (COP) to the Bureau of Ocean Energy Management (BOEM) for the development of two offshore wind energy generation projects within the southern portion of Lease Area OCS-A 0499 (the Lease Area).

The purpose of these projects is to develop offshore wind energy generation facilities within the Lease Area to provide clean, renewable energy to the Northeastern U.S. by the mid-to-late 2020s. The projects will help both the U.S. and New Jersey achieve their renewable energy goals, diversify the State's electricity supply, increase electricity reliability, and reduce greenhouse gas (GHG) emissions. The projects will also provide numerous environmental, health, community, and economic benefits, such as the creation of substantial new employment opportunities, including within disadvantaged communities.

In accordance with the New Jersey Offshore Wind Economic Development Act (OWEDA), on June 30, 2021, the New Jersey Board of Public Utilities (NJ BPU) awarded Atlantic Shores an Offshore Renewable Energy Credit (OREC) allowance to deliver 1,510 megawatts (MW)<sup>1</sup> of offshore renewable energy into the State of New Jersey. The project that will be developed under this OREC award, referred to as Project 1, will be owned and operated by Atlantic Shores Offshore Wind Project 1, LLC (Atlantic Shores Project 1 Company). Pursuant to New Jersey Executive Orders #8 and #92, the State will be awarding additional OREC allowances to offshore wind energy projects through a competitive solicitation process every 2 years through 2026. The next competitive solicitation by New Jersey will be initiated in Q3 2022. Atlantic Shores' second project, Project 2, to be owned and operated by Atlantic Shores Offshore Wind Project 2, LLC (Atlantic Shores Project 2 Company), is being developed to support these future New Jersey solicitations. Project 1 and Project 2 are collectively referred to as "the Projects."

Atlantic Shores Offshore Wind, LLC is the owner and an affiliate of Atlantic Shores Project 1 Company and Atlantic Shores Project 2 Company. Accordingly, for ease of reference, the term "Atlantic Shores" is used throughout the COP to refer interchangeably to the Project Companies.

At the time of this COP submission, in accordance with 30 CFR 585.106, 585.107, and 585.409, Atlantic Shores has requested the assignment of the Project 1 and Project 2 development areas within the Lease Area to Atlantic Shores Project 1 Company and Project 2 Company jointly.

---

<sup>1</sup> The New Jersey Board of Public Utilities awarded a contract to Atlantic Shores for 1,509.6 MW, which solely for convenience is rounded up to 1,510 MW throughout the COP.

## Overview of the Projects

Atlantic Shores' Lease Area is located on the OCS within the New Jersey Wind Energy Area (NJWEA), which was identified by BOEM as suitable for offshore renewable energy development through a multi-year, public environmental review process. The Projects will be located in an approximately 102,124-acre (413.3-square kilometer [km<sup>2</sup>]) Wind Turbine Area (WTA) located in the southern portion of the Lease Area (see Figure E-1). Project 1 is located in the western 54,175 acres (219.2 km<sup>2</sup>) of the WTA, and Project 2 is located in the eastern 31,847 acres (128.9 km<sup>2</sup>) of the WTA, with a 16,102-acre (65.2-km<sup>2</sup>) Overlap Area that could be used by either Project 1 or Project 2. Figure E-1 also depicts the boundaries of the Project 1 and Project 2 areas within the WTA.

At its closest point, the WTA is approximately 8.7 miles (mi) (14 kilometers [km]) from the New Jersey shoreline. The WTA will include an array of wind turbine generators (WTGs) and multiple offshore substations (OSSs). A meteorological (met) tower and/or meteorological and oceanographic (metocean) buoys may also be installed in the WTA. The WTA layout is designed to maximize offshore renewable wind energy production while minimizing effects on existing marine uses. The structures will be aligned in a uniform grid with multiple lines of orientation allowing straight transit through the WTA.

Within the WTA, the WTGs and OSSs for Project 1 and Project 2 will be connected by two separate, electrically distinct systems of inter-array cables and/or inter-link cables. Energy from the OSSs will be delivered to shore by export cables that will travel within designed Export Cable Corridors (ECCs) from the WTA through federal and New Jersey state waters to one or two landfall sites on the New Jersey coastline. The Atlantic ECC extends from the western tip of the WTA to the Atlantic Landfall Site in Atlantic City, New Jersey. The Monmouth ECC extends from the eastern corner of the WTA, along the eastern edge of the Lease Area, to the Monmouth Landfall Site in Sea Girt, New Jersey. Both Projects 1 and 2 have the potential to use either ECC and offshore export cables for each may also be co-located within an ECC.

At both the Monmouth and Atlantic Landfall Sites, horizontal directional drilling (HDD) will be employed to minimize impacts to the intertidal and nearshore habitats and ensure stable burial of the cables. From each landfall site, the onshore interconnection cables will travel underground primarily along existing roadways, utility rights-of-way (ROWs), and/or along bike paths to two new onshore substation sites. From the onshore substations, the onshore interconnection cables will continue to existing substations where the Projects will be interconnected into the electrical grid at the Cardiff Substation point of interconnection (POI) in Egg Harbor Township, New Jersey and/or the Larrabee Substation POI in Howell, New Jersey. While both Project 1 and Project 2 will be electrically distinct from one another, the Projects require the ability to interconnect at the two POIs to accommodate the maximum amount of electricity that could be generated by the Projects.

8/20/2021 | G:\Projects\21\56512021\Task\_1\Map\Fig E-1 Project Overview\_w\_20210819.mxd

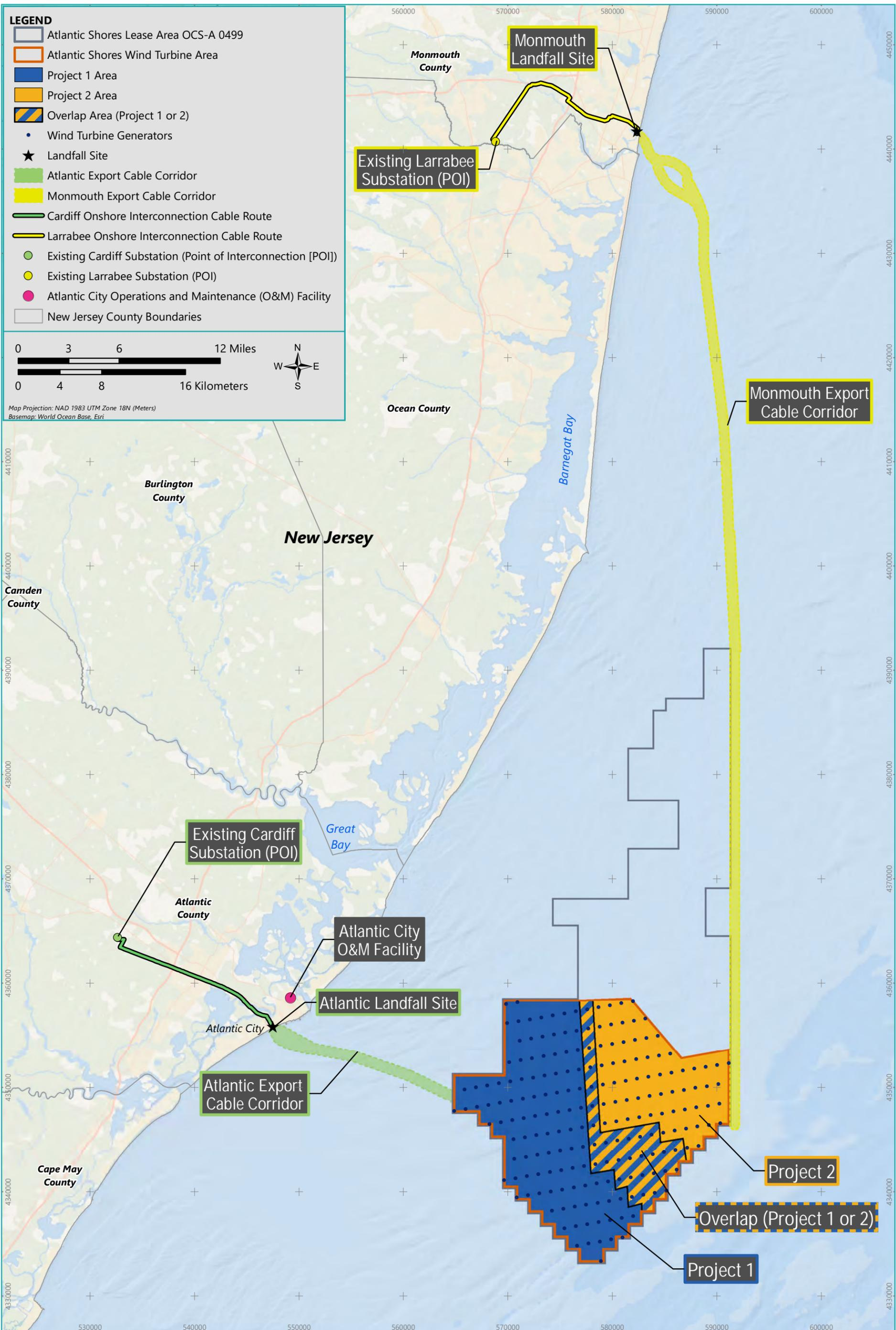

- LEGEND**
- Atlantic Shores Lease Area OCS-A 0499
  - Atlantic Shores Wind Turbine Area
  - Project 1 Area
  - Project 2 Area
  - Overlap Area (Project 1 or 2)
  - Wind Turbine Generators
  - ★ Landfall Site
  - Atlantic Export Cable Corridor
  - Monmouth Export Cable Corridor
  - Cardiff Onshore Interconnection Cable Route
  - Larrabee Onshore Interconnection Cable Route
  - Existing Cardiff Substation (Point of Interconnection [POI])
  - Existing Larrabee Substation (POI)
  - Atlantic City Operations and Maintenance (O&M) Facility
  - New Jersey County Boundaries

0 3 6 12 Miles

0 4 8 16 Kilometers

N  
W E  
S

Map Projection: NAD 1983 UTM Zone 18N (Meters)  
Basemap: World Ocean Base, Esri

## Organization of the COP

This COP has been developed in accordance with 30 CFR Part 585, applicable BOEM and other regulatory guidance, and the stipulations in Atlantic Shores' Lease Agreement OCS-A 0499. This COP is organized into two volumes:

- Volume I provides detailed descriptions of the Projects' offshore and onshore facilities and how Atlantic Shores plans to construct, operate, and decommission those facilities.
- Volume II provides a comprehensive assessment of the Projects' potential effects to physical, biological, visual, cultural, and socioeconomic resources and describes the numerous measures that Atlantic Shores will employ to avoid, minimize, and mitigate those potential effects. Volume II also characterizes the Projects' environmental setting.

While this COP only describes the development of the southern portion of the Lease Area, as assigned to (or pending assignment to) Atlantic Shores Project 1 Company and Atlantic Shores Project 2 Company, Atlantic Shores maintains the right to develop the remainder of the Lease Area, which would be permitted under separate filings.

## Project Design Envelope

Atlantic Shores is requesting BOEM's review and authorization of the Projects in accordance with BOEM's (2018) Project Design Envelope (PDE) guidance. The PDE identifies a reasonable range of designs for the proposed Project components and installation techniques. Key elements of the Projects' PDE are included in Table E-1.

Atlantic Shores has sited the Projects' facilities and developed the PDE to maximize renewable energy production, minimize environmental effects, minimize cost to ratepayers, and address stakeholder concerns. The PDE articulates the maximum design scenario for key project components, such as the type and number of WTGs, foundation types, OSS types, cable types, and installation techniques. The PDE provides Atlantic Shores with the necessary flexibility to respond to anticipated advancements in industry technologies and techniques, that even under a maximum scenario will not exceed an unreasonable level of environmental effects.

Table E-1 Key Elements of the PDE

Element	Project Design Element	Total	Project 1	Project 2
WTGs	<b>Max. Number of WTGs</b>	200 (inclusive of the 31 WTGs in the Overlap Area) <sup>a</sup>	105-136	64-95
	<b>WTG Layout</b>	Grid layout with ENE/WSW rows and approximately N/S columns, consistent with the predominant flow of traffic		
	<b>Max. rotor diameter</b>	918.6 ft (280.0 m)		
	<b>Max. tip height<sup>b</sup></b>	1,048.8 ft (319.7 m)		
OSSs	<b>Max. Number of OSSs</b>	10 small OSSs, or	5	5
		5 medium OSSs, or	2	3
		4 large OSSs	2	2
	<b>OSS Layout</b>	Positioned along the same ENE/WSW rows as WTGs		
	<b>Min. Distance from Shore</b>	Small OSS: 12 mi (19.3 km)		
Medium and large OSS: 13.5 mi (21.7 km)				
WTG and OSS Foundations	<b>Foundation types</b>			
	<b>Piled</b>	Monopiles or piled jackets		
	<b>Suction bucket</b>	Mono-buckets, suction bucket jackets, or suction bucket tetrahedron bases <sup>c</sup>		
	<b>Gravity</b>	Gravity-base structures (GBS) or gravity-pad tetrahedron bases <sup>c</sup>		
	<b>Max. pile diameter at seabed (for piled foundation types)</b>	Monopile: 49.2 ft (15.0 m)		
Piled jacket: 16.4 ft (5.0 m)				
Inter-Array and Inter-Link Cables	<b>Cable types and voltage</b>	Inter-array: 66–150 kV high voltage alternating current (HVAC)		
		Inter-link: 66–275 kV HVAC		
	<b>Max. Total Cable Length</b>	Inter-array: 547 mi (880 km)	273.5 mi (440 km)	273.5 mi (440 km)
		Inter-link: 37 mi (60 km)	18.6 mi (30 km)	18.6 mi (30 km)
<b>Target burial depth range</b>	5 to 6.6 ft (1.5 to 2 m)			

Table E-1 Key Elements of the PDE (Continued)

Element	Project Design Element	Total	Project 1	Project 2
Export Cables	Cable types and voltage	230–275 kV HVAC cables or 320–525 kV high voltage direct current (HVDC) cables		
	Number of ECCs	Two: Atlantic ECC and Monmouth ECC		
	Max. Number of Cables	8 total: HVAC or HVDC export cables		
	Max. Total Cable Length	Atlantic Landfall Site to OSSs: 99.4 mi (160.0 km) Monmouth Landfall Site to OSSs: 341.8 mi (550.0 km)		
	Target burial depth range	5 to 6.6 ft (1.5 to 2 m)		
Met Towers	Max. Number of Met Towers	Total: 1 (permanent)	1	0
Metocean Buoys	Max Number of Metocean Buoys	Total: 4 (Temporary, during construction)	3	1
Landfall Sites	Number of Landfall Sites	Atlantic Landfall Site		
		Monmouth Landfall Site		
	Installation Method	HDD		
Onshore Facilities	Number of Onshore Interconnection Cable Routes	Cardiff Onshore Interconnection Cable Route		
		Larrabee Onshore Interconnection Cable Route		
	Approx. route length	12 mi (19 km) each		
	Onshore interconnection cable types and voltage	230–275 kV HVAC cables installed in underground duct bank; or 320–525 kV HVDC cables installed in underground duct bank		
	Number of Onshore Substations	Total: two (one per POI), each with a preferred and an alternate site		
Points of Interconnection (POI)	Cardiff POI			
	Larrabee POI			
O&M Facility	Location	New operations and maintenance (O&M) facility proposed in Atlantic City, New Jersey		

Notes: a) The number of WTGs in Project 1, Project 2, and the associated Overlap Area will not exceed 200 WTG locations. For example, if Project 1 includes 105 WTGs (the minimum) then the Overlap Area would be incorporated into Project 2 which would include the remaining 95 WTGs; and conversely if the Overlap Area is incorporated into Project 1 such that it includes 136 WTGs, then Project 2 would be limited to 64 WTGs. Each Project may also use only part of the Overlap Area.  
 b) All elevations are provided relative to Mean Lower Low Water (MLLW).  
 c) Tetrahedron base foundations are included in the PDE for WTGs but not OSSs.

Gray highlighting represents no differentiation between the Project Design Elements of Project 1 and Project 2



## Construction

To maximize construction synergy and efficiency, the construction schedules for Project 1 and Project 2 assumes the same installation teams and equipment (e.g., vessels) will be used to support the construction of both Projects. This strategy will limit demobilization and remobilization of equipment and crews which will help to reduce construction costs, increase schedule efficiency, and minimize environmental effects (e.g., emissions, vessel transits). This procedure will also provide continuous fabrication in manufacturing facilities to maintain employment and increase productivity. It will also reduce delays in the Federal permitting schedule tied to a Project's Final Investment Decision (FID) and allow Atlantic Shores to secure production slots. This strategy would also result in significant benefits to ratepayers, which is a critical component of state OREC solicitations.

Construction of each Project will begin with the onshore facilities, including the onshore substations and onshore interconnection cables. The onshore interconnection cables will be installed within a buried concrete duct bank. Techniques such as HDD, pipe jacking, or jack-and-bore are anticipated at unique features such as busy roadways, wetlands, and waterbodies to minimize impacts.

Construction of the offshore facilities is expected to begin with installation of the export cables and the foundations. Once the OSS foundations are installed, the OSS topsides and the inter-link cables (if used) can be installed. At each WTG position, after the foundation is installed, the associated inter-array cables and WTG can be installed. Scour protection may be installed at the base of the foundations and cable protection may be installed over a portion of the offshore cables. During commissioning, the WTG and OSS electrical and safety systems will be tested and the OSSs and WTGs will be energized.

Offshore construction may require many different types of vessels, including heavy transport vessels, heavy lift vessels, tugboats and barges, jack-up vessels, cable laying vessels, crew transfer vessels, and service operation vessels. Atlantic Shores may also use helicopters for crew transfer and visual equipment inspections as well as fixed-wing aircraft to support environmental monitoring and mitigation. Atlantic Shores has identified several port facilities in New Jersey, New York, the Mid-Atlantic, and New England that may be used for major construction staging activities for the Projects. In addition, some components, materials, and vessels could come from U.S. Gulf Coast or international ports. Activities at the ports may include component fabrication and assembly, offloading and loading shipments of project components, preparing vessels to tow floating components to the WTA, crew transfer, refueling, and restocking supplies.

## Operations and Maintenance

Once installed and commissioned, both Project 1 and Project 2 are designed to operate for up to 30 years.<sup>2</sup> Operations and maintenance (O&M) activities will ensure that the Projects function safely and efficiently. To minimize equipment downtime and maximize energy generation, the Projects will conduct O&M activities through scheduled, predictive, and remotely-controlled activities.

The Projects' facilities are designed to operate autonomously without attendance by technicians. The Projects will be equipped with a supervisory control and data acquisition (SCADA) system, which provides an interface between each Project's facilities and all environmental and condition monitoring sensors and provides detailed performance and system information. The operator will monitor the status, production, and health of the Projects, 24 hours a day. The Projects will be supported by a new O&M facility that Atlantic Shores is proposing to establish in Atlantic City, New Jersey.

## Decommissioning

At the end of their operational life, the Projects will be decommissioned. Decommissioning will broadly occur in the reverse order of construction and will be conducted in accordance with the requirements of Atlantic Shores' Lease Agreement, 30 CFR Part 585, and the Decommissioning Application that Atlantic Shores will submit to BOEM prior to decommissioning.

## Health, Safety, Security, and Environmental Protection

Health, safety, security, and environmental (HSSE) protection are critical components of all Atlantic Shores' planning and activities. The health and safety of Atlantic Shores' team members, contractors, and the public is a key priority; Atlantic Shores upholds safety as a core value and fosters a culture of "Goal Zero" that focuses on eliminating safety related incidents. Atlantic Shores also prioritizes the responsible integration of the Projects into the New Jersey coastal and marine environment.

Atlantic Shores is committed to full compliance with applicable HSSE regulations and codes throughout the pre-construction, construction, O&M, and decommissioning phases of the Projects. Plans that will be implemented, in accordance with BOEM and other applicable regulations, to ensure HSSE protection throughout the Projects' lifecycles will include project-specific Safety Management Systems (SMS), Oil Spill Response Plans (OSRP), and Spill Prevention, Control, and Countermeasure (SPCC) Plans for the Projects.

---

<sup>2</sup> Atlantic Shores' Lease Agreement OCS-A 0499 includes a 25-year operating term, which may be extended or otherwise modified in accordance with applicable regulations in 30 CFR Part 585.

## Stakeholder Engagement

Atlantic Shores is actively engaged with stakeholders to identify and discuss their interests and concerns regarding the development of the Projects. Since early 2019, Atlantic Shores has conducted hundreds of meetings and working sessions with stakeholders, suppliers, interest groups, and local communities that have an interest in or may be affected by the Projects. Atlantic Shores will continue to host and participate in meetings, community events, informational sessions, open houses, and workshops as well as disseminate information through the Projects' interactive website and social media platforms. As the Projects progress, Atlantic Shores will continue to evolve its stakeholder engagement strategy and its mechanisms for capturing, documenting, and responding to stakeholder feedback to ensure that the outcomes of each interaction are incorporated into the Projects development efforts.

## Benefits, Effects, and Environmental Protection Measures

The Projects will provide clean, renewable energy to the Northeastern U.S. By displacing electricity from fossil fuel power plants, the Projects will result in a significant net decrease in harmful air pollutant emissions region-wide. For every megawatt of power generated by the Projects, the Projects are expected to reduce GHG emissions, reported as carbon dioxide equivalents (CO<sub>2</sub>e), by approximately 2,625 tons per year. By reducing regional GHG emissions, the Projects can help mitigate additional effects of climate change (e.g., sea level rise, shifts in species' distributions, and increases in energy system costs) that impact both public health and the environment. The Projects will also reduce regional emissions that are linked to increased rates of early death, stroke, heart attacks, and respiratory disorders and contribute to acid rain, ocean acidification, and ground level ozone/smog.

Beyond its environmental and public health benefits, the Projects will provide significant economic and community benefits to the Mid-Atlantic, including the creation of substantial new employment opportunities. The Projects are expected to directly create more than 22,290 full time equivalent (FTE)<sup>3</sup> jobs, indirectly create more than 11,810 FTE jobs, and induce over 14,820 FTE jobs throughout their lifecycles. Atlantic Shores will use local supply chains, increase revenues collected by federal, state, and local governments, and contribute to the establishment of facilities and development of ports that will be instrumental in attracting and supplying future U.S. offshore wind developments to New Jersey.

Atlantic Shores is working to maximize the benefits and minimize the effects of the Projects. Volume II of this COP describes the Projects' environmental setting, assesses the Projects' potential effects to physical, biological, visual, cultural, and socioeconomic resources, and identifies environmental protection measures (EPMs) that could avoid or reduce those potential effects. Environmental resource assessments contained within Volume II combine years of site-specific onshore and offshore surveys, research, and modeling. The Projects' EPMs include studies, assessments, design elements, best management practices (BMPs), and potential mitigation

---

<sup>3</sup> Based on a 40-hour work week.

measures. These EPMs will evolve through ongoing consultations with appropriate agencies and stakeholders. Taking into account the Projects' EPMs, the recurring and accumulating benefits created by the Projects over their operational lives represent significant cumulative increases in environmental, economic, and social well-being compared to the primarily localized and temporary effects that will be avoided, minimized, and/or mitigated. Overall, Atlantic Shores expects that the Projects' anticipated benefits will significantly outweigh their potential effects.

# TABLE OF CONTENTS

---

<b>EXECUTIVE SUMMARY</b>	<b>E-1</b>
Introduction	E-1
Overview of the Projects	E-2
Organization of the COP	E-4
Project Design Envelope	E-4
Construction	E-7
Operations and Maintenance	E-8
Decommissioning	E-8
Health, Safety, Security, and Environmental Protection	E-8
Stakeholder Engagement	E-9
Benefits, Effects, and Environmental Protection Measures	E-9
<b>1.0 INTRODUCTION</b>	<b>1-1</b>
1.1 Overview of the Projects	1-3
1.2 Applicant’s Purpose and Need	1-7
1.3 Leasing History and Regulatory Framework	1-10
1.3.1 BOEM’s New Jersey Offshore Wind Leasing Program	1-12
1.3.2 Permits, Approvals, and Consultations	1-13
1.3.3 Commercial Lease Stipulations and Compliance	1-25
1.3.4 Guide to Location of Required Information for a COP	1-28
1.4 Agency and Stakeholder Outreach	1-36
1.4.1 Coordination with Agencies, Tribes, and Municipalities	1-36
1.4.2 Stakeholder Outreach	1-37
1.4.2.1 Fisheries Engagement	1-39
1.5 Other Project Information	1-40
1.5.1 Authorized Representative and Operator	1-40
1.5.2 Certified Verification Agent	1-40
1.5.3 Health, Safety, Security, and Environmental Protection	1-41
1.5.3.1 Safety Management System	1-41
1.5.3.2 Spill Response Plans	1-42
<b>2.0 BENEFITS OF THE PROJECTS</b>	<b>2-1</b>
2.1 Economic and Community Benefits	2-1
2.2 Environmental and Public Health Benefits	2-4
<b>3.0 EVOLUTION OF THE PROJECT DESIGN ENVELOPE</b>	<b>3-1</b>
3.1 Development of the WTA Layout	3-2
3.2 Onshore Facility Siting	3-6
3.2.1 Points of Interconnection	3-6
3.2.2 Landfall Sites	3-8

## TABLE OF CONTENTS (CONTINUED)

---

3.2.3	Onshore Interconnection Routes	3-9
3.2.4	Preferred Onshore Interconnection	3-11
3.3	Export Cable Routing	3-11
3.4	Foundation Type Selection	3-16
3.5	WTG Dimension Selection	3-17
<b>4.0</b>	<b>PROJECT DESIGN AND CONSTRUCTION ACTIVITIES</b>	<b>4-1</b>
4.1	Infrastructure Overview and Schedule	4-1
4.1.1	Project Design Envelope Overview	4-1
4.1.2	Project Construction Process and Schedules	4-3
4.2	Wind Turbine Generator Foundations	4-5
4.2.1	Piled Foundations	4-5
4.2.2	Suction Bucket Foundations	4-10
4.2.3	Gravity Foundations	4-13
4.2.4	Seabed Preparation	4-18
4.2.5	Scour Protection	4-19
4.2.6	Project Design Envelope for the WTG Foundations	4-20
4.3	Wind Turbine Generators	4-23
4.3.1	WTG Design	4-23
4.3.2	WTG Installation	4-25
4.3.3	WTG Commissioning	4-27
4.4	Offshore Substations	4-29
4.4.1	OSS Foundation Design and Installation	4-29
4.4.2	Topside Design, Installation, and Commissioning	4-34
4.4.3	Seabed Preparation and Scour Protection	4-36
4.5	Offshore Cables	4-38
4.5.1	Offshore Cable Design	4-38
4.5.1.1	Export Cables	4-38
4.5.1.2	Inter-Array and Inter-Link Cables	4-39
4.5.2	Offshore Cable Routes	4-41
4.5.2.1	Export Cable Corridors	4-41
4.5.2.2	Inter-Array and Inter-Link Cable Routes	4-45
4.5.3	Pre-Installation Activities	4-45
4.5.3.1	Boulder Relocation	4-45
4.5.3.2	Sand Bedform Removal	4-45
4.5.3.3	Pre-lay Grapple Run	4-48
4.5.3.4	Pre-lay Surveys	4-48
4.5.4	Cable Installation	4-48
4.5.5	Export Cable Jointing	4-53
4.5.6	Cable Pull-In and Commissioning	4-54

## TABLE OF CONTENTS (CONTINUED)

---

4.5.7	Cable Protection	4-54
4.5.8	Cable Crossings	4-56
4.5.9	Post-Construction Surveys	4-57
4.5.10	Summary of Area of Potential Seabed Disturbance	4-58
4.5.10.1	Export Cables	4-58
4.5.10.2	Inter-Array and Inter-Link Cables	4-61
4.6	Meteorological Tower and Metocean Buoys	4-63
4.6.1	Permanent Met Tower	4-63
4.6.2	Temporary Metocean Buoys	4-65
4.7	Landfall Sites	4-65
4.7.1	Landfall Site Construction Activities	4-66
4.8	Onshore Interconnection Cables and Points of Interconnection	4-69
4.8.1	Cardiff Onshore Interconnection Cable Route	4-70
4.8.2	Larrabee Onshore Interconnection Cable Route	4-72
4.8.3	Cable Design and Construction Activities	4-74
4.9	Onshore Substations	4-76
4.9.1	Description of Onshore Substation Sites	4-76
4.9.2	Onshore Substation Design and Construction	4-76
4.10	Proposed Construction Vessels, Vehicles, and Aircraft	4-81
4.10.1	Offshore Construction	4-81
4.10.2	Onshore Construction	4-87
4.10.3	Construction Port Facilities and Staging Areas	4-87
4.11	Summary of Maximum Design Scenario and Seafloor Disturbance	4-99
<b>5.0</b>	<b>OPERATIONS AND MAINTENANCE</b>	<b>5-1</b>
5.1	Monitoring and Control Systems	5-1
5.2	Communication Systems	5-2
5.3	Lighting and Marking	5-3
5.4	Operations, Maintenance, and Inspections	5-4
5.4.1	WTGs	5-5
5.4.2	OSS Topsides	5-5
5.4.3	Foundations and Scour Protection	5-6
5.4.4	Offshore Cables	5-6
5.4.5	Onshore Substations and Onshore Interconnection Cables	5-6
5.4.6	Representative Inspection and Maintenance Schedule	5-7
5.5	O&M Facility and Ports	5-8
5.6	Proposed Vessels, Vehicles, and Aircraft	5-9

## TABLE OF CONTENTS (CONTINUED)

---

<b>6.0</b>	<b>DECOMMISSIONING</b>	<b>6-1</b>
6.1	Decommissioning Requirements	6-1
6.2	Decommissioning Activities	6-1
6.2.1	WTGs	6-2
6.2.2	Offshore Substations	6-2
6.2.3	WTG and OSS Foundations	6-2
6.2.4	Offshore Cables	6-3
6.2.5	Met Tower	6-3
6.2.6	Onshore Facilities	6-3
6.3	Financial Assurance for Decommissioning	6-3
<b>7.0</b>	<b>CHEMICAL PRODUCTS AND SOLID AND LIQUID WASTES</b>	<b>7-1</b>
<b>8.0</b>	<b>REFERENCES</b>	<b>8-1</b>

### List of Appendices

---

Appendix I-A	Preliminary Area of Potential Effects (PAPE) Memorandum
Appendix I-B	Engagement with Agencies, Tribes, Municipalities, and Other Stakeholders
Appendix I-C	Coastal Zone Management Consistency Statement
Appendix I-D	Draft Oil Spill Response Plan
Appendix I-E	Draft HSSE Safety Management System

### List of Figures

---

Figure E-1	Overview of the Projects	E-3
Figure 1.1-1	Atlantic Shores Lease Area OCS-A 0499 Offshore New Jersey	1-2
Figure 1.1-2	Overview of the Projects	1-4
Figure 1.1-3	Bathymetric Overview	1-5
Figure 1.2-1	BOEM Lease Areas in Proximity to New Jersey	1-11
Figure 3.1-1	WTA Layout	3-3
Figure 3.1-2	Offshore Substation Locations	3-4
Figure 3.1-3	Automatic Identification System (AIS) Fishing Vessel Traffic Offshore New Jersey	3-7
Figure 3.2-1	Onshore Interconnection Cable Routing Analysis	3-10
Figure 3.2-2	Preferred Onshore Interconnection Cable Routes	3-12
Figure 3.3-1	Preliminary Export Cable Routing Analysis	3-13
Figure 3.3-2	Preferred Export Cable Routes	3-15
Figure 3.5-1	Wind Turbine Generator Size Projections	3-18



## List of Figures (Continued)

---

Figure 4.1-1	General Project Construction Sequence	4-4
Figure 4.2-1	Piled Foundations	4-6
Figure 4.2-2	Piled Foundation Transportation and Installation	4-8
Figure 4.2-3	Suction Bucket Foundations	4-11
Figure 4.2-4	Suction Bucket Foundation Transportation and Installation	4-12
Figure 4.2-5	Gravity Foundations	4-14
Figure 4.2-6	Gravity Foundation Transportation and Installation	4-16
Figure 4.2-7	Installation and Transportation Aid	4-17
Figure 4.3-1	Wind Turbine Generator PDE	4-26
Figure 4.3-2	Representative WTG Transportation and Installation	4-28
Figure 4.4-1	Multi-Leg Gravity-Base Structure (GBS) Foundation	4-31
Figure 4.4-2	Offshore Substation Installation	4-37
Figure 4.5-1	High Voltage Alternating Current (HVAC) Export Cable Schematic	4-39
Figure 4.5-2	High Voltage Direct Current (HVDC) Export Cable Schematic	4-40
Figure 4.5-3	Inter-Array and Inter-Link Cable Schematic	4-42
Figure 4.5-4	Atlantic Export Cable Corridor (ECC)	4-43
Figure 4.5-5	Monmouth Export Cable Corridor (ECC)	4-44
Figure 4.5-6	Sand Bedform Removal Methodologies	4-47
Figure 4.5-7	Representative Pre-lay Grapnel Train Schematic	4-49
Figure 4.5-8	Offshore Cable Installation	4-52
Figure 4.5-9	Representative Cable Entry Protection System	4-55
Figure 4.5-10	Cable Crossings	4-57
Figure 4.6-1	Potential Met Tower and Metocean Buoy Locations	4-64
Figure 4.6-2	Representative Met Tower Schematic	4-66
Figure 4.6-3	Representative Metocean Buoy Schematic	4-67
Figure 4.8-1	Atlantic Landfall Site, Cardiff Onshore Interconnection Cable Route, and Onshore Substation Sites in Atlantic County, New Jersey	4-71
Figure 4.8-2	Monmouth Landfall Site, Larrabee Onshore Interconnection Cable Route, and Onshore Substation Sites in Monmouth County, New Jersey	4-73
Figure 4.9-1	Onshore Substation Sites for the Cardiff Onshore Interconnection Cable Route	4-77
Figure 4.9-2	Onshore Substation Sites for the Larrabee Onshore Interconnection Cable Route	4-78
Figure 4.10-1	Potential Construction Ports in the U.S.	4-98
Figure 5.6-1	Crew Transfer Vessel (CTV) and Service Operation Vessel (SOV) Examples	5-11

## List of Tables

---

Table E-1	Key Elements of the PDE	E-5
Table 1.1-1	Key Elements of the PDE	1-8
Table 1.3-1	Required Permits/Approvals for Atlantic Shores Projects	1-14
Table 1.3-2	Compliance with Stipulations in Lease Agreement OCS-A 0499	1-25
Table 1.3-3	COP Requirements for Commercial Leases Pursuant to 30 CFR §§ 585.105(a), 621(a-g), 626(a) and (b), 627(a-d)	1-29
Table 3.2-1	Potential Points of Interconnection	3-8
Table 3.2-2	Landfall Sites	3-9
Table 4.1-1	Anticipated Project 1 Construction Schedule	4-3
Table 4.2-1	PDE of WTG Foundations Dimensions and Seabed Disturbance	4-21
Table 4.3-1	PDE of WTG Dimensions	4-24
Table 4.3-2	Maximum Seabed Disturbance from WTG Installation	4-27
Table 4.4-1	OSS Foundation Types	4-29
Table 4.4-2	PDE of OSS Foundation Dimensions and Seabed Disturbance	4-32
Table 4.4-3	PDE of OSS Topside Dimensions	4-34
Table 4.4-4	Maximum Seabed Disturbance from OSS Topside Installation and Commissioning	4-36
Table 4.5-1	Maximum Seabed Disturbance from Export Cable Installation	4-58
Table 4.5-2	Maximum Seabed Disturbance from Inter-Array and Inter-Link Cable Installation	4-61
Table 4.9-1	Onshore Substation Parcel Dimensions	4-80
Table 4.10-1	Representative Offshore Construction Vessels	4-82
Table 4.10-2	Ports that May be Used During Construction of the Projects	4-88
Table 4.11-1	Maximum Total Seabed Disturbance for the Projects	4-101
Table 4.11-2	Maximum Total Seabed Disturbance for Project 1	4-104
Table 4.11-3	Maximum Total Seabed Disturbance for Project 2	4-107
Table 5.4-1	Schedule of Planned Preventive Maintenance Activities	5-7
Table 7.0-1	List of Potential Chemical Products Used for WTGs	7-2
Table 7.0-2	List of Potential Chemical Products Used for OSSs	7-3
Table 7.0-3	List of Potential Chemical Products Used for Onshore Substations	7-4

## List of Acronyms and Abbreviations

---

ACE	Atlantic City Electric
ACP	American Clean Power Association
ACPARS	Atlantic Ocean Port Access Routing Study
AHTS	Anchor Handling Tug Supply
AIS	Automatic Identification System
ADLS	Aircraft Detection Lighting System
APE	Area of Potential Effect
API	American Petroleum Institute
BMP	best management practice
BOEM	Bureau of Ocean Energy Management
CFR	Code of Federal Regulations
CO <sub>2</sub> e	carbon dioxide equivalent
COP	Construction and Operations Plan
CTV	crew transfer vessel
CVA	Certified Verification Agent
CWA	Clean Water Act
CZMA	Coastal Zone Management Act
DAS	distributed acoustic sensing
DCR	Discharge Cleanup and Removal
DLRP	Division of Land Resource Protection
DoD	Department of Defense
DOI	Department of Interior
DP	dynamic positioning
DPCC	Discharge Prevention, Containment, and Countermeasure
DTS	distributed temperature system
EA	Environmental Assessment
ECC	Export Cable Corridor
ECO	Educational and Community Outreach
eNGO	environmental non-governmental organization
EPA	Environmental Protection Agency
EPM	environmental protection measure
ESA	Endangered Species Act
FAA	Federal Aviation Administration
FCP	Fisheries Communication Plan
FDR	Facility Design Report
FIR	Fabrication and Installation Report
FIR	Fishing Industry Representative
FLO	Fisheries Liaison Officer
FONSI	Finding of No Significant Impact
FR	Federal Register

## List of Acronyms and Abbreviations (Continued)

---

FTE	full time equivalent
GBS	gravity-base structure
GCT	Global Container Terminal
GHG	greenhouse gases
GIS	geographic information systems
HAT	Highest Astronomical Tide
HDD	horizontal directional drilling
HDPE	high-density polyethylene
HLV	heavy lift vessel
HPO	Historic Preservation Office
HSSE	health, safety, security, and environmental
HTV	heavy transport vessel
HVAC	high voltage alternating current
HVDC	high voltage direct current
IEC	International Electrotechnical Commission
IHA	Incidental Harassment Authorization
ISO	International Organization for Standardization
JCP&L	Jersey Central Power & Light
LED	light-emitting diode
lidar	light detection and ranging
LOA	Letter of Authorization (LOA)
MEC	munitions and explosives of concern
met	meteorological
metocean	meteorological and oceanographic
MLLW	Mean Lower Low Water
MLW	Mean Low Water
MMPA	Marine Mammals Protection Act
MOTBY	Military Ocean Terminal Bayonne
MOU	memorandum of understanding
MRASS	Mariner Radio Activated Sound Signal
MSL	Mean Sea Level
NEPA	National Environmental Policy Act
NGTC	National Guard Training Center
NHPA	National Historic Preservation Act
NJWEA	New Jersey Wind Energy Area
NJBIA	New Jersey Business & Industry Association
NJBPU	New Jersey Board of Public Utilities
NJDEP	New Jersey Department of Environmental Protection
NJDOT	New Jersey Department of Transportation

## List of Acronyms and Abbreviations (Continued)

---

NMFS	National Marine Fisheries Service
NOx	nitrogen oxides
NOAA	National Oceanic and Atmospheric Administration
NPDES	National Pollutant Discharge Elimination System
NRDC	Natural Resources Defense Council, Inc.
NSRA	Navigation Safety Risk Assessment
O&M	operations and maintenance
OCS	Outer Continental Shelf
OEM	original equipment manufacturer
OLPD	online partial discharge
OREC	Offshore Renewable Energy Credit
OSHA	Occupational Safety and Health Administration
OSRP	Oil Spill Response Plan
OSS	offshore substation
OWPEBS	Ocean/Wind Power Ecological Baseline Studies
PANYNJ	Port Authority of New York and New Jersey
PATON	Private Aid to Navigation
PDE	Project Design Envelope
PLGR	pre-lay grapnel run
PM <sub>2.5</sub>	fine particulate matter (2.5 microns or smaller)
PNCT	Port Newark Container Terminal
POI	point of interconnection
PVC	polyvinyl chloride
RNA	rotor nacelle assembly
ROD	Record of Decision
RODA	Responsible Offshore Development Alliance
ROSA	Responsible Offshore Science Alliance
ROV	remotely-operated vehicle
ROW	right-of-way
RUCOOL	Rutgers University Center for Ocean Observing Leadership
SAP	Site Assessment Plan
SAR	search and rescue
SATV	service accommodation and transfer vessel
SBMT	South Brooklyn Marine Terminal
SCADA	supervisory control and data acquisition
SF <sub>6</sub>	sulfur hexafluoride
SMS	Safety Management System
SO <sub>2</sub>	sulfur dioxide
SOV	service operation vessel

## List of Acronyms and Abbreviations (Continued)

---

SPCC	Spill Prevention, Control, and Countermeasure
SPMT	self-propelled modular transporters
STATCOM	static synchronous compensator
TBD	to be determined
Call	Call for Information and Nominations
TMP	Traffic Management Plan
TSHD	trailing suction hopper dredge
UPS	uninterruptible power supply
USACE	U.S. Army Corps of Engineers
USCG	U.S. Coast Guard
USFWS	U.S. Fish and Wildlife Service
VHF	very high frequency
VMS	Vessel Monitoring System
WTA	Wind Turbine Area
WTG	wind turbine generator
XLPE	cross-linked polyethylene

## Glossary

Term	Definition
The Projects	Atlantic Shores’ proposal to develop two offshore wind energy generation projects within the southern portion of Bureau of Ocean Energy Management (BOEM) Lease Area OCS-A 0499 comprised of up to 200 total wind turbine generators (WTGs) and up to 10 offshore substations (OSSs).
Atlantic Shores Project 1 (Project 1)	Project 1 is located in the southwestern portion of Lease Area OCS-A 0499 and consists of 105-136 WTGs and up to five OSSs.
Atlantic Shores Project 2 (Project 2)	Project 2 is located in the southeastern portion of Lease Area OCS-A 0499 and consists of the remaining 64-95 WTGs and up to five OSSs.
Overlap Area	The Overlap Area consists of 31 WTGs that could be included in either Project 1 or Project 2.
Atlantic Shores Offshore Wind, LLC (Atlantic Shores)	Atlantic Shores Offshore Wind, LLC is the owner and an affiliate of Atlantic Shores Project 1 Company and Atlantic Shores Project 2 Company.
Atlantic Shores Offshore Wind Project 1, LLC (Atlantic Shores Project 1 Company)	The owner and operator of Project 1.
Atlantic Shores Offshore Wind Project 2, LLC (Atlantic Shores Project 2 Company)	The owner and operator of Project 2.
Atlantic Shores Project Area (Project Area)  Offshore Project Areas  Onshore Project Areas	The combined onshore and offshore area where Atlantic Shores’ facilities are physically located.  The offshore area where Atlantic Shores’ facilities for the Projects are physically located.  The onshore area where Atlantic Shores’ facilities for the Projects are physically located.
Atlantic Shores Project Region (Project Region)  Offshore Project Region  Onshore Project Region	The larger region surrounding the Atlantic Shores Projects Area. The extent of the Project Region varies by resource.  The broader offshore geographic region that could be affected by Projects’ activities. The Offshore Project Region includes the Lease Area.  The broader onshore geographic region that could be affected by Projects’ activities, which could include entire towns, communities, counties, etc.

## Glossary (Continued)

Term	Definition
Area of Potential Effect (APE)	The APE is defined in 36 CFR §800.16 as “the geographic area or areas within which an undertaking may directly or indirectly cause alterations in the character or use of historic properties, if any such properties exist.”
Cable protection	Material (e.g., rock, concrete mattresses, etc.) placed over an offshore cable to prevent damage to the cable.
Construction staging activities	Activities conducted in port such as component fabrication and assembly; offloading and loading shipments of Project components; storing Project components; preparing Project components for installation; and/or preparing vessels to tow floating components to the WTA.
Crew transfer vessel (CTV)	A relatively small vessel used to transfer crew and supplies from port to the Offshore Project Area.
Duct bank	The underground structure that houses onshore interconnection cables and consists of high-density polyethylene (HDPE) or polyvinyl chloride (PVC) conduits encased in concrete.
Export cable	A submarine transmission cable that is buried beneath the seafloor and connects an OSS to a landfall site.
Export Cable Corridor (ECC)	The area identified for routing the export cables between a landfall site and the WTA.
Atlantic ECC	The ECC that travels from the western tip of the WTA westward to the Atlantic Landfall Site.
Monmouth ECC	The ECC that travels from the eastern corner of the WTA along the eastern edge of Lease Area OCS-A 0499 to the Monmouth Landfall Site.
Fisheries Communication Plan (FCP)	A plan that defines outreach and engagement with fishing interests throughout the Project’s lifecycle.
Foundation	A steel and/or concrete structure that supports a WTG, OSS, or met tower and is affixed to the seabed using piles, suction buckets, or gravity.
Gravity-base structure (GBS)	A type of foundation consisting of a heavy steel-reinforced concrete and/or steel structure that sits on the seabed.
Gravity-pad tetrahedron base	A type of foundation that is comprised of a tetrahedral-shaped (i.e., three-legged pyramidal) frame that rests on the seabed and is secured in place using high weight pads (i.e., gravity pads) below each leg.
Horizontal directional drilling (HDD)	A trenchless cable installation methodology that avoids surface disturbance by drilling a pilot hole, enlarging the pilot hole, then inserting a conduit for future installation of cables.
Inter-array cables	Submarine transmission cables that connect groups of WTGs to an OSS.
Inter-link cable	A submarine transmission cable that may be used to connect OSSs together.



## Glossary (Continued)

Term	Definition
Jacket	A type of foundation with three to six legs that are secured to the seafloor using piles or suction buckets at the base of each leg.
Landfall site	A shoreline site where the export cables transition from offshore to onshore.
Atlantic Landfall Site	The shoreline site in Atlantic City, New Jersey where export cables installed in the Atlantic ECC transition onshore.
Monmouth Landfall Site	The shoreline site in Sea Girt, New Jersey (Monmouth County) where export cables installed in the Monmouth ECC transition onshore.
Lease Area OCS-A 0499 (Lease Area)	The entire Lease Area OCS-A 0499 that Atlantic Shores acquired from BOEM.
New Jersey Wind Energy Area (NJWEA)	The area offshore New Jersey identified as suitable for offshore renewable energy development by BOEM through a multi-year, public environmental review process.
Marshalling port	Ports where Project components will be offloaded, stored, pre-assembled, and prepared for load-out.
Meteorological and oceanographic (metocean) buoy	Buoys temporarily installed in the WTA to monitor weather and sea state conditions during construction.
Meteorological (met) tower	A tower permanently installed in the WTA to measure meteorological conditions during construction and operations.
Monopile	A type of foundation consisting of a single steel tube that is driven into the seabed.
Mono-bucket	A type of foundation comprised of a single suction bucket supporting a single steel or concrete tubular structure (similar to a monopile).
Offshore cable system	All offshore transmission cables (inter-array cables, inter-link cables, and export cables).
Offshore facilities	All of the Project's offshore infrastructure (WTGs, OSSs, offshore cables, etc.).
Offshore substation (OSS)	An OSS located in the WTA containing transformers and other electrical gear, which will serve as a common collection point for power from the WTGs and also serve as the origin for the export cables that deliver power to shore.
Onshore interconnection cable	An onshore transmission cable installed within a buried duct bank that connects a landfall site to an onshore substation and subsequently the onshore substation to a POI.

## Glossary (Continued)

Term	Definition
Onshore interconnection cable route	The onshore routes within which the onshore interconnection cables will be installed.
Cardiff Onshore Interconnection Cable Route	The onshore route that connects the Atlantic Landfall Site to the existing Cardiff Substation POI.
Larrabee Onshore Interconnection Cable Route	The onshore route that connects the Monmouth Landfall Site to the existing Larrabee Substation POI.
Onshore facilities	All of the Project's onshore infrastructure (onshore substations, onshore interconnection cables, etc.).
Onshore substation	A landside substation constructed for Atlantic Shores containing transformers and other electrical gear where the onshore interconnection cable voltage will be increased or decreased in preparation for grid interconnection.
Onshore substation site	A parcel of land where an onshore substation may be located.
Operations and maintenance (O&M) facility	A new O&M facility in Atlantic City established by Atlantic Shores to host its O&M personnel, dock vessels, and store equipment, tools, spare parts, and consumables.
Piled jacket	A type of foundation consisting of a steel lattice structure that is fixed to the seabed using piles connected to each leg of the jacket.
Point of interconnection (POI)	An existing substation where the Projects' onshore interconnection cables will interconnect into the electrical grid.
Cardiff POI	An existing substation located in Egg Harbor Township, New Jersey (Atlantic County).
Larrabee POI	An existing substation located in Howell, New Jersey (Monmouth County).
Port facilities	Facilities and infrastructure located within/adjacent to a port that will be used by Atlantic Shores during construction and operations.
Project Design Envelope (PDE)	The PDE identifies a reasonable range of designs for proposed components and installation techniques for the Projects.
Scour protection	Material (e.g., rock, concrete mattresses, etc.) placed around the base of a foundation to protect it from sediment transport/erosion caused by water currents.
Suction bucket jacket	A type of foundation consisting of a steel lattice structure that is fixed to the seabed by suction buckets installed below each leg of the jacket.
Suction bucket tetrahedron base	A type of foundation that is comprised of a tetrahedral-shaped (i.e., three-legged pyramidal) frame that rests on the seabed and is secured to the seafloor using suction buckets.

## Glossary (Continued)

---

Term	Definition
Wind Turbine Area (WTA)	The southern portion of Lease Area OCS-A 0499 that will be developed by Atlantic Shores for offshore wind energy generation as described in this COP.
Service operation vessel (SOV)	A relatively large vessel that offers considerable capacity for personnel and spare parts, allowing for service trips that are several weeks in duration. An SOV includes sleeping quarters for technicians and may include workshop space.
Splice vault	An underground concrete “box” where segments of the onshore interconnection cable are joined together.
Transition piece	A part of the foundation structure that contains a flange for connection to the WTG tower and may include secondary structures such as a boat landing, ladders, a work platform, a crane, and other ancillary components. A transition piece may be installed on top of a monopile, mono-bucket, or GBS foundation.
Transition vault	A type of splice vault located at a landfall site where the export cables are connected to the onshore interconnection cables.
Utility right-of-way (ROW)	Previously disturbed corridors that contain existing electric transmission lines or other utilities.
Wind turbine generator (WTG)	An offshore wind turbine that will generate electricity.

## 1.0 Introduction

Atlantic Shores Offshore Wind, LLC (Atlantic Shores), is a 50/50 joint venture between EDF-RE Offshore Development, LLC (a wholly owned subsidiary of EDF Renewables, Inc. (EDF Renewables)) and Shell New Energies US LLC (Shell). Atlantic Shores is proposing to develop two offshore wind energy generation projects within the southern portion of Lease Area OCS-A 0499 (the Lease Area). The Lease Area is approximately 183,253 acres (741.6 square kilometers [km<sup>2</sup>]) in size and is located on the Outer Continental Shelf (OCS) within the New Jersey Wind Energy Area (NJWEA) (see Figure 1.1-1). The NJWEA was identified as suitable for offshore renewable energy development by the Bureau of Ocean Energy Management (BOEM) through a multi-year, public environmental review process. Through this review process, the NJWEA was sited to exclude areas of high value habitat and conflicting water and air space uses (see Section 1.3.1).

In accordance with the New Jersey Offshore Wind Economic Development Act (OWEDA), on June 30, 2021, the New Jersey Board of Public Utilities (NJ BPU) awarded Atlantic Shores an Offshore Renewable Energy Credit (OREC) allowance to deliver 1,510<sup>4</sup> megawatts (MW) of offshore renewable energy into the State of New Jersey. The project that will be developed under this OREC award, referred to as Project 1, will be owned and operated by Atlantic Shores Offshore Wind Project 1, LLC (“Atlantic Shores Project 1 Company”). Pursuant to New Jersey Executive Orders #8 and #92, the State will be awarding additional OREC allowances to offshore wind energy projects through a competitive solicitation process every 2 years through 2026. Atlantic Shores expects to bid into these future New Jersey offshore wind energy solicitations for subsequent projects. Atlantic Shores’ second project, referred to as Project 2, will be owned and operated by Atlantic Shores Offshore Wind Project 2, LLC (“Atlantic Shores Project 2 Company”), is being developed to support these future New Jersey solicitations. Project 1 and Project 2 are collectively referred to as “the Projects.”

Atlantic Shores Offshore Wind, LLC is the owner and an affiliate of Atlantic Shores Project 1 Company and Atlantic Shores Project 2 Company. Accordingly, for ease of reference, the term “Atlantic Shores” is used throughout the COP to refer interchangeably to the Project Companies.

At the time of this COP submission, in accordance with 30 CFR 585.106, 585.107, and 585.409, Atlantic Shores has requested the assignment of the Project 1 and Project 2 development areas within the Lease Area to Atlantic Shores Project 1 Company and Project 2 Company jointly.

This Construction and Operations Plan (COP) has been developed in accordance with 30 CFR Part 585 and the stipulations in Atlantic Shores’ Lease Agreement OCS-A 0499. Atlantic Shores is requesting BOEM’s review and authorization of the Projects in accordance with BOEM’s (2018) Project Design Envelope (PDE) guidance. The PDE described in this Volume of the COP provides

---

<sup>4</sup> The New Jersey Board of Public Utilities awarded a contract to Atlantic Shores for 1,509.6 MW, which solely for convenience is rounded up to 1,510 MW throughout the COP.

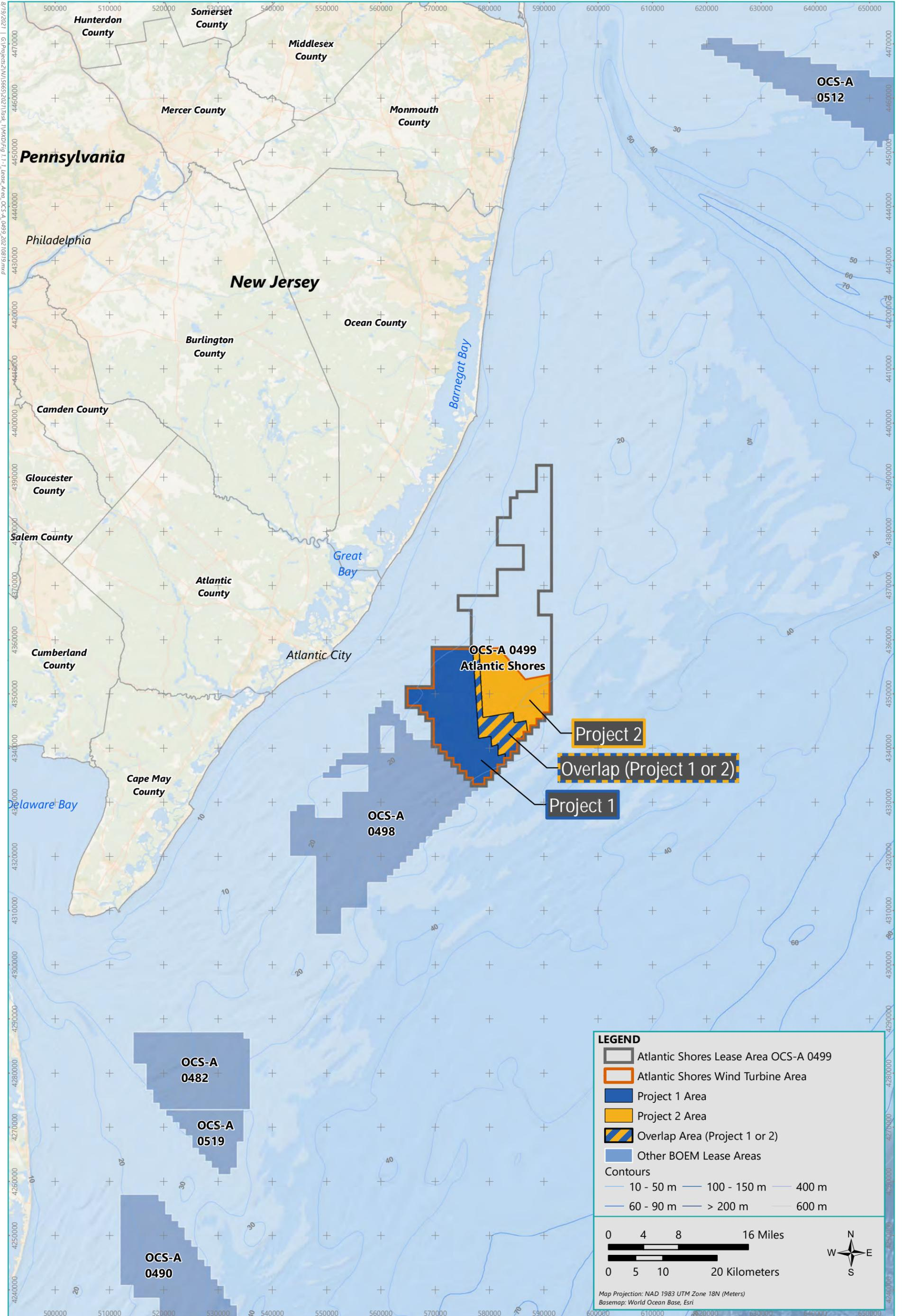

a reasonable range of designs for proposed components and installation techniques that provide Atlantic Shores optimal flexibility to adjust for rapidly-evolving offshore wind technology while providing BOEM with the information required to fulfill its expected role as the lead federal agency under the National Environmental Policy Act (NEPA). The COP will also inform the state and local regulatory processes. While this COP only describes the development of the southern portion of the Lease Area, Atlantic Shores maintains the right to develop the remainder of the Lease Area, which would be permitted under separate filings.

## 1.1 Overview of the Projects

Atlantic Shores' proposed offshore wind energy generation facilities for Projects 1 and 2 will be located in an approximately 102,124-acre (413.3-km<sup>2</sup>) Wind Turbine Area (WTA) located in the southern portion of the Lease Area. Project 1 is located in the western 54,175 acres (219.2 km<sup>2</sup>) of the WTA and Project 2 is located in the eastern 31,847 acres (128.9 km<sup>2</sup>) of the WTA, with a 16,102-acre (65.2-km<sup>2</sup>) Overlap Area that could be used by either Project 1 or Project 2. The Overlap Area is included in the event engineering or technical challenges arise at certain locations in the WTA, to provide flexibility for final selection of a wind turbine generator (WTG) supplier for the Projects (which will determine the final number of WTG positions needed for Project 1 and Project 2), and for environmental or other considerations. All positions in the Overlap Area are intended for development and are required to meet the Projects' purpose and need (see Section 1.2). Figures 1.1-2 and 1.1-3 provide an overview of the WTA, depicting the boundaries for Project 1, Project 2, and the Overlap Area.

In addition to the WTA, the Projects will include two offshore Export Cable Corridors (ECCs) within federal and New Jersey state waters as well as two onshore interconnection cable routes, two onshore substation sites, and a proposed operations and maintenance (O&M) facility in New Jersey. Figure 1.1-2 provides an overview of the Projects (i.e., the WTA, the ECCs, and onshore facilities).

At its closest point, the WTA is approximately 8.7 miles (mi) (14 kilometers [km]) from the New Jersey shoreline. As depicted on the location plat provided as Figure 1.1-2, water depths in the WTA range from 62 to 121 feet (ft) (19 to 37 meters [m]), gradually increasing with distance from shore. Within the WTA, the Projects will include:

- a combined maximum of up to 200 wind turbine generators (WTGs), inclusive of the Overlap Area<sup>5</sup>:
  - Project 1: a minimum of 105 WTGs and up to a maximum of 136 WTGs
  - Project 2: a minimum of 64 WTGs and up to a maximum of 95 WTGs

---

<sup>5</sup> The number of WTGs in Project 1, Project 2, and the associated Overlap Area will not exceed 200 WTG locations. For example, if Project 1 includes 105 WTGs (the minimum) then the Overlap Area would be incorporated into Project 2 which would include the remaining 95 WTGs; and conversely if the Overlap Area is incorporated into Project 1 such that it includes 136 WTGs, then Project 2 would be limited to 64 WTGs. Each Project may also use only part of the Overlap Area.

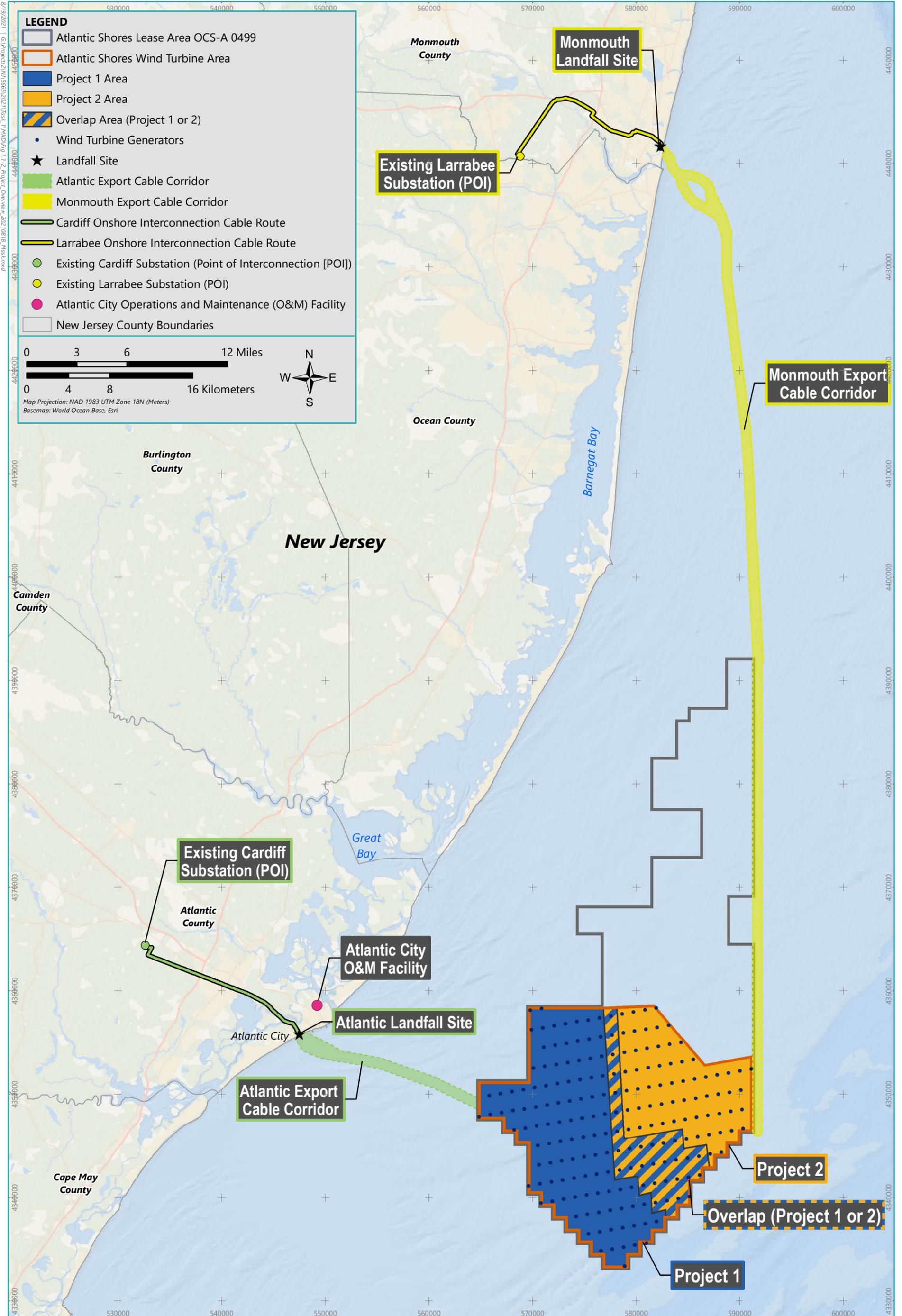

**Figure 1.1-2**  
Overview of the Projects

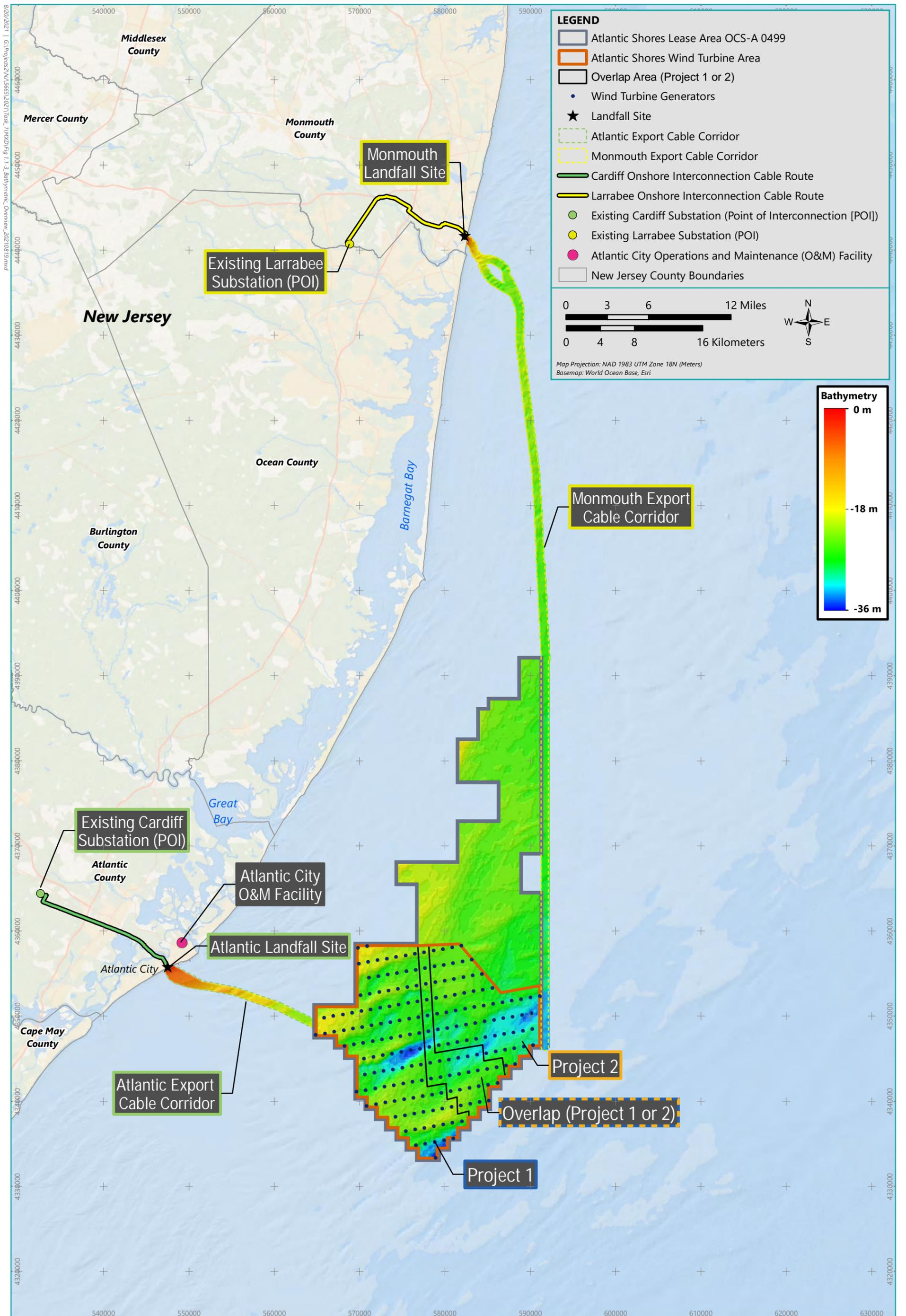

**LEGEND**

- Atlantic Shores Lease Area OCS-A 0499
- Atlantic Shores Wind Turbine Area
- Overlap Area (Project 1 or 2)
- Wind Turbine Generators
- ★ Landfall Site
- Atlantic Export Cable Corridor
- Monmouth Export Cable Corridor
- Cardiff Onshore Interconnection Cable Route
- Larrabee Onshore Interconnection Cable Route
- Existing Cardiff Substation (Point of Interconnection [POI])
- Existing Larrabee Substation (POI)
- Atlantic City Operations and Maintenance (O&M) Facility
- New Jersey County Boundaries

0 3 6 12 Miles  
0 4 8 16 Kilometers

Map Projection: NAD 1983 UTM Zone 18N (Meters)  
Basemap: World Ocean Base, Esri

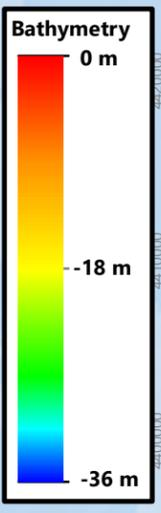



- up to 10 offshore substations (OSSs):
  - five for Project 1
  - five for Project 2
- up to one permanent meteorological (met) tower, to be installed during Project 1 construction
- up to four temporary meteorological and oceanographic (metocean) buoys:
  - three for Project 1
  - one for Project 2

The Projects include three options for WTG, OSS, and met tower foundations: piled, suction bucket, or gravity foundations.

Each Project's WTGs and OSSs will be connected by a system of 66 kilovolts (kV) to 150 kV high voltage alternating current (HVAC) inter-array cables. OSSs within the WTA may be connected to each other by 66 kV to 275 kV HVAC inter-link cables.

The Projects' layout is designed to maximize offshore renewable wind energy production while minimizing effects on existing marine uses (see Section 3.1). The WTGs for the Projects will be aligned in a uniform grid with multiple lines of orientation allowing straight transit through the WTA. The primary east-northeast to west-southwest transit corridors through the WTA were selected to align with the predominant flow of vessel traffic; accordingly, WTGs will be placed along east-northeast to west-southwest rows spaced 1.0 nautical mile (nm) (1.9 km) apart to allow for two-way vessel movement (see Figure 1.1-2). The proposed grid also facilitates north to south transit by positioning WTGs along rows in an approximately north to south direction spaced 0.6 nm (1.1 km) apart. The WTG grid will also create diagonal corridors of 0.54 nm (1.0 km) running approximately northwest to southeast as well as diagonal corridors of 0.49 nm (0.9 km) running approximately north-northeast to south-southwest. The OSS positions will be located along the same east-northeast to west-southwest rows as the proposed WTGs, preserving all of the primary east-northeast transit corridors and the majority of the secondary transit corridors (see Section 3.1).

Project 1 and Project 2 will be electrically distinct, and energy from the Projects' OSSs will be delivered to shore via 230 kV to 525 kV HVAC and/or high voltage direct current (HVDC) export cables. Thus, for the combined Projects, a total of up to eight export cables will be installed. The export cables will traverse federal and state waters to deliver energy from the OSSs to landfall sites in New Jersey. The Atlantic ECC travels from the western tip of the WTA westward to the Atlantic Landfall Site in Atlantic City, New Jersey and has a total length of approximately 12 mi (19 km). The approximately 61 mi (98 km) long Monmouth ECC travels from the eastern corner of the WTA along the eastern edge of the Lease Area to the Monmouth Landfall Site in Sea Girt, New Jersey. Water depths along each ECC are shown on Figure 1.1-2. Both Projects 1 and 2 have the potential to use either ECC and offshore export cables for each Project may also be co-located within an ECC.

At the Monmouth and Atlantic Landfall Sites, horizontal directional drilling (HDD) will be employed to support each export cables' offshore-to-onshore transition. The HDD landfall technique has been selected both to ensure stable cable burial along New Jersey's dynamic coast and to avoid nearshore and shoreline impacts. From each landfall site, up to 12 new 230 kV to 525 kV HVAC or HVDC onshore interconnection cables will travel underground primarily along existing roadways, utility rights-of-way (ROW), and/or along bike paths to two new onshore substation sites (one for each onshore point of interconnection [POI]). At the onshore substations, the transmission voltage will be stepped up or stepped down in preparation for interconnection with the electrical grid. Onshore interconnection cables will continue from each of the new onshore substations to proposed POIs where the Projects will be interconnected into the electrical grid at the existing Larrabee Substation in Howell, New Jersey (for the Monmouth Landfall Site) and the existing Cardiff Substation in Egg Harbor Township, New Jersey (for the Atlantic Landfall Site). Due to electrical capacity constraints at the POIs, two POIs are needed to accommodate the maximum amount of electricity that could be generated by the Projects.

During construction and operation of the Projects, Atlantic Shores will use port facilities in New Jersey, New York, the Mid-Atlantic, and/or New England. In addition, some components, materials, and vessels could come from U.S. Gulf Coast or international ports. To support the Projects' operations, Atlantic Shores is also proposing to establish an O&M facility at a port in New Jersey.

Key elements of the PDE are provided in Table 1.1-1.

## 1.2 Applicant's Purpose and Need

The purpose of the Projects is to develop offshore wind energy generation facilities within BOEM Lease Area OCS-A 0499 to provide clean, renewable energy to the Northeastern U.S. by the mid-to-late 2020s. As described in Section 2.0, the Projects will help both the U.S. and New Jersey achieve their renewable energy goals, diversify the State's electricity supply, increase electricity reliability, and reduce greenhouse gas emissions (GHGs). The Projects will also provide numerous environmental, health, community, and economic benefits and will create substantial new employment opportunities.

Presidential Executive Order 14008 (Tackling the Climate Crisis at Home and Abroad), signed on January 27, 2021, directs the Secretary of the Interior, in consultation with other federal agencies, to review siting and permitting processes to identify steps to double offshore wind energy production by 2030 (see Section 207; White House 2021). The State of New Jersey has also set ambitious renewable energy goals and mandates. New Jersey's Global Warming Response Act of 2007, as amended in 2019, mandates a reduction in the State's GHG emissions to 80% below its 2006 levels by 2050. New Jersey's renewable energy goals also include reaching 7,500 MW of offshore wind energy capacity by 2035, as outlined in the 2020 New Jersey Offshore Wind Strategic Plan, and achieving 100% clean energy by 2050, as described in the 2019 Energy Master Plan (Ramboll 2020; NJDEP 2020).

Table 1.1-1 Key Elements of the PDE

Element	Project Design Element	Total	Project 1	Project 2
WTGs	<b>Max. Number of WTGs</b>	200 (inclusive of the 31 WTGs in the Overlap Area) <sup>a</sup>	105-136	64-95
	<b>WTG Layout</b>	Grid layout with ENE/WSW rows and approximately N/S columns, consistent with the predominant flow of traffic		
	<b>Max. rotor diameter</b>	918.6 ft (280.0 m)		
	<b>Max. tip height<sup>b</sup></b>	1,048.8 ft (319.7 m)		
OSSs	<b>Max. Number of OSSs</b>	10 small OSSs, or	5	5
		5 medium OSSs, or	2	3
		4 large OSSs	2	2
	<b>OSS Layout</b>	Positioned along the same ENE/WSW rows as WTGs		
	<b>Min. Distance from Shore</b>	Small OSS: 12 mi (19.3 km) Medium and large OSS: 13.5 mi (21.7 km)		
WTG and OSS Foundations	<b>Foundation types</b>			
	<b>Piled</b>	Monopiles or piled jackets		
	<b>Suction bucket</b>	Mono-buckets, suction bucket jackets, or suction bucket tetrahedron bases <sup>c</sup>		
	<b>Gravity</b>	Gravity-base structures (GBS) or gravity-pad tetrahedron bases <sup>c</sup>		
	<b>Max. pile diameter at seabed (for piled foundation types)</b>	Monopile: 49.2 ft (15.0 m) Piled jacket: 16.4 ft (5.0 m)		
Inter-Array and Inter-Link Cables	<b>Cable types and voltage</b>	Inter-array: 66–150 kV high voltage alternating current (HVAC) Inter-link: 66–275 kV HVAC		
	<b>Max. Total Cable Length</b>	Inter-array: 547 mi (880 km)	273.5 mi (440 km)	273.5 mi (440 km)
		Inter-link: 37 mi (60 km)	18.6 mi (30 km)	18.6 mi (30 km)
	<b>Target burial depth range</b>	5 to 6.6 ft (1.5 to 2 m)		

Table 1.1-1 Key Elements of the PDE (Continued)

Element	Project Design Element	Total	Project 1	Project 2
Export Cables	Cable types and voltage	230–275 kV HVAC cables or 320–525 kV high voltage direct current (HVDC) cables		
	Number of ECCs	Two: Atlantic ECC and Monmouth ECC		
	Max. Number of Cables	8 total: HVAC or HVDC export cables		
	Max. Total Cable Length	Atlantic Landfall Site to OSSs: 99.4 mi (160.0 km) Monmouth Landfall Site to OSSs: 341.8 mi (550.0 km)		
	Target burial depth range	5 to 6.6 ft (1.5 to 2 m)		
Met Towers	Max. Number of Met Towers	Total: 1 (permanent)	1	0
Metocean Buoys	Max Number of Metocean Buoys	Total: 4 (Temporary, during construction)	3	1
Landfall Sites	Number of Landfall Sites	Atlantic Landfall Site		
		Monmouth Landfall Site		
	Installation Method	HDD		
Onshore Facilities	Number of Onshore Interconnection Cable Routes	Cardiff Onshore Interconnection Cable Route		
		Larrabee Onshore Interconnection Cable Route		
	Approx. route length	12 mi (19 km) each		
	Onshore interconnection cable types and voltage	230–275 kV HVAC cables installed in underground duct bank; or 320–525 kV HVDC cables installed in underground duct bank		
	Number of Onshore Substations	Total: two (one per POI), each with a preferred and an alternate site		
Points of Interconnection (POI)	Cardiff POI			
	Larrabee POI			
O&M Facility	Location	New operations and maintenance (O&M) facility proposed in Atlantic City, New Jersey		

Notes: a) The number of WTGs in Project 1, Project 2, and the associated Overlap Area will not exceed 200 WTG locations. For example, if Project 1 includes 105 WTGs (the minimum) then the Overlap Area would be incorporated into Project 2 which would include the remaining 95 WTGs; and conversely if the Overlap Area is incorporated into Project 1 such that it includes 136 WTGs then Project 2 would be limited to 64 WTGs. Each Project may also use only part of the Overlap Area.  
 b) All elevations are provided relative to Mean Lower Low Water (MLLW).  
 c) Tetrahedron base foundations are included in the PDE for WTGs but not OSSs.

Gray highlighting represents no differentiation between the Project Design Elements of Project 1 and Project 2

In accordance with New Jersey's renewable energy goals, on June 30, 2021, the NJ BPU awarded the Atlantic Shores Project 1 Company an OREC allowance to deliver approximately 1,510 MW of offshore renewable wind energy from Project 1 into the State of New Jersey. Project 1 will be developed under this OREC award. Pursuant to New Jersey Executive Orders #8 and #92, the State will be awarding additional OREC allowances to offshore wind energy projects through a competitive solicitation process conducted every 2 years through 2026. Project 2 is being developed to support these future New Jersey solicitations.

Currently, a limited number of BOEM offshore renewable wind energy lease areas can support both the U.S.' and New Jersey's ambitious renewable energy goals within the mandated timeframes. Atlantic Shores' Lease Area OCS-A 0499 is one of five lease areas in proximity to New Jersey (see Figure 1.2-1).<sup>6</sup> Of those lease areas, Lease Area OCS-A 0499 contains the largest uncommitted area<sup>7</sup> for renewable energy development to support both the national mandate for offshore wind and the State of New Jersey's ongoing and future renewable energy solicitations. Nearby lease areas—Lease Area OCS-A 0512 and portions of Lease Areas OCS-A 0498 and OCS-A 0519—are already associated with offshore wind projects that have received awards under offshore wind solicitations from the States of New York, New Jersey, and Maryland, respectively. In fact, without Atlantic Shores, it is unlikely that New Jersey's renewable energy targets can be fulfilled within the States' mandated timeframes.<sup>8</sup> More specifically, Project 1 is needed to meet Atlantic Shores Project 1 Company's obligations under its 1,510 MW OREC award and Project 2 is needed to respond to and fulfill the commitments that will be identified through New Jersey's ongoing renewable energy solicitations.

### 1.3 Leasing History and Regulatory Framework

This section provides a description of the regulatory framework for the Projects, including a history of BOEM's process to designate lease areas for wind energy development offshore New Jersey, and a description of the Projects' permitting process. This section also demonstrates the Projects' consistency with the requirements in Lease Agreement OCS-A 0499 and contains a guide to the location of information required in a COP pursuant to BOEM regulations codified at 30 CFR Part 585.

---

<sup>6</sup> The five BOEM lease areas situated proximate to New Jersey are Lease Areas OCS-A 0512, OCS-A 0499, OCS-A 0498, OCS-A 0482, and OCS-A 0519. BOEM has also established four Call Areas in the New York Bight region offshore New York and New Jersey, which are being evaluated for future lease area development. However, any timeframe for establishing those lease areas has not yet been determined.

<sup>7</sup> Lease Area OCS-A includes 183,253 acres. Of this total acreage, Project 1 will require a minimum of 54,175 acres, leaving up to 129,078 acres available for future wind energy developments, including Project 2.

<sup>8</sup> According to BOEM (2020), the technical capacity of the uncommitted portions of the lease areas offshore New York/New Jersey and Delaware/Maryland is 3,996 MW and 1,908 MW, respectively. Based on this assessment, Lease Area OCS-A 0499 serves a critical role in achieving the New Jersey target of 7,500 MW of offshore wind energy capacity by 2035.

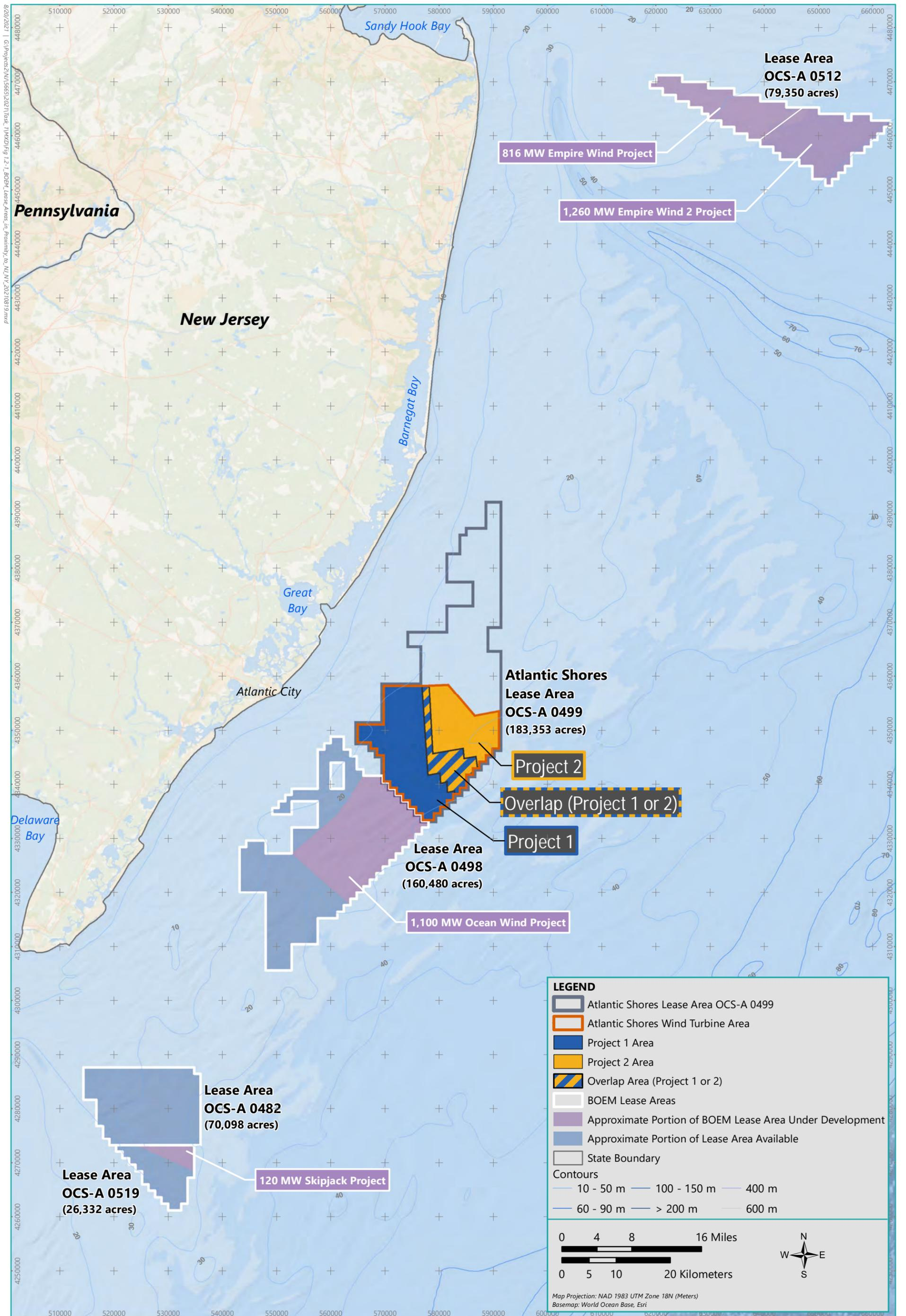

### 1.3.1 BOEM's New Jersey Offshore Wind Leasing Program

New Jersey has been planning for commercial-scale offshore wind development since the early 2000s. Early in this planning process, the NJBPU sponsored the 2004 *New Jersey Offshore Wind Energy: Feasibility Study* to investigate the feasibility of utility-scale wind energy development in the waters offshore of New Jersey. This desktop investigation characterized the geophysical, environmental, regulatory, and commercial siting considerations that would need to be addressed in order to develop New Jersey's offshore wind industry. Of the 2,465 square nautical miles (nm<sup>2</sup>) studied (from Sandy Hook to Egg Island Point and out to water depths of 100 ft [30 m]), approximately half (1,223 nm<sup>2</sup>) was deemed conditionally viable for offshore wind development after excluding areas with insufficient wind resources and conflicting water and air space uses (AREC and AWS 2004).

In 2004, the Governor of New Jersey authorized a State of New Jersey Blue Ribbon Panel on Development of Offshore Wind Turbine Facilities to identify and weigh the costs and benefits of developing offshore wind turbine facilities for New Jersey. The Blue Ribbon Panel's final report, submitted to the Governor in 2006, recommended that New Jersey conduct scientific baseline studies to collect data about the existence, location, and nature of New Jersey's offshore natural resources (see 76 FR 22130).

In response, the New Jersey Department of Environmental Protection (NJDEP) contracted Geo-Marine, Inc. to conduct Ocean/Wind Power Ecological Baseline Studies (OWPEBS) offshore New Jersey. The OWPEBS included 24 months of field studies in 2008 and 2009 to address data gaps on birds, sea turtles, marine mammals, and other natural resources. As part of the OWPEBS, desktop reviews of fish and fisheries resources in the 1,360 nm<sup>2</sup> study area were also conducted (GMI 2020).

The results of the OWPEBS field surveys and desktop analyses were instrumental in identifying suitable areas for siting future wind energy facilities offshore of New Jersey. Specifically, the results of the studies were used to delineate the New Jersey Call Area identified by BOEM in the "Commercial Leasing for Wind Power on the Outer Continental Shelf Offshore New Jersey – Call for Information and Nominations" (the "Call") published on April 20, 2011 (see 76 FR 22130). The purpose of the Call was to determine if competitive interest existed for the development of offshore wind generation facilities offshore New Jersey within the New Jersey Call Area. The New Jersey Call Area was delineated through consultation with the New Jersey Renewable Energy Task Force using the 1,360 nm<sup>2</sup> OWPEBS study area as a starting point. Areas of the OWPEBS study area excluded from the Call Area included (see 76 FR 22130):

- "no build areas" such as shipping lanes, traffic separation schemes, pipelines and cables, artificial reefs, and shipwrecks;
- areas of high avian density (particularly in shoals and within 7 nm of the New Jersey coast);
- areas of high marine mammal and sea turtle density; and
- fishing hotspots for recreational and commercial fishermen.

In addition, the Call gathered comments from interested and affected parties regarding site conditions, resources, or other uses within the area. BOEM received 11 commercial indications of interest to obtain a commercial lease for an offshore wind facility and numerous comments from the public.

In February 2012, BOEM published an Environmental Assessment (EA) and issued a Finding of No Significant Impact (FONSI) for commercial wind lease issuance and site assessment activities on the Atlantic OCS offshore New Jersey, Delaware, Maryland, and Virginia (see 77 FR 5560). As a result of subsequent discussions with the U.S. Coast Guard (USCG), the New Jersey Renewable Energy Task Force, and maritime stakeholders in December 2012, BOEM decided to remove certain OCS Lease Blocks from the area offshore New Jersey studied in the EA to alleviate navigational safety concerns resulting from vessel transits out of New York Harbor (see 79 FR 42361). This revised area constitutes the NJWEA. The NJWEA was divided into two leasing areas: Lease Area OCS-A 0498 and Lease Areas OCS-A 0499.

In September 2015, BOEM announced that it had published a Final Sale Notice for the sale of Lease Areas OCS-A 0498 and OCS-A 0499 (see 80 FR 57862); the competitive lease sale was held on November 9, 2015. U.S. Wind Inc. was the winning bidder for Lease Area OCS-A 0499 (see Figure 1.1-1). In December 2018, the Lease was assigned to EDF Renewables Development, Inc. The Lease was subsequently assigned to Atlantic Shores Offshore Wind, LLC in August 2019.

### 1.3.2 Permits, Approvals, and Consultations

BOEM has jurisdictional authority under the Outer Continental Shelf Lands Act of 1953, as amended by the Energy Policy Act of 2005, to grant leases, easements, and ROWs for the development of renewable energy on the OCS. BOEM will ensure that all activities conducted on the OCS are carried out in a manner that provides for safety, environmental protection, protection of national security interests, and protection of the rights of others to use the OCS and its resources. A Site Assessment Plan (SAP) and COP are the authorization pathways BOEM uses to review and approve renewable energy site assessment and site development on the OCS, respectively. BOEM will be the lead federal agency for the Projects and will coordinate with other federal agencies participating in consultations and/or issuing permits for the Projects (e.g., Environmental Protection Agency [EPA], National Marine Fisheries Services [NMFS], U.S. Army Corps of Engineers [USACE], Federal Aviation Administration [FAA]).

In reviewing the COP, BOEM must comply with various requirements under NEPA, Clean Air Act, Clean Water Act (CWA), Endangered Species Act (ESA), Magnuson-Stevens Fishery Conservation and Management Act, Migratory Bird Treaty Act, Bald and Golden Eagle Protection Act, Marine Mammals Protection Act (MMPA), and National Historic Preservation Act (NHPA). To facilitate BOEM's review under NHPA, a description of the Preliminary Area of Potential Effects (PAPE) is provided in Appendix I-A. BOEM will coordinate and consult with numerous other federal agencies, including NMFS, U.S. Fish and Wildlife Service (USFWS), EPA, the U.S. Department of



Defense (DoD), the USCG, and USACE during the review process. Under the Coastal Zone Management Act (CZMA), BOEM will coordinate with the State of New Jersey to ensure that the Projects are consistent with State-level coastal zone management plans.

Each Project’s onshore facilities and portions of the offshore facilities (within state waters extending approximately 3 nm from shore) will be located in the State of New Jersey and are also subject to state and local permitting processes.

Table 1.3-1 lists the anticipated federal, New Jersey, regional (county), and local reviews and permits required for the Projects; the table does not include permits that vessel operators or contractors may need to obtain for purposes that are not specific to construction and operation of the Projects. As appropriate, the Atlantic Shores Project Companies will file for separate applications to enable separate approvals for each Project. The Projects were accepted as a covered project under Title 41 of the Fixing America’s Surface Transportation Act (FAST-41) on April 13, 2021, and qualified for inclusion on the FAST-41 Permitting Dashboard. The permitting schedule below reflects the dates posted on the FAST-41 Permitting Dashboard as established by the Federal Permitting Improvement Steering Council (FPISC), which was created under FAST-41 with responsibility for overseeing interagency coordination during a covered project’s environmental review and decision making process.

Table 1.3-1 Required Permits/Approvals for Atlantic Shores Projects

Agency/ Regulatory Authority	Permit/Approval	Project 1 Submission Date	Project 1 Approval/ Completion Date	Project 2 Submission Date	Project 2 Approval/ Completion Date
<b>Federal Permits/Approvals<sup>9</sup></b>					
BOEM	SAP approval	12/6/19	Expected Q1 2021	N/A	N/A
	COP approval/Record of Decision (ROD)	3/25/2021	Expected Q3 2023	3/25/2021	Expected Q3 2023
	NEPA Environmental Review	9/30/2021	Expected Q3 2023	9/30/2021	Expected Q3 2023

<sup>9</sup> The status of Federal permits and approvals can be reviewed at the FAST-41 Permitting Dashboard: <https://www.permits.performance.gov/permitting-project/atlantic-shores-project-1>

Table 1.3-1 Required Permits/Approvals for Atlantic Shores Projects (Continued)

Agency/ Regulatory Authority	Permit/Approval	Project 1 Submission Date	Project 1 Approval/ Completion Date	Project 2 Submission Date	Project 2 Approval/ Completion Date
<b>Federal Permits/Approvals<sup>10</sup></b>					
BOEM	Consultation under Section 7 of the ESA with NMFS and USFWS, coordination with New Jersey under the CZMA, government-to-government tribal consultations, consultation under Section 106 of the NHPA, consultation with DoD, consultation with NMFS under the MMPA, and consultation with NMFS for Essential Fish Habitat	To be initiated by BOEM	Conducted concurrently with NEPA and COP review and approval process	To be initiated by BOEM	Conducted concurrently with NEPA and COP review and approval process
	Facility Design Report (FDR) and Fabrication and Installation Report (FIR)	Expected Q1 2024	Expected Q1 2024	Expected Q1 2024	Expected Q1 2024
EPA <sup>a</sup>	OCS Air Permit	6/1/2022	Expected Q 4 2023	6/1/2022	Expected Q4 2023

<sup>10</sup> The status of Federal permits and approvals can be reviewed at the FAST-41 Permitting Dashboard: <https://www.permits.performance.gov/permitting-project/atlantic-shores-project-1>

Table 1.3-1 Required Permits/Approvals for Atlantic Shores Projects (Continued)

Agency/ Regulatory Authority	Permit/Approval	Project 1 Submission Date	Project 1 Approval/ Completion Date	Project 2 Submission Date	Project 2 Approval/ Completion Date
<b>Federal Permits/Approvals</b>					
USACE	CWA Section 404 (required for discharge of dredged materials and placement of foundations, scour protection, and cable protection)	Joint application submission 10/15/2022	Expected Q4 2023	10/15/2022	Expected Q4 2023
	Rivers and Harbors Act of 1899 Section 10 Individual Permit (required for all offshore structures and dredging activities)				
	Section 103 of the Marine Protection, Research, and Sanctuaries Act (for dredged material disposal, if required)				
NMFS	Letter of Authorization (LOA) or Incidental Harassment Authorization (IHA)	3/1/2022	Expected Q4 2023	3/1/2022	Expected Q4 2023
USCG	Private Aid to Navigation (PATON) authorization	11/29/2023	Expected Q1 2024	5/29/2024	Expected Q3 2024
FAA	Determination of No Hazard to Air Navigation	3/29/2023 or 9/29/2023 (to avoid expiration)	Expected Q3 2024	3/29/2024	Expected Q1 2025
<b>State Permits/Approvals</b>					
NJBPU	Approval of Petition from electric distribution company for interconnection	To be determined (TBD) - local electric distribution company to file			

Table 1.3-1 Required Permits/Approvals for Atlantic Shores Offshore Wind (Continued)

Agency/ Regulatory Authority	Permit/Approval	Project 1 Submission Date	Project 1 Approval/ Completion Date	Project 2 Submission Date	Project 2 Approval/ Completion Date
<b>State Permits/Approvals</b>					
NJDEP, Division of Land Resource Protection (DLRP)	Waterfront Development Individual Permit – Water/Upland				
	Coastal Area Facility Review Act Permit				
	Coastal Wetlands Permit				
	CWA Section 401, State Water Quality Certificate	Joint application submission expected Q2 2022	Expected Q2 2023	Joint application submission expected Q2 2022	Expected Q2 2023
	Freshwater Wetlands General or Individual Permit				
	Flood Hazard Area Individual Permit or Verification				
	Dredging-related permits, as applicable				
Dredged material disposal permits, as applicable					

Table 1.3-1 Required Permits/Approvals for Atlantic Shores Offshore Wind (Continued)

Agency/ Regulatory Authority	Permit/Approval	Project 1 Submission Date	Project 1 Approval/ Completion Date	Project 2 Submission Date	Project 2 Approval/ Completion Date
<b>State Permits/Approvals</b>					
NJDEP, Division of Parks and Forestry, Natural Heritage Program	State Species Consultation	Initiated upon submittal of the NJDEP DLRP application	In conjunction with NJDEP review and approval (expected Q2 2023)	Initiated upon submittal of the NJDEP DLRP application	In conjunction with NJDEP review and approval (expected Q2 2023)
NJDEP, Historic Preservation Office (HPO)	Review Procedures under the New Jersey Register of Historic Places Act	Initiated prior to or upon submittal of the NJDEP DLRP application	In conjunction with NEPA review and NJDEP review and approval (expected Q2 2023)	Initiated prior to or upon submittal of the NJDEP DLRP application	In conjunction with NEPA review and NJDEP review and approval (expected Q2 2023)
	Consultation under Section 106 of the NHPA of 1966	Initiated prior to or upon submittal of the NJDEP DLRP application	In conjunction with NEPA review and NJDEP review and approval (expected Q2 2023)	Initiated prior to or upon submittal of the NJDEP DLRP application	In conjunction with NEPA review and NJDEP review and approval (expected Q2 2023)
NJDEP, Coastal Management Program	Concurrence with Federal Coastal Zone Consistency Determination	Expected Q2 2022 (to be filed in conjunction with the NJDEP DLRP application)	Expected Q2 2023	Expected Q2 2022 (to be filed in conjunction with the NJDEP DLRP application)	Expected Q2 2023
New Jersey Pinelands Commission	Application for Development	Expected Q2 2022 (to be filed in conjunction with the NJDEP DLRP application)	Expected Q2 2023	Expected Q2 2022 (to be filed in conjunction with the NJDEP DLRP application)	Expected Q2 2023

Table 1.3-1 Required Permits/Approvals for Atlantic Shores Offshore Wind (Continued)

Agency/ Regulatory Authority	Permit/Approval	Project 1 Submission Date	Project 1 Approval/ Completion Date	Project 2 Submission Date	Project 2 Approval/ Completion Date
<b>State Permits/Approvals</b>					
NJDEP, Bureau of Tidelands Management , Tidelands Resource Council	Tidelands License, Lease, or Grant	Expected Q2 2022 (to be filed in conjunction with the NJDEP DLRP application)	Expected Q2 2023	Expected Q2 2022 (to be filed in conjunction with the NJDEP DLRP application)	Expected Q2 2023
NJDEP, Department of Water Quality Bureau of Nonpoint Pollution Control	NJPDES 5G3 Stormwater General Construction Permit	To be filed within a few months of the start of construction	TBD	To be filed within a few months of the start of construction	TBD
Green Acres	Green Acres Diversion, if required	Expected Q2 2022 (to be filed in conjunction with the NJDEP DLRP application)	Expected Q2 2023 (highly dependent on when the next State House Commission meeting is held)	Expected Q2 2022 (to be filed in conjunction with the NJDEP DLRP application)	Expected Q2 2023 (highly dependent on when the next State House Commission meeting is held)
NJDEP, Water Allocation and Well Permitting	Water Use (dewatering during construction)		To be filed at least 30 days prior to dewatering activities	TBD	To be filed at least 30 days prior to dewatering activities
New Jersey Department of Transportatio n (NJDOT), Division of Right of Way and Access Management	Access Permits		Expected Q2 2022	Expected Q2 2023	Expected Q2 2022

Table 1.3-1 Required Permits/Approvals for Atlantic Shores Offshore Wind (Continued)

Agency/ Regulatory Authority	Permit/Approval	Project 1 Submission Date	Project 1 Approval/ Completion Date	Project 2 Submission Date	Project 2 Approval/ Completion Date
<b>Local Permits/Approvals</b>					
Atlantic County Department of Regional Planning and Development	Highway Occupancy Permit / Utility Permit	To be filed at least 90 days prior to start of construct-ion activities (expected Q2 2022)	Q4 2023	N/A	
Cape Atlantic Conservation District	Soil Erosion Sediment Control	To be filed at least 90 days prior to soil disturbance activities (expected Q2 2022)	Q4 2023	N/A	
Township of Egg Harbor	Zoning Permit	To be filed at least 12 months prior to start of construction activities (Q2 2022)	Q4 2023	N/A	
	Construction Permit	To be filed at least 90 days prior to soil disturbance activities (Q2 2022)	Q4 2023	N/A	
	Certificate of Occupancy	To be filed at least 90 days after construction is complete	TBD	N/A	
	Street Opening Permit	To be filed at least 90 days prior to soil disturbance activities (expected Q2 2022)	Q4 2023	N/A	

Table 1.3-1 Required Permits/Approvals for Atlantic Shores Offshore Wind (Continued)

Agency/ Regulatory Authority	Permit/Approval	Project 1 Submission Date	Project 1 Approval/ Completion Date	Project 2 Submission Date	Project 2 Approval/ Completion Date
<b>Local Permits/Approvals</b>					
		Site Plan Approval	To be filed at least 12 months prior to start of construction activities (Q2 2022)	Q4 2023	N/A
City of Pleasantville		Stormwater Control for Major Development (if required)	To be filed at least 12 months prior to start of construction activities (Q2 2022)	Q4 2023	N/A
		Street Opening Permit	To be filed at least 90 days prior to soil disturbance activities (expected Q2 2022)	Q4 2023	N/A
		Land Use/Zoning Permit	To be filed at least 12 months prior to start of construction activities (Q2 2022)	Q4 2023	N/A
City of Atlantic City		Zoning Permit	To be filed at least 12 months prior to start of construction activities (Q2 2022)	Q4 2023	N/A
		Stormwater Plan Approval	To be filed at least 12 months prior to start of construction activities (Q2 2022)	Q4 2023	N/A



Table 1.3-1 Required Permits/Approvals for Atlantic Shores Offshore Wind (Continued)

Agency/ Regulatory Authority	Permit/Approval	Project 1 Submission Date	Project 1 Approval/ Completion Date	Project 2 Submission Date	Project 2 Approval/ Completion Date
<b>Local Permits/Approvals</b>					
Freehold Soil Conservation District	Soil Erosion Sediment Control	N/A	N/A	To be filed at least 90 days prior to soil disturbance activities (expected Q2 2022)	Q4 2023
Monmouth County Highway Division of Inspections	Road Opening Permit	N/A	N/A	To be filed at least 90 days prior to start of construction activities (expected Q2 2022)	Q4 2023
	Site Plan Approval	N/A	N/A	To be filed at least 12 months prior to start of construction activities (Q2 2022)	Q4 2023
	Zoning Permit	N/A	N/A	To be filed at least 12 months prior to start of construction activities (Q2 2022)	Q4 2023
	Building Permit	N/A	N/A	To be filed at least 90 days prior to start of construction activities (expected Q2 2022)	Q4 2023

Table 1.3-1 Required Permits/Approvals for Atlantic Shores Offshore Wind (Continued)

Agency/ Regulatory Authority	Permit/Approval	Project 1 Submission Date	Project 1 Approval/ Completion Date	Project 2 Submission Date	Project 2 Approval/ Completion Date
<b>Local Permits/Approvals</b>					
	Site Development Stormwater Plan	N/A	N/A	To be filed at least 12 months prior to start of construction activities (Q2 2022)	Q4 2023
Township of Wall	Major Site Plan Approval	N/A	N/A	To be filed at least 12 months prior to start of construction activities (Q2 2022)	TBD
	Site Development Stormwater Plan	N/A	N/A	To be filed at least 12 months prior to start of construction activities (Q2 2022)	Q4 2023
	Development/Zoning Permit	N/A	N/A	To be filed at least 12 months prior to start of construction activities (Q2 2022)	Q4 2023
	Construction Permit	N/A	N/A	To be filed at least 90 days prior to start of construction activities (expected Q2 2022)	TBD

Table 1.3-1 Required Permits/Approvals for Atlantic Shores Offshore Wind (Continued)

Agency/ Regulatory Authority	Permit/Approval	Project 1 Submission Date	Project 1 Approval/ Completion Date	Project 2 Submission Date	Project 2 Approval/ Completion Date
<b>Local Permits/Approvals</b>					
	Tree Removal Plan	N/A	N/A	To be filed at least 90 days prior to start of construction activities (expected Q2 2022)	Q4 2023
	Conditional Permit	N/A	N/A	To be filed at least 12 months prior to start of construction activities (Q2 2022)	Q4 2023
	Street Opening Permit	N/A	N/A	To be filed at least 90 days prior to start of construction activities (expected Q2 2022)	Q4 2023
Township of Howell	Division of Land Use and Planning – Land Development Application	N/A	N/A	To be filed at least 12 months prior to start of construction activities (Q2 2022)	Q4 2023
	Division of Engineering – Plot Plan Approval	N/A	N/A	To be filed at least 12 months prior to start of construction activities (Q2 2022)	Q4 2023

Table 1.3-1 Required Permits/Approvals for Atlantic Shores Offshore Wind (Continued)

Agency/ Regulatory Authority	Permit/Approval	Project 1 Submission Date	Project 1 Approval/ Completion Date	Project 2 Submission Date	Project 2 Approval/ Completion Date
<b>Local Permits/Approvals</b>					
	Tree Removal Permit	N/A	N/A	To be filed at least 90 days prior to start of construction activities (expected Q2 2022)	Q4 2023

Notes:

Authority to issue the OCS Air Permit currently lies with EPA Region 2, but the State of New Jersey has taken actions towards obtaining delegated authority to issue and enforce OCS air permits. Per 40 CFR §52.11(b), that delegation can occur when New Jersey has demonstrated that the State has adopted the appropriate portions of the regulation into state law, and has adequate authority, resources, and administrative procedures to implement the regulation. New Jersey incorporated 40 CFR Part 55 into the NJDEP regulations (at NJAC 7:27-30) effective May 4, 2020.

### 1.3.3 Commercial Lease Stipulations and Compliance

Table 1.3-2 demonstrates how Atlantic Shores and the affiliate Project Companies are currently complying with or will comply with the stipulations outlined in Lease Agreement OCS-A 0499.

Table 1.3-2 Compliance with Stipulations in Lease Agreement OCS-A 0499

Stipulation	Compliance
<b>Section 4(a):</b> The Lessee must make all rent payments to the Lessor in accordance with applicable regulations in 30 CFR Part 585, unless otherwise specified in Addendum "B".	Atlantic Shores has made and will continue to make all rent payments in accordance with applicable regulations, unless otherwise specified in Addendum "B" of the Lease Agreement.
<b>Section 4(b):</b> The Lessee must make all operating fee payments to the Lessor in accordance with applicable regulations in 30 CFR Part 585, as specified in Addendum "B".	Atlantic Shores will make all operating fee payments in accordance with applicable regulations.

Table 1.3-2 Compliance with Stipulations in Lease Agreement OCS-A 0499 (Continued)

Stipulation	Compliance
<p><b>Section 5:</b> The Lessee may conduct those activities described in Addendum "A" only in accordance with a SAP or COP approved by the Lessor. The Lessee may not deviate from an approved SAP or COP except as provided in applicable regulations in 30 CFR Part 585.</p>	<p>Atlantic Shores will conduct activities as described in the approved SAP and COP.</p>
<p><b>Section 7:</b> The Lessee must conduct, and agrees to conduct, all activities in the leased area in accordance with an approved SAP or COP, and with all applicable laws and regulations.</p>	<p>Atlantic Shores will conduct all activities in the leased area in accordance with the approved SAP and COP and all applicable laws and regulations.</p>
<p><b>Section 10:</b> The Lessee must provide and maintain at all times a surety bond(s) or other form(s) of financial assurance approved by the Lessor in the amount specified in Addendum "B".</p>	<p>Atlantic Shores will provide the necessary financial assurances as described in Section 6.3 of Volume I of this COP.</p>
<p><b>Section 13:</b> Unless otherwise authorized by the Lessor, pursuant to the applicable regulations in 30 CFR Part 585, the Lessee must remove or decommission all facilities, projects, cables, pipelines, and obstructions and clear the seafloor of all obstructions created by activities on the leased area, including any project easements within two years following lease termination, whether by expiration, cancellation, contraction, or relinquishment, in accordance with any approved SAP, COP, or approved Decommissioning Application, and applicable regulations in 30 CFR Part 585.</p>	<p>Preliminary decommissioning plans are described in Section 6.2 of Volume I of this COP. Decommissioning will be conducted in accordance with the applicable regulations.</p>

Table 1.3-2 Compliance with Stipulations in Lease Agreement OCS-A 0499 (Continued)

Stipulation	Compliance
<p><b>Section 14:</b> The Lessee must:</p> <ul style="list-style-type: none"> <li>(a) Maintain all places of employment for activities authorized under this lease in compliance with occupational safety and health standards and, in addition, free from recognized hazards to employees of the Lessee or of any contractor or subcontractor under this lease;</li> <li>(b) Maintain all operations within the leased area in compliance with regulations in 30 CFR Part 585 and orders from the Lessor and other federal agencies with jurisdiction, intended to protect persons, property and the environment on the OCS; and</li> <li>(c) Provide any requested documents and records, which are pertinent to occupational or public health, safety, or environmental protection, and allow prompt access, at the site of any operation or activity conducted under this lease, to any inspector authorized by the Lessor or other federal agency with jurisdiction.</li> </ul>	<ul style="list-style-type: none"> <li>(a) Atlantic Shores has and will continue to maintain all places of employment in compliance with applicable occupational safety and health standards.</li> <li>(b) Atlantic Shores will maintain all operations within the lease area in compliance with applicable regulations.</li> <li>(c) Atlantic Shores will provide any requested documents and records that are pertinent to occupational or public health, safety, or environmental protection, and allow prompt access to the site of Project activities to authorized inspectors.</li> </ul>
<p><b>Section 15:</b> The Lessee must comply with the Department of the Interior’s Non-procurement debarment and suspension regulations set forth in 2 CFR Parts 180 and 1400 and must communicate the requirement to comply these regulations to persons with whom it does business related to this lease by including this requirement in all relevant contracts and transactions.</p>	<p>Atlantic Shores will comply with the applicable Department of Interior (DOI) non-procurement debarment and suspension regulations.</p>
<p><b>Section 16:</b> During the performance of this lease, the Lessee must fully comply with paragraphs (1) through (7) of section 2020 of Executive Order 11246, as amended (reprinted in 41 CFR 60-1.4(a)), and the implementing regulations, which are for the purpose of preventing employment discrimination against persons on the basis of race, color, religion, sex, or national origin.</p>	<p>Atlantic Shores will fully comply with paragraphs (1) through (7) of section 2020 of Executive Order 11246, as amended.</p>
<p>Addendum “B”, Section III (Payments): Unless otherwise authorized by the Lessor in accordance with the applicable regulations in 30 CFR Part 585, the Lessee must make payments as described below.</p>	<p>Atlantic Shores will make payments as specified in Addendum “B,” Section III.</p>

### 1.3.4 Guide to Location of Required Information for a COP

This COP, which has been developed in accordance with 30 CFR Part 585 and the stipulations in Atlantic Shores' Lease Agreement OCS-A 0499, is organized in two volumes:

- Volume I provides detailed descriptions of the Projects' offshore and onshore facilities and how the Projects plan to construct, operate, and decommission those facilities.
  - Section 1.0 provides an overview of the Projects and their purpose, describes the regulatory framework under which the Projects will be evaluated, summarizes Atlantic Shores' stakeholder outreach efforts, and details Atlantic Shores' commitment to health, safety, security, and environmental (HSSE) protection.
  - Section 2.0 describes the Projects' economic, community, environmental, and public health benefits.
  - Section 3.0 summarizes Atlantic Shores' siting process and explains how the PDE was developed.
  - Section 4.0 provides a detailed description of the Projects' PDE and proposed construction activities, including an overview of the Projects' construction schedule.
  - Section 5.0 describes Atlantic Shores' O&M activities, including surveys and inspections.
  - Section 6.0 provides the Projects' general decommissioning concept and describes financial assurance.
  - Section 7.0 describes the chemical products used and wastes generated by the Projects.

Volume II provides a comprehensive assessment of the Projects' potential effects to physical, biological, visual, cultural, and socioeconomic resources and describes the numerous measures that Atlantic Shores' will employ to avoid, minimize, and mitigate those potential effects. Volume II also characterizes the Projects' environmental setting.

Table 1.3-3 lists BOEM's requirements for a COP pursuant to 30 CFR Part 585 and the corresponding sections of this COP that provide the responsive information.

Table 1.3-3 COP Requirements for Commercial Leases Pursuant to 30 CFR §§ 585.105(a), 621(a-g), 626(a) and (b), 627(a-d)

Requirement	Location in COP
<b>30 CFR §585.105(a)</b>	
1) Design your projects and conduct all activities in a manner that ensures safety and will not cause undue harm or damage to natural resources, including their physical, atmospheric, and biological components to the extent practicable; and take measures to prevent unauthorized discharge of pollutants including marine trash and debris into the offshore environment.	Section 1.3.3 of Volume I Section 1.5.2 of Volume I Section 1.5.3 of Volume I Section 3.0 of Volume I Section 4.0 of Volume I Section 5.0 of Volume I Section 6.0 of Volume I Section 7.0 of Volume I Appendix I-D Appendix I-E Section 2.0 of Volume II Section 3.0 of Volume II Section 4.0 of Volume II Section 9.0 of Volume II Appendix II-J Appendix II-L
<b>30 CFR §585.621(a-g)</b>	
a) The projects will conform to all applicable laws, implementing regulations, lease provisions, and stipulations or conditions of the lease.	Section 1.3 of Volume I Section 1.5 of Volume I Section 4.0 of Volume I Section 5.0 of Volume I Section 6.0 of Volume I
b) The projects will be safe.	Section 1.3.3 (Table 1.3-2) of Volume I Section 1.5 of Volume I Appendix I-E Section 9.0 of Volume II
c) The projects will not unreasonably interfere with other uses of the OCS, including those involved with National security or defense.	Section 7.3 of Volume II Section 7.4 of Volume II Section 7.6 of Volume II Section 7.7 of Volume II Section 7.8 of Volume II Appendix II-R Appendix II-S Appendix II-T



Table 1.3-3 COP Requirements for Commercial Leases Pursuant to 30 CFR §§ 585.105(a), 621(a-g), 626(a) and (b), 627(a-d) (Continued)

Requirement	Location in COP
<b>30 CFR §585.621(a-g)</b>	
<p>d) The projects will not cause undue harm or damage to natural resources; life (including human and wildlife); property; the marine, coastal, or human environment; or sites, structures, or objects of historical or archaeological significance.</p>	<p>Section 2.0 of Volume II            Section 3.0 of Volume II            Section 4.0 of Volume II            Section 5.0 of Volume II            Section 6.0 of Volume II            Section 7.0 of Volume II            Section 8.0 of Volume II            Section 9.0 of Volume II            Appendix II-C            Appendix II-D            Appendix II-E            Appendix II-G            Appendix II-H            Appendix II-J            Appendix II-I            Appendix II-L            Appendix II-M            Appendix II-N            Appendix II-O            Appendix II-P            Appendix II-Q            Appendix II-S            Appendix II-T            Appendix II-U</p>
<p>e) The projects will use the best available and safest technology.</p>	<p>Section 1.3.3 of Volume I            Section 1.5.2 of Volume I            Section 1.5.3 of Volume I            Section 3.0 of Volume I            Section 4.0 of Volume I            Appendix I-E</p>
<p>f) The projects will use best management practices.</p>	<p>Section 2.0 of Volume II            Section 3.0 of Volume II            Section 4.0 of Volume II            Section 5.0 of Volume II            Section 6.0 of Volume II            Section 7.0 of Volume II            Section 9.0 of Volume II</p>

Table 1.3-3 COP Requirements for Commercial Leases Pursuant to 30 CFR §§ 585.105(a), 621(a-g), 626(a) and (b), 627(a-d) (Continued)

Requirement	Location in COP
<b>30 CFR §585.621(a-g)</b>	
g) The projects will use properly trained personnel.	Section 1.5.2 of Volume I Section 1.5.3 of Volume I Section 5.0 of Volume I Appendix I-E Section 9.0 of Volume II
<b>30 CFR §585.626(a)</b>	
<b>(1) Shallow Hazards</b>	
(i) Shallow faults;	Appendix II-A
(ii) Gas seeps or shallow gas;	Appendix II-A
(iii) Slump blocks or slump sediments;	Appendix II-A
(iv) Hydrates; or	Appendix II-A
(v) Ice scour of seabed sediments	Appendix II-A
<b>(2) Geological survey relevant to the design and siting of facility</b>	
(i) Seismic activity at your proposed site;	Appendix II-A
(ii) Fault zones;	Appendix II-A
(iii) The possibility and effects of seabed subsidence; and	Appendix II-A
(iv) The extent and geometry of faulting attenuation effects of geological conditions near your site.	Appendix II-A
<b>(3) Biological</b>	
(i) A description of the results of biological surveys used to determine the presence of live bottoms, hard bottoms, and topographic features, and surveys of other marine resources such as fish populations (including migratory populations), marine mammals, sea turtles, and sea birds.	Section 4.0 of Volume II Appendix II-F Appendix II-G Appendix II-J
<b>(4) Geotechnical Survey</b>	
(i) The results of a testing program used to investigate the stratigraphic and engineering properties of the sediment that may affect the foundations or anchoring systems for your facility.	Appendix II-A
(ii) The results of adequate <i>in situ</i> testing, boring, and sampling at each foundation location, to examine all important sediment and rock strata to determine its strength classification, deformation properties, and dynamic characteristics.	Appendix II-A

Table 1.3-3 COP Requirements for Commercial Leases Pursuant to 30 CFR §§ 585.105(a), 621(a-g), 626(a) and (b), 627(a-d) (Continued)

Requirement	Location in COP
<b>30 CFR §585.626(a)</b>	
(iii) The results of a minimum of one deep boring (with soil sampling and testing) at each edge of the project areas and within the project areas as needed to determine the vertical and lateral variation in seabed conditions and to provide the relevant geotechnical data required for design.	Appendix II-A
<b>(5) Archaeological Resources</b>	
(i) A description of the historic and prehistoric archaeological resources, as required by the National Historic Preservation Act (NHPA) (16 U.S.C. 470 et. seq.), as amended.	Section 6.0 of Volume II Appendix II-N Appendix II-O Appendix II-P Appendix II-Q
<b>(6) Overall Site Investigation</b>	
(i) Scouring of the seabed;	Appendix II-A
(ii) Hydraulic instability;	Appendix II-A
(iii) The occurrence of sand waves;	Appendix II-A
(iv) Instability of slopes at the facility location;	Appendix II-A
(v) Liquefaction, or possible reduction of sediment strength due to increased pore pressures;	Appendix II-A
(vi) Degradation of subsea permafrost layers;	Appendix II-A
(vii) Cyclic loading;	Appendix II-A
(viii) Lateral loading;	Appendix II-A
(ix) Dynamic loading;	Appendix II-A
(x) Settlements and displacements;	Appendix II-A
(xi) Plastic deformation and formation collapse mechanisms; and	Appendix II-A
(xii) Sediment reactions on the facility foundations or anchoring systems.	Appendix II-A
<b>30 CFR §585.626(b)</b>	
(1) Contact information	Section 1.5.1 of Volume I
(2) Designation of operator, if applicable	Section 1.5.1 of Volume I
(3) The construction and operation concept	Section 1.1 of Volume I Section 4.0 of Volume I Section 5.0 of Volume I

Table 1.3-3 COP Requirements for Commercial Leases Pursuant to 30 CFR §§ 585.105(a), 621(a-g), 626(a) and (b), 627(a-d) (Continued)

Requirement	Location in COP
<b>30 CFR §585.626(b)</b>	
(4) Commercial lease stipulations and compliance	Section 1.3.3 (Table 1.3-2) in Volume I
(5) A location plat	Section 1.1 (Figure 1.1-2) of Volume I
(6) General structural and project design, fabrication, and installation	Section 3.0 of Volume I Section 4.0 of Volume I
(7) All cables and pipelines, including cables on project easements	Section 1.3.1 of Volume I Section 4.5 of Volume I Section 4.7 of Volume I Section 4.8 of Volume I Section 5.4.4 of Volume I Section 5.4.5 of Volume I Section 5.4.6 of Volume I Section 6.2 of Volume I
(8) A description of the deployment activities	Section 1.5.3 of Volume I Section 4.0 of Volume I
(9) A list of solid and liquid wastes generated	Section 7.0 of Volume I
(10) A listing of chemical products used (if stored volume exceeds Environmental Protection Agency Reportable Quantities)	Section 7.0 of Volume I
(11) A description of any vessels, vehicles, and aircraft you will use to support your activities	Section 4.10 of Volume I Section 5.6 of Volume I
(12i) A general description of the operating procedures and systems under normal conditions	Section 5.0 of Volume I
(12ii) A general description of the operating procedures and systems in the case of accidents or emergencies, including those that are natural or manmade	Section 1.5.3 of Volume I Section 5.4 of Volume I Section 9.0 of Volume II Appendix I-D Appendix I-E
(13) Decommissioning and site clearance procedures	Section 6.0 of Volume I
(14i) A listing of all Federal, State, and local authorizations, approvals, or permits that are required to conduct the proposed activities, including commercial operations. The list should contain U.S. Coast Guard, U.S. Army Corps of Engineers, and any authorizations pertaining to energy gathering, transmission or distribution (e.g., interconnection authorizations).	Section 1.3 (Table 1.3-1) of Volume I

Table 1.3-3 COP Requirements for Commercial Leases Pursuant to 30 CFR §§ 585.105(a), 621(a-g), 626(a) and (b), 627(a-d) (Continued)

Requirement	Location in COP
<b>30 CFR §585.626(b)</b>	
(14ii) A listing of all Federal, State, and local authorizations, approvals, or permits that are required to conduct the proposed activities, including commercial operations, along with a statement indicating whether you have applied for or obtained such authorization, approval, or permit.	Section 1.3 (Table 1.3-1) of Volume I
(15) Your proposed measures for avoiding, minimizing, reducing, eliminating, and monitoring environmental impacts	Section 2.0 of Volume II Section 3.0 of Volume II Section 4.0 of Volume II Section 5.0 of Volume II Section 6.0 of Volume II Section 7.0 of Volume II
(16) Information you incorporate by reference	Section 8.0 of Volume I Section 10.0 of Volume II
(17) A list of agencies and persons with whom you have communicated, or with whom you will communicate, regarding potential impacts associated with our proposed activities	Section 1.4 of Volume I Appendix I-B
(18) Reference	Section 8.0 of Volume I Section 10.0 of Volume II
(19) Financial assurance	Section 6.3 of Volume I
(20) CVA nominations for reports required in subpart G of this part	Section 1.5.2 of Volume I
(21) Construction schedule	Section 4.1 (Table 4.1-1) of Volume I
(22) Air quality information	Section 3.1 of Volume II Appendix II-C
(23) Other information	Section 1.0 of Volume I Appendix II-B

Table 1.3-3 COP Requirements for Commercial Leases Pursuant to 30 CFR §§ 585.105(a), 621(a-g), 626(a) and (b), 627(a-d) (Continued)

Requirement	Location in COP
<b>30 CFR §585.627(a)</b>	
(1) Hazard information	Section 2.1.4 of Volume II Appendix II-A
(2) Water quality	Section 3.2 of Volume II
(3)(i) Benthic communities	Section 4.5 of Volume II Appendix II-G
(3)(ii) Marine mammals	Section 4.7 of Volume II
(3)(iii) Sea turtles	Section 4.8 of Volume II
(3)(iv) Coastal and marine birds	Section 4.3 of Volume II Appendix II-F
(3)(v) Fish and shellfish	Section 4.5 of Volume II Section 4.6 of Volume II Appendix II-G Appendix II-J
(3)(vi) Plankton	Section 4.6 of Volume II
(3)(vii) Seagrasses	Section 4.2 of Volume II Appendix II-E
(3)(viii) Plant life	Section 4.1 of Volume II Section 4.2 of Volume II
(4) Threatened or endangered species	Section 4.0 of Volume II
(5) Sensitive biological resources or habitats	Section 4.0 of Volume II Appendix II-D Appendix II-E Appendix II-G Appendix II-J
(6) Archaeological resources	Section 6.2 of Volume II Section 6.3 of Volume II Appendix II-P Appendix II-Q
(7) Social and economic resources	Section 7.0 of Volume II Appendix II-R

Table 1.3-3 COP Requirements for Commercial Leases Pursuant to 30 CFR §§ 585.105(a), 621(a-g), 626(a) and (b), 627(a-d) (Continued)

Requirement	Location in COP
<b>30 CFR §585.627(a)</b>	
(8) Coastal and marine uses	Section 7.3 of Volume II Section 7.4 of Volume II Section 7.5 of Volume II Section 7.6 of Volume II Section 7.7 of Volume II Appendix II-K Appendix II-R Appendix II-S
(9) Consistency certification	Appendix I-C
(10) Other resources, conditions, and activities	Section 7.8 of Volume II Section 7.9 of Volume II Section 8.0 of Volume II Section 9.0 of Volume I Appendix II-I Appendix II-T Appendix II-U
<b>30 CFR §585.627(b)</b>	
Consistency certification	Appendix I-C
<b>30 CFR §585.627(c)</b>	
Oil spill response plan	Section 1.5.3.2 of Volume I Appendix I-D
<b>30 CFR §585.627(d)</b>	
Safety management system	Section 1.5.3.1 of Volume I Appendix I-E

## 1.4 Agency and Stakeholder Outreach

### 1.4.1 Coordination with Agencies, Tribes, and Municipalities

Atlantic Shores proactively engages with federal, state, and local agencies to discuss development of the Lease Area, to present Project-specific details, to collaboratively identify resource issues of concern and mitigation strategies, and to design scientific research and monitoring studies that satisfy all regulatory review requirements. Atlantic Shores meets bi-weekly with key agencies,

including BOEM, USCG, and NJDEP, and has collaborated on research activities with other agencies (e.g., the red knot satellite tagging study with USFWS). Meetings held to date between agencies and Atlantic Shores are listed in Appendix I-B.

Atlantic Shores recognizes the importance of ensuring local elected officials are familiar with the Projects and their potential benefits and impacts to their constituents. Atlantic Shores has held meetings with local municipalities and leaders in Atlantic, Monmouth, and Ocean Counties in New Jersey (see Appendix I-B). These meetings with local officials have focused on introducing and soliciting input on PDE elements, the Projects' potential environmental effects, and opportunities aligned with local workforce development.

While engagement with the Narragansett Indian Tribe, the Shinnecock Indian Nation, and the Lenape Tribe of Delaware are required, Atlantic Shores also engages with other federal- and state-recognized tribes, including the Absentee Shawnee Tribe, the Delaware Nation, the Delaware Tribe of Indians, the Mohican Nation Stockbridge–Munsee Band, the Shawnee Tribe, the Nanticoke Lenni-Lenape Tribal Nation, the Ramapough Lenape Nation, the Powhatan Renape Nation, and the Unkechaug Indian Nation. Atlantic Shores uses multiple means of communication (i.e., email, telephone, contacts in other tribes) to engage each tribe and has reached out to BOEM's and NJDEP's tribal liaisons to obtain the most current lists of tribal points of contact. Meetings conducted with tribal representatives to date are listed in Appendix I-B.

In addition to fulfilling regulatory requirements to notify tribes prior to specific milestones, Atlantic Shores has worked to establish early relationships to address tribal concerns. Atlantic Shores' approach to tribal engagement first focused on understanding the histories of the tribes, learning about their traditions, and providing opportunities for tribes to provide input into the Projects. In responding to tribes' request to learn about the Project's activities, Atlantic Shores provided tribal members with a virtual platform to participate in the real-time assessment of deep-sea borings from the Project Area by Qualified Marine Archaeologists.

As the Projects advance, Atlantic Shores will continue to consult with federal, state, and local agencies and municipalities as well as federal and state-recognized tribes.

#### 1.4.2 Stakeholder Outreach

Atlantic Shores is actively engaged with stakeholders to identify and discuss their interests and concerns regarding offshore wind and the development of the Projects. Since early 2019, Atlantic Shores has conducted hundreds of meetings and working sessions with stakeholders, suppliers, interest groups, and local communities that have an interest in or may be affected by the Projects (see Appendix I-B). The community groups and stakeholders that Atlantic Shores is engaged with include:

- **Atlantic County, Ocean County, and Monmouth County residents:** Residents of these counties may live near the Projects' landfall sites, onshore interconnection cable routes, onshore substations, and/or O&M facility. Some residents may have a view of the WTGs.



- **Business groups/associations:** Atlantic Shores has strategically identified business groups and associations that it can join in diverse partnerships. The goals of these partnerships include information sharing, workforce training, and supply chain contacts. As described in Section 2.1, Atlantic Shores is also working to create local employment through collaboration with existing local supply chain partners and by attracting new suppliers to the Northeastern U.S. As part of this effort, Atlantic Shores has signed a first-of-its-kind memorandum of understanding (MOU) with six local unions to help train and employ a productive, safe, skilled, local offshore wind workforce.
- **Environmental non-governmental organizations (eNGOs):** Atlantic Shores has conducted environmental resource and issue-focused meetings with representatives from local, regional, and national eNGOs (e.g., New Jersey Sierra Club, New Jersey Energy Coalition, Clean Water Action, New Jersey Audubon, Surf Rider, National Wildlife Federation, Barnegat Bay Partnership, Conservation Law Foundation, the Natural Resources Defense Council, etc.) to educate them about the Projects and to identify shared objectives, opportunities for collaboration, and topics requiring further discussion. Appendix I-B provides a complete list of meetings between Atlantic Shores and eNGOs.
- **Academia and research/scientific institutes:** Atlantic Shores is coordinating with educational and technical institutions (e.g., Rutgers University, Rowan College, Stockton University) to support cooperative science, engineering, research, and next generation workforce training that may benefit the Projects' development, construction, and operations (see Appendix I-B). These activities also contribute to broader regional research efforts (see Section 2.2). Atlantic Shores has asked more than 52 different institutions to declare their interest in collaboration on academic and educational work in relation to the Projects, of which approximately eight have expressed an interest in doing so to date.
- **Commercial and recreational fishermen and boaters:** Atlantic Shores engages with commercial and recreational boaters and fishermen that are active in and around the Atlantic Shores' Offshore Project Area. To date, Atlantic Shores has held meetings with commercial and recreational fishermen from Belford, Point Pleasant, Barnegat Light, Atlantic City, Cape May, and other ports like Ocean City and Sea Isle City. Atlantic Shores' engagement with fishermen is described further in Section 1.4.2.1.

To engage in productive and effective dialogue with key stakeholders, Atlantic Shores has assembled a Stakeholder Communications Team comprised of Atlantic Shores management, Community Liaison Officers, community relations staff, and government relations staff. All have prior experience working cooperatively within New Jersey coastal communities, allowing Atlantic Shores to better understand the interests and concerns of stakeholder groups.

Atlantic Shores has developed and implemented a wide array of stakeholder engagement tools to establish two-way dialogue with interested parties and to educate people and organizations about Atlantic Shores and more broadly offshore wind. Atlantic Shores engages stakeholders by:

- attending community events and hosting in-person community meetings;
- maintaining an up-to-date and interactive website;

- distributing quarterly newsletters containing Project updates to over 1,000 stakeholders;
- using social media platforms (e.g., Facebook and Twitter) for educational videos, Projects updates, promoting opportunities;
- hosting informational sessions and open houses (in-person and/or virtually);
- participating in and organizing workshops with key local, regional, and national eNGOs; and
- conducting polling and focus groups.

These tools also provide opportunities for people and organizations to express interest in partnering with Atlantic Shores on workforce, supply chain, port development, or other related activities.

Atlantic Shores' stakeholder engagement strategy creates effective mechanisms for capturing, documenting, and responding to stakeholder feedback to ensure that the outcomes of each interaction can be incorporated into Project development efforts.

#### 1.4.2.1 Fisheries Engagement

Atlantic Shores understands the socioeconomic importance of commercial and recreational fishing to the State of New Jersey and is committed to achieving coexistence with those who fish within the Offshore Project Area. Atlantic Shores has developed a Fisheries Communication Plan (FCP), provided as Appendix II-R, that defines outreach and engagement with fishing interests during all phases of the Projects, from development through decommissioning. To support the execution of the FCP, Atlantic Shores employs a Fisheries Liaison Officer (FLO) and a Recreational Fishing Industry Representative (FIR). An active commercial fisherman, Captain Kevin Wark, is employed as the FLO. Captain Adam Nowalsky is the Recreational FIR. Additional FIRs may be nominated to represent specific fisheries identified within the Lease Area or along the ECCs as the Projects progress or a need is identified.

To facilitate open engagement with the fishing community that is active in and around the Offshore Project Area, Atlantic Shores maintains a "For Mariners" webpage, distributes updates on Atlantic Shores' activities (via an email distribution list, print and online industry publications, local news outlets, etc.), coordinates with the USCG to issue Notices to Mariners, plans to establish a 24-hour phone line, and attends fishing conferences, trade shows, and tournaments. Atlantic Shores will continue to hold and attend meetings with local fishermen, professional associations/organizations representing commercial and recreational fishermen, and local offshore fishing clubs during the lifetime of the Projects. Atlantic Shores will also continue to participate in Fisheries Management Council meetings, university-sponsored activities (e.g., webinars held by Rutgers New Jersey Cooperative Extension), and regional efforts led by BOEM, National Oceanic and Atmospheric Administration (NOAA), and the commercial fishing industry (including the Responsible Offshore Development Alliance [RODA] and the Responsible Offshore Science Alliance [ROSA]).

Additionally, Atlantic Shores is committed to finding ways to integrate both the skills and infrastructure of the local fishing community into the Projects by planning, brainstorming, and executing early economic opportunities. Atlantic Shores is already employing local fishermen and their facilities for scouting and dock-side vessel support. Building on this model, Atlantic Shores is actively pursuing avenues to help fishermen meet Atlantic Shores' HSSE standards for vessels and workforce, so that they can be eligible to apply as contractors to support environmental surveys as well as the Projects' construction and operations activities. In September 2020, Atlantic Shores distributed a formal Request for Interest to identify fishing businesses that had available docks and port real estate that could support Atlantic Shores' construction and operations; Atlantic Shores received strong responses from four local fishing companies, indicating that the fishing industry does find valuable economic opportunities in the offshore wind industry.

Section 7.3 Recreation and Tourism and Section 7.4 Commercial and For-Hire Recreational Fisheries of Volume II as well as the Navigation Safety Risk Assessment (NSRA) provided as Appendix II-S further describe Atlantic Shores' methods to communicate and engage with fisheries.

## 1.5 Other Project Information

### 1.5.1 Authorized Representative and Operator

The Project operator for Project 1 is Atlantic Shores Project 1 Company. The Project operator for Project 2 is Atlantic Shores Project 2 Company. The Projects' Authorized Representative is Atlantic Shores' Vice President and Development Director, Jennifer Daniels. Her contact information is provided below:

Jennifer Daniels  
Vice President and Development Director  
Atlantic Shores Offshore Wind, LLC  
1 Dock 72 Way, Floor 7  
Brooklyn, NY 11205  
858-946-3235  
[jennifer.daniels@atlanticshoreswind.com](mailto:jennifer.daniels@atlanticshoreswind.com)

### 1.5.2 Certified Verification Agent

Pursuant to 30 CFR §§ 585.705-585.714 a third-party Certified Verification Agent (CVA) will be employed by Atlantic Shores to conduct an independent assessment of the design of the Projects' facilities as well as the planned fabrication and installation activities. The CVA will certify to BOEM that the Projects are designed to withstand the site-specific environmental and functional load conditions appropriate for its intended service life. The CVA will also monitor fabrication and installation activities through periodic on-site inspections and certify to BOEM that the Projects are fabricated and installed in accordance with accepted engineering practices, the COP, and each

Projects' Facility Design Report (FDR) and Fabrication and Installation Report (FIR). Atlantic Shores will nominate a CVA(s) for the Projects' FDRs and FIRs in conformance with 30 CFR §585.706(a) and subject to BOEM approval.

### 1.5.3 Health, Safety, Security, and Environmental Protection

Health, safety, security, and environmental (HSSE) protection are critical components of all Atlantic Shores' planning and activities. The health and safety of Atlantic Shores' team members, contractors, and stakeholders is a key priority; Atlantic Shores upholds safety as a core value and fosters a culture of "Goal Zero" that focuses on eliminating safety related incidents. Atlantic Shores also prioritizes the responsible integration of the Projects into the New Jersey coastal and marine environment.

Atlantic Shores is committed to full compliance with applicable HSSE regulations and codes throughout the pre-construction, construction, O&M, and decommissioning phases of the Projects. The following sections highlight the systems and plans that will be implemented, in accordance with BOEM and other applicable regulations, to ensure HSSE protection throughout the Projects' lifecycle. These plans include the Projects' Safety Management System (SMS), Oil Spill Response Plan (OSRP), and Spill Prevention, Control, and Countermeasure (SPCC) Plan. Volume I of this COP includes a draft OSRP and SMS (Appendices I-C and I-D). These draft plans are representative of the requirements, procedures, and best practices that will be implemented in support of both Projects. Individual plans for Project 1 and Project 2 will be developed for BOEM review and acceptance prior to construction with each Project's FDR and/or FIR. Public safety, public access, and low probability events such as spills are discussed further in Section 9.0 Public Health and Safety of Volume II.

#### 1.5.3.1 Safety Management System

Atlantic Shores has assembled a draft SMS, which is provided as Appendix I-E. The SMS contains Atlantic Shores' overall safety approach and management commitment as well as safety-related policies and procedures that will guide all work on the Projects. The SMS draws upon the extensive experience of Atlantic Shores' team members and its parent companies (EDF Renewables and Shell New Energies US LLC) with executing work on large infrastructure and energy projects, both onshore and offshore, and will incorporate lessons learned as the Projects progress. All Project activities will be conducted in accordance with a project-specific SMS to ensure avoidance or minimization of potential safety-related impacts to anyone on or near the Project's facilities.

The draft SMS provided as Appendix I-E-1 meets BOEM's requirements contained in 30 CFR §585.810 by including a description of:

- how Atlantic Shores will ensure the safety of personnel or anyone on or near the Projects' facilities;
- remote monitoring, control, and shutdown capabilities;

- site-specific emergency response procedures;
- fire suppression equipment;
- procedures for testing the SMS; and
- methods for ensuring Project personnel are properly trained.

The SMS also contains company-specific HSSE policies beyond those prescribed in 30 CFR §585.810, including:

- other applicable HSSE regulations (e.g., Occupational Safety and Health Administration [OSHA] regulations);
- hazard identification and risk management procedures;
- communication protocols;
- qualifications and authority to perform work; and
- safe work procedures to ensure safe access to all systems (e.g., Permit to Work, Lockout/Tagout).

A final SMS specific to Project 1 and 2 will be submitted for BOEM review and acceptance prior to construction with each Project's FDR and/or FIR.

### 1.5.3.2 Spill Response Plans

Before construction and installation, project-specific OSRPs will be developed and issued to all vessels and offshore contractors working on the Projects. In accordance with 30 CFR §585.627(c) and 30 CFR Part 254, each project-specific OSRP will define spill prevention measures as well as provisions for communication, coordination, containment, removal, and mitigation in the event of an unforeseen incident involving an offshore spill. The OSRPs will also describe training, equipment testing, and periodic drills to prepare for a spill response. A draft OSRP that is representative of the requirements, procedures, and best practices that will be implemented in support of Project 1 and 2 has been provided as Appendix I-D. A final project-specific OSRP will be submitted for BOEM review and acceptance prior to construction with each Project's FDR and/or FIR.

In addition to the OSRP, contractors will be required to have plans to immediately contain and stop a spill in accordance with applicable regulations (see Section 7.0). All contractor plans will be reviewed to ensure they comply with the applicable regulations, the requirements of Atlantic Shores and are consistent with each Project's OSRP procedures. Routine training and audits on the content of each Project's OSRP will be conducted on a regular basis to ensure personnel are familiar with plan requirements and are prepared to respond to emergencies, should they occur.

Since the onshore facilities will have more than 1,320 gallons (4,997 liters) of oil in aboveground equipment (see Table 7.0-3 in Section 7.0), project-specific SPCC Plans will also be developed and maintained per 40 CFR Part 112. The project-specific SPCC Plans will identify what oil materials

are stored at the onshore facilities, how oil is delivered and transferred, facility spill prevention and control procedures, spill response and notification procedures, inspections, recordkeeping, and reporting requirements. For Project 1 and 2, a Discharge Prevention, Containment, and Countermeasure (DPCC) Plan and a Discharge Cleanup and Removal (DCR) Plan per N.J.A.C. 7:1E will be submitted to the NJDEP. In addition, horizontal directional drilling (HDD) Inadvertent Release Plans for construction activities at the landfall sites will be developed for the Projects.

## 2.0 Benefits of the Projects

The Projects will provide clean, renewable energy to the Northeastern U.S., which will help the region achieve its renewable energy goals, diversify the region's electricity supply, and increase electricity reliability. The Project will be a meaningful contributor to the region's economy by creating thousands of well-paid jobs in the burgeoning renewable energy sector.

The importance of the renewable energy sector in revitalizing the U.S.' economy is exemplified in Presidential Executive Order 14008 (Tackling the Climate Crisis at Home and Abroad), which describes clean energy jobs as a central pillar of the President's Build Back Better and economic recovery plan and directs the Secretary of the Interior to review siting and permitting processes to identify steps to double offshore wind energy production by 2030 (see Section 207; White House 2021). As described in the Executive Order, the construction, manufacturing, engineering, and skilled-trades jobs needed to build a clean energy economy will bring opportunity to communities "that have suffered as a result of economic shifts and places that have suffered the most from persistent pollution, including low-income rural and urban communities, communities of color, and Native communities."

A significant portion of the Projects' economic and community benefits will be realized in New Jersey. As identified in the New Jersey Offshore Wind Strategic Plan, the development of offshore wind energy, such as the Atlantic Shores' Projects, is critical to addressing climate change and to building the State's clean energy economy (Ramboll 2020). As described by New Jersey Governor Phil Murphy, "Developing New Jersey's offshore wind industry will bring thousands of good-paying jobs and millions of dollars in economic development to our state to aid our economic recovery from COVID-19" (NJBPU 2020).

The Projects' economic, community, environmental, and public health benefits are detailed in the following sections.

### 2.1 Economic and Community Benefits

The Projects will provide several benefits to the Northeast's economy and communities (particularly within New Jersey) including:

- **Direct job creation:** The Projects are expected to directly create more than 22,290 full time equivalent (FTE)<sup>11</sup> jobs throughout their lifecycle. During the development and construction period, direct jobs will primarily be in construction, manufacturing, professional services (e.g., engineering and general management), transport, and warehousing. During operations and maintenance (O&M) and decommissioning, direct jobs will include jobs in operations and maintenance (e.g., wind turbine generator [WTG] technicians) as well as professional services.

---

<sup>11</sup> Based on a 40-hour work week.

- Indirect and induced job creation:** Atlantic Shores estimates that the Projects will create more than 11,810 indirect FTE jobs and over 14,820 induced FTE jobs, for a total of more than 48,920 direct, indirect, and induced FTE jobs. Atlantic Shores intends to procure local suppliers and use local manufacturing facilities to the maximum extent practicable. Atlantic Shores anticipates that hiring local suppliers and manufacturing facilities will provide continued support of existing jobs and potentially create thousands of additional jobs in New Jersey and, more broadly, the Northeastern U.S. Indirect jobs created by the Projects will primarily be in management services, wholesale trade, and transportation, but may also include real estate, finance, insurance, and several other regional industries that will benefit from increased economic activities. The Projects may also support other sectors, such as health care and social assistance, retail trade, and accommodation and food services.
- Use of local supply chains:** Atlantic Shores has prioritized using local suppliers for a significant amount of development activities, including for survey activities, technical analysis, environmental and economic analysis, and legal services. As the development of the Projects progresses, Atlantic Shores will continue to expand its list of local suppliers. Atlantic Shores has proposals from major suppliers for local manufacturing that would bring hundreds of jobs to New Jersey and, more broadly, the Northeastern U.S. Atlantic Shores is also seeking ways to maximize the use of organized union labor and employers wherever feasible. To demonstrate that commitment, Atlantic Shores has signed a first-of-its kind memorandum of understanding (MOU) with six local unions (UBCJA [Carpenters, Divers, Dock builders and Piledrivers], LIUNA [Laborers], IBEW [Electricians], IUOE [Operating Engineers], Ironworkers, and Union Millwrights) to help train and employ a productive, safe, skilled, local workforce.
- Revenues, taxes, and fees:** The Projects will increase revenues collected by federal, state, and local governments via personal income taxes, payroll taxes, sales taxes, property taxes, corporate taxes, and other fees (e.g., permit application fees) paid by Atlantic Shores, its contractors, and their employees. Economic activity resulting from the Projects will generate additional revenue throughout the Northeast. Atlantic Shores and its affiliate Project Companies will also make substantial annual rent payments and operating fee payments to the federal government in accordance with its Lease Agreement.
- Establishment of an O&M facility in the Atlantic City Harbor:** Atlantic Shores is proposing to establish a new O&M facility in Atlantic City to host its O&M personnel, dock vessels, and store equipment, tools, spare parts, and consumables (see Section 5.5). The O&M facility will host long-term jobs in technical services, project planning, data analysis, WTG preventative maintenance and repair, cable and foundation monitoring, and substation maintenance. The O&M facility will also create economic activity for a wide range of subcontractors including shipyards, spare part producers, and vessel and harbor services.



- **Facilitation of future offshore wind and other green developments:** The Projects are anticipated to contribute to the establishment of facilities and development of ports that would be instrumental in attracting and supplying future U.S. offshore wind developments, and positioning talent, expertise, and research and development (R&D) activities within the Northeastern U.S.
- **Workforce development and training:** Atlantic Shores will support workforce initiatives, which will be developed in connection with its proposals submitted in response to offshore wind solicitations. These initiatives will have a strong focus on providing support to minorities, women, veterans, and underserved communities. Workforce development initiatives contained in Atlantic Shores' proposal in response to the New Jersey Offshore Wind Solicitation #2 include initiatives with Rutgers University, Rowan College, the Barnegat Bay Partnership, and the Boys & Girls Club of Atlantic City, as well as workforce training with several manufacturers and suppliers. Additional or alternative initiatives may be developed as part of other procurement processes.
- **Educational and Community Outreach (ECO) Center:** In 2020, Atlantic Shores opened its new ECO Center in partnership with Stockton University in Atlantic City, New Jersey. The ECO Center will serve as an educational hub; the Center will be the primary location for community informational events, including educational visits from local school groups, and act as a resource center for university students. The ECO Center constitutes a major local investment.
- **Fostering innovation, research, and university outreach:** As part of its project development efforts, Atlantic Shores has established robust working relationships with several research organizations and universities, such as Rutgers University and Stockton University, to foster innovative and environmentally responsible approaches to offshore wind development (see Section 1.4.2). Through its participation in the New Jersey Offshore Wind Solicitation #2, Atlantic Shores has committed to numerous initiatives to support research and innovation, including supporting a green hydrogen pilot project and funding clean energy start-ups within the Minority & Women Owned Business Incubator at the Rutgers EcoComplex located in Bordentown, New Jersey. Additional or alternative programs may be developed as part of other procurement processes.
- **Support for women, minorities, and veterans:** Atlantic Shores has developed MOUs with organizations (e.g., Boys & Girls Club of Atlantic City, Helments2Hardhats) to provide opportunities for employment, education, and training to women, minorities, and veterans as the WTA is developed. Atlantic Shores will continue pursuing contracts with women- and minority-owned New Jersey businesses. To build awareness of opportunities in offshore wind, Atlantic Shores is a member of several chambers of commerce supporting minority groups, including the African American Chamber of Commerce, the Statewide Hispanic Chamber of Commerce, and the Chapter of Professional Women in Construction.

- **Tourism and reactional opportunities:** The Projects' offshore facilities may act as artificial reef habitat that attract fish (BOEM 2012) and become popular fishing locations for fishermen. The Projects' offshore facilities may also become tourist attractions (Carr-Harris and Lang 2019; Parsons et al. 2020). See Section 7.3 Recreation and Tourism and Section 7.4 Commercial and For-Hire Recreational Fisheries of Volume II for additional details.

## 2.2 Environmental and Public Health Benefits

Atlantic Shores is working to maximize the environmental benefits and minimize the environmental impacts of the Projects. The recurring and accumulating benefits created by each Project over its operational life represent significant cumulative increases in environmental quality compared to the localized, temporary construction effects that can be mitigated. Overall, Atlantic Shores expects that the Projects' anticipated benefits will significantly outweigh the potential impacts.

The environmental and public health benefits provided by the Projects include:

- **Reductions in greenhouse gas (GHG) and criteria air pollutant emissions:** The Projects will result in a significant net decrease in harmful air pollutant emissions region-wide by displacing electricity from fossil fuel power plants. For every megawatt of power generated, the Projects are expected to reduce GHG emissions, reported as carbon dioxide equivalents (CO<sub>2</sub>e), by approximately 2,625 tons per year (tpy).<sup>12</sup> For Project 1, which has a nameplate capacity of 1,510 megawatts (MW),<sup>13</sup> the reduction in GHG emissions regionally is estimated to be approximately 3.9 million tons annually, or the equivalent of removing about 777,000 cars from the road. Per megawatt, the Projects are expected to reduce nitrogen oxide (NO<sub>x</sub>) emissions by 1.43 tpy, sulfur dioxide (SO<sub>2</sub>) emissions by 1.69 tpy, and fine particulate matter (PM<sub>2.5</sub>) emissions by 0.10 tpy. The Projects will also reduce regional emissions of other pollutants typically emitted by fossil fuel power plants such as mercury, carbon monoxide, methane, and nitrous oxide. The Projects' avoided air emission estimates are further discussed in Section 3.1 Air Quality of Volume II.
- **Air quality benefits and avoided public health costs:** By reducing regional emissions, the Projects are expected to improve air quality thereby reducing the harmful effects of air pollutants such as NO<sub>x</sub>, SO<sub>2</sub>, and PM<sub>2.5</sub>, which are linked to increased rates of early death, stroke, heart attacks, exacerbation of asthma, and respiratory disorders as well as increased

---

<sup>12</sup> Avoided air emissions estimates are based on the latest-available non-baseload output emission rates for the Reliability First Corporation (RFC) East subregion as published by the Environmental Protection Agency (EPA 2020), assuming a 50% capacity factor and 4% transmission losses for the Projects.

<sup>13</sup> An ~1,500 megawatt (MW) project is a reasonable representation of a mid-sized project that could be developed within the WTA.

absenteeism at school and work. The Projects will also reduce emissions that contribute to acid rain, ocean acidification, and ground level ozone/smog, which can damage sensitive ecosystems and other resources.

- **Climate benefits:** Climate change, which is strongly associated with GHG emissions from fossil-fuel combustion and industrial practices, has been identified as possibly the greatest public health threat of the 21st century (WHO 2021). The impacts of climate change on the environment and human health include sea level rise and population displacement, property damage from floods, shifts in species' distributions worldwide, changes in agricultural productivity, increases in energy system costs (e.g., air conditioning costs), and impacts to water security, food security, and nutrition. By reducing reliance on fossil fuel-derived electricity that generates GHGs, the Projects can help to mitigate additional climate change damages that impact both public health and the environment.
- **Environmental research and monitoring programs:** As described in Section 4.1.2, environmental monitoring surveys will be conducted to support the assessment of the Projects' potential effects and, more broadly, to inform agency, stakeholder, and public understanding of the potential benefits and impacts of offshore wind project development. Atlantic Shores' will conduct fisheries studies (see Appendix II-K) and benthic habitat monitoring (see Appendix II-H). Additional environmental studies and monitoring programs supported by Atlantic Shores to date include:
  - **Study on red knot migratory patterns:** Atlantic Shores has partnered with Dr. Larry Niles of the New Jersey-based Wildlife Restoration Partnerships, the New Jersey Audubon Society, the U.S. Fish and Wildlife Service (USFWS), and professional wildlife research organizations Normandeau Associates and Biodiversity Research Institute to research the movement of threatened red knots off the coast of New Jersey during their southbound and northbound migration.
  - **Climate, storm, and wildlife research:** Atlantic Shores has collaborated with the Rutgers University Center for Ocean Observing Leadership (RUCOOL) and the Rutgers University Marine Field Station to install a wind light detection and ranging (lidar) instrument in Tuckerton, New Jersey. The lidar will be in place for the next several years to collect real-time weather observations. This information will contribute to Rutgers' research on sea breezes and coastal storms, as well as future research initiatives conducted by RUCOOL and Atlantic Shores.

Atlantic Shores also expects to participate in regional monitoring initiatives and coordinate with research organizations and universities to develop additional environmental study programs. Atlantic Shores provides funding and scientific expertise sharing to the Responsible Offshore Science Alliance (ROSA), where Atlantic Shores serves on the Board and Advisory Committee. Atlantic Shores and its parent companies are also early adopters and funders of the Regional Wildlife Science Entity, the parallel organization to ROSA that covers regional bird, mammal, and sea turtle science.

- **Addition of hard substrate and structures offshore:** The Projects are expected to produce ecological benefits by providing new, diverse habitat for structure-oriented species (e.g., black sea bass, tautog, cunner). The offshore facilities (i.e., foundations, scour protection, and cable protection) will create new, hard substrate that provide shelter and feeding opportunities as well as spawning and nursery grounds in an area that is largely comprised of flat, sandy habitat (ICF 2020). For example, Leonhard et al. (2011) studied fish assemblages one year before and eight years after the construction of the Horns Rev Wind Farm in the North Sea and observed an increase in species diversity close to WTGs, specifically in reef fishes (Leonhard et al. 2011). See Sections 4.5.2.5 and 4.6.2.6 of Volume II for further discussion of the Projects' ecological benefits to benthic and shellfish resources as well as finfish and invertebrates.

### 3.0 Evolution of the Project Design Envelope

Atlantic Shores is requesting review and authorization of the Projects using a Project Design Envelope (PDE) approach as outlined in the Bureau of Ocean Energy Management's (BOEM's) (2018) draft PDE guidance. The Projects' PDE is summarized in Section 1.1 and more completely described in Section 4.0. This section summarizes Atlantic Shores' siting process and explains how the PDE was developed.

The Projects' PDE includes a reasonable range of designs for proposed components (e.g., foundations, wind turbine generator (WTGs), export cables, onshore elements) and installation techniques (e.g., use of anchored, jack-up, or dynamic positioning [DP] vessels). Identifying a range of design parameters and installation methods allows BOEM to analyze the maximum impacts that could occur from the Projects while providing Atlantic Shores with the flexibility to optimize the Projects within the approved PDE during later stages of the development process. The PDE will enable Atlantic Shores to employ the best available technology, which often outpaces the permitting process, to maximize renewable energy production, minimize adverse environmental effects, address stakeholder concerns, and minimize cost to ratepayers. In developing the PDE, Atlantic Shores focused on ensuring that all components and systems included in the PDE:

- provide safety of structures, equipment, personnel, the public, and the environment;
- comply with all federal, state, and local regulations, permit requirements, and Lease Agreement stipulations;
- have sufficient strength to withstand operational and environmental loads, extreme events (including hurricanes), and accidental events;
- have adequate durability against environmental conditions over the asset's life;
- optimize energy yield of the Lease Area;
- maintain high reliability;
- enable ease of offshore handling, transport, installation, testing, commissioning, operations, maintenance, repairs, decommissioning, and dismantling;
- consider all phases of fabrication, transport, installation, operations, and decommissioning;
- optimize the use of resources and technology to reduce initial and lifetime costs;
- allow the use of local services, suppliers, and labor to the maximum extent possible; and
- avoid or minimize impacts to the public and the environment.

This section describes how key Project attributes were developed in accordance with these principles, including the Projects' layout, onshore and offshore routing, foundation types, and WTG dimensions.

## 3.1 Development of the WTA Layout

The Wind Turbine Area (WTA) is located in the southern portion of Lease Area OCS-A 0499. Atlantic Shores considered the following criteria to develop the layout of the Projects' WTGs and offshore substations (OSSs) in the WTA:

- **Technical considerations:** Wind resources at the WTA and the power production potential of different layouts were assessed.
- **Existing uses and sensitive areas:** Existing vessel traffic patterns and feedback from agencies and stakeholders (including the U.S. Coast Guard [USCG] and commercial and recreational fishermen) were considered. Layout orientations that minimize impacts to existing marine uses are preferred. Layouts that minimize visual impacts by locating OSSs farther from shore are also preferred.

Based on these criteria, with a specific focus on minimizing effects to existing marine uses, the WTGs for both Projects will be aligned in a uniform grid with multiple lines of orientation allowing straight transit through the WTA. The primary east-northeast to west-southwest transit corridors were selected to align with the predominant flow of vessel traffic; accordingly, WTGs will be placed along east-northeast to west-southwest rows spaced 1.0 nautical mile (nm) (1.9 kilometers [km]) apart to allow for two-way vessel movement (see Figure 3.1-1). The proposed grid also facilitates north to south transit by positioning WTGs along rows in an approximately north to south direction<sup>14</sup> spaced 0.6 nm (1.1 km) apart. The WTG grid will also create diagonal corridors of 0.54 nm (1.0 km) running approximately northwest to southeast as well as diagonal corridors of 0.49 nm (0.9 km) running approximately north-northeast to south-southwest (see Figure 3.1-1).

The OSSs for the Projects will be placed to preserve all of the primary transit corridors and the majority of the secondary corridors. Specifically, the OSS positions for the Projects will also be located along the same east-northeast to west-southwest rows as the WTGs, preserving all of the primary east-northeast transit corridors. The OSSs may be placed between WTGs in the north to south direction (see Figure 3.1-2); however, Atlantic Shores will only position the OSSs in up to three north to south rows to preserve most of the north to south transit corridors. Figure 3.1-2 illustrates how Atlantic Shores has identified up to three areas within the WTA where OSSs may be located; within each of these three areas, any OSSs will be placed within a single north to south row. The three areas where OSSs may be placed include a setback from the shoreline to minimize visual impacts: small OSSs will be placed no closer than 12 miles (mi) (19.3 km) from shore and medium or large OSSs will be placed no closer than 13.5 mi (21.7 km) from shore (OSS sizes are described in Section 4.4).

---

<sup>14</sup> The north to south rows are oriented at 357 degrees true north.

8/20/2021 | G:\Projects\21\MS6512021\Task\_1\Map\Fig 3.1-1\_Project\_Layout\_20210819.mxd

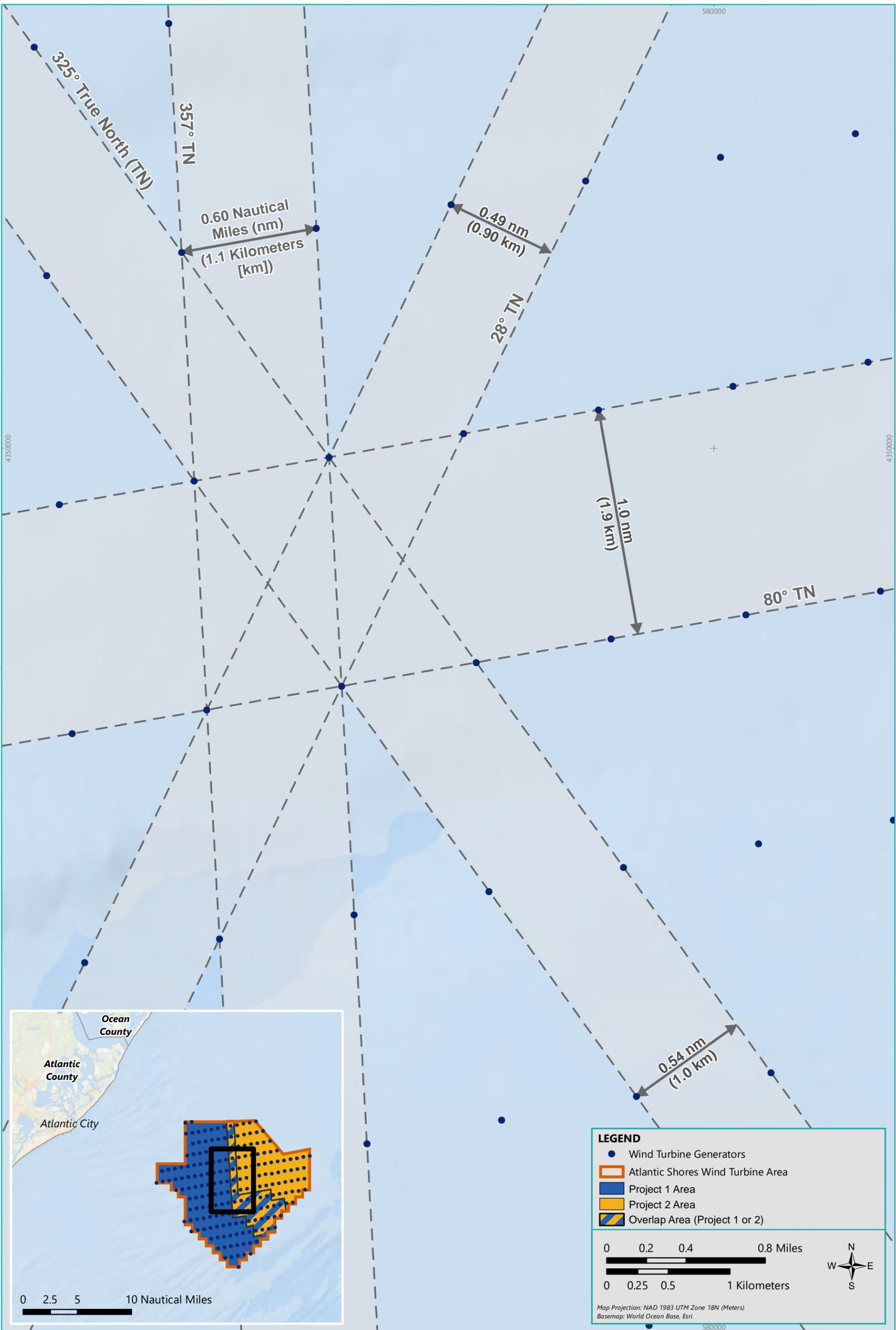

**Figure 3.1-1**  
WTA Layout

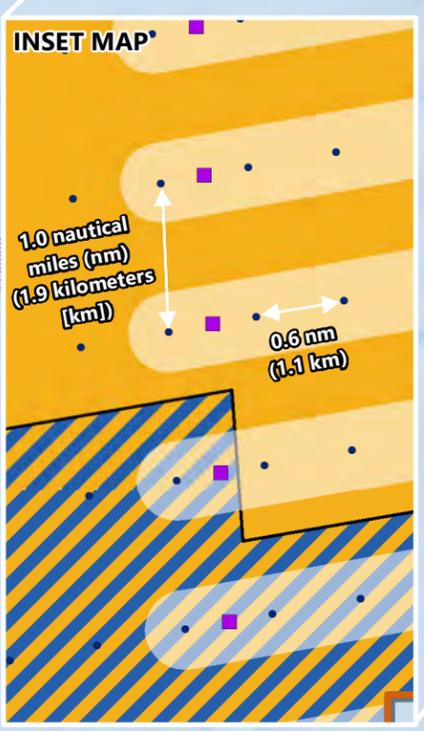
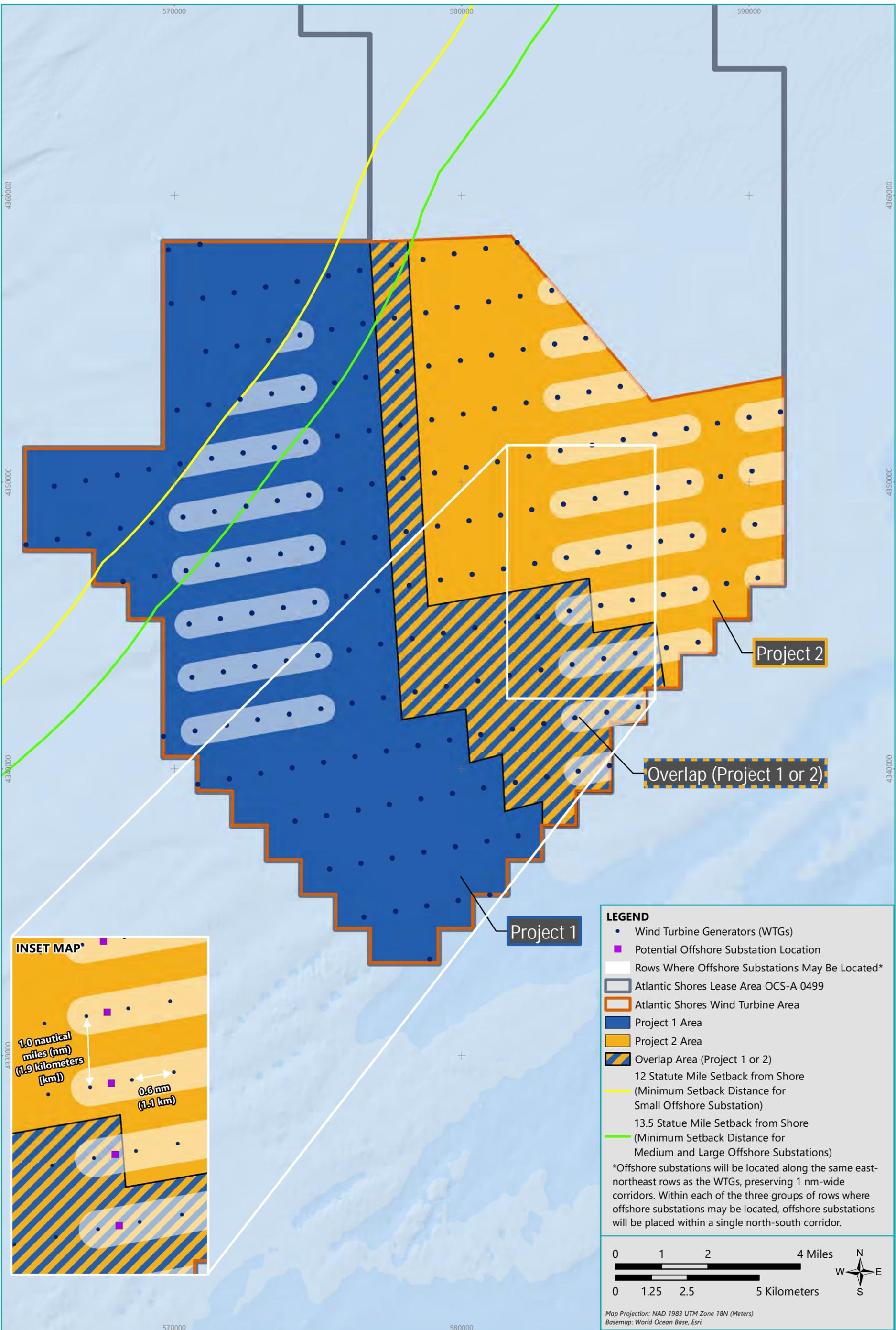

**LEGEND**

- Wind Turbine Generators (WTGs)
- Potential Offshore Substation Location
- ▭ Rows Where Offshore Substations May Be Located\*
- ▭ Atlantic Shores Lease Area OCS-A 0499
- ▭ Atlantic Shores Wind Turbine Area
- Project 1 Area
- Project 2 Area
- ▨ Overlap Area (Project 1 or 2)
- ▭ 12 Statute Mile Setback from Shore
- ▭ (Minimum Setback Distance for Small Offshore Substation)
- ▭ 13.5 Statute Mile Setback from Shore
- ▭ (Minimum Setback Distance for Medium and Large Offshore Substations)

\*Offshore substations will be located along the same east-northeast rows as the WTGs, preserving 1 nm-wide corridors. Within each of the three groups of rows where offshore substations may be located, offshore substations will be placed within a single north-south corridor.

0 1 2 4 Miles

0 1.25 2.5 5 Kilometers

Map Projection: NAD 1983 UTM Zone 18N (Meters)  
 Basemap: World Ocean Base, Esri

**Figure 3.1-2**  
 Offshore Substation Locations



The WTA layout was specifically configured to consider commercial fishing patterns, particularly for the surf clam/quahog dredging fleet, which is the predominant commercial fishery within the WTA (see Section 7.4 Commercial Fisheries and For-Hire Recreational Fishing of Volume II). While the primary direction of fishing vessel traffic varies somewhat across the Lease Area (a northeast to southwest heading is more frequent in the northern portion of the Lease Area whereas a southeast to northwest heading is more common farther south), commercial fishermen and USCG have indicated a preference for a uniform layout across the entire Lease Area to facilitate navigation. A standard and uniform grid pattern is also preferred by USCG to facilitate search and rescue (SAR) missions in the WTA. Thus, the layout of the WTA will be consistent with the layout of the entire Lease Area.

An independent study was conducted by Last Tow LLC on behalf of representatives of the New Jersey surf clam industry to provide Oceanside Marine (a clam fishing fleet based in Atlantic City) and LaMonica Fine Foods (a seafood processor in Millville, New Jersey) with a better understanding of fishing vessel traffic characteristics within the Lease Area (Azavea 2020). Based on 2008-2019 Vessel Monitoring System (VMS) data for several surf clam/quahog fishing vessels that operate in the Lease Area, the study found that a significant majority of fishing vessel traffic (towing and transiting) had headings between east to west and east-northeast to west-southwest (with an average heading of 80 degrees from true north). This finding was supported by the analysis of three years (2017-2019) of Automatic Identification System (AIS) data included in the Projects' Navigation Safety Risk Assessment (NSRA) (see Table C.11 in Appendix II-S), which showed that 46% of fishing vessels transit the Lease Area along tracks that range in orientation between east to west and northeast to southwest. The remaining fishing vessel traffic (approximately 34%) and a significant proportion of the recreational vessel traffic transit north to south; this traffic will be accommodated by the approximately north to south corridors.

Atlantic Shores anticipates that larger commercial vessels (e.g., cargo, tanker, passenger, and tug-barge vessels), which have dominant north to south transit headings, will route around the WTA and not through it. The additional time required to travel around versus through the WTA was estimated to be on the order of 15 to 20 minutes. This re-routing of commercial traffic is clearly recognized in the recent Atlantic Ocean Port Access Routing Study (ACPARS) performed by the USCG in 2016, which has led into an Advanced Notice of Proposed Rulemaking (USCG 2020b) with the identification of a deep draft fairway to the east of the WTA, termed the St. Lucie to New York Fairway, and a proposed Tow Tug Extension Lane to the west of the WTA. However, the WTA will not be closed to commercial vessel traffic. Should commercial vessels choose to transit the WTA, based on USCG recommended guidelines for corridor spacing (USCG 2020a), the 0.6-nm-wide (1.1-km-wide) approximately north to south transit corridors are expected to facilitate

commercial vessel traffic for vessels up to 87 to 144 feet (ft) (27 to 44 meters [m]) in length.<sup>15</sup> See the NSRA provided as Appendix II-S for further discussion of the layout's potential effects on maritime navigation and USCG SAR activities.

Atlantic Shores evaluated and eliminated the possibility of using the same layout proposed by the Ocean Wind Project in Lease Area OCS-A 0498, which abuts the WTA to the southwest, based on recommendations of the USCG and commercial fishing industry. As shown on Figure 3.1-3, the predominant direction of vessel traffic varies considerably between Lease Area OCS-A 0499 and Lease Area OCS-A 0498. Atlantic Shores presented the option of a layout that is consistent with Ocean Wind to the USCG on March 31, 2020, and the USCG recommended that Atlantic Shores align its layout with the predominant direction of vessel traffic within its Lease Area rather than align with Ocean Wind. Atlantic Shores also met with commercial fishermen on April 16, 2020, to discuss the potential layout. Representatives from the surf clam industry (which is the highest revenue fishery within the WTA) provided feedback that a proposed layout with east-northeast rows was best for their transiting and towing activities.

## 3.2 Onshore Facility Siting

While both Project 1 and Project 2 will be electrically distinct from one another, the Projects require the ability to interconnect at two POIs to accommodate the maximum amount of electricity that could be generated by the Projects. Therefore, the Projects require two POIs and, consequently, two onshore interconnection cable routes and two landfall sites. To identify the locations of the Projects' onshore facilities, Atlantic Shores conducted an onshore routing assessment through an inter-related process that identified options for landfall sites and onshore interconnection cable routes to existing POIs. Identification of landfall sites and onshore interconnection cable routes in New Jersey is constrained by the density of development along the shorelines and built infrastructure inland. This siting must also account for the area required for horizontal directional drilling (HDD) staging areas as well as the physical dimensions required to install an underground transition vault that connects the export cables and the onshore interconnection cables.

### 3.2.1 Points of Interconnection

Five potential POIs within New Jersey (see Table 3.2-1) were identified based on their proximity to the coastline and their environmental and technical attributes (e.g., substation voltage, potential for expansion, upgrades required to accommodate the Projects' interconnection). These five POIs were used to evaluate potential onshore interconnection cable routes from the landfall sites to the POIs.

---

<sup>15</sup> The corridor spacing guidelines include two navigation paths that are each four vessel lengths wide, two collision avoidance zones that are each 1.5 vessel lengths wide, two safety margins that are each six vessel lengths wide, and a 164 ft (50 m) or 820 ft (250 m) safety zone around each WTG. See Section 8.1 of the NSRA in Appendix II-S for further discussion of allowable transit corridor widths.

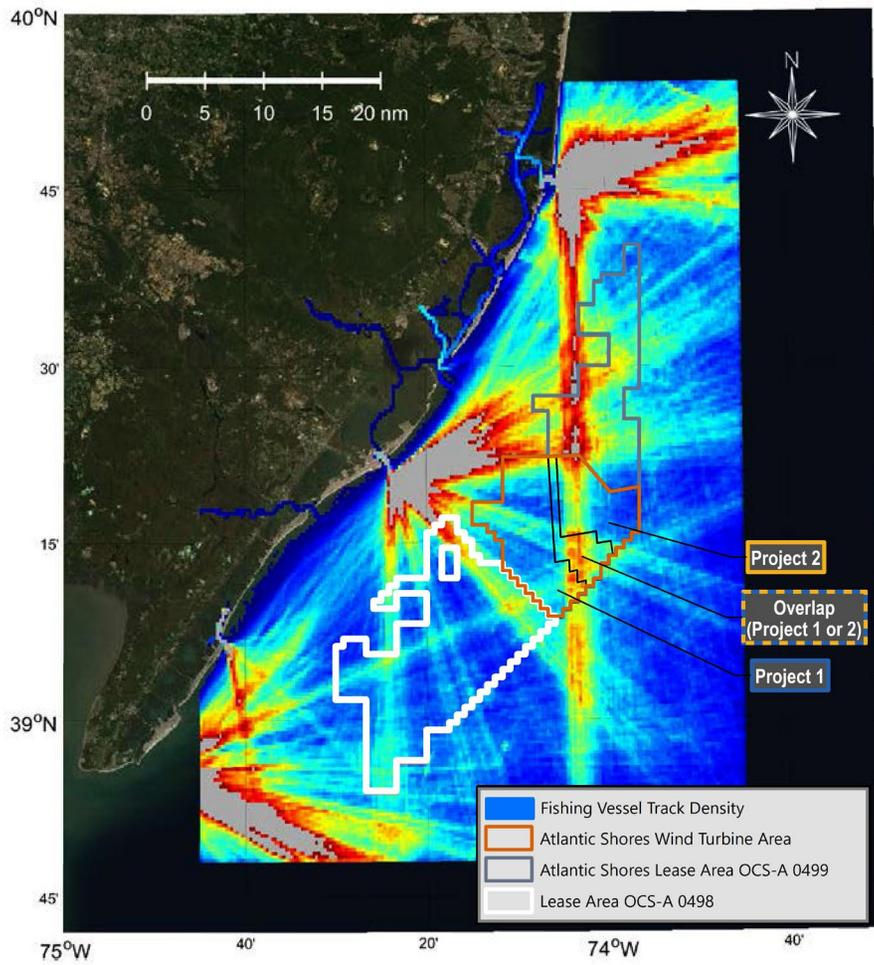

**AIS Fishing Vessel Traffic Density (2017-2019)**

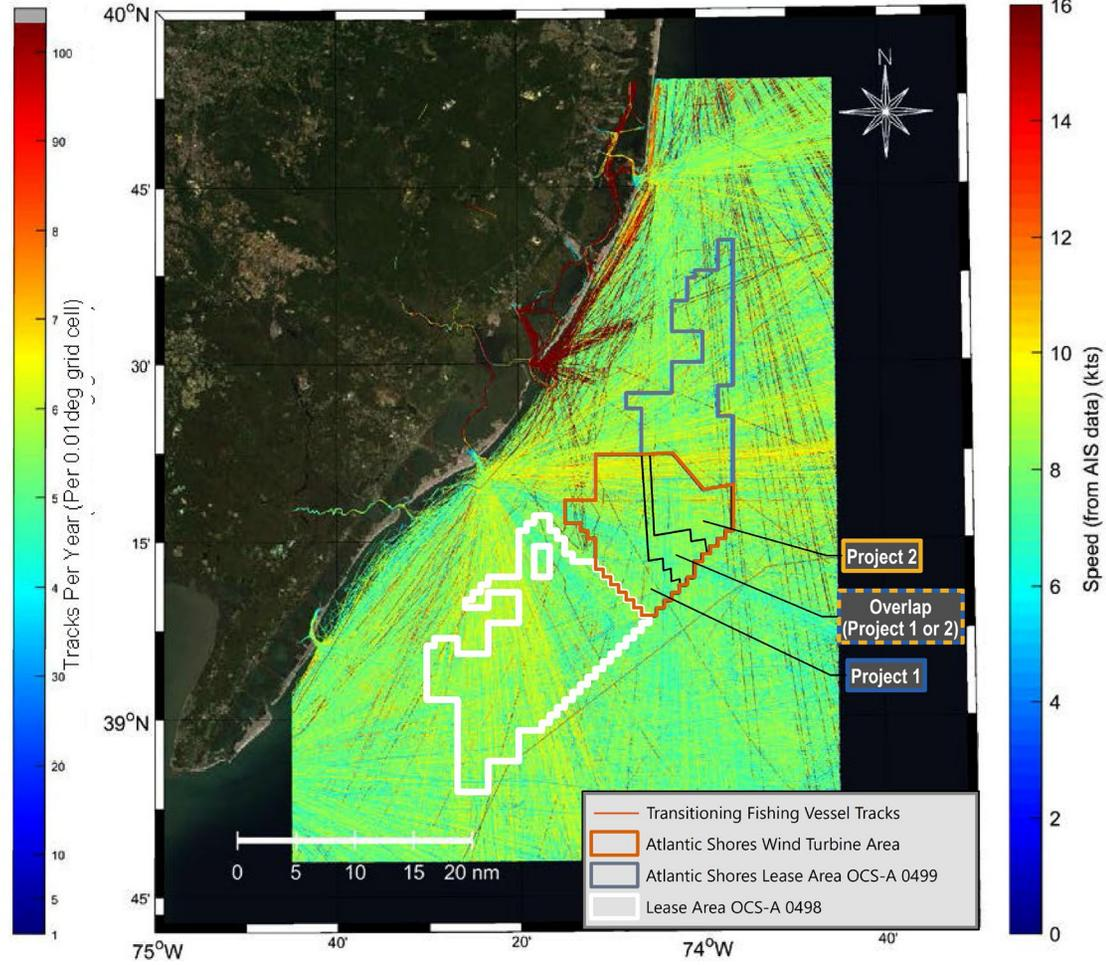

**AIS Transiting Fishing Vessel Tracks (2017-2019)**

Table 3.2-1 Potential Points of Interconnection

Potential POIs	County
Larrabee	Monmouth
Cardiff	Atlantic
Lewis	Atlantic
Oyster Creek	Ocean
BL England	Cape May

### 3.2.2 Landfall Sites

Atlantic Shores conducted a siting evaluation of potential landfall sites that was largely based on parcel size, surrounding land use, and proximity to established linear development corridors (e.g., roadway and utility right-of-way [ROW]) that could serve as an onshore interconnection cable route. The specific siting criteria used to identify potential landfall sites included the following:

- **Technical considerations:**
  - The landfall sites require adequate open space onshore and in proximity to the coastline to accommodate the underground transition vaults and required HDD staging areas.
  - Landfall sites with offshore water depths that are deep enough to accommodate a cable laying vessel at the offshore HDD entrance/exit point are preferred.
- **Site characteristics:** The Projects require areas that are either undeveloped or consist of surface development (i.e., parking lots), without conflicting subsurface infrastructure.
- **Existing uses and sensitive areas:** Preferred landfall sites are not located proximate to residential communities and other sensitive receptors such as wildlife management areas, state parks, and other protected open spaces, which make up most of the open land along the New Jersey coast.

Based on these criteria, aerial photographs of the coastline were manually analyzed to determine candidate landfall sites. A total of 10 potential landfall sites were initially identified, as presented in Table 3.2-2 and shown on Figure 3.2-1.

Table 3.2-2 Landfall Sites

Landfall Site	Potential POI	Approximate Size	Latitude	Longitude
Wesley Lake	Larrabee	<1 acre (<0.004 [square kilometer] km <sup>2</sup> )	40.218344	-74.004783
Monmouth	Larrabee, Oyster Creek	164 acres (0.66 km <sup>2</sup> )	40.121597	-74.033785
Island Beach State Park	Larrabee, Oyster Creek	2,200 acres (8.9 km <sup>2</sup> )	39.904109	-74.081359
Abbott Avenue	Larrabee, Oyster Creek	2 acres (0.008 km <sup>2</sup> )	39.543841	-74.255182
Jeffrey Avenue	Larrabee, Oyster Creek	<1 acre (<0.004 km <sup>2</sup> )	39.539932	-74.259552
Roosevelt Avenue	Larrabee, Oyster Creek	3 acres (0.01 km <sup>2</sup> )	39.534552	-74.262262
North Atlantic City	Cardiff, Lewis	<1 acre (<0.004 km <sup>2</sup> )	39.364038	-74.413007
Bader Airfield	Cardiff, Lewis	143 acres (0.58 km <sup>2</sup> )	39.359757	-74.455573
Atlantic	Cardiff, Lewis	2 acres (0.008 km <sup>2</sup> )	39.351952	-74.450009
Corson's Inlet	BL England	42 acres (0.17 km <sup>2</sup> )	39.216859	-74.642799

### 3.2.3 Onshore Interconnection Routes

From each landfall site, Atlantic Shores conducted an iterative onshore interconnection cable routing assessment to each of the five POIs. The routing assessment was supported by aerial photography, publicly available Geographic Information Systems (GIS) environmental data, and baseline windshield surveys. Based on this routing analysis, 16 preliminary onshore interconnection cable routes were identified as shown in Figure 3.2-1.

A set of environmental and feasibility criteria were identified and weighted to establish and evaluate each onshore interconnection cable route. Route ranking was based on the following criteria:

- **Technical considerations:**
  - Shorter route lengths are preferred to reduce overall potential impacts and installation costs.
  - A lower number of hard route angles requiring a dead-end or corner transmission structure is preferred since hard route angles are more challenging and costly to construct.
- **Site characteristics:** Routes utilizing established ROWs for larger highways, state routes, existing transmission lines, or railroads are preferred because of the widespread development along the coast that prevents the establishment of a new ROW.

8/20/2021 | 1:30:43 Atlantic Shores Offshore Wind COP and Permitting\Graphics\Figures\COP Sectional Project Information\WXD\Figure 3.2-1 Onshore Interconnection Cable Routing Analysis.mxd

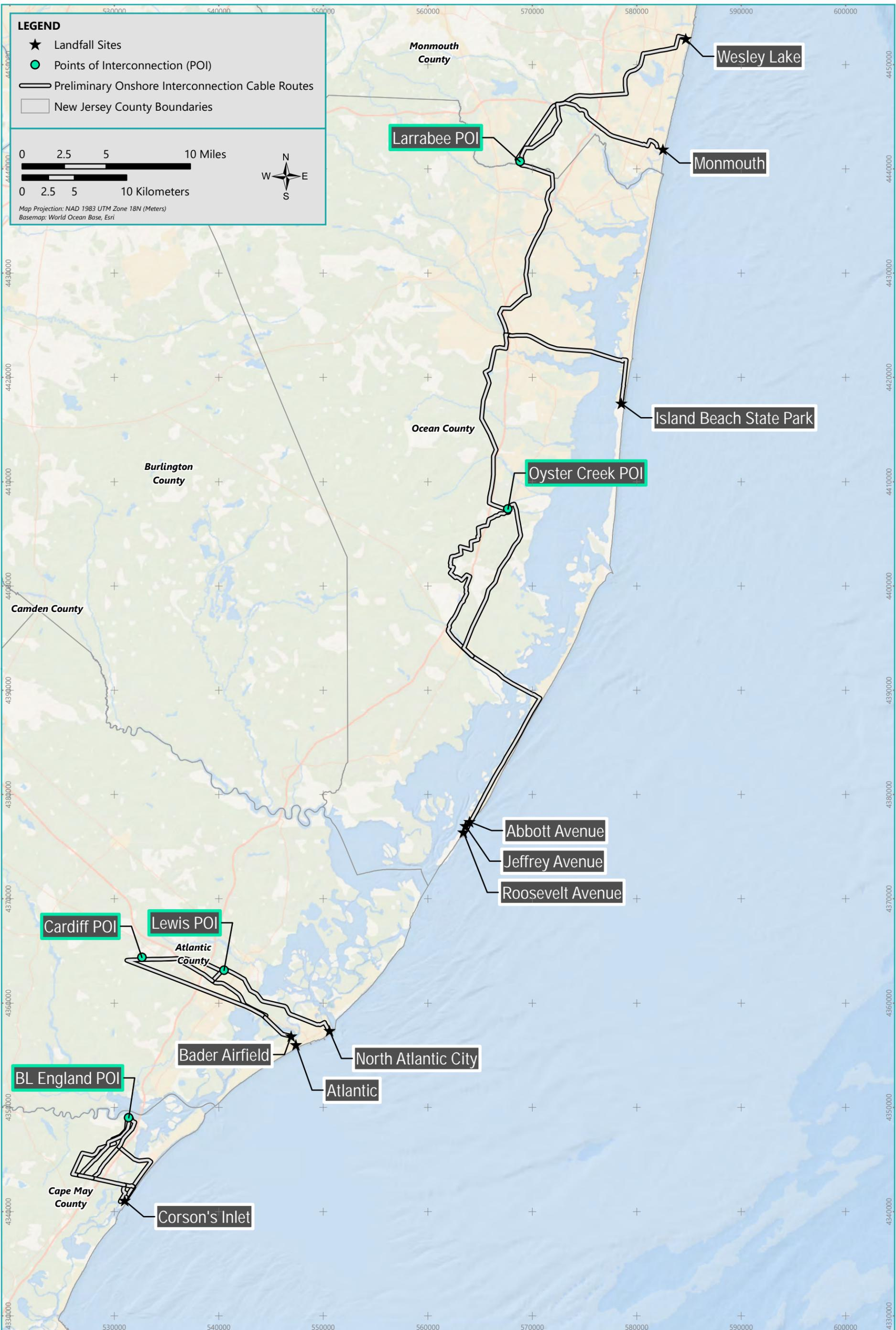

**LEGEND**

- ★ Landfall Sites
- Points of Interconnection (POI)
- Preliminary Onshore Interconnection Cable Routes
- New Jersey County Boundaries

0 2.5 5 10 Miles

0 2.5 5 10 Kilometers

Map Projection: NAD 1983 UTM Zone 18N (Meters)  
Basemap: World Ocean Base, Esri

- **Existing uses and sensitive areas:**

- Routes that avoid or minimize the distance of the onshore interconnection cable route in or within proximity to residential neighborhoods are preferred to reduce temporary, construction-related noise impacts.
- Routes that minimize impacts to mapped threatened and endangered species habitat, tidelands, and wetlands are preferred.

### 3.2.4 Preferred Onshore Interconnection

Based on this evaluation, landfall sites and onshore interconnection cable routes to the Cardiff and Larrabee POIs are preferred. Each provides suitable landfall sites and shorter, more direct routes that utilize existing linear infrastructure with established ROWs and that avoid or minimize impacts to residential and natural areas when compared with other alternatives. Given that multiple routes to both Cardiff and Larrabee POIs were identified, the onshore interconnection cable routes were further analyzed by conducting windshield surveys. Atlantic Shores selected the Monmouth and Atlantic Landfall Sites and the corresponding Larrabee and Cardiff Onshore Interconnection Cable Routes for inclusion in the PDE based on observations made during the windshield surveys, engineering considerations, real estate requirements, and consultation with the New Jersey Department of Environmental Protection (NJDEP) (see Figure 3.2-2).

## 3.3 Export Cable Routing

Atlantic Shores identified nine preliminary export cable routes from the Lease Area boundary<sup>16</sup> to the 10 landfall sites as shown in Figure 3.3-1. The preliminary export cable routes were refined using publicly available data to map routes with the lowest risk for potential conflict with export cable installation. Data sources and criteria used in this analysis included the following:

- **Technical considerations:** The physical attributes of a cable route, such as cable bending radius, length, and distance to installation hazards, were considered in the evaluation of each route.
- **Site characteristics:**
  - Water depth maps were used to confirm feasibility for cable installation tools and to identify any areas of steep slopes, which are not preferred due to expected installation constraints.

---

<sup>16</sup> Atlantic Shores identified preliminary export cable routes that terminated at the Lease Area boundary. Once preferred export cable routes were identified, they were extended to the WTA boundary.

8/20/2021 | 1:32:03 Atlantic Shores Offshore Wind COP and Permitting\Graphics\Figures\COP Sections\Project Information\WAD\Figure 3.2-2 Preferred Onshore Interconnection Cable Routes.mxd

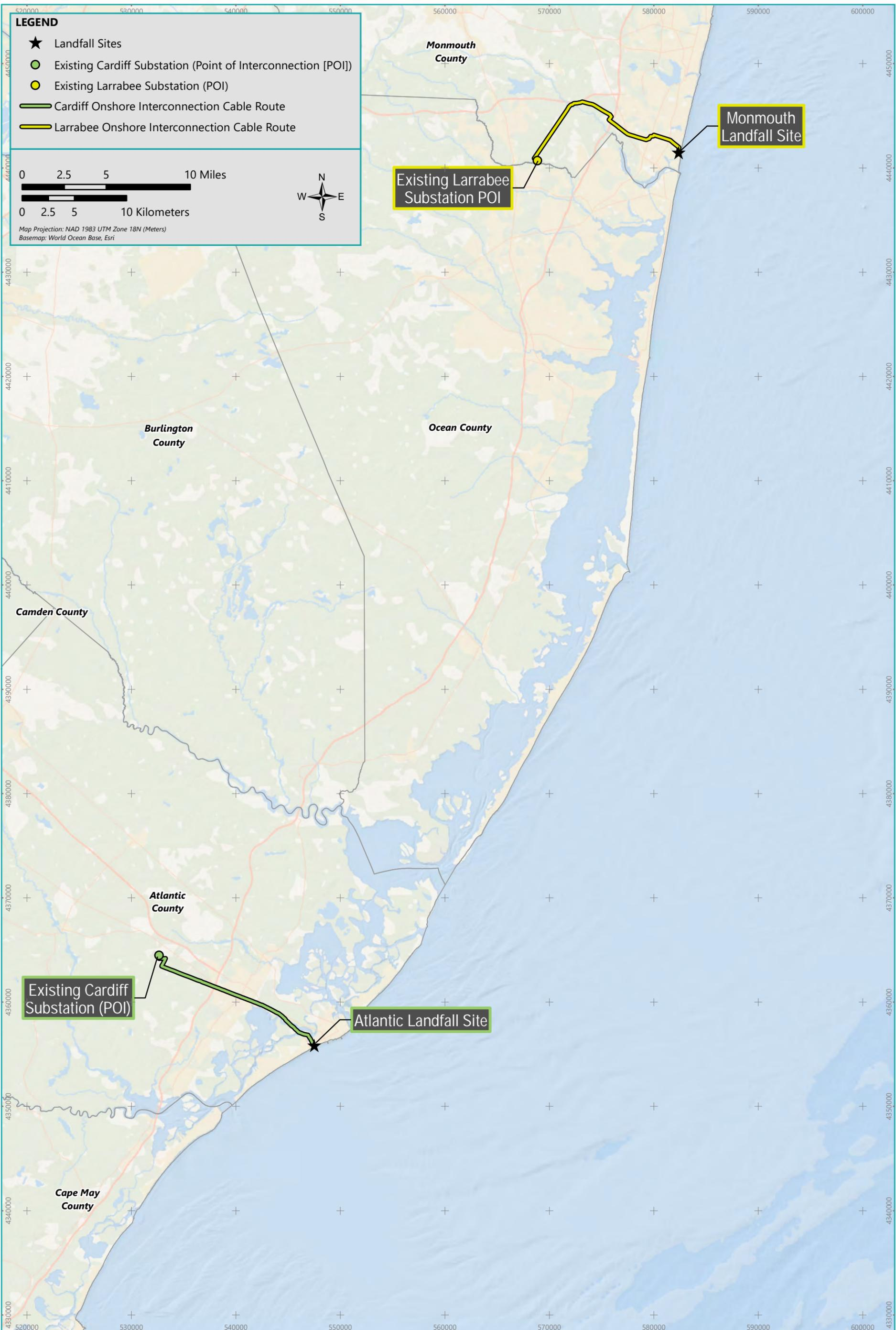



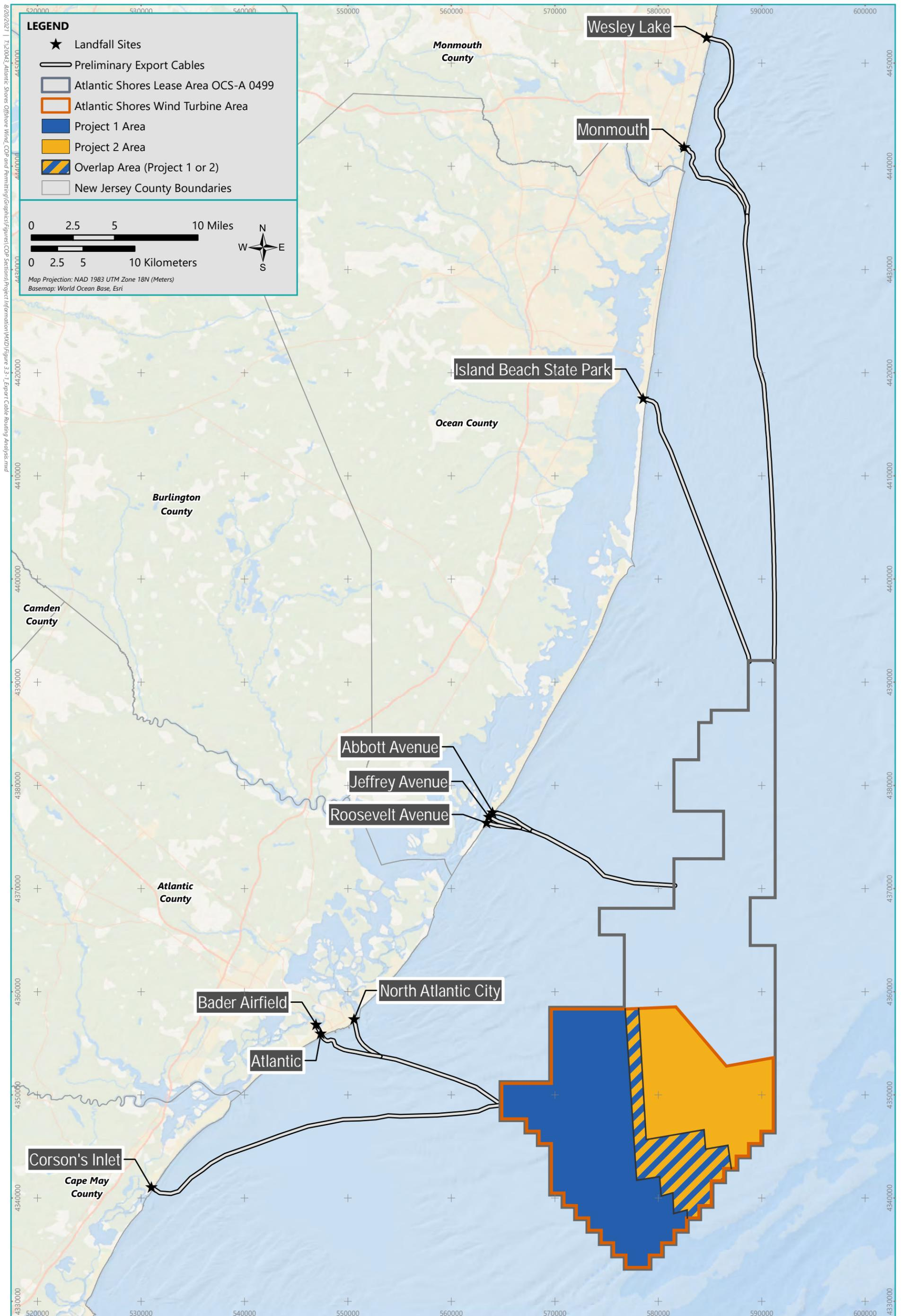

8/20/2021 | 1:20:43 Atlantic Shores Offshore Wind COP and Permitting\Graphics\Figures\COP sections\Project Information\WXD\Figure 3-1\_Export Cable Routing Analysis.mxd

**LEGEND**

- ★ Landfall Sites
- Preliminary Export Cables
- ▭ Atlantic Shores Lease Area OCS-A 0499
- ▭ Atlantic Shores Wind Turbine Area
- ▭ Project 1 Area
- ▭ Project 2 Area
- ▭ Overlap Area (Project 1 or 2)
- ▭ New Jersey County Boundaries

0 2.5 5 10 Miles

0 2.5 5 10 Kilometers

Map Projection: NAD 1983 UTM Zone 18N (Meters)  
 Basemap: World Ocean Base, Esri

- Publicly identified surficial and shallow geological characteristics were used to confirm feasibility for cable installation tools and to assess whether mobile sediments were present; areas of mobile sediments are not preferred because they may pose a risk of over-burial or exposure of the cable. Sandy sediments are preferred over rocky, stiff, or very fine sediments to ensure cable burial to a sufficient depth.
- **Existing uses and sensitive areas:**
  - Cable routes that avoid mapped shipwrecks are preferred to reduce impacts to cultural resources and potential installation challenges.
  - Cable routes that avoid navigation channels or cross such channels as close to perpendicular as possible to minimize the crossing distance are preferred.
  - Cable routes that avoid or minimize impacts to sensitive habitats for fish and other marine wildlife, such as artificial and natural reefs and other known critical habitat locations, are preferred.
  - Cable routes that avoid or minimize the number of crossings of mapped offshore cables and pipelines, or known future offshore cables, are preferred. If a crossing is required, a route that allows the crossing to be as close to perpendicular as possible (to minimize the crossing distance) is preferred.
- **Hazards:**
  - Cable routes were selected to avoid known hazards, including rock outcrops, submerged infrastructure, and other structures or objects that present a hazard to vessel navigation.
  - Cable routes were selected to avoid mapped munitions and explosives of concern (MEC) (e.g., bombs, bullets, shells, grenades, mines, etc.) and military areas given safety considerations.
  - Cable routes were selected to avoid dredged material disposal areas and dumping grounds given the potential for cable installation constraints and the presence of contaminated sediments.

The preliminary export cable routes incorporated the above criteria to the maximum extent practicable. Atlantic Shores also considered the shortest technically feasible corridor length to minimize electrical line losses, the cost and complexity of cable installation, and environmental impacts associated with cable installation. Ultimately, the above assessment identified feasible export cable routes to both the Atlantic and Monmouth Landfall Sites, as shown on Figure 3.3-2. The export cable routes to the Atlantic and Monmouth Landfall Sites are preferred because they connect to the preferred landfall sites and POIs identified in Section 3.2.4.

8/20/2021 | 1:20:43 Atlantic Shores Offshore Wind, CO2 and Permitting\Graphics\Figures\COP Sectional Project Information\WAD\Figure 3.3-2 Preferred Offshore Export Cable Routes.mxd

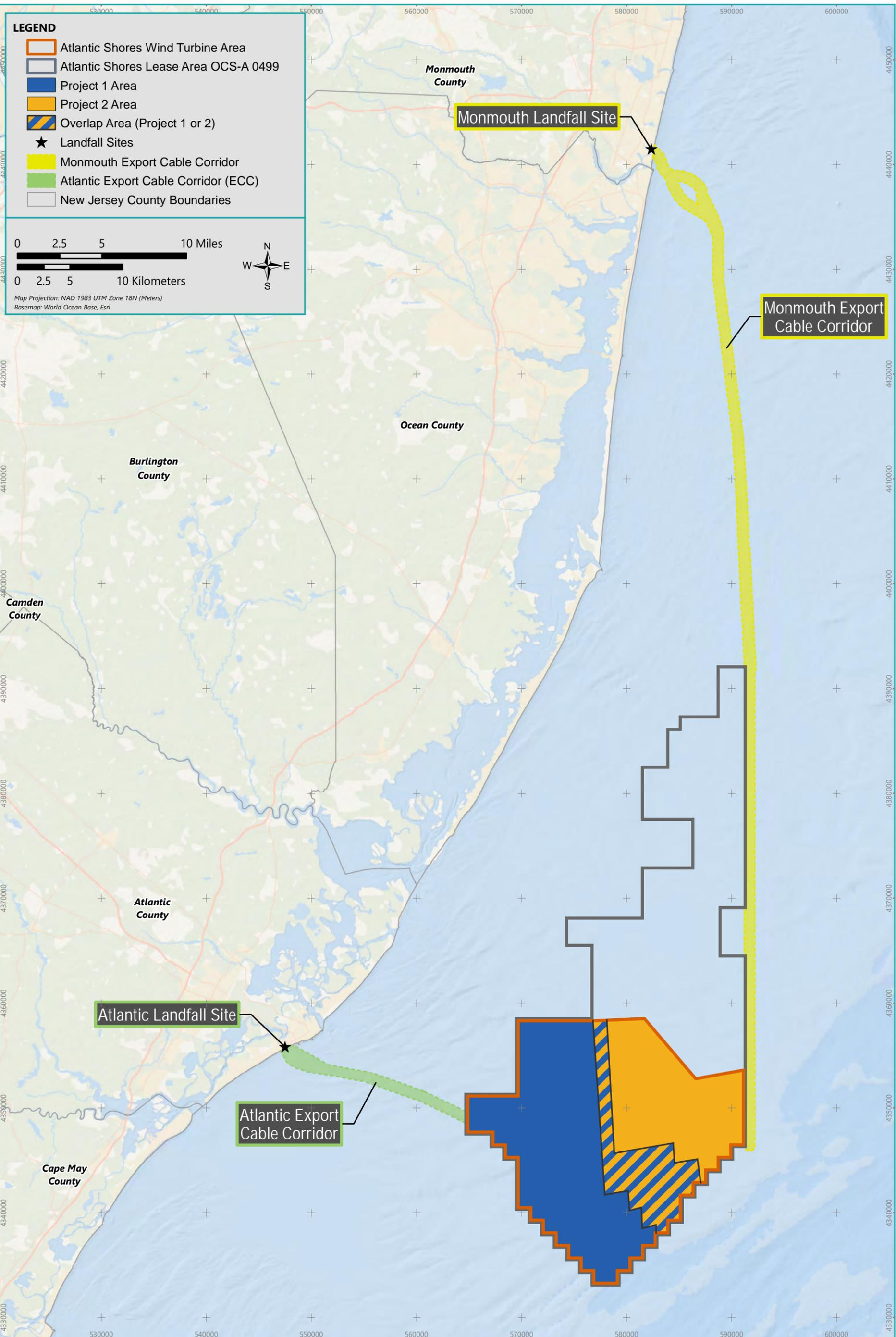

The export cable routes to the Monmouth and Atlantic Landfall Sites, as shown on Figure 3.3-2, were further refined and developed into the Monmouth and Atlantic Export Cable Corridors (ECCs). The width of each ECC ranges from approximately 3,300 to 4,200 ft (1,000 to 1,280 m) for all of the Monmouth ECC and most of the Atlantic ECC, though the Atlantic ECC widens to approximately 5,900 ft (1,800 m) near the Atlantic Landfall Site (see Figure 1.1-2 and Section 4.5.2.1). Atlantic Shores is defining this corridor width to provide flexibility in the early stages of the geophysical and geotechnical evaluation of each ECC. Such an approach is consistent with recommended best practices for cable spacing at a project's initial permitting phase (such as DNV GL [2016]). Maintaining this corridor width allows Atlantic Shores to optimize final cable alignments within the corridor to avoid resources, such as shipwrecks and sensitive habitats, to the greatest extent possible. This width also provides adequate space for cable installation vessels and any associated anchoring lines (i.e., to ensure any anchoring occurs within the surveyed corridor), particularly near the landfall sites where anchoring may be required.

Specific cable alignments within the ECCs will be optimized pending ongoing analysis of geophysical and geotechnical data as part of the cable route engineering process. Once the cable route engineering process has sufficiently progressed, Atlantic Shores will formally request offshore cable easement(s) from BOEM. In order to provide the minimum required spacing between the four export cables in each ECC (see Section 4.5.2.1) and to allow adequate room for potential future cable repairs, Atlantic Shores anticipates requiring an easement within each ECC that is wider than the 200 ft (61 m) width listed in 30 CFR §§ 585.507(1) and 585.628(g). Atlantic Shores will coordinate with BOEM on the easement request.

### 3.4 Foundation Type Selection

Atlantic Shores is considering fixed foundation types for both the WTGs and the OSSs. An extensive evaluation of all viable foundation types was undertaken. This evaluation of foundation types considered the following:

- **Technical and logistical considerations:**
  - Each potential foundation's ability to support the sizes of the OSS topsides and WTGs included within the PDE was assessed.
  - Construction logistics for each potential foundation type were reviewed to evaluate the feasibility of each foundation type, including the availability of suitable ports within reasonable proximity to the WTA.
  - Each potential foundation's market availability was assessed.
- **Site characteristics:** Seafloor conditions, sediment characteristics, meteorological and oceanographic (metocean) conditions, and water depths within the WTA were used to evaluate the suitability of potential foundation types for the site.

Based on this analysis, Atlantic Shores determined that piled, suction bucket, and gravity foundations are all suitable to include in the PDE (see Sections 4.2 and 4.4). Any fixed foundation designs that are not technically mature or are not expected to be commercially available in time

for the Projects' expected development schedules were omitted from further evaluation. It should be noted that floating foundations were not considered because water depths in the WTA are too shallow for those options to be technically and economically viable.

To determine the sizing of the foundations, a combination of industry benchmarking and engineering studies was conducted using multiple WTG sizes and site-specific data for the WTA (e.g., metocean criteria and preliminary sediment profiles).

Overall, the WTA is suited for a range of foundation types due to its shallow water depths, favorable geotechnical and geophysical conditions (see Section 2.0 Environmental Setting of Volume II), and proximity to local ports and industry (see Section 4.10.3). All concepts identified in the PDE are technically feasible and sized to capture the potential development scenarios.

### 3.5 WTG Dimension Selection

Atlantic Shores conducted a market assessment to identify WTGs anticipated to be commercially available within the Projects' expected development schedules. To perform this evaluation, Atlantic Shores worked with three global leading suppliers to assess historic and projected market trends. As part of assessing the potential WTGs that may be available, Atlantic Shores also considered the following key criteria:

- **Technical considerations:** The Projects require high reliability and sufficient energy yield.
- **Site characteristics:** The Projects require WTGs that are suitable for the expected metocean conditions at the WTA, including severe weather events such as hurricanes.

The WTG dimensions included in the PDE are indicative of the maximum dimensions of WTGs anticipated to be commercially available within the Projects' expected development schedules. As shown on Figure 3.5-1, WTG sizes are increasing significantly every few years. Within the last decade (2010-2020), rotor diameters have nearly doubled—increasing from an average of 295 ft (90 m) to an average of 538 ft (164 m). The rapid pace of increasing WTG size is apparent in the first few existing and planned projects in the U.S. The Block Island Wind Farm completed installation in 2016 and includes five, 6 megawatt (MW) WTGs (Green City Times 2020). The Coastal Virginia Offshore Wind project completed installation four years later in 2020 and includes two, 6 MW WTGs (Windfair 2020). The Vineyard Wind 1 project expects to complete installation by the end of 2023 and includes 13 MW WTGs (Vineyard Wind 2020). Such increases in WTG sizes are expected to continue into the next decade and beyond, especially as more offshore wind projects are announced and constructed. Given current trends, smaller turbines (such as 10 to 12 MW WTGs) are expected to be phased out from commercial use by the Projects' expected development timeframe.

## Offshore wind

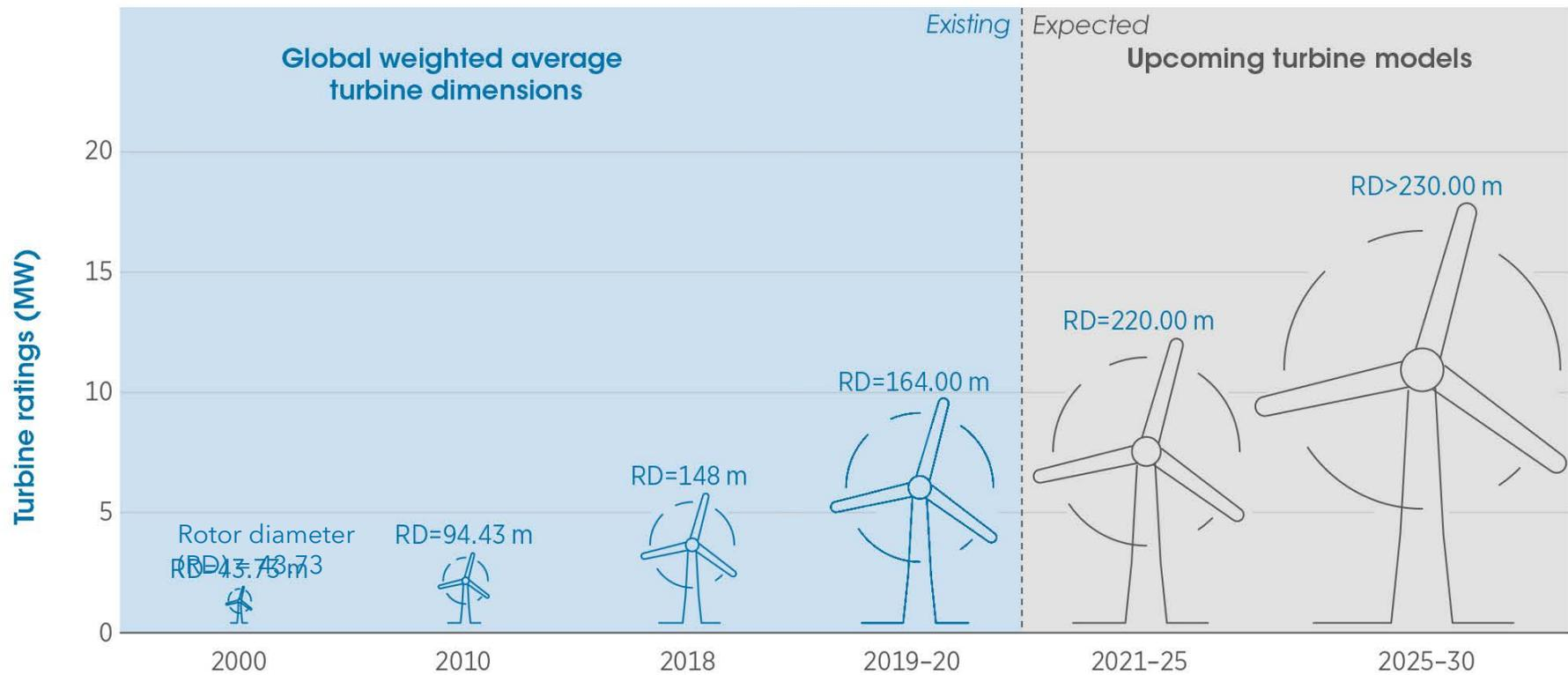

Source: Adapted from IRENA, 2019; IRENA, 2019c, 2016b; MHI Vestas, 2018.

The PDE for WTGs includes the maximum rotor diameter and rotor area, blade tip height, and hub height for WTGs that may be commercially available, as well as a minimum blade tip clearance that may occur, but it is not expected that the extreme range of the PDE for each component would be used in any selected WTG. Ultimately, the use of a PDE allows Atlantic Shores to define a range of dimensions for WTGs expected to be commercially available within the Projects' development schedule so that Atlantic Shores has the flexibility to utilize available technology at the time of construction without permitting delays.

## 4.0 Project Design and Construction Activities

This section provides a detailed description of the Projects' facilities (see Figure 1.1-2), which have been selected for the Project Design Envelope (PDE) based on the siting and design evolution process outlined in Section 3.0. This section also outlines the Projects' construction sequence and schedule along with a detailed description of the design of each major component of the Projects (e.g., wind turbine generator [WTGs], offshore substations [OSSs], offshore cables, onshore facilities) and the process for construction and installation.

### 4.1 Infrastructure Overview and Schedule

#### 4.1.1 Project Design Envelope Overview

The Projects include the following elements:

- Up to 200 WTGs, each with a maximum rotor diameter of approximately 919 feet (ft) (280 meters [m]), will be installed on three main foundation types (piled, suction bucket, and gravity foundations) (see Sections 4.2 and 4.3).
- A combined maximum of up to 200 wind turbine generators (WTGs) inclusive of the Overlap Area<sup>17</sup>:
  - Project 1: a minimum of 105 WTGs to a maximum of 136 WTGs.
  - Project 2: a minimum of 64 WTGs to a maximum of 95 WTGs.
- Up to 10 small offshore substations (OSSs), up to five medium OSSs, or up to four large OSSs will serve as common collection points for power from the WTGs and also serve as the origin for the export cables that deliver power to shore (see Section 4.4).
  - Project 1: up to five small OSSs, two medium OSSs, or two large OSSs.
  - Project 2: up to five small OSSs, three medium OSSs, or two large OSSs.
- Up to 547 miles (mi) (880 kilometers [km]) of high voltage alternating current (HVAC) inter-array cables will connect strings of WTGs to a shared OSS (see Section 4.5).
  - Project 1: up to 273.5 mi (440 km) of HVAC inter-array cables.
  - Project 2: up to 273.5 mi (440 km) of HVAC inter-array cables.

---

<sup>17</sup> The number of WTGs in Project 1, Project 2, and the associated Overlap Area will not exceed 200 WTG locations. For example, if Project 1 includes 105 WTGs (the minimum) then the Overlap Area would be incorporated into Project 2 which would include the remaining 95 WTGs; and conversely if the Overlap Area is incorporated into Project 1 such that it includes 136 WTGs, then Project 2 would be limited to 64 WTGs. Each Project may also use only part of the Overlap Area.



- Up to 37 mi (60 km) of HVAC inter-link cables may be used to connect OSSs to each other (see Section 4.5).
  - Project 1: up to 18.6 mi (30 km) of HVAC inter-link cables connecting to OSSs.
  - Project 2: up to 18.6 mi (30 km) of HVAC inter-link cables connecting to OSSs.
- Up to eight total HVAC and/or HVDC export cables will be installed in two offshore Export Cable Corridors (ECCs), the Atlantic ECC and the Monmouth ECC, that are each approximately 3,300 to 4,200 ft (1,000 to 1,280 m) wide (see Section 4.5).
  - The length per cable is approximately 25 mi (40 km) in the Atlantic ECC.
  - The length per cable is approximately 85 mi (138 km) in the Monmouth ECC.
- Up to one permanent meteorological (met) tower and up to four temporary meteorological and oceanographic (metocean) buoys may be installed within the Wind Turbine Area (WTA) (see Section 4.6).
  - Project 1: one permanent met tower and up to three temporary metocean buoys
  - Project 2: up to one temporary metocean buoy
- The Projects will utilize either or both of two onshore interconnection cable routes, which will each contain up to 12 onshore interconnection cables that are installed within buried concrete duct banks (see Sections 4.7 and 4.8).
  - The Cardiff Onshore Interconnection Cable Route is approximately 12 mi (19 km).
  - The Larrabee Onshore Interconnection Cable Route is approximately 12 mi (19 km).
- The Projects will utilize either or both of two onshore substation sites (one for each point of interconnection [POI]); the substations will step-up or step-down the onshore interconnection cable voltage in preparation for grid interconnection (see Section 4.9).
- The Cardiff POI is located in Atlantic County, New Jersey, and the Larrabee POI is located in Monmouth County, New Jersey.
- A proposed new operations and maintenance (O&M) facility in Atlantic City, New Jersey will support the Projects' operations (see Section 5.5).
- Existing port facilities in New Jersey, New York, the Mid-Atlantic, New England, the U.S. Gulf Coast, and/or overseas will be used to support the Projects' construction and operations (see Sections 4.10.3 and 5.5).

#### 4.1.2 Project Construction Process and Schedules

The proposed construction schedule is shown in Table 4.1-1. To maximize construction synergy and efficiency, the construction schedules for Project 1 and Project 2 assumes the same installation teams and equipment (e.g., vessels) will be used to support the construction of both Projects. This strategy will limit demobilization and remobilization of equipment and crews which will help to reduce construction costs, increase schedule efficiency, and minimize environmental effects (e.g., emissions, vessel transits). This procedure will also provide continuous fabrication in manufacturing facilities to maintain employment and increase productivity. It will also reduce delays in the Federal permitting schedule tied to a Project’s Final Investment Decision (FID) and allow Atlantic Shores to secure production slots. This strategy would also result in significant benefits to ratepayers, which is a critical component of state OREC solicitations.

Table 4.1-1 Anticipated Construction Schedule

Activity	Duration <sup>a</sup>	Expected Timeframe <sup>b</sup>	Project 1 Start Date	Project 2 Start Date
Onshore Interconnection Cable Installation	9 - 12 months	2024 - 2025	Q1-2024	Q1-2024
Onshore Substation Construction	18 - 24 months	2024 - 2026	Q1-2025	Q1-2025
Export Cable Installation	6-9 months	2025	Q2-2025	Q3-2025
OSS Installation and Commissioning	5-7 months	2025 - 2026	Q2-2026	Q2-2026
WTG Foundation Installation <sup>c</sup>	10 months	2026 – 2027	Q1-2026	Q1-2026 <sup>c</sup>
Inter-Array Cable Installation	14 months	2026 - 2027	Q2-2026	Q3-2026 <sup>d</sup>
WTG Installation and Commissioning	17 months	2026 - 2027	Q2-2026	Q1-2027 <sup>d</sup>

Notes:

- a) These durations assume continuous foundation structure installation without consideration for seasonal pauses or weather delays; anticipated seasonal pauses are reflected in the expected timeframe.
- b) The expected timeframe is indicative of the most probable duration for each activity; the timeframe could shift and/or extend depending on the start of fabrication, fabrication methods, and installation methods selected.
- c) The expected timeframe depends on the foundation type. If piled foundations are utilized, pile-driving will follow a proposed schedule from May to December to minimize risk to North Atlantic Right Whale. No simultaneous pile driving is proposed.
- d) The expected timeframe is dependent on the completion of the preceding Project 1 activities (i.e., Project 1 inter-array cable installation and WTG installation) and the Project 2 foundation installation schedule.

As shown in Figure 4.1-1, construction of each Project will initiate with the onshore facilities, including the onshore substations and onshore interconnection cables. The onshore facilities for each Project will be constructed first so that power from the electrical grid can be used to energize, commission, and maintain each Project's offshore facilities (e.g., the OSSs and WTGs) as soon as possible after their installation. Construction of the offshore facilities is expected to begin with installation of the export cables and the WTG and OSS foundations (including scour protection). Once the OSS foundations are installed, the topsides can be installed and commissioned, and the inter-link cables (if used) can be installed. At each WTG position, after the foundation is installed, the associated inter-array cables and WTGs can be installed (if WTGs are not installed onto gravity-base structure [GBS] foundations at port). Given the number of WTG and OSS positions, there is expected to be considerable overlap in the various equipment installation periods. Installation of the Projects' onshore and offshore facilities may occur over a period of up to 3 years (to accommodate weather and/or seasonal work restrictions); offshore construction is expected to last approximately 2 years.

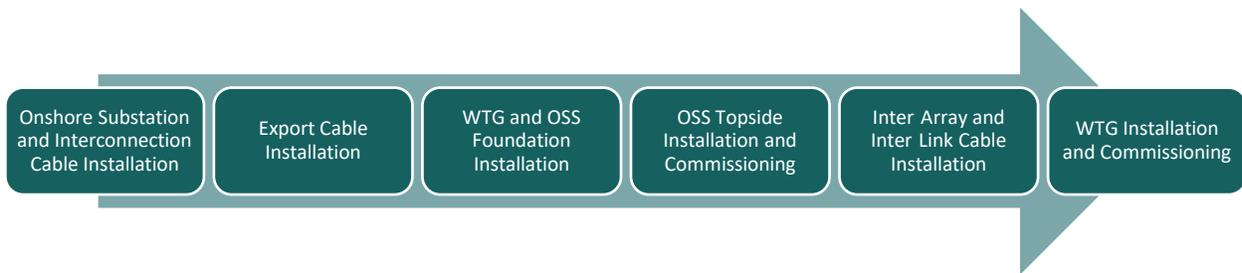

Figure 4.1-1 General Project Construction Sequence

High resolution geophysical and geotechnical surveys will be conducted to verify site conditions prior to offshore construction and geophysical surveys will be conducted post-construction to ensure proper installation of the components of each Project. Geophysical survey equipment may include side-scan sonar, multibeam echo-sounder, magnetometers, gradiometers, and sub-bottom profilers. Based on the results of a munitions and explosives of concern (MEC) desktop study (see Appendix II-A) and based on final facility siting and engineering design, the Projects may also elect to include a MEC study as part of the Projects' pre-construction geophysical survey campaign. Geotechnical surveys to inform the final design and engineering of each Projects' offshore facilities may include vibracores, cone penetrometer tests, and deep borings. Geotechnical surveys will only be performed in areas that are surveyed and cleared for cultural resources.

Environmental monitoring surveys will be conducted pre-construction, during construction, and post-construction to support the assessment of the Projects' potential effects. The environmental monitoring survey plans are being developed in consultation with federal, state, and local agencies, non-governmental organizations, and other relevant stakeholders and may be conducted as part of regional monitoring initiatives. These surveys and plans are identified and discussed further in Volume II.

Before starting any onshore work, the Project Companies will each coordinate as appropriate with municipalities and work to inform members of the public regarding onshore construction locations and schedules (see Section 1.4). Prior to performing any offshore work, The Projects will adhere to its Fisheries Communication Plan (FCP) (see Appendix II-R) and will reach out to its fishing industry contacts to avoid and minimize interactions with fishing vessels and fishing gear. Each Project Company will coordinate with the U.S. Coast Guard (USCG) to issue Notices to Mariners to inform fishermen and other mariners of the Projects' activities.

## 4.2 Wind Turbine Generator Foundations

The WTG foundations will provide a robust, stable, and level base for the WTG towers. The foundations will also provide personnel access (via boat landings, ladders, and work platforms), contain aids to navigation in accordance with USCG and the Bureau of Ocean Energy Management (BOEM) requirements (see Section 5.3), include a crane for transferring materials and equipment, and house electrical equipment. The PDE includes three categories of WTG foundations that may be affixed to the seabed using piles, suction buckets, or gravity:

1. **Piled foundations:** monopiles or piled jackets;
2. **Suction bucket foundations:** mono-buckets, suction bucket jackets, or suction bucket tetrahedron bases; and
3. **Gravity foundations:** GBS or gravity-pad tetrahedron bases.

The following sections describe each WTG foundation type, and the foundation installation processes for each type.

### 4.2.1 Piled Foundations

The PDE for the Projects includes two sub-types of piled foundations. The PDE of dimensions for each foundation sub-type is provided in Table 4.2-1 (see Section 4.2.6).

- **Monopiles:** Monopile foundations, which are driven into the seabed, typically consist of a single steel tube composed of several sections of rolled steel plates that are welded together. A transition piece may be mounted on top of the monopile (see Figure 4.2-1). Alternatively, the monopile length may be extended to the interface with the WTG tower; this is referred to as an "extended monopile." The transition piece or the top of the

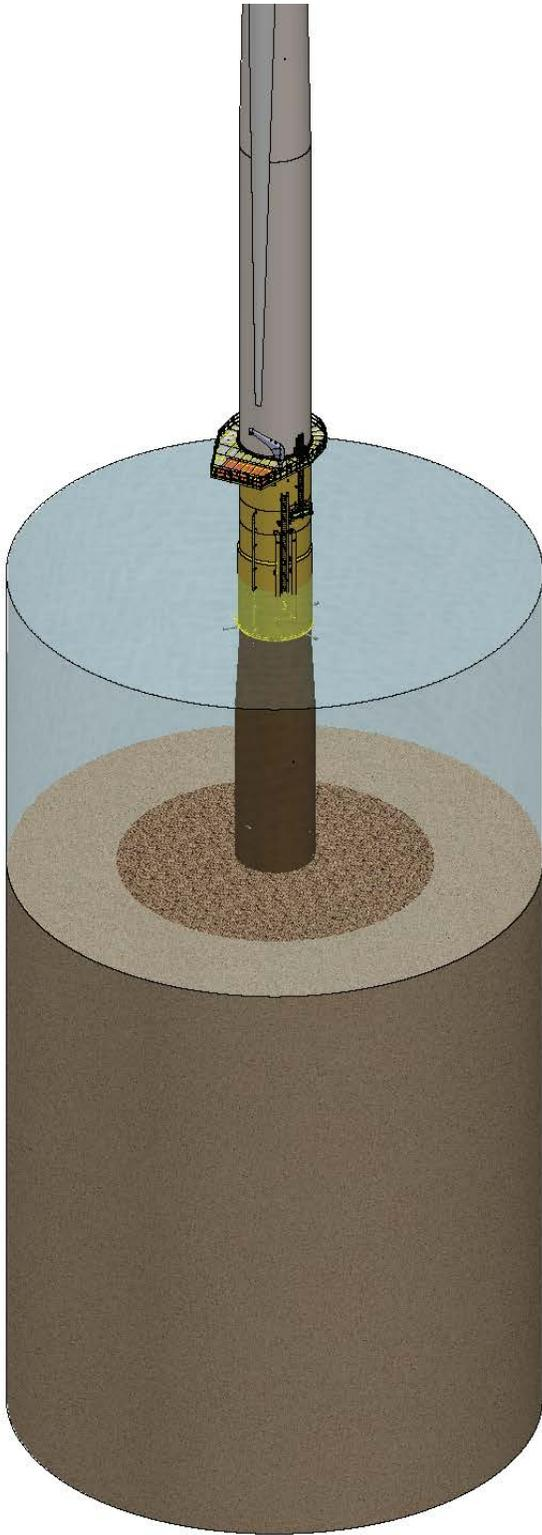

**Monopile**

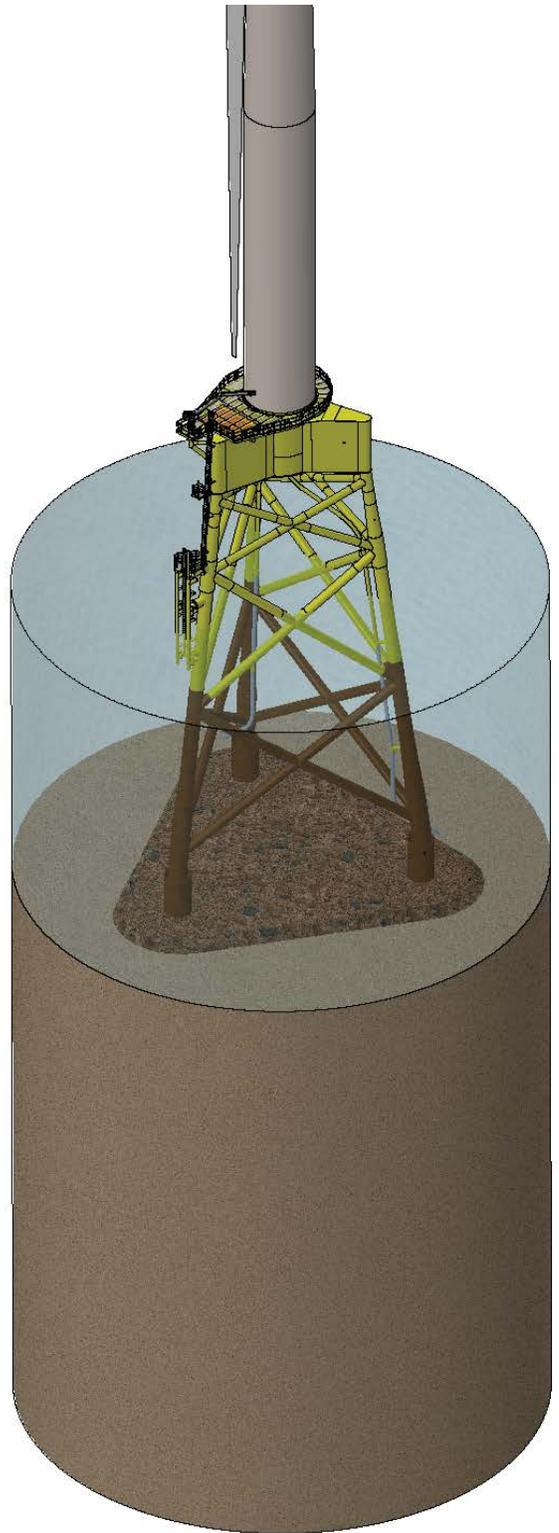

**Piled Jacket**

extended monopile contains a flange for connection to the WTG tower and may include secondary structures such as a boat landing, ladders, a work platform, a crane, and other ancillary components. If a transition piece is used, it will be secured to the monopile via bolts, grout, a slip joint, and/or other mechanical joint connections. The monopile's top diameter and transition piece's bottom diameter are sized based on site-specific environmental and functional loads. The upper outer diameter of the transition piece is identical to the WTG tower's bottom diameter.

- **Piled jackets:** Piled jacket foundations are steel lattice structures comprised of tubular steel members and welded joints that are fixed to the seabed using piles connected to each leg of the jacket (see Figure 4.2-1). Piled jacket foundations may include three or four legs. Typically, piles are hollow steel cylinders that are driven into the seabed. The top of the jacket foundation contains a flange for connection to the WTG tower as well as secondary structures such as a boat landing, ladders, a work platform, a crane, and other ancillary components.

The Projects' monopiles or piled jacket components may be fabricated either in the U.S. or overseas and will be delivered either directly to the WTA or to a marshalling port for final assembly and staging. If storage at a marshalling port is required, equipment such as crawler cranes or self-propelled modular transporters (SPMTs) will be used to unload and transport foundations within the marshalling port. Depending on the location of fabrication and any subsequent staging activities, foundation components may be transported to the marshalling port or WTA by heavy transport vessels (HTVs), ocean-going barges, jack-up feeder vessels, or smaller feeder barges towed by local tugboats (see Figure 4.2-2 and Section 4.10.1).

Monopile and piled jacket design and installation methods may require seabed preparation prior to installation (see Section 4.2.4). Scour protection may be required and would be installed at the base of the monopiles or piled jackets (see Section 4.2.5).

At the WTA, piled foundations will be installed using one or two jack-up vessels or heavy-lift vessels (HLVs) using dynamic positioning (DP) or anchoring. At each foundation location, a crane on the installation vessel will lift the monopile or each piled jacket component from the transportation vessel into a vertical position and lower it to the seabed (see Figure 4.2-2).

Jacket foundations may have either pre-installed piles or post-installed piles. If pre-installed, a template will be used to properly position the piles so they can be driven into the seabed before the jacket arrives at the WTA. The jacket will then be lifted by a vessel crane and set directly onto the installed piles. If post-installed, a vessel crane will lift the jacket foundation and place it on the seabed, after which pin piles will be driven through the jacket's pile sleeves to secure it in place. Mud mats may be used for piled jackets during installation to support the jacket during piling.



**Pile Driving of a Monopile**



**Transition Piece Installation from a Jack-Up Vessel**



**Monopile Transport via Tugboat and Barge**



**Pile Driving of a Jacket Pile**

Once the monopile or jacket pin pile is lowered to the seabed, the weight of the pile itself will cause the pile to sink a distance into the seabed (but not to target penetration depth). With the pile resting on the seabed, the crane will release the pile and place a hydraulic hammer atop the pile in preparation for pile-driving. The maximum expected hammer size for installation of monopiles is up to 4,400 kilojoules (kJ) whereas the maximum expected hammer size for jacket pin piles is 2,500 kJ. It is anticipated that it will take a maximum of 7 to 9 hours to drive one monopile and that a maximum of 2 monopiles could be driven per day per vessel spread assuming no daylight restrictions (see the PDE in Section 4.2.6). For jackets, it is expected that the maximum installation rate will enable installation of all pin piles for a single jacket foundation (i.e., three or four piles) per day. A description of measures to mitigate underwater noise while pile-driving is provided in Section 4.7.2 of Volume II.

During pile driving, a gripper frame may be used to stabilize the foundation for piling. A vibratory pile driver may also be used at the beginning of pile driving to support embedment of the pile until it is stable enough for pile driving.

While not anticipated, drilling for pile installation may be required if pile driving encounters refusal (e.g., due to bedrock or a large boulder). This operation involves placing a rotary drilling unit on top of the pile to drill out material from the internal diameter of the pile so pile driving can continue. Material drilled out of the inner diameter of the pile is expected to be deposited adjacent to any scour protection<sup>18</sup> and may be transferred into the pile after the operation is complete to provide additional stability. The pile may also be filled with sand, grout, or concrete.

Following installation of a monopile, a vessels' crane will lift the transition piece (if used) onto the monopile, and the joint will be secured with grout, bolts, a slip joint, other mechanical joint, or a combination of these methods. If used, grout will be mixed onboard a vessel and pumped into the transition piece above a high-strength rubber grout seal to avoid leakage.

For jacket foundations, once the pin piles are driven to their target depths, the installation vessel will ensure the foundation is level and the piles will be fixed in place with grout. Grout will fill each pile sleeve, but the procedure will be monitored to ensure that grout does not spill over the sleeve. For both monopile and jacket foundations, proper grouting procedures will be utilized to minimize any overflow.

Any anchoring or jacking-up during WTG foundation installation will always occur within surveyed areas of the WTA. The PDE of seabed disturbance for monopile and piled jacket foundation installation is described in Table 4.2-1.

---

<sup>18</sup> Any drilled material deposition adjacent to scour protection will occur within the maximum seabed disturbance footprint presented in Section 4.11.



## 4.2.2 Suction Bucket Foundations

The PDE includes three variations of suction bucket foundations. The PDE of dimensions for each foundation variation is provided in Table 4.2-1 (see Section 4.2.6).

- **Mono-buckets:** A mono-bucket consists of a single suction bucket supporting a single steel or concrete tubular structure (similar to a monopile) upon which the WTG is mounted. The suction bucket is typically a hollow steel cylinder that is capped at the upper end; the open end of the bucket faces downward into the seabed (see Figure 4.2-3). A transition piece may be mounted on top of the mono-bucket (similar to the monopile foundation type described in Section 4.2.1).
- **Suction bucket jackets:** Suction bucket jacket foundations are steel lattice structures comprised of tubular steel members and welded joints that are fixed to the seabed by suction buckets installed below each leg of the jacket (see Figure 4.2-3). The suction bucket jacket may have three or four legs. Similar to piled jacket foundations, the top of the jacket foundation contains a flange for connection to the WTG tower as well as secondary structures such as a boat landing, ladders, a work platform, a crane, and other ancillary components.
- **Suction bucket tetrahedron bases:** A suction bucket tetrahedron base foundation is a tetrahedral-shaped (i.e., three-legged pyramidal) frame that rests on the seabed and is secured to the seafloor using suction buckets (see Figure 4.2-3). This foundation design has a maximum of three contact points with the seabed, and a suction bucket is located at each contact point. Like jacket foundations, the tetrahedron base foundation contains a flange for connection to the WTG tower as well as secondary structures (e.g., a boat landing, ladders, a work platform, and a crane).

The Projects' suction bucket foundations may be fabricated either in the U.S. or overseas and will be delivered either directly to the WTA or to a marshalling port for final assembly and staging. If storage at a marshalling port is required, equipment such as crawler cranes or SPMTs will be used to unload and transport foundations within the marshalling port. Depending on the location of fabrication and any subsequent staging activities, foundation components may be transported to the marshalling port or WTA by HTVs, ocean-going barges, jack-up feeder vessels, or smaller feeder barges towed by local tugboats (see Section 4.10.1). Mono-bucket and suction bucket tetrahedron base designs may also enable wet transport (i.e., floating the foundations) to the WTA.

The majority of suction bucket foundations are not expected to require any seabed preparation although seabed preparation may be necessary where the seabed is not sufficiently level. Seabed preparation methods are discussed in Section 4.2.4. Suction bucket foundations may require scour protection (see Section 4.2.5).

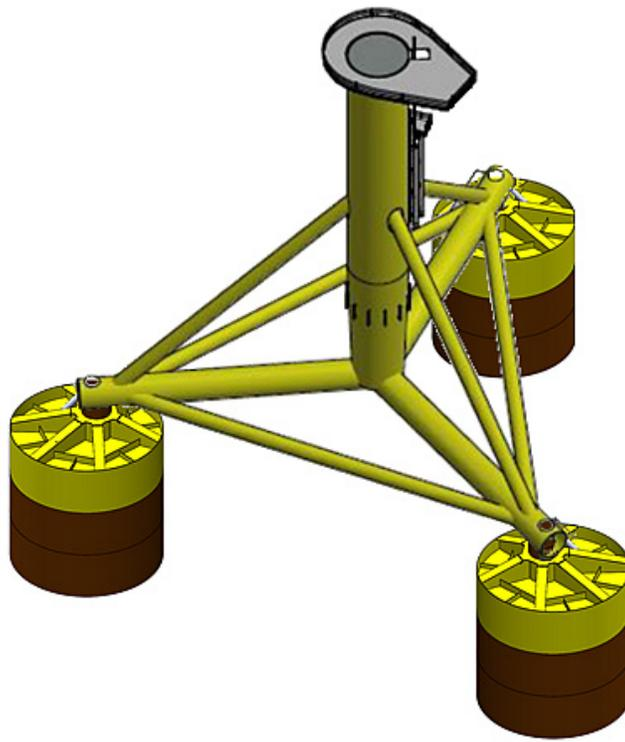

**Suction Bucket Tetrahedron Base**

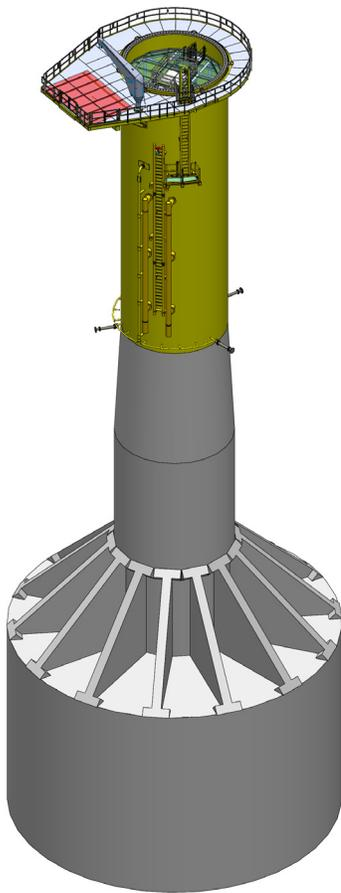

**Mono-Bucket**



**Suction Bucket Jacket**



**Lowering of Suction Bucket Foundation using Jack-Up Vessel Crane**

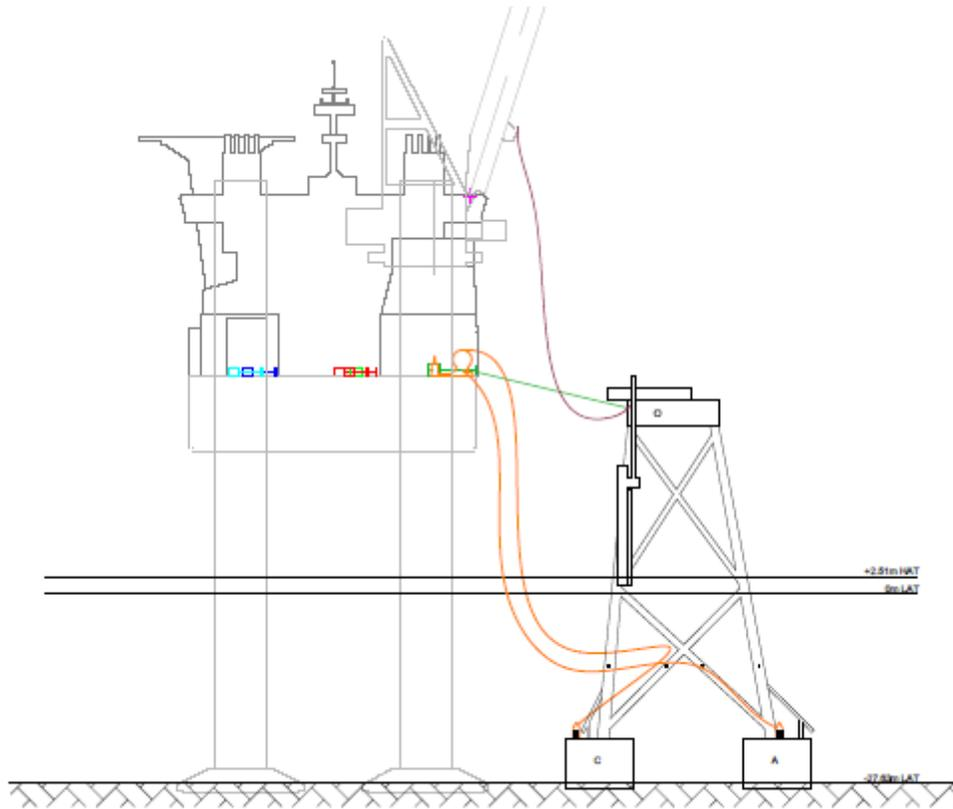

**Embedding Suction Buckets by Pumping Out Water**

Suction bucket foundation installation can be completed with one or two HLVs (using anchoring or DP) or jack-up vessels (see Figure 4.2-4). After a crane lifts the suction bucket foundation from the transport vessel and places it on the seabed (or, for certain suction bucket tetrahedron bases, once the foundation is sunk to the seabed after being floated out to the WTA), the weight of the structure will cause partial penetration of the buckets into the seabed.

After the foundation is in place, the tops of each suction bucket are sealed, and pumps are used to remove water from each bucket to create a negative pressure differential that embeds the bucket into the seabed. Instrumentation within the pump infrastructure will monitor the progress of installation. Real-time monitoring will also ensure the foundation remains vertical, with the pumping speed for each suction bucket controlled individually. The pump will either be pre-installed on top of the suction bucket before it is lowered to the seabed or attached by a remotely-operated vehicle (ROV) after the suction bucket is placed on the seabed. The seawater that is then pumped out of the suction bucket will be discharged at the pump's location. The flow rate of discharged water is relatively low, and no disturbance to the seabed is expected to result from discharge of the water. Once the foundation is fully embedded, the pumps will be removed. The space inside the suction bucket (between the bucket lid and sediment inside the bucket) may be backfilled with a cement grout, if determined necessary.

Suction bucket foundations do not require a hammer or drill for installation. Thus, the process of installing a suction bucket foundation is nearly noise-free and the foundation has the potential to be completely removed upon decommissioning.

The entire installation process for a mono-bucket, including lifting the foundation onto the seabed, self-penetration, pumping out water, retrieving the pumps, and grouting the buckets is expected to take less than approximately 7 to 9 hours per foundation. After a mono-bucket foundation is installed, a transition piece (if separate) may be installed by a vessel's crane and secured with bolts, grout, a slip joint, other mechanical joint, or a combination of these methods. The entire installation process for a suction bucket jacket or suction bucket tetrahedron base foundation should be completed within 15 hours.

The PDE of seabed disturbance for suction bucket foundations is described in Section 4.2.6. Installation activities will always occur within surveyed areas of the WTA.

### 4.2.3 Gravity Foundations

A gravity foundation is stable simply by virtue of its weight and design and requires no piles or suction buckets. Gravity foundations vary in shape and are generally larger at seabed level than piled or suction bucket foundations to provide support and stability for the structure. Two sub-types of gravity foundations are included in the PDE. The PDE for each foundation sub-type is provided in Table 4.2-1 (see Section 4.2.6).

- **Gravity-base structures:** A GBS is a heavy steel-reinforced concrete and/or steel structure that sits on the seabed (see Figure 4.2-5). The GBS foundation's concrete base may be



**Gravity-Base Structures (GBS)**

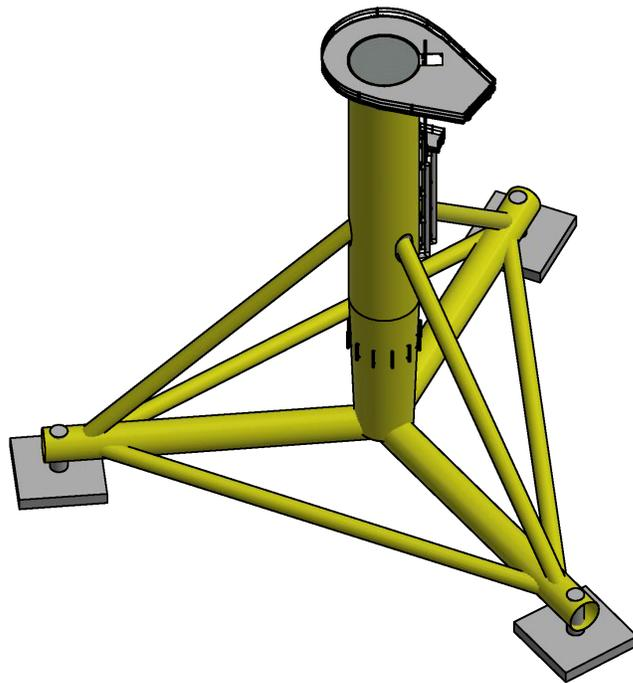

**Gravity-Pad Tetrahedron Base**

filled with additional ballast material. Ballast material for GBS foundations will likely be sourced from the US, Canada, or Europe and will consist of seawater, sand, gravel, or other crushed minerals or stones. As mentioned in Section 4.5.3.2, some portion of the dredged sand from sand bedform removal may also be used for ballast in GBS foundations if those foundations are selected for the Projects. Above the concrete base, there is a column made of concrete or steel that supports the WTG tower. A transition piece may be mounted on top of the GBS foundation (similar to the monopile foundation type described in Section 4.2.1).

- **Gravity-pad tetrahedron bases:** Gravity-pad tetrahedron bases are similar to the suction bucket tetrahedron bases but are secured in place using high weight pads (i.e., gravity pads) below each leg (see Figure 4.2-5). Similar to piled jacket, suction bucket jacket, and suction bucket tetrahedron base foundations, the top of the foundation contains a flange for connection to the WTG tower as well as secondary structures such as a boat landing, ladders, a work platform, a crane, and other ancillary components.

Gravity foundations will be constructed in the U.S. at an onshore location adjacent to a waterway in proximity to the WTA. The gravity foundation may be built entirely onshore or relocated to the adjacent waterway during construction to facilitate subsequent construction activities (see Figure 4.2-6). For example, the vertical foundation sections, transition piece, and secondary components may be installed by quayside cranes while the foundation is temporarily located in the waterway adjacent to the quay. The completed or partially constructed gravity foundation will be transferred to the water through a dry dock, ballasted barge, or other heavy lift methods.

GBS designs may allow for the WTG to be installed on the foundation at port (see Figure 4.2-6). Certain designs make use of a telescoping tower that is retracted within the foundation column until the GBS is installed at the WTA. After the WTG tower is installed onto the foundation, the nacelle and blades will be lifted quayside and attached to the tower section. If the WTG is integrated onto the GBS at the port, a purpose-built installation and transportation aid may be secured to the GBS to stabilize the foundation during the remaining assembly and transport to the WTA (see Figure 4.2-7).

Depending on the construction and installation strategy, once the gravity foundations are totally or partially completed, and in order to release the construction area for subsequent foundation production, the foundations can be temporarily stored onshore or in a designated wet storage area (either adjacent to the quayside or in a designated waterway anchorage area established by the foundation supplier). When a suitable window for installations opens, the units will be refloated and transported to the WTA for installation or to the quayside for remaining assembly activities.

For gravity foundations, seabed preparation in the WTA may be needed prior to installation to ensure full contact between the foundation's base and the seafloor so that the foundation remains vertical, and its weight is uniformly distributed. Seabed preparation may be followed by the installation of a gravel pad. Section 4.2.4 provides more details on seabed preparation for gravity foundations. Gravity foundations may also require scour protection (see Section 4.2.5).



**WTG Installation onto a Gravity Foundation in Port**



**Gravity Foundation Transport via Tugboats**

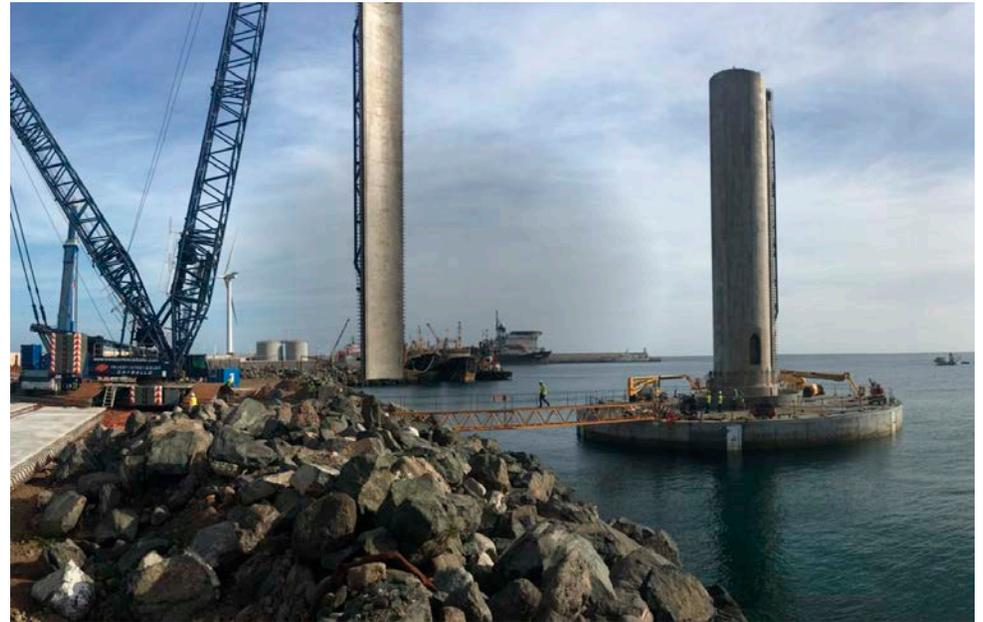

**Gravity Foundation Construction in Port**





Gravity foundations could either be transported to the WTA onboard a large-capacity barge or floated to the WTA using multiple tugboats. If transported to the WTA onboard a large-capacity barge, an HLV's crane will lift the foundation and place it on the seabed. If floated to the WTA, the foundation may be transported by tugboats directly to the WTA from the supplier's fabrication location or the foundation may first be transported by the supplier on a semisubmersible barge to a sheltered offshore location before being lowered into the water, connected to tugboats, and pulled to the WTA. When the floating foundation arrives at the WTA, the foundation will be lowered to the seabed by increasing ballast. Once the foundation is at its final position on the seabed, the tugboats are disconnected, and the purpose-built installation and transportation aid (if used) is removed.

After the foundation is in place on the seabed, any additional ballast material (if needed) will be pumped into the foundation's interior by a dedicated vessel to provide additional stability. For concepts that do not involve quayside installation of the transition piece or WTG, the transition piece and WTG will then be installed. If a telescoping gravity foundation design is employed, the telescopic portion of the foundation is jacked up by lifting equipment arranged around the foundation's service platform. After the telescopic portion of the foundation is fully extended and secured, the lifting equipment is removed from the structure.

With a single installation spread, it is anticipated that one gravity foundation will be installed per day. The PDE of seabed disturbance for gravity foundation installation is described in Table 4.2-1.

#### 4.2.4 Seabed Preparation

In general, foundations will be positioned or sized to avoid or reduce seabed preparation where possible.

As described in Sections 4.2.1 through 4.2.3, foundations, particularly gravity foundations, may require some seabed preparation. Seabed preparation involves removing the uppermost sediment layer to establish a level surface, remove any surficial sediments that are too weak to support the planned structure, and enable full contact between the foundation's base and the seafloor. This is necessary to ensure that the foundation remains vertical, and its weight is uniformly distributed. For gravity foundations it may take three to four days to prepare the seabed prior to installation.

Piled and suction bucket foundations are not expected to require seabed preparation unless the seabed is not sufficiently level (e.g., where large sand bedforms are present). Where this occurs, the seabed may need to be prepared prior to pile-driving or suction bucket installation. The maximum dimensions of seabed preparation that could be required for each foundation type is provided in Table 4.2-1.

Seabed preparation could be accomplished using:

- **Trailing suction hopper dredge (TSHD):** TSHD uses suction pipes to collect sediment in the hopper of the vessel, thus leveling the seabed (see Section 4.5.3.2 for additional details).
- **Jetting/controlled flow excavation:** This method involves directing columns of water at the seabed to excavate sediments and push them aside (see Section 4.5.3.2 for additional details).
- **A backhoe/dipper:** A backhoe/dipper is a mechanical method of removing high points on the seabed to level the sediments in preparation for foundation installation.

For gravity foundations, a gravel pad may be installed after completing seabed preparation. The gravel pad is expected to consist of one or more layer(s) of coarse-grained material. The gravel pads may be comprised of a filter layer (i.e., a layer of finer material) and an armor layer (i.e., a layer of coarser material). Installation of the gravel pad typically consists of the following steps:

1. lowering of a steel frame, if needed, to set the boundaries for the gravel pad;
2. leveling the surface of the area within the steel frame;
3. filling the volume inside the steel frame with coarse-grained material;
4. levelling the gravel pad; and
5. compacting the gravel pad and possibly injecting the pad with grout.

Seabed preparation and installation of the gravel pad will likely be performed by a DP fallpipe vessel.

#### 4.2.5 Scour Protection

Scour protection may be installed at the base of each foundation to protect it from sediment transport/erosion caused by water currents. The presence of foundations can create locally higher currents around the structures, which scour protection can withstand.

The PDE includes six types of scour protection:

1. **Rock placement:** up to three layers of rock, with the lower layer(s) consisting of smaller rock and the upper armor layer consisting of larger rock;
2. **Rock bags:** a rock-filled filter unit enclosed by polyester mesh that is non-corrosive, rot-proof, and weather-resistant with proven 30-year durability;
3. **Grout- or sand-filled bags:** bags filled with grout or sand and lowered into place by the installation vessel cranes;
4. **Concrete mattresses:** high-strength concrete blocks cast around a mesh (e.g., ultra-violet stabilized polypropylene rope) that holds the blocks in a flexible covering;

5. **Ballast-filled mattresses:** a folded mattress filled with ballast material (i.e., a sand/water/bentonite mixture or similar) that is lowered to the seabed and unfolded at the base of the foundation; and/or
6. **FronD mattresses:** buoyant fronds approximately 3 ft (1 m) high, which are designed to replicate how natural seaweed reduces water velocity locally, are densely built into a mattress, and are deployed either directly onto the seabed or attached to the structure.

Scour protection consisting of freely-laid rock will likely be installed by a fallpipe vessel, which uses a pipe that extends to just above the seafloor to deposit rock contained in the vessel's hopper in a controlled manner. Concrete mattresses, rock bags, grout- or sand-filled bags, and frond mattresses will likely be deployed by a vessel's crane.

All scour protection options considered for the Projects were screened for technical and economic suitability. The need for and selected type(s) of scour protection will be determined by the final design of the foundations and ongoing agency consultations. The PDE of scour protection dimensions for each foundation type under consideration is defined in Table 4.2-1. Scour protection may occur in any shape and size up to the maximum footprint provided in Table 4.2-1, including the possibility of no scour protection.

#### 4.2.6 Project Design Envelope for the WTG Foundations

The PDE of WTG foundation parameters is provided in Table 4.2-1 below.

Table 4.2-1 PDE of WTG Foundations Dimensions and Seabed Disturbance

Concept	Piled		Suction Bucket			Gravity	
	Monopile	Piled Jacket	Mono-Bucket	Suction Bucket Jacket	Suction Bucket Tetrahedron Base	Gravity-Pad Tetrahedron Base	GBS
<b>Foundation Structure</b>							
Max. pile, suction bucket, gravity-base, or gravity-pad diameter at seabed	49.2 ft (15.0 m)	16.4 ft (5.0 m)	114.8 ft (35.0 m)	49.2 ft (15.0 m)	52.5 ft (16.0 m)	36.1 ft x 36.1 ft (11.0 m x 11.0 m)	180.5 ft (55.0 m)
Max. # of legs/discrete contact points with seabed	1	4	1	4	3	3	1
Max. depth of penetration below seabed	With scour protection: 196.9 ft (60.0 m) Without: 262.5 ft (80.0 m)	229.7 ft (70.0 m)	114.8 ft (35.0 m)	65.6 ft (20.0 m)	65.6 ft (20.0 m)	9.8 ft (3.0 m)	9.8 ft (3.0 m)
Monopile/jacket pile/bucket length	With scour protection: 344.5 ft (105.0 m) Without: 410.1 ft (125.0 m)	249.3 ft (76.0 m)	147.6 ft (45.0 m)	82.0 ft (25.0 m)	82.0 ft (25.0 m)	N/A	N/A
Max. distance between adjacent legs at seabed	N/A	131.2 ft (40.0 m)	N/A	131.2 ft (40.0 m)	131.2 ft (40.0 m)	246.1 ft (75.0 m)	N/A
Max. foundation diameter/leg spacing at Mean Sea Level (MSL)	39.4 ft (12.0 m)	98.4 ft (30.0 m)	39.4 ft (12.0 m)	98.4 ft (30.0 m)	39.4 ft (12.0 m)	39.4 ft (12.0 m)	39.4 ft (12.0 m)
Max. total foundation footprint contacting seabed per foundation <sup>a</sup>	1,902.0 square feet (ft <sup>2</sup> ) (176.7 square meters [m <sup>2</sup> ])	845.0 ft <sup>2</sup> (78.5 m <sup>2</sup> )	10,356.0 ft <sup>2</sup> (962.1 m <sup>2</sup> )	7,609.0 ft <sup>2</sup> (706.9 m <sup>2</sup> )	6,492.8 ft <sup>2</sup> (603.2 m <sup>2</sup> )	3,907.3 ft <sup>2</sup> (363.0 m <sup>2</sup> )	25,572.9 ft <sup>2</sup> (2,375.8 m <sup>2</sup> )
<b>Seabed Disturbance</b>							
<b>Permanent Seabed Disturbance</b>							
Max. representative <sup>b</sup> outer diameter/size of scour protection	269.0 ft (82.0 m) per foundation	98.4 ft (30.0 m) per leg	295.3 ft (90.0 m) per foundation	334.6 ft x 334.6 ft (102.0 m x 102.0 m) per foundation	347.8 ft x 328.1 ft (106.0 m x 100.0 m) per foundation	98.4 ft x 98.4 ft (30.0 m x 30.0 m) per leg	272.3 ft (83.0 m) per foundation
Max. thickness of scour protection	8.2 ft (2.5 m)	6.6 ft (2.0 m)	6.6 ft (2.0 m)	6.6 ft (2.0 m)	6.6 ft (2.0 m)	4.9 ft (1.5 m)	4.6 ft (1.4 m)
Est. volume of scour protection per foundation	314,300.5 ft <sup>3</sup> (8,900.0 m <sup>3</sup> )	125,720.2 ft <sup>3</sup> (3,560.0 m <sup>3</sup> )	413,181.6 ft <sup>3</sup> (11,700.0 m <sup>3</sup> )	600,543.6 ft <sup>3</sup> (17,005.5 m <sup>3</sup> )	461,477.9 ft <sup>3</sup> (13,067.6 m <sup>3</sup> )	123,795.6 ft <sup>3</sup> (3,505.5 m <sup>3</sup> )	151,786.0 ft <sup>3</sup> (4,298.1 m <sup>3</sup> )
<b>Max. total permanent footprint per foundation (foundation + scour protection + mud mats [post-piled jackets only])</b>	<b>56,844.3 ft<sup>2</sup> (5,281.0 m<sup>2</sup>)</b>	<b>30,434.2 ft<sup>2</sup> (2,827.4 m<sup>2</sup>)</b>	<b>111,987.6ft<sup>2</sup> (6,361.7 m<sup>2</sup>)</b>	<b>111,987.6 ft<sup>2</sup> (10,404.0 m<sup>2</sup>)</b>	<b>92,870.9 ft<sup>2</sup> (8,628.0 m<sup>2</sup>)</b>	<b>29,062.6 ft<sup>2</sup> (2,700.0 m<sup>2</sup>)</b>	<b>58,239.2 ft<sup>2</sup> (5,410.6 m<sup>2</sup>)</b>

Table 4.2-1 PDE of WTG Foundations Dimensions and Seabed Disturbance (Continued)

Concept	Piled		Suction Bucket			Gravity	
	Monopile	Piled Jacket	Mono-Bucket	Suction Bucket Jacket	Suction Bucket Tetrahedron Base	Gravity-Pad Tetrahedron Base	GBS
<b>Seabed Disturbance</b>							
<b>Temporary Seabed Disturbance During Construction</b>							
Max. dimensions of seabed preparation per foundation	269.0 ft x 269.0 ft (82.0 m x 82.0 m)	229.7 ft x 229.7 ft (70.0 m x 70.0 m)	295.3 ft x 295.3 ft (90.0 m x 90.0 m)	334.6 ft x 334.6 ft (102.0 m x 102.0 m)	347.8 ft x 328.1 ft (106.0 m x 100.0 m)	311.7 ft x 344.5 ft (95.0 m x 105.0 m)	272.3 ft x 272.3 ft (83.0 m x 83.0 m)
Max. depth seabed preparation <sup>c</sup>	19.7 ft (6.0 m)	19.7 ft (6.0 m)	19.7 ft (6.0 m)	19.7 ft (6.0 m)	19.7 ft (6.0 m)	19.7 ft (6.0 m)	19.7 ft (6.0 m)
Max. area of seabed preparation per foundation	72,376.5 ft <sup>2</sup> (6,724.0 m <sup>2</sup> )	52,743.2 ft <sup>2</sup> (4,900.0 m <sup>2</sup> )	87,187.7 ft <sup>2</sup> (8,100.0 m <sup>2</sup> )	111,987.6 ft <sup>2</sup> (10,404.0 m <sup>2</sup> )	92,871.0 ft <sup>2</sup> (8,628.0 m <sup>2</sup> )	81,133.0 ft <sup>2</sup> (7,537.5 m <sup>2</sup> )	74,152.6 ft <sup>2</sup> (6,889.0 m <sup>2</sup> )
Avg. volume of seabed preparation per foundation <sup>d</sup>	125,258.1 ft <sup>3</sup> (3,546.9 m <sup>3</sup> )	91,279.7 ft <sup>3</sup> (2,584.8 m <sup>3</sup> )	150,890.9 ft <sup>3</sup> (4,272.8 m <sup>3</sup> )	193,811.0 ft <sup>3</sup> (5,488.1 m <sup>3</sup> )	160,726.7 ft <sup>3</sup> (4,551.3 m <sup>3</sup> )	133,436.1 ft <sup>3</sup> (3,778.5 m <sup>3</sup> )	128,331.9 ft <sup>3</sup> (3,634.0 m <sup>3</sup> )
Max. disturbance due to jack-up or anchored vessels per foundation <sup>e</sup>	58,125.1 ft <sup>2</sup> (5,400.0 m <sup>2</sup> )	47,361.2 ft <sup>2</sup> (4,400.0 m <sup>2</sup> )	58,125.1 ft <sup>2</sup> (5,400.0 m <sup>2</sup> )	47,361.2 ft <sup>2</sup> (4,400.0 m <sup>2</sup> )	47,361.2 ft <sup>2</sup> (4,400.0 m <sup>2</sup> )	0.0 ft <sup>2</sup> (0.0 m <sup>2</sup> )	10,763.9 ft <sup>2</sup> (1,000.0 m <sup>2</sup> )
<b>Max. total temporary seabed disturbance beyond permanent footprint per foundation</b>	<b>73,657.2 ft<sup>2</sup> (6,843.0 m<sup>2</sup>)</b>	<b>69,670.1 ft<sup>2</sup> (6,472.6 m<sup>2</sup>)</b>	<b>76,835.7 ft<sup>2</sup> (7,138.3 m<sup>2</sup>)</b>	<b>47,361.2 ft<sup>2</sup> (4,400.0 m<sup>2</sup>)</b>	<b>47,361.2 ft<sup>2</sup> (4,400.0 m<sup>2</sup>)</b>	<b>52,070.4 ft<sup>2</sup> (4,837.5 m<sup>2</sup>)</b>	<b>26,677.2ft<sup>2</sup> (2,478.4 m<sup>2</sup>)</b>
<b>Total Temporary and Permanent Seabed Disturbance During Construction</b>							
<b>Max. total area of seabed disturbance per foundation</b>	<b>130,501.5 ft<sup>2</sup> (12,124.0 m<sup>2</sup>)</b>	<b>100,104.3 ft<sup>2</sup> (9,300.0 m<sup>2</sup>)</b>	<b>145,312.4 ft<sup>2</sup> (13,500.0 m<sup>2</sup>)</b>	<b>159,348.8 ft<sup>2</sup> (14,804.0 m<sup>2</sup>)</b>	<b>140,232.1 ft<sup>2</sup> (13,028.0 m<sup>2</sup>)</b>	<b>81,132.9 ft<sup>2</sup> (7,537.5 m<sup>2</sup>)</b>	<b>84,916.4 ft<sup>2</sup> (7,889.0 m<sup>2</sup>)</b>
<b>Installation Timeframe</b>							
Approx. max. duration to drive one pile	7-9 hours	3-4 hours	N/A	N/A	N/A	N/A	N/A
Max. # of piles driven per day	2	4	N/A	N/A	N/A	N/A	N/A

- Notes:
- a) The footprint of any mud mats (if used) would overlap with the footprint of scour protection and are included in the "Max. total permanent footprint" rather than the "Total foundation footprint contacting seabed."
  - b) Scour protection may occur in any shape and size up to the maximum footprint provided, including the possibility of no scour protection.
  - c) In the worst-case situation, in a limited number of foundation positions, up to 19.7 ft (6 m) of seabed leveling could be required. Piled and suction bucket foundations are not expected to require seabed preparation unless the seabed is not sufficiently level).
  - d) The maximum total volume of seabed preparation for the WTG foundations will not exceed the average volume for an individual foundation multiplied by 200 foundations.
  - e) Foundation installation using jack-up vessels is expected to involve one main installation jack-up vessel with a maximum disturbance of 10,763.9 ft<sup>2</sup> (1,000.0 m<sup>2</sup>) (four legs, each disturbing 2,691.0 ft<sup>2</sup> [250.0 m<sup>2</sup>]) and one feeder-jack-up vessel with a maximum disturbance of 4,869.5 m<sup>2</sup> (452.4 m<sup>2</sup>) (four legs, each disturbing 1,217.4 ft<sup>2</sup> [113.1 m<sup>2</sup>]) at each position. Although less likely, if an anchored HLV is used, foundation installation is expected to involve one anchored HLV with a maximum disturbance of 47,361.2 ft<sup>2</sup> (4,400 m<sup>2</sup>) (four anchors, each with a disturbance of 1,076.4 ft<sup>2</sup> [100.0 m<sup>2</sup>] for the anchor itself plus 10,763.9 ft<sup>2</sup> [1,000.0 m<sup>2</sup>] for the mooring system) at each position; the feeder barge(s) would moor to the HLV and cause no additional disturbance. If transition pieces are installed in a separate campaign, another jack-up vessel with a maximum disturbance of 10,763.9 ft<sup>2</sup> (1,000.0 m<sup>2</sup>) may be used. The scenario resulting in the greatest seafloor disturbance for each foundation type is assumed in the table above. Additional emergency anchoring or jacking-up may be required.

## 4.3 Wind Turbine Generators

### 4.3.1 WTG Design

The Projects' WTGs are expected to follow the traditional offshore WTG design comprised of a three-bladed rotor nacelle assembly (RNA) mounted on a tower structure affixed to a foundation. The rotor will drive a variable speed electric generator. Depending on the model of WTG selected, the drivetrain may include a gearbox to increase the rotational speed of the generator. The WTG will sense the direction of the wind using integrated sensors and will automatically turn into the wind by activating the yaw system. The WTG will also adjust the blades continuously during operation to maximize power production and maintain safe operating limits. The drivetrain, electric generator, yaw system, control system, and power electronics are enclosed in a nacelle, which provides protection from the weather as well as lightning protection.

The WTG power system (i.e., the power converter, transformers, and switchgear) converts the voltage and frequency of the power produced by the WTG's generator to the inter-array cables' voltage (66 to 150 kilovolts [kV]) and electrical grid's frequency, reduces harmonics, and provides reactive power control. The power converter and transformer may be located in the nacelle or inside the WTG tower. The switchgear and inter-array cable terminations may be located inside the WTG tower or inside the top of the WTG foundation. All power system components are protected according to best practices and industry standards.

The WTG control and protection system monitors environmental and operational parameters to keep equipment within design limits. Heating and cooling systems regulate the temperature of each component and lubrication systems keep components corrosion-free and rotating smoothly. The control and protection system monitors the WTG and protects equipment and personnel by providing automatic shutdown and alarms. The system also includes fire detection, overheating, overpower, and overspeed protection.

All WTGs in the Projects will be connected to the central supervisory control and data acquisition (SCADA) system for remote monitoring and control (discussed in greater detail in Section 5.1). The SCADA system allows remote operators to track the operation and performance of all Project assets from a single system, to store long-term data, and to access short-term high-resolution data for fault troubleshooting. It also allows functions such as remote testing, software updates, parameter updates, and WTG shut down for maintenance or at the request of grid operators, regulators, or search and rescue (SAR) teams. Individual WTGs can be controlled manually from within the nacelle or tower base for commissioning and maintenance activities.

The WTG can be accessed for commissioning and maintenance from the platform on the WTG foundation via a locked door in the tower base. WTGs are equipped with an elevator, ladders, and other access routes that enable the movement of maintenance personnel, small equipment, and small spare parts inside the tower and RNA. A helihoist platform on top of the nacelle can be used for technician access and for evacuation. To facilitate maintenance, the WTGs will be equipped with auxiliary cranes in the nacelle and on the external working platform.

An uninterruptible power supply (UPS) will power the control and protection system in case of a grid outage to enable safe shut down of the WTG and saving operational data. Additional back-up power systems (e.g., WTG self-power feature, portable generators, and/or battery systems) may be utilized to provide power for commissioning or for storm protection in the event of a longer-term grid outage.

All WTG components will be designed to comply with relevant health, safety, security, and environmental protection (HSSE) standards and regulations. During construction and operation, the WTGs (and their foundations) will be lit and marked in accordance with Federal Aviation Administration (FAA), USCG, and BOEM guidelines to aid safe navigation within the WTA. Lighting and marking of the WTGs during the operations period is discussed in Section 5.3.

The PDE of WTG dimensions is provided in Table 4.3-1 and illustrated in Figure 4.3-1. The WTG dimensions are indicative of the maximum dimensions of WTGs anticipated to be commercially available within the Projects’ expected development schedule (see Section 3.5). The PDE of WTG dimensions provides Atlantic Shores with flexibility in WTG choice, which is necessary to ensure that anticipated advancements in available WTG technology can be incorporated into the Projects’ final design.

Table 4.3-1 PDE of WTG Dimensions

WTG Dimension		Input
Max. Rotor Diameter		918.6 ft (280.0 m)
Max. Tip Height	Relative to MLLW	1,048.8 ft (319.7 m)
	Relative to MSL	1,046.6 ft (319.0 m)
	Relative to HAT	1,043.0 ft (317.9 m)
Max. Top of Nacelle Height	Relative to MLLW	605.9 ft (184.7 m)
	Relative to MSL	603.7 ft (184.0 m)
	Relative to HAT	600.1 ft (182.9 m)
Max. Hub Height	Relative to MLLW	576.4 ft (175.7 m)
	Relative to MSL	574.2 ft (175.0 m)
	Relative to HAT	570.5 ft (173.9 m)
Min. Tip Clearance (air gap)	Relative to MLLW	78.0 ft (23.8 m)
	Relative to MSL	75.8 ft (23.1 m)
	Relative to HAT	72.2 ft (22.0 m)

Table 4.3-1 PDE of WTG Dimensions (Continued)

WTG Dimension	Input
Max. Nacelle Dimensions (length x width x height)	82.0 ft x 52.5 ft x 39.4 ft (25.0 m x 16.0 m x 12.0 m)
Max. Blade Length	452.8 ft (138.0 m)
Max. Blade Chord	32.8 ft (10.0 m)
Max. Tower Diameter	<div style="display: flex; justify-content: space-between;"> <div style="width: 40%;">Top</div> <div>27.9 ft (8.5 m)</div> </div> <div style="display: flex; justify-content: space-between;"> <div style="width: 40%;">Bottom</div> <div>32.8 ft (10.0 m)</div> </div>

Notes: MLLW = Mean Lower Low Water; MSL = Mean Sea Level; HAT = Highest Astronomical Tide

The WTGs will be designed according to site-specific conditions, including winter storms, hurricanes, and tropical storms, based on industry standards such as American Clean Power Association (ACP), International Electrotechnical Commission (IEC), American Petroleum Institute (API), and International Organization for Standardization (ISO) standards. These site conditions and standards will be detailed in the design basis and verified by the independent CVA as part of the Facility Design Report (FDR) and the Fabrication and Installation Report (FIR). The WTG design is suitable for offshore wind sites with reference wind speeds of 111.8 to 127.5 miles per hour (mph) (50 to 57 meters per second [m/s]) over a 10-minute average and 50-year extreme gusts of 156.6 to 178.5 mph (70 to 79.8 m/s) over a 3-second average for type certification.<sup>19</sup> A site-specific assessment of the WTGs will be performed for the Projects. The WTGs are expected to produce power at wind speeds between approximately 9.8 and 101 feet per second (ft/s) (3 and 31 m/s), although the WTGs' exact environmental operating conditions will depend on vendor and WTG model. WTGs will automatically shut down in wind speeds above the WTGs' maximum operational limit.

#### 4.3.2 WTG Installation

WTG components are expected to be manufactured in the U.S. or overseas and shipped, if needed, to a U.S. marshalling port. At the marshalling port, WTG components will be offloaded, stored, pre-assembled, and prepared for load-out. The WTG components (i.e., blades, nacelles, and towers) will be delivered in suitable transport and lifting frames to facilitate loading, offloading, storage, and installation. The components will be offloaded using shore-based equipment (e.g., cranes and SPMTs) and will be inspected for damage before being transported from quayside to storage. Storage will ensure a constant supply of WTGs to the assembly location or the WTA.

<sup>19</sup> Type certificates are issued by an accredited certification body to independently verify that a WTG (or other renewable energy equipment) is designed and manufactured in accordance with all applicable requirements/standards.



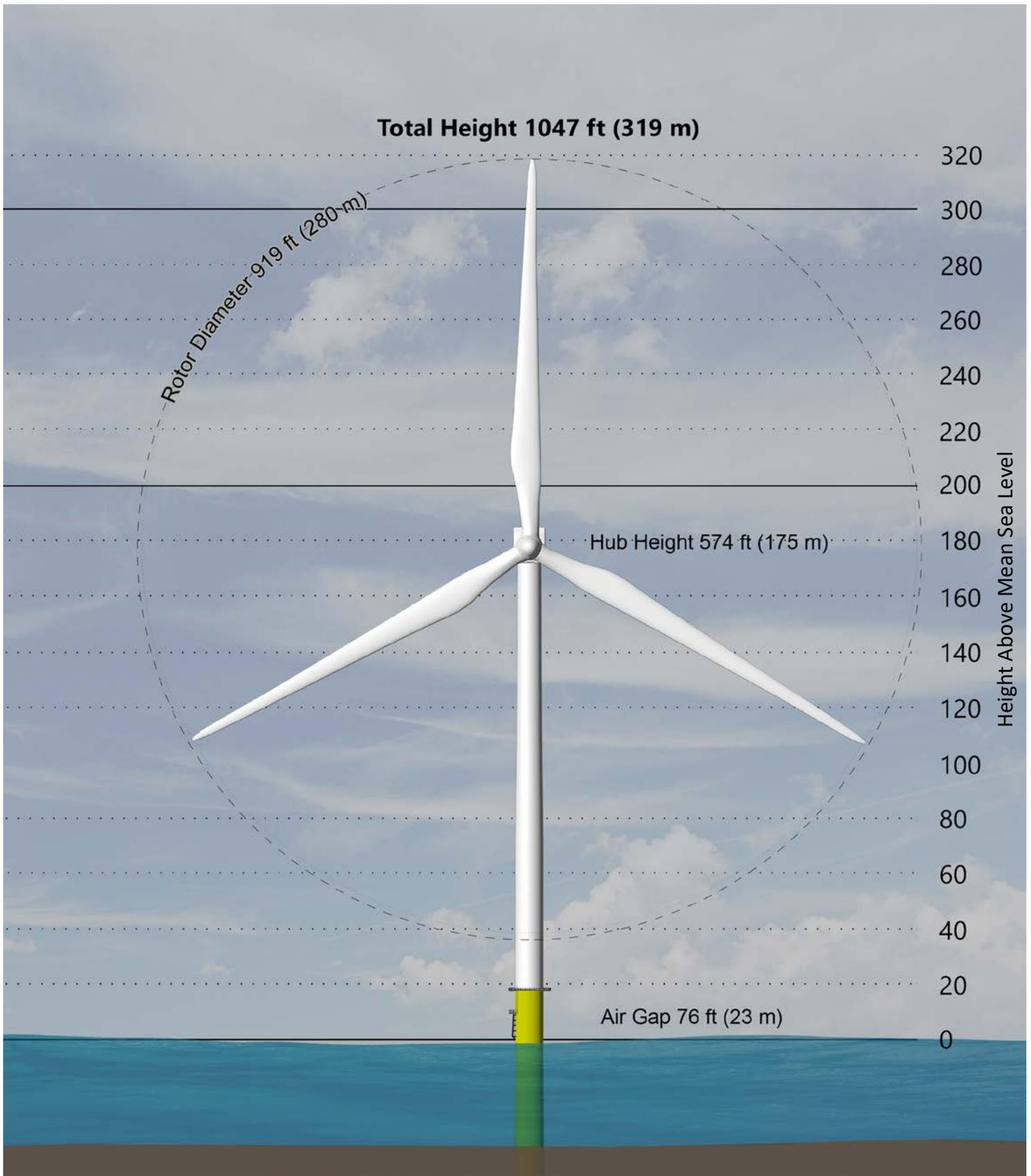

The WTG components may be pre-assembled at the marshaling port. Pre-assembly of WTG tower sections may include assembling the complete or partial tower structure (assuming the port does not have an air draft restriction). To complete this operation, a heavy-lift crane lifts the bottom tower section into a vertical position, and the tower section is secured to a temporary foundation near the quayside. Remaining tower sections are then stacked on top and secured, after which internal elements are installed and may be pre-commissioned. Towers are inspected prior to loading onto vessels for installation. Pre-assembly of the nacelle may include mounting of minor equipment and external structures. Prior to load-out, the nacelle is inspected. Blades are typically transported and stored in racks and minimal pre-assembly is required.

Offshore installation of WTGs is expected to involve a jack-up WTG installation vessel assisted by feeder barges or jack-up feeder vessels. The jack-up WTG installation vessel will be equipped with a crane to lift WTG components from the feeder barges/vessel onto the foundation (see Figure 4.3-2). Seafloor impacts from jack-up vessels used during WTG installation are provided in Table 4.3-2.

As described in Section 4.2.3, gravity foundations could enable full assembly of the WTG onto the foundation at port with subsequent towing to the WTA. With this approach, the gravity foundation is placed on a semisubmersible barge or temporarily set on the bottom at quayside. A shore-based crane lifts the tower sections onto the foundation where they are secured. Towers are inspected prior to assembly. The RNA is then assembled onto the top tower section, after which blades are assembled onto the hub. The entire assembly is then towed to a wet storage location or to the WTA for installation.

Table 4.3-2 Maximum Seabed Disturbance from WTG Installation

Installation Activity	PDE
Max. area of seafloor disturbance per jack-up WTG installation vessel	10,763.9 ft <sup>2</sup> (1000.0 m <sup>2</sup> ) (four legs, each disturbing 2,691.0 ft <sup>2</sup> [250.0 m <sup>2</sup> ])
Max. area of seafloor disturbance per jack-up feeder vessel	4,869.5 ft <sup>2</sup> (452.4 m <sup>2</sup> ) (four legs, each disturbing 1,217.4 ft <sup>2</sup> [113.1 m <sup>2</sup> ])
Max. # of times vessels jack-up per WTG	1 time for the jack-up WTG installation vessel & 1 time for the jack-up feeder vessel
<b>Max. area of seafloor disturbance from jack-ups per WTG</b>	<b>15,633.4 ft<sup>2</sup> (1,452.4 m<sup>2</sup>)</b>

### 4.3.3 WTG Commissioning

Following installation, the WTGs will be energized from the grid through the inter-array cables or with a temporary power supply. Then, the commissioning process will prepare WTGs for operation. The purpose of commissioning is to test electrical connections, safety and control functions of the



**Transport of WTG Components via Jack-Up Vessel**



**Installation of WTG Component using Jack-Up Vessel Crane**

WTG (e.g., emergency stop, auto restart, etc.), and the communication between the WTG and the SCADA system. It is likely that installed WTGs will undergo commissioning and testing while other WTGs are still being installed. Once commissioning is completed, a test run (i.e., trial operation) is carried out (typically for 240 hours) to demonstrate that the WTG performs as expected and is reliable. During commissioning and testing, personnel may be transported to and from WTGs via service operation vessels (SOVs), crew transfer vessels (CTVs), and/or helicopters.

## 4.4 Offshore Substations

The Projects will include one or more OSSs that serve as common collection points for power from the WTGs and also serve as the origin for the export cables that deliver power to shore. Atlantic Shores is considering three sizes of OSS. Depending on the final OSS design, there will be up to 10 small OSSs, up to five medium OSSs, or up to four large OSSs in the Projects combined. There will be up to five small OSSs, two medium OSSs, or two large OSSs for Project 1; and up to five small OSSs, three medium OSSs, or two large OSSs for Project 2.

OSSs will be located along the same east-northeast to west-southwest rows as the WTGs; small OSSs will be located no closer than 12 miles (mi) (19.3 km) from shore whereas medium and large OSSs will be located at least 13.5 mi (21.7 km) from shore. Potential OSS locations for both Projects are shown on Figure 3.1-2 and the OSS layout is described further in Section 3.1. OSS foundations are described in Section 4.4.1, while topside structures are described in Section 4.4.2. Scour protection, which may be installed around OSS foundations, and seabed preparation are described in Section 4.4.3.

### 4.4.1 OSS Foundation Design and Installation

Similar to the WTG foundations, the PDE includes three categories of OSS foundations that may be affixed to the seabed using piles, suction buckets, or gravity. The type of OSS foundation used depends on the size of the OSS itself (see Table 4.4-1).

Table 4.4-1 OSS Foundation Types

Foundation Types		Small OSS	Medium OSS	Large OSS
Piled	Monopile	•		
	Piled Jacket	•	•	•
Suction Bucket	Mono-Bucket	•		
	Suction Bucket Jacket	•	•	•
Gravity	GBS	•	•	•

These foundation types are similar to those under consideration for the WTGs, although tetrahedron base foundations are not included in the OSS foundation PDE. Each foundation type and the various foundation installation methods are described in Section 4.2. For the OSSs, the GBS foundations includes a multi-leg option as shown in Figure 4.4-1.

There could be up to 10 small OSSs. For these OSS, the PDE for each foundation type is identical to the PDE for the WTG foundations provided in Table 4.2-1. The PDE of foundation dimensions for the medium and large OSSs is defined in Table 4.4-2.



Table 4.4-2 PDE of OSS Foundation Dimensions and Seabed Disturbance

Foundation Concept	Medium OSS			Large OSS		
	Piled Jacket	Suction Bucket Jacket	GBS	Piled Jacket	Suction Bucket Jacket	GBS
<b>Foundation Structure</b>						
Max. # of foundations	5	5	5	4	4	4
Max. pile, suction bucket, or gravity-base diameter at seabed	Pile diameter: 16.4 ft (5.0 m) Including piling template: 49.2 ft (15.0 m)	49.2 ft (15.0 m)	262.5 x 65.6 ft (80.0 m x 20.0 m)	Pile diameter: 16.4 ft (5.0 m) Including piling template: 65.6 ft (20.0 m)	49.2 ft (15.0 m)	393.7 ft x 98.4 ft (120.0 x 30.0 m)
Max. # of legs/discrete contact points with seabed	6 legs (up to two pin piles per leg)	6	2	8 legs (up to 3 pin piles per leg)	8	2
Max. depth of penetration below seabed	229.7 ft (70.0 m)	82.0 ft (25.0 m)	9.8 ft (3.0 m)	229.7 ft (70.0 m)	82.0 ft (25.0 m)	9.8 ft (3.0 m)
Max. jacket pile/bucket length	295.3 ft (90.0 m)	98.4 ft (30.0 m)	N/A	295.3 ft (90.0 m)	98.4 ft (30.0 m)	N/A
Max. distance between adjacent legs at seabed	196.9 ft (60.0 m)	196.9 ft (60.0 m)	180.4 ft (55.0 m)	164.0 ft (50.0 m)	164.0 ft (50.0 m)	229.7 ft (70.0 m)
Max. foundation size/leg spacing at MSL	393.7 ft x 196.9 ft (120.0 m x 60.0 m)	393.7 ft x 196.9 ft (120.0 m x 60.0 m)	262.5 ft x 246.1 ft (80.0 m x 75.0 m)	492.1 ft x 328.1 ft (150.0 x 100.0 m)	492.1 ft x 328.1 ft (150.0 m x 100.0 m)	393.7 ft x 328.1 ft (120.0 m x 100.0 m)
Max. total foundation footprint contacting seabed per foundation <sup>a</sup>	11,413.0 ft <sup>2</sup> (1,060.3 m <sup>2</sup> )	11,413.0 ft <sup>2</sup> (1,060.3 m <sup>2</sup> )	34,444.5 ft <sup>2</sup> (3,200.0 m <sup>2</sup> )	27,052.9 ft <sup>2</sup> (2,513.3 m <sup>2</sup> )	15,216.9 ft <sup>2</sup> (1,413.7 m <sup>2</sup> )	77,500.2 ft <sup>2</sup> (7,200.0 m <sup>2</sup> )
<b>Seabed Disturbance</b>						
<b>Permanent Seabed Disturbance</b>						
Max. representative <sup>b</sup> outer diameter/size of scour protection	131.2 ft (40.0 m) per leg	196.9 ft (60.0 m) per leg	393.7 ft x 377.3 ft (120.0 m x 115.0 m) per foundation	147.6 ft (45.0 m) per leg	695.5 ft x 203.4 ft (212.0 m x 62.0 m) per row of four legs	524.9 ft x 459.3 ft (160.0 m x 140.0 m) per foundation
Max. thickness of scour protection	6.6 ft (2.0 m)	6.6 ft (2.0 m)	5 ft (1.5 m)	6.6 ft (2.0 m)	6.6 ft (2.0 m)	5 ft (1.5 m)
Est. volume of scour protection per foundation	380,427.2 ft <sup>3</sup> (10,772.5 m <sup>3</sup> )	885,903.7 ft <sup>3</sup> (25,086.0 m <sup>3</sup> )	731,013.6 ft <sup>3</sup> (20,700.0 m <sup>3</sup> )	666,998.7 ft <sup>3</sup> (18,887.3 m <sup>3</sup> )	1,485,370.2 ft <sup>3</sup> (42,061.0 m <sup>3</sup> )	1,186,572.8 ft <sup>3</sup> (33,600.0 m <sup>3</sup> )
<b>Max. total permanent footprint per foundation (foundation + scour protection + mud mats [post-piled jackets only])</b>	<b>81,157.9 ft<sup>2</sup> (7,539.8 m<sup>2</sup>)</b>	<b>182,605.3 ft<sup>2</sup> (16,964.6 m<sup>2</sup>)</b>	<b>148,541.8 ft<sup>2</sup> (13,800.0 m<sup>2</sup>)</b>	<b>136,953.9 ft<sup>2</sup> (12,723.5 m<sup>2</sup>)</b>	<b>282,961.4 ft<sup>2</sup> (26,288.0 m<sup>2</sup>)</b>	<b>241,111.4 ft<sup>2</sup> (22,400.0 m<sup>2</sup>)</b>

Table 4.4-2 PDE of OSS Foundation Dimensions and Seabed Disturbance (Continued)

Foundation Concept	Medium OSS			Large OSS		
	Piled Jacket	Suction Bucket Jacket	GBS	Piled Jacket	Suction Bucket Jacket	GBS
<b>Seabed Disturbance</b>						
<b>Temporary Seabed Disturbance During Construction</b>						
Max. dimensions of seabed preparation per foundation	524.9 ft x 328.1 ft (160.0 m x 100.0 m)	590.6 ft x 393.7 ft (180.0 m x 120.0 m)	442.9 ft x 393.7 ft (135.0 m x 120.0 m)	639.8 ft x 475.7 ft (195.0 m x 145.0 m)	695.5 ft x 531.5 ft (212.0 m x 162.0 m)	557.7 ft x 524.9 ft (170.0 m x 160.0 m)
Max. depth of seabed preparation <sup>c</sup>	19.7 ft (6.0 m)	19.7 ft (6.0 m)	19.7 ft (6.0 m)	19.7 ft (6.0 m)	19.7 ft (6.0 m)	19.7 ft (6.0 m)
Max. area of seabed preparation per foundation	172,222.6 ft <sup>2</sup> (16,000.0 m <sup>2</sup> )	232,500.5 ft <sup>2</sup> (21,600.0 m <sup>2</sup> )	174,375.4 ft <sup>2</sup> (16,200.0 m <sup>2</sup> )	304,349.6 ft <sup>2</sup> (28,275.0 m <sup>2</sup> )	369,675.7 ft <sup>2</sup> (34,344.0 m <sup>2</sup> )	292,778.4 ft <sup>2</sup> (27,200.0 m <sup>2</sup> )
Avg. volume of seabed preparation per foundation <sup>d</sup>	565,034.7 ft <sup>3</sup> (16,000.0 m <sup>3</sup> )	762,796.8 ft <sup>3</sup> (21,600.0 m <sup>3</sup> )	572,097.6 ft <sup>3</sup> (16,200.0 m <sup>3</sup> )	998,522.2 ft <sup>3</sup> (28,275.0 m <sup>3</sup> )	1,212,846.9 ft <sup>3</sup> (34,344.0 m <sup>3</sup> )	960,558.9 ft <sup>3</sup> (27,200.0 m <sup>3</sup> )
Max. area of disturbance due to jack-up or anchored vessels per foundation <sup>e</sup>	47,361.2 ft <sup>2</sup> (4,400 m <sup>2</sup> )	47,361.2 ft <sup>2</sup> (4,400 m <sup>2</sup> )	0.0 ft <sup>2</sup> (0.0 m <sup>2</sup> )	47,361.2 ft <sup>2</sup> (4,400 m <sup>2</sup> )	47,361.2 ft <sup>2</sup> (4,400 m <sup>2</sup> )	0.0 ft <sup>2</sup> (0.0 m <sup>2</sup> )
<b>Max. total temporary seabed disturbance beyond permanent footprint per foundation</b>	<b>138,425.7 ft<sup>2</sup> (12,860.2 m<sup>2</sup>)</b>	<b>97,256.1 ft<sup>2</sup> (9,035.4 m<sup>2</sup>)</b>	<b>25,833.4 ft<sup>2</sup> (2,400.0 m<sup>2</sup>)</b>	<b>214,756.5 ft<sup>2</sup> (19,951.5 m<sup>2</sup>)</b>	<b>134,075.1 ft<sup>2</sup> (12,456.0 m<sup>2</sup>)</b>	<b>51,666.7 ft<sup>2</sup> (4,800.0 m<sup>2</sup>)</b>
<b>Total Temporary and Permanent Seabed Disturbance During Construction</b>						
<b>Max. total area of seabed disturbance per foundation</b>	<b>219,583.6 ft<sup>2</sup> (20,400.0 m<sup>2</sup>)</b>	<b>279,861.4 ft<sup>2</sup> (26,000.0 m<sup>2</sup>)</b>	<b>174,375.2 ft<sup>2</sup> (16,200.0 m<sup>2</sup>)</b>	<b>351,710.4 ft<sup>2</sup> (32,675.0 m<sup>2</sup>)</b>	<b>417,036.5 ft<sup>2</sup> (38,744.0 m<sup>2</sup>)</b>	<b>292,778.1 ft<sup>2</sup> (27,200.0 m<sup>2</sup>)</b>
<b>Installation Timeframe</b>						
Approx. max. duration to drive one pile	3-4 hours	N/A	N/A	3-4 hours	N/A	N/A
Max. # of piles driven per day	4	N/A	N/A	4	N/A	N/A

- Notes:
- a) The footprint of any mud mats (if used) are included in the "Max. total permanent footprint" rather than the "Total foundation footprint contacting seabed."
  - b) Scour protection may occur in any shape and size up to the maximum footprint provided above, including the possibility of no scour protection.
  - c) In the worst case situation, in a limited number of foundation positions, up to 19.7 ft (6 m) of seabed leveling could be required. Piled and suction bucket foundations are not expected to require seabed preparation unless the seabed is not sufficiently level.
  - d) The maximum total volume of seabed preparation for the OSS foundations will not exceed the average volume for an individual foundation multiplied by the maximum number of foundations.
  - e) OSS foundation installation using jack-up vessels is expected to involve one main installation jack-up vessel with a maximum disturbance of 10,763.9 ft<sup>2</sup> (1000.0 m<sup>2</sup>) (four legs, each disturbing 2,691.0 ft<sup>2</sup> [250.0 m<sup>2</sup>]) and one feeder-jack-up vessel with a maximum disturbance of 4,869.5 m<sup>2</sup> (452.4 m<sup>2</sup>) (four legs, each disturbing 1,217.4 ft<sup>2</sup> [113.1 m<sup>2</sup>]) at each position. If an anchored HLV is used, foundation installation is expected to involve one anchored HLV with a maximum disturbance of 47,361.2 ft<sup>2</sup> (4,400 m<sup>2</sup>) (four anchors, each with a disturbance of 1,076.4 ft<sup>2</sup> [100.0 m<sup>2</sup>] for the anchor itself plus 10,763.9 ft<sup>2</sup> [1,000.0 m<sup>2</sup>] for the mooring system) at each position. Any feeder barge(s) would moor to the HLV and cause no additional disturbance. The scenario resulting in the greatest seafloor disturbance for each OSS type is assumed in the table above. Additional emergency anchoring or jacking-up may be required.



#### 4.4.2 Topside Design, Installation, and Commissioning

Power generated by the WTGs will be transmitted to the OSSs via 66 kV to 150 kV inter-array cables, which will connect to circuit breakers and transformers located within the OSS topsides. These transformers will increase the voltage level to the export cable voltage (230 kV to 525 kV). From the OSSs, the export cables will transmit electricity to shore. Additional information about the offshore cables is included in Section 4.5.

The PDE of OSS topside parameters is provided in Table 4.4-3.

Table 4.4-3 PDE of OSS Topside Dimensions

Topside Parameter	Small OSS	Medium OSS	Large OSS
Max. # of OSSs	10	5	4
Max. Width	114.8 ft (35.0 m)	147.6 ft (45.0 m)	164.0 ft (50.0 m)
Max. Length	131.2 ft (40.0 m)	213.3 ft (65.0 m)	295.3 ft (90.0 m)
Max. Height above Foundation Interface	98.4 ft (30.0 m)	114.8 ft (35.0 m)	131.2 ft (40.0 m)
Max. Height of Topside above MLLW	174.8 ft (53.3 m)	191.2 ft (58.3 m)	207.6 ft (63.3 m)

The OSSs will be designed according to site-specific conditions, including winter storms, hurricanes, and tropical storms, based on industry standards such as ACP, IEC, API, and ISO standards.

Although the precise electrical equipment contained in the OSS topsides will be determined as the engineering design advances, each OSS will contain power transformers, which will vary in size depending on the type of OSS (HVAC or HVAC/HVDC) and electrical capacity. The OSS topsides are also expected to include:

- switchgear
- transformers
- control and communications equipment
- shunt reactors
- fire detection and firefighting equipment (e.g., inert gas and/or water/foam systems)
- cranes
- safety equipment (e.g., life rafts or boats, lifejackets)
- freshwater storage
- clean water wash system

- UPS system and associated batteries
- backup diesel generator
- diesel fuel storage
- utility pumps for systems such as freshwater, diesel fuel, and cooling.
- oil containment

Lightning masts or air terminals will be installed on OSS topsides to protect electrical equipment and personnel. Heating, ventilation, and air conditioning systems will be installed in the OSS to regulate equipment temperatures.

During construction and operation, the OSSs will be lighted and marked in accordance with FAA, USCG, and BOEM guidelines to aid safe navigation within the WTA. Lighting and marking of the OSSs during the operations period are discussed in Section 5.3. Atlantic Shores does not currently anticipate installing helicopter pads on the OSSs, though this feature may be added depending on the O&M strategy employed (see Section 5.6). If a helicopter pad is included, it will be designed to support a USCG helicopter and appropriate lighting, and marking will be included as required.

The OSS topsides are expected to be fabricated outside of the U.S. and transported directly to the WTA on the installation vessel, a HTV, or ocean-going barge. Although unlikely, if an OSS is staged at a U.S. port prior to installation, shore-based equipment such as crawler cranes and SPMTs would unload the OSS topside and transport it to port storage. Then, the OSS topside would be loaded onto a vessel to be transported to the WTA for installation. Once at the WTA, the OSS topsides are expected to be lifted from the transport vessel onto the OSS foundation using a crane on a jack-up vessel or HLV using either DP or anchors (see Figure 4.4-2).

Alternatively, the OSS topsides may be pulled by tugboats and floated to the WTA, after which the topsides would be ballasted down over an installed OSS foundation or jack-up legs integrated into the topside would lower to the seabed and raise the topside to its target elevation.

After the OSS topside is secured to its foundation, the OSS will be commissioned. During commissioning, the electrical and safety systems on the OSS will be tested and the OSS will be energized. A jack-up vessel or floating vessel may be used to provide accommodations for the personnel commissioning the OSSs. Any seabed disturbance from vessels used during installation and commissioning of the OSS topsides will occur within surveyed areas of the WTA. The PDE of seabed disturbance for OSS topside installation and commissioning is described in Table 4.4-4.

Table 4.4-4 Maximum Seabed Disturbance from OSS Topside Installation and Commissioning

Installation Activity	PDE
Max. area of seafloor disturbance for OSS topside installation	47,361.2 ft <sup>2</sup> (4,400.0 m <sup>2</sup> ) per OSS  (assumes one HLV with four anchors, each with a disturbance of 11,840.3 ft <sup>2</sup> [1,100.0 m <sup>2</sup> ] for the anchor and mooring system) <sup>a</sup>
Max. area of seafloor disturbance for OSS commissioning	10,763.9 ft <sup>2</sup> (1,000.0 m <sup>2</sup> ) per OSS  (assumes one jack-up vessel with four legs, each with a disturbance of 2,691.0 ft <sup>2</sup> [250.0 m <sup>2</sup> ])
<b>Max. Total Seabed Disturbance from Anchors/Jack-Up Vessels During OSS Topside Installation and Commissioning</b>	<b>58,125.1 ft<sup>2</sup> (5,400.0 m<sup>2</sup>) per OSS</b>

Note:

- a) Alternatively, the topsides could be installed by a HLV operating on DP (i.e., with no seafloor disturbance) or a jack-up vessel with a maximum seafloor disturbance of 10,763.9 ft<sup>2</sup> (1,000.0 m<sup>2</sup>).

#### 4.4.3 Seabed Preparation and Scour Protection

As with WTG foundations, OSS foundations (particularly gravity foundations), may require seabed preparation (i.e., removing the uppermost sediment layer beneath the foundation). Gravity foundations are also expected to require gravity pads. Methods to complete seabed preparation are described in Section 4.2.4. The maximum dimensions of seabed preparation that could be required for each OSS foundation type is provided in Table 4.4-2.

Scour protection may be installed at the base of each OSS foundation to protect it from sediment transport/erosion caused by water currents. The different types of scour protection that could be placed around OSS foundations are the same as for WTG foundations and are described in Section 4.2.5. Dimensions of OSS foundation scour protection are included in Table 4.4-2.



**Lifting of Offshore Substation Topside Using Vessel Crane**

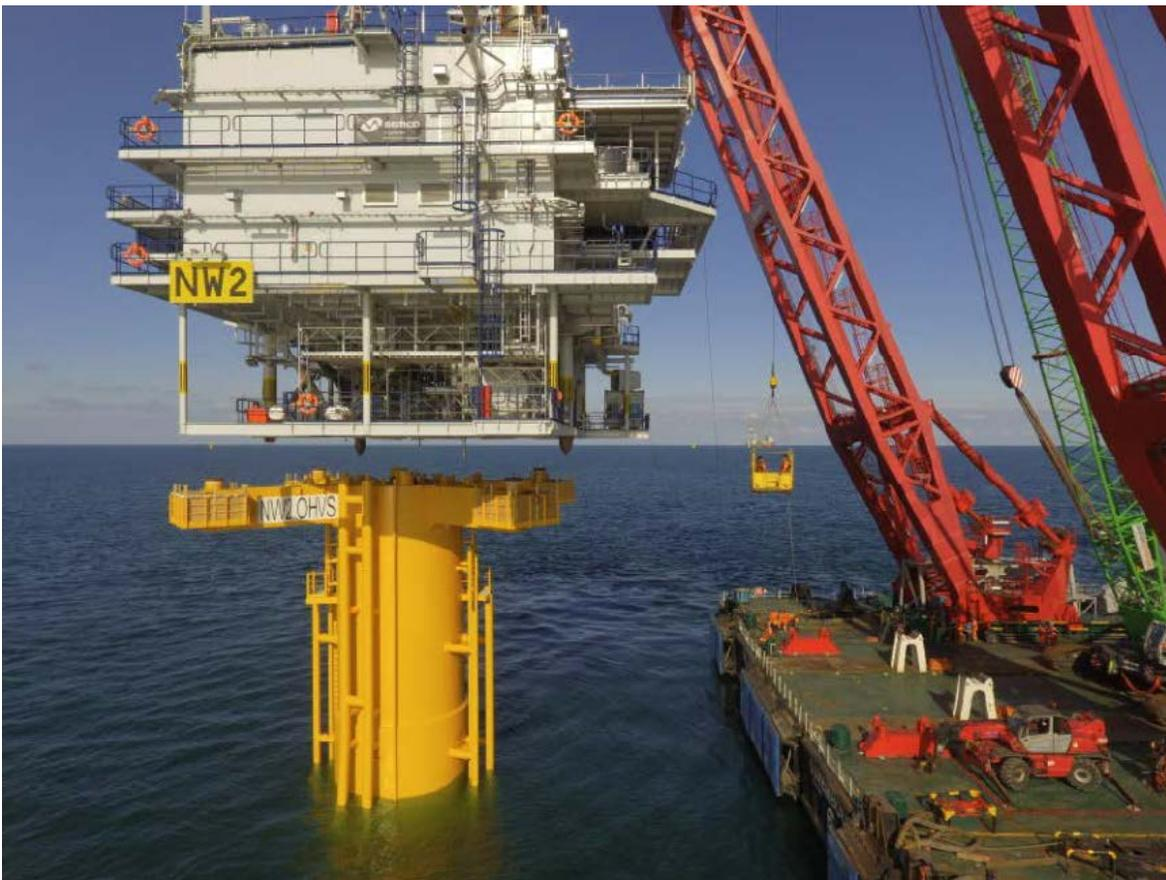

## 4.5 Offshore Cables

The Projects will include electrically distinct offshore export, inter-array, and possibly inter-link cables (the “offshore cables”). Up to eight export cables will be installed to deliver electricity from the OSSs to the landfall sites. The export cables from each Project have the potential to utilize either ECC or be co-located in the same ECC. Both Project 1 and 2 also include electrically distinct inter-array cables to connect strings of WTGs to an OSS, and may include inter-link cables to connect OSSs to each other.

### 4.5.1 Offshore Cable Design

#### 4.5.1.1 Export Cables

The Projects will each include HVAC export cables or HVDC export cables (bundled together). Both Projects 1 and 2 have the potential to use either ECC and may also be co-located within the same ECC. If HVAC cables are used, the voltage will be between 230 kV and 275 kV; if HVDC cables are used, a higher voltage between 320 kV and 525 kV will be used.

HVAC cables are expected to have three stranded-core conductors made of aluminum or copper that are encapsulated in a cross-linked polyethylene (XLPE) insulation system, a metallic screen, and a core jacket. The three power cores are bundled together and protected by an armor layer. All cables will contain fiber optics between the cores for communication and monitoring purposes. See Figure 4.5-1 for a schematic of a typical HVAC export cable. The HVAC export cables will have a maximum outer diameter of approximately 12.6 inches (in) (320 millimeters [mm]).

HVDC cables are expected to have single-core stranded conductors made of aluminum or copper each encapsulated in an XLPE insulation system, a metallic screen, a core jacket, and protected by an armor layer (see Figure 4.5-2). Each HVDC circuit is composed of two HVDC cables. The two HDVC cables and external fiber optic cables would be bundled together and installed simultaneously. The HVDC export cables will have a maximum width of approximately 14.2 in (360 mm).

The export cable design will likely include a distributed temperature system (DTS) and may include other monitoring systems such as distributed acoustic sensing (DAS) system or online partial discharge (OLPD) monitoring to constantly assess the status of offshore cables and detect anomalous conditions, insufficient or excess cable depth, or potential damage (see Section 5.1 for additional details).

The target burial depth of the export cables will be 5 to 6.6 ft (1.5 to 2 m). Section 4.5.4 contains a description of offshore cable installation techniques. The total maximum seafloor impacts for Project 1, Project 2, and both Projects combined are presented in Section 4.5.10.

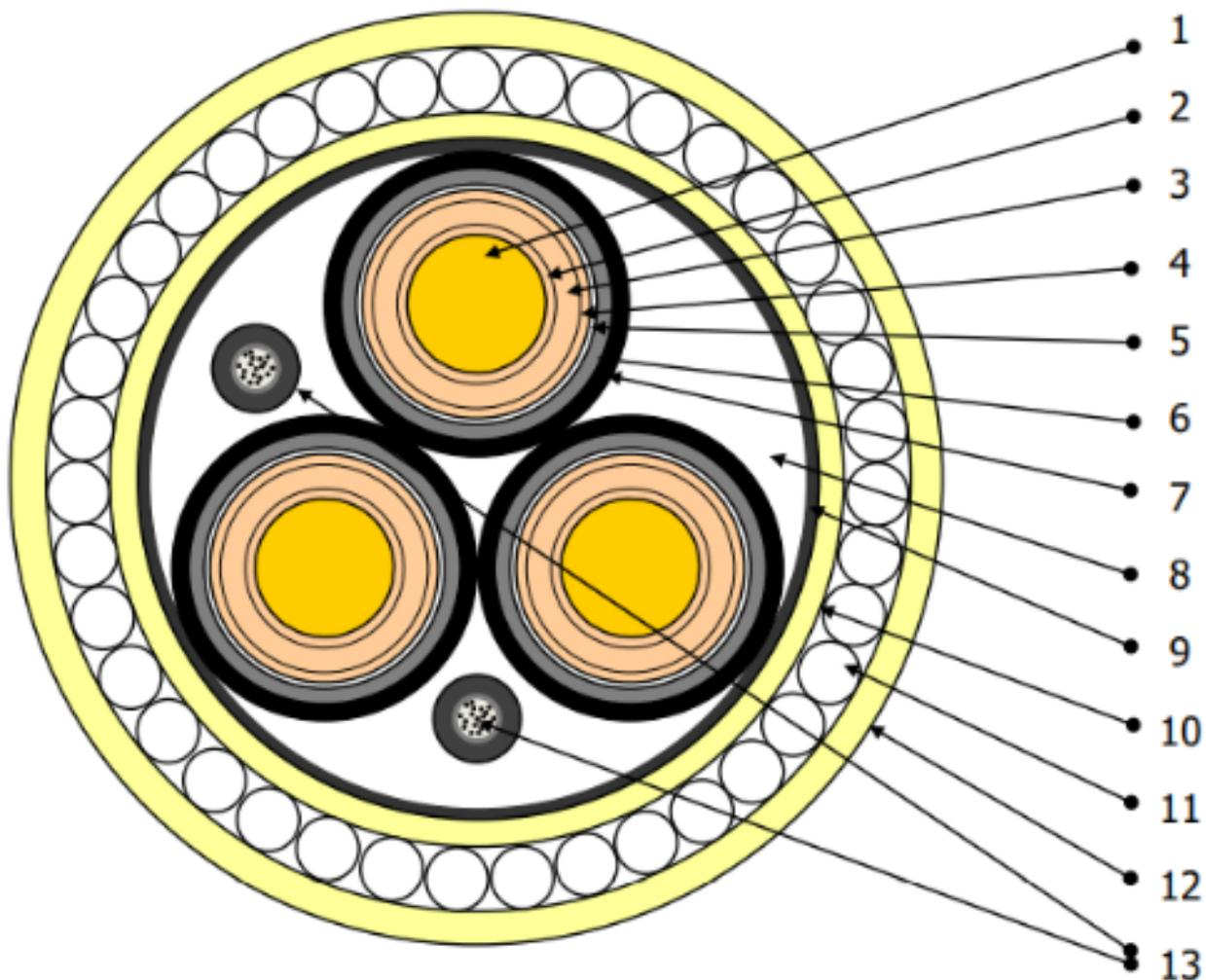

Label	Description
1	Conductor
2	Conductor screen
3	Insulation
4	Insulation screen
5	Water blocking layer
6	Metallic sheath
7	Anti-corrosion sheath
8	Filler
9	Binder tape
10	Armor bedding
11	Wire armor
12	Serving
13	Fiber Optic Cables

## Individual HVDC Cable

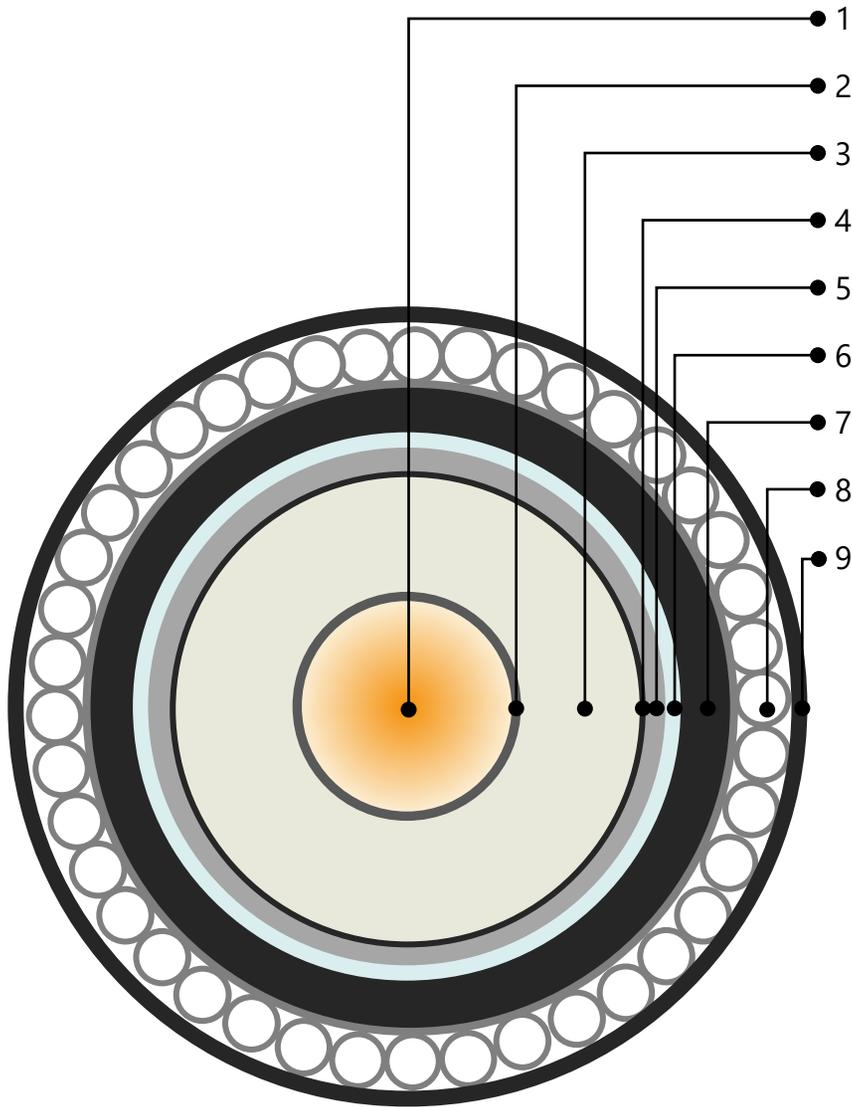

Label	Description	Material
1	Conductor	Copper or Aluminum
2	Conductor screen	Extruded semi conductive compound
3	Insulation	XLPE
4	Insulation screen	Extruded semi conductive compound
5	Metallic sheath	Lead alloy / Semi conducting swelling tape to prevent longitudinal water penetration
6	Core sheath	Semi conducting polyethylene
7	Armor bedding	Non-conductive tapes
8	Armor	Galvanized steel wires
9	Outer serving	Polypropylene yarns

## Bundled HVDC Cables

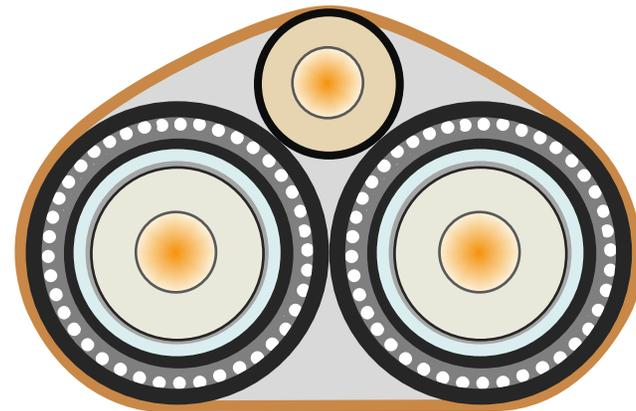

#### 4.5.1.2 Inter-Array and Inter-Link Cables

Project 1 and Project 2 will have electrically distinct inter-array and inter-link cables. The HVAC inter-array cables will have a voltage between 66 and 150 kV and a maximum outer diameter of 8.5 in (215 mm). The HVAC inter-link cables, if used, will have a voltage between 66 and 275 kV and a maximum outer diameter of 12.6 in (320 mm).

Each inter-array and inter-link cable is expected to have three stranded-core conductors made of aluminum or copper, each encapsulated in an XLPE insulation system, a metallic screen, and a core jacket (see Figure 4.5-3). The three power cores are bundled together and protected by an armor layer. All cables will contain optical fibers embedded between the cores for communication and monitoring purposes. The cable design will limit water propagation along the cable core in case of cable damage. Similar to the export cables, the inter-array and inter-link cables may include monitoring systems such as DAS, DTS, or OLPD.

The target burial depth of the inter-array and inter-link cables will be 5 to 6.6 ft (1.5 to 2 m). Section 4.5.4 contains a description of offshore cable installation techniques. The total maximum seafloor impacts for Project 1, Project 2, and both Projects combined are presented in Section 4.5.10.

#### 4.5.2 Offshore Cable Routes

##### 4.5.2.1 Export Cable Corridors

The export cables will be installed within the Atlantic ECC and/or the Monmouth ECC (see Figure 4.5-4 and 4.5-5, respectively). The width of each ECC corresponds to the width of the marine survey corridors and ranges from approximately 3,300 to 4,200 ft (1,000 to 1,280 m) for all of the Monmouth ECC and most of the Atlantic ECC, though the Atlantic ECC widens to approximately 5,900 ft (1,800 m) near the Atlantic Landfall Site. The width of each ECC is needed to accommodate up to four export cables, as well as the associated cable installation vessel activities, and allows for avoidance of resources such as shipwrecks and sensitive habitats (see Section 3.3). Variations in width at the landfall sites are needed to accommodate the construction vessel activities necessary to support the landfall of each export cable via horizontal directional drilling (HDD).

A minimum separation distance of approximately 330 ft (100 m) is planned between the HVAC export cables installed within each ECC. The cables will typically be separated by 410 to 820 ft (125 to 250 m), depending on route constraints and water depths. This separation distance, which provides flexibility for routing and installation as well as for future cable repairs (if needed), may be adjusted pending ongoing evaluation and site conditions.

The ECC from the WTA boundary to the Atlantic Landfall Site is approximately 12 mi (19 km). The maximum length of each export cable from the Atlantic Landfall Site to an OSS is approximately 25 mi (40 km), including the length of the export cable within the WTA and contingency for micro-



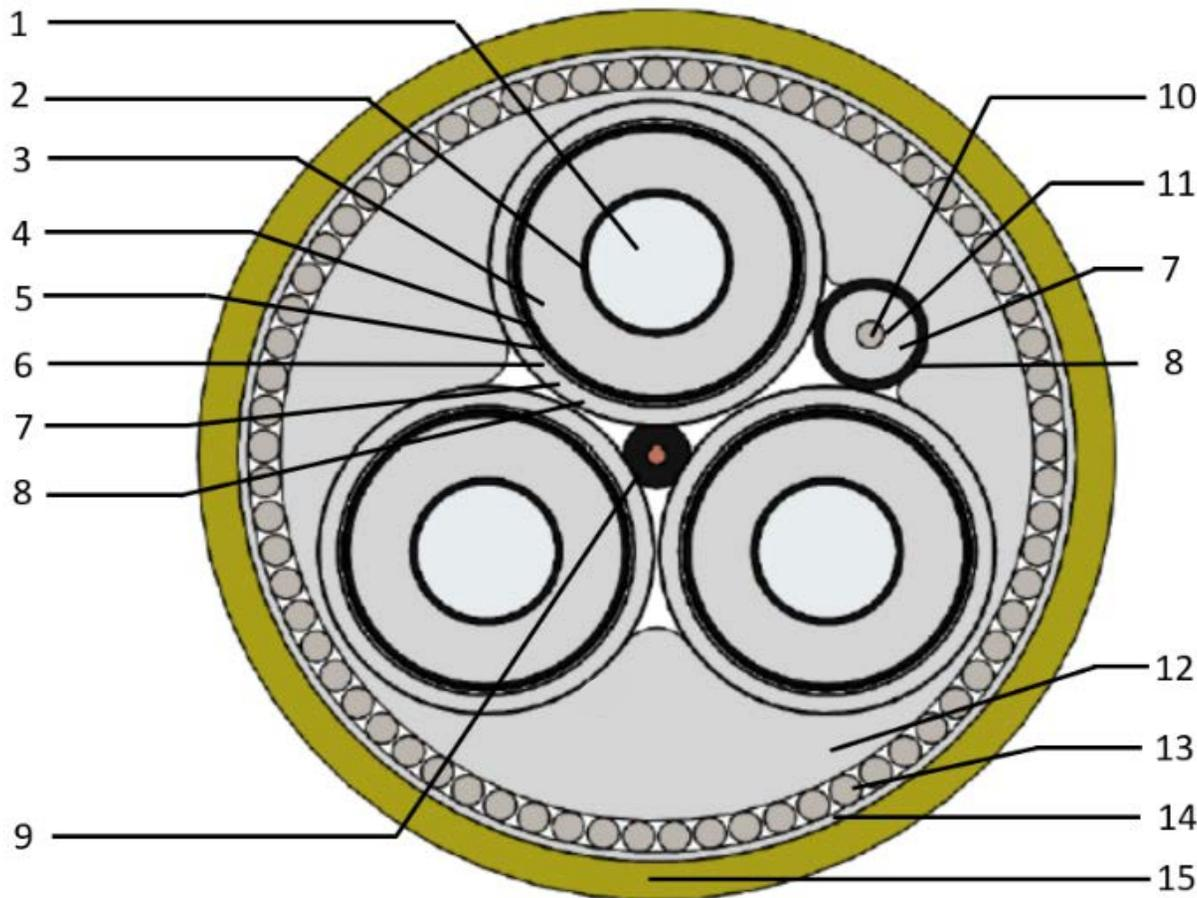

Label	Description
1	Conductor
2	Conductor screen
3	XLPE insulation
4	Insulation screen
5	Water blocking tape
6	Aluminum tube
7	HDPE Sheath
8	Semi-conducting skin
9	Drain wire & semi-conducting sheath
10	Optical fibers in gel
11	Stainless steel tube
12	Filling
13	Steel wire armor
14	Binding tape
15	PE outer sheath

8/20/2021 | G:\Projects\VA\5655\2021\Task\_1\Map\Fig 4.5-4 Atlantic Export Cable Corridor (ECC)\_20210819.mxd

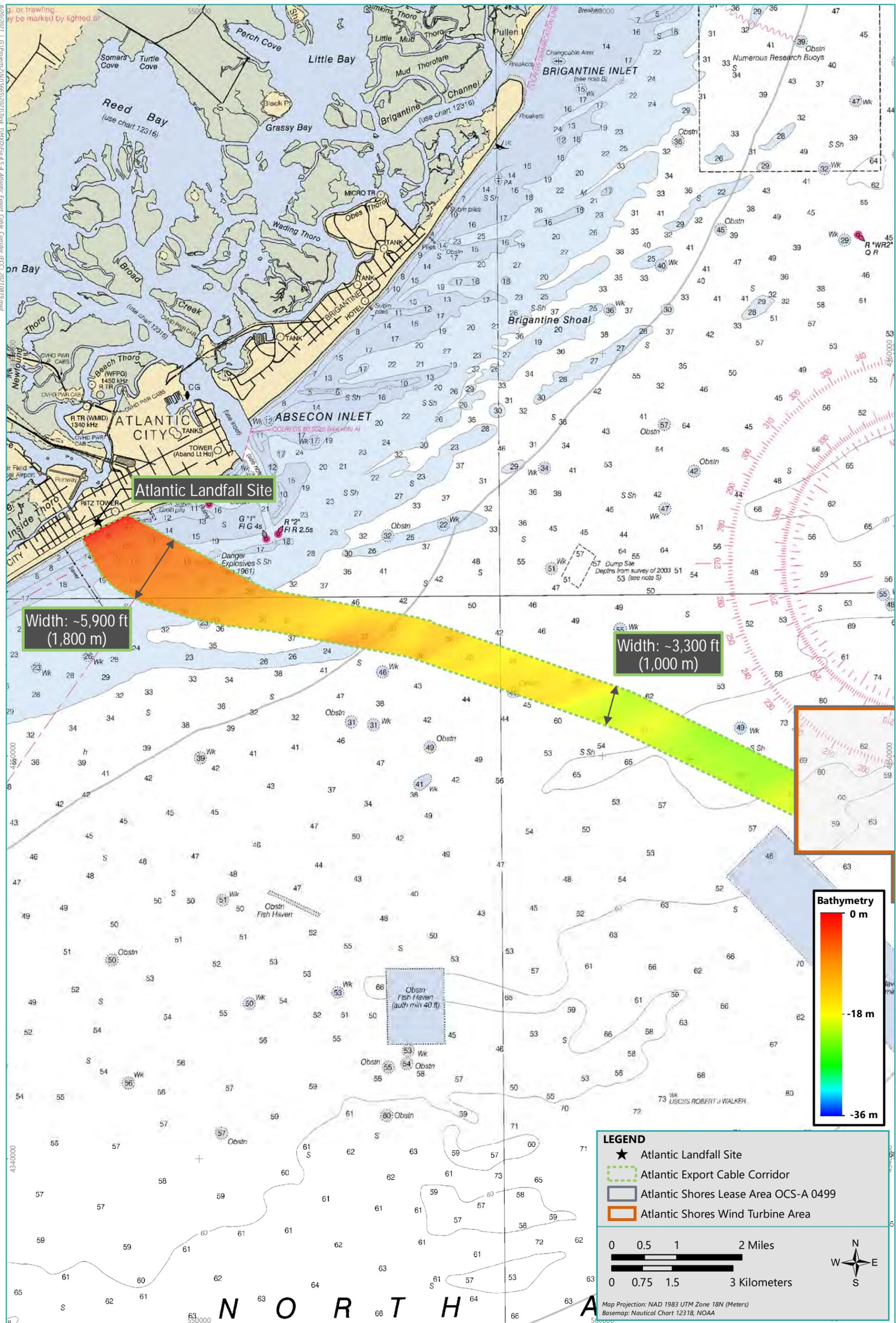

Width: ~5,900 ft  
(1,800 m)

Width: ~3,300 ft  
(1,000 m)

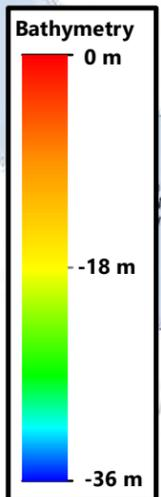

**LEGEND**

- ★ Atlantic Landfall Site
- Atlantic Export Cable Corridor
- Atlantic Shores Lease Area OCS-A 0499
- Atlantic Shores Wind Turbine Area

0 0.5 1 2 Miles  
 0 0.75 1.5 3 Kilometers

Map Projection: NAD 1983 UTM Zone 18N (Meters)  
 Basemap: Nautical Chart 12318, NOAA

**Figure 4.5-4**  
Atlantic Export Cable Corridor (ECC)

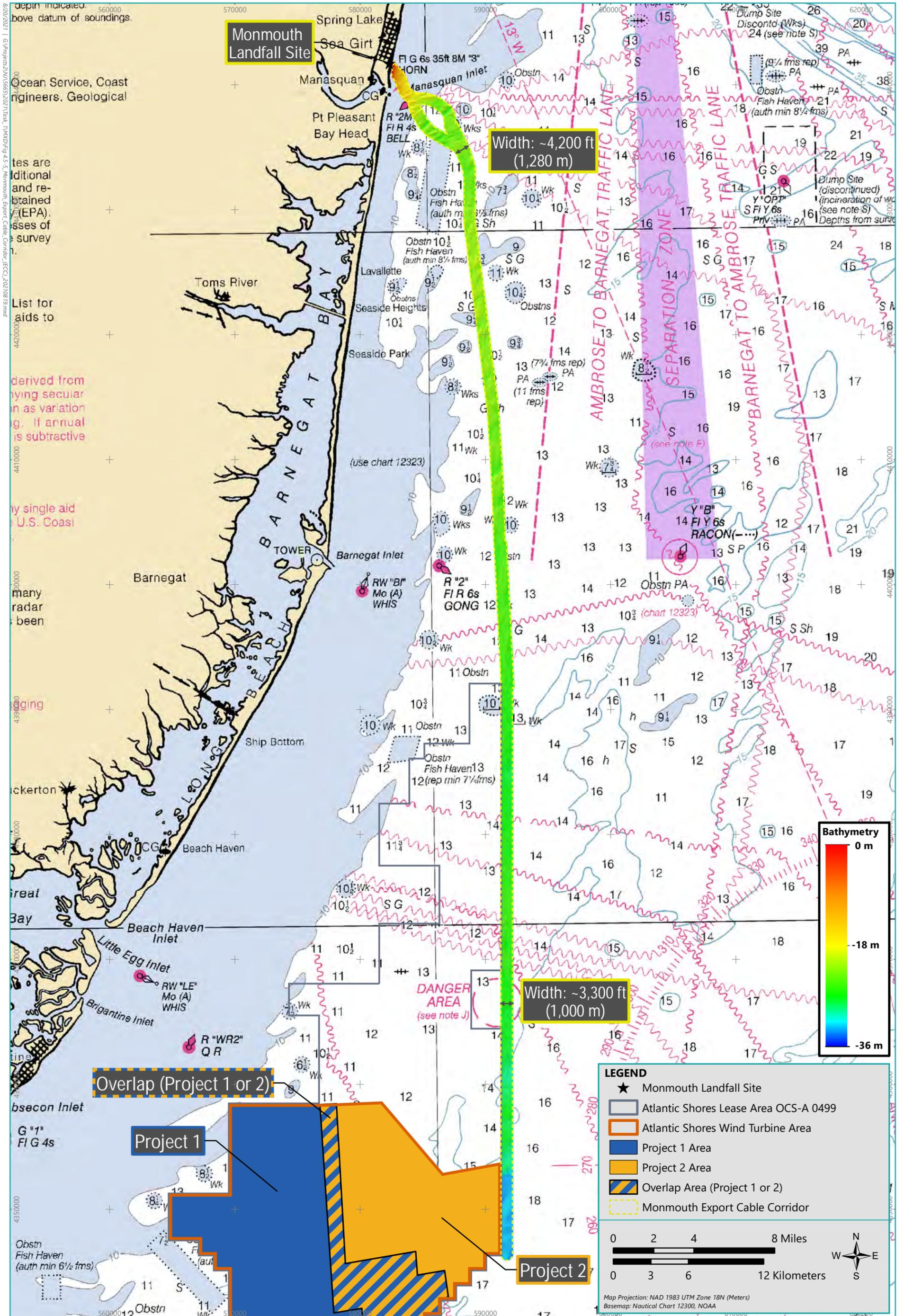

**Figure 4.5-5**  
Monmouth Export Cable Corridor (ECC)

siting. The ECC from the WTA boundary to the Monmouth Landfall Site is approximately 61 mi (98 km). Each export cable from the Monmouth Landfall Site to an OSS has a maximum length of approximately 85 mi (138 km) when accounting for the length of the export cable within the WTA and contingency for micro-siting. If four export cables are installed in each ECC (for a total of eight export cables), the total maximum export cable length will be 441 mi (710 km). Neither ECC crosses established navigation channels.

#### 4.5.2.2 Inter-Array and Inter-Link Cable Routes

The electrically distinct inter-array cables and inter-link cables (if used) for each Project will be installed within surveyed corridors in the WTA where full archaeological and geological assessments will have been completed. Atlantic Shores will engineer potential inter-array and inter-link cable layouts based on the results of surveys conducted in 2021. For both Projects, Atlantic Shores anticipates that up to 547 mi (880 km) of inter-array cables and up to approximately 37 mi (60 km) of inter-link cables may be needed. Project 1 and Project 2 will each have a maximum of 273.5 mi (440 km) of inter-array cables and up to approximately 18.6 mi (30 km) of inter-link cables.

#### 4.5.3 Pre-Installation Activities

Activities that will be conducted prior to cable installation include sand bedform clearing, relocation of boulders, a pre-lay grapnel run, and a pre-lay survey.

##### 4.5.3.1 Boulder Relocation

Boulder relocation may be required prior to cable installation in limited areas along the final export cable alignments within the ECCs. If required, this will likely be executed by subsea grab, since the presence of boulders is expected to be minimal and this method allows for minimal seabed impact (impact will be limited to a boulder's original footprint and its final, relocated footprint).

If more boulders than expected are encountered, a displacement plow could be selected for clearing the area. This plow is anticipated to clear an approximately 33-ft-wide (10-m-wide) corridor for up to 10% of each export cable. A displacement plow is a simple and robust Y-shaped design configured with a boulder board attached. This plow, which is towed along the seabed by a vessel, displaces boulders along a clearance path as it passes along the seabed surface. The plow will normally be ballasted to only clear boulders (to a depth of up to 31 in [800 mm]) to avoid creating a deep depression in the seabed. The maximum area of seabed disturbance from boulder relocation is provided in Section 4.5.10.

##### 4.5.3.2 Sand Bedform Removal

The expected presence of mobile sand bedforms (i.e., ripples, megaripples, and sand waves) within the ECCs and WTA may necessitate the removal of the tops of some sand bedforms prior to offshore cable installation to ensure the cables can be installed within stable seabed. Sand

bedform removal will be limited only to the extent required to achieve adequate cable burial depth. Project engineers estimate that up to 20% of the export cable routes, 10% of the inter-array cable routes, and 20% of the inter-link cable routes may require sand bedform removal. The maximum dredge areas and volumes are provided in Section 4.5.10.

Sand bedform removal is expected to be completed with one or more of the following typical methodologies (see Figure 4.5-6):

- **Trailing suction hopper dredge (TSHD):** In this dredging method, one or two suction pipes, each equipped with a trailing drag head, descend from the side of the dredging vessel to the seabed. Each drag head is fitted with nozzles that direct high-pressure water at the seabed to loosen seabed material. Due to lower pressure in the pipe, the loosened material is sucked up and discharged into the vessel's hopper. Once collected, dredged materials can be discharged via the bottom doors of the vessel or a pipe that releases dredged material lower in the water column. The collected material will be disposed of within surveyed areas exhibiting sand bedforms, avoiding hard-bottom areas and allowing the volume to be winnowed away by normal currents and tidal actions. Some portion of the dredged sand may also be used for ballast in GBS foundations if those foundations are selected for the Projects. Alternatively, if required, the removed material could be transported a short distance to an agreed-upon disposal site outside the Lease Area.
- **Controlled flow excavation:** Controlled flow excavators are equipped with rotating propellers capable of producing high-volume water columns which, when directed at the seabed, rapidly excavate sediments. The tool can be gyroscopically stabilized and deployed either from a crane or A-frame on the cable installation vessel. Controlled flow excavation may also be used for repairs or removal of cables in soft soils such as silt or loose/medium sand.
- **Route clearance plow:** A route clearance plow pushes sand aside, clearing the way for cable installation. Similar to the use of controlled flow excavation, use of a route clearance plow does not involve collecting sand from the seabed; rather, removed sand is cast aside adjacent to the cable alignments.

In addition to these typical methodologies, two additional specialty methods may be used in limited areas:

- **Cutterhead dredging:** This type of dredging is similar to TSHD but is used in hard or rocky seabed conditions. The method employs a cutterhead, which is similar to a large drill, that breaks up the seabed and loosens it for suction dredging. Given the harder substrate, the rate of production is slower than with a TSHD. Cutterhead dredging is not expected within the WTA, but could be required if rocky seabed is encountered along the ECCs.

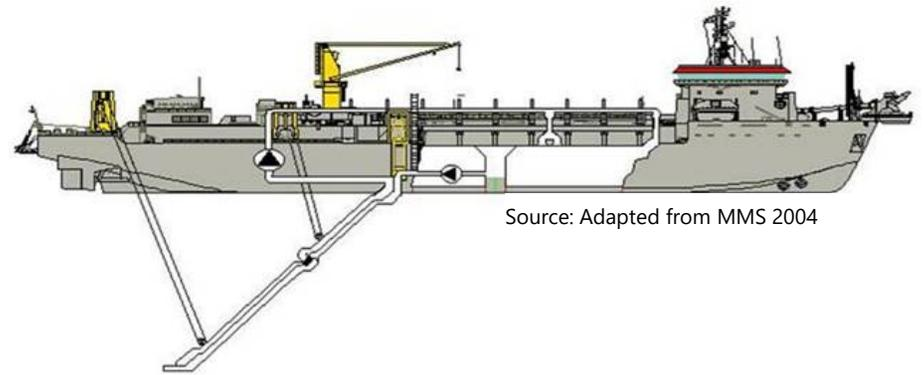

Source: Adapted from MMS 2004

**Trailing Suction Hopper Dredge**

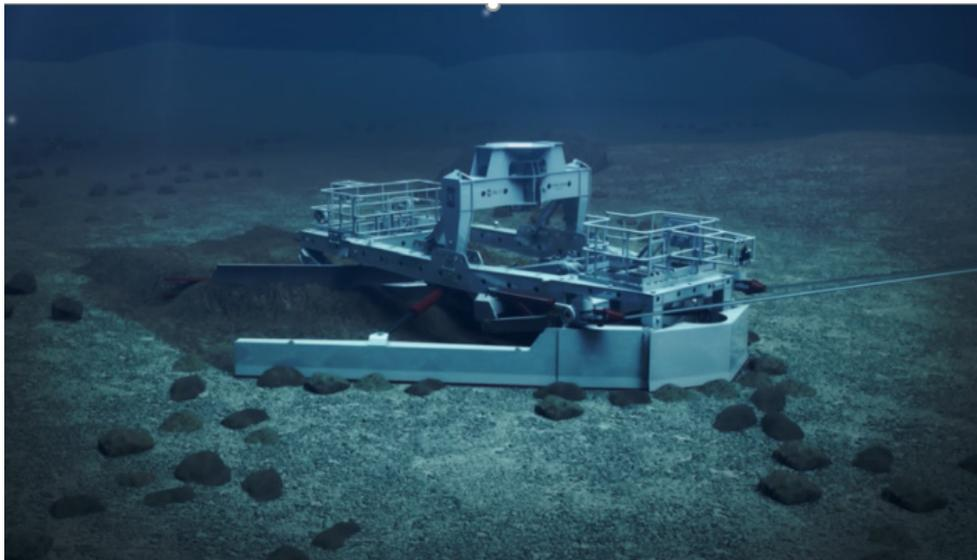

**Route Clearance Plow**



**Controlled Flow Excavation**

- **Backhoe dredging:** This type of dredging is more likely to be used in shallow, nearshore areas where only a small amount of material may need to be removed. The backhoe dredging equipment operates in the same way as an onshore backhoe excavator but is mounted on a small barge either with or without stabilizing spud legs. Underwater works are typically monitored using either multibeam or blue-view cameras attached to the vessel. Material extracted in the backhoe may be sidecast or it could be deposited in either a hopper on the barge or on a separate hopper vessel before proper disposal.

#### 4.5.3.3 Pre-lay Grapnel Run

Within approximately two months prior to cable installation, Atlantic Shores will perform a pre-lay grapnel run to clear the final cable alignments of human-made obstructions/debris such as discarded fishing wires, nets, or ropes. To complete the pre-lay grapnel run, a vessel will tow an approximately 3.3 ft-wide (1 m-wide) grapnel train consisting of a series of hooks designed to snag debris (see Figure 4.5-7). Measuring tension on the grapnel train towing rope will indicate whether debris is caught on the hooks. Atlantic Shores expects to make three passes with the grapnel train along each cable alignment. The first pass will likely be placed on the centerline of the cable alignment and the remaining two passes will occur parallel to and slightly offset from the centerline (within approximately 25 ft [7.5 m] to each side). The pre-lay grapnel runs will impact the seafloor to a maximum depth of 1.6 ft (0.5 m), subject to prevailing sediment conditions. The total area of seabed disturbance from the pre-lay grapnel runs is provided in Section 4.5.10.

#### 4.5.3.4 Pre-lay Surveys

Atlantic Shores will perform pre-lay surveys along the final planned cable alignments shortly before cable installation to confirm seabed morphology and bathymetry before the start of cable-laying operations and to detect any objects that may affect the future infrastructure. These surveys will consist of multibeam echo-sounder surveys in a corridor at least 65 ft (20 m) wide centered on the cable alignments, with the total width of the survey encompassing the entire area of seabed to be disturbed by cable installation activities.

#### 4.5.4 Cable Installation

The export cables, the inter-array cables, and any inter-link cables will be transported to the WTA or ECCs via one of two methods: direct or marshalled. Since the cables will likely be manufactured outside the U.S., the direct method of delivery is expected to involve a cable installation vessel being loaded at the factory or port and sailing to the Offshore Project Area to complete the cable installation. In this scenario, it is possible that the same vessel will sail back to its origin, obtain the next load of cable, and return to the WTA or ECC to complete the installation; alternatively, a second cable installation vessel could sail from the origin.

The marshalled method would have a similar first step consisting of a cable installation vessel sailing from its origin to the Offshore Project Area to install the first batch of cable. Meanwhile, a subsequent batch of cable would be loaded onto a freighter that would sail to a U.S. port where

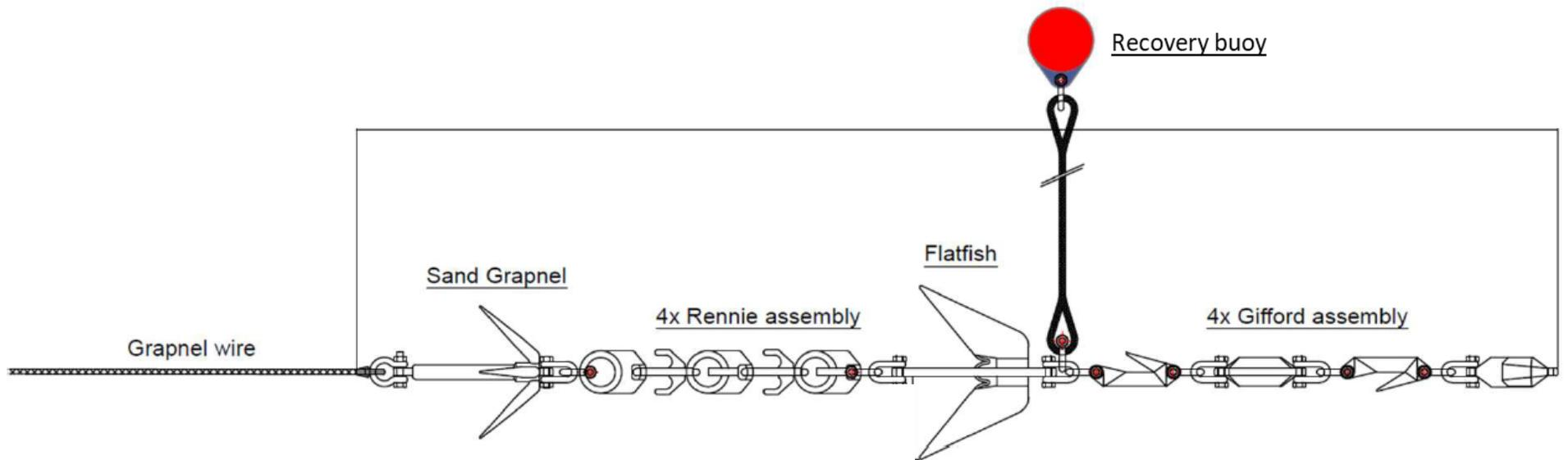



the cable would be spooled onto a carousel located onshore and stored quayside. Alternatively, the cables can be transported on pre-wound drums that are unloaded and transported into quayside storage using heavy lift cranes or SPMTs. After the first batch of cable is installed, the installation vessel would load the remaining batches from the U.S. port and install them in the Offshore Project Area. Inter-array and inter-link cables are lighter and easier to handle than the export cables, making staging at a U.S. port prior to installation more likely.

Three common methods may be used to lay and bury the export cables, inter-array cables, and/or inter-link cables:

- **Simultaneous lay and burial:** This is a combined process where the cable will be directly guided from the cable installation vessel through the burial tool and laid into the seabed. This approach will provide immediate protection of the cable following installation but is slower than laying cable with other methods depending on the tool employed (see the description of each tool below for installation speeds). Atlantic Shores expects to use simultaneous lay and burial to install the export cables.
- **Post-lay burial:** This process involves temporarily laying the cable onto the seabed followed by a subsequent, separate burial operation. With post-lay burial, the cables lie unprotected on the seabed between the laying and post-lay burial campaigns. Post-lay burial is especially appropriate for inter-array cables where the cables are buried close to WTG or OSS foundations and are relatively short lengths. Cable-laying without simultaneous burial could proceed at a rate of 985 to 1,970 ft per hour (300 to 600 m per hour). Post-lay burial can proceed at a faster burial rate than simultaneous lay and burial (see the description of each tool below for installation speeds) and is appropriate for the sediment types in the WTA. In particular, post-lay burial is expected to be used for the inter-array and inter-link cables because it allows them to be buried to their target depth closer to the foundations and facilitates performing multiple passes with the burial tool (where needed), hence minimizing the need for cable protection. Post-lay burial also results in a shorter duration of burial, thus minimizing the duration of cable installation impacts. Post-lay burial is not proposed as a primary installation technique for the export cables due to the longer lengths of export cables compared to the inter-array cables that would remain exposed, which would temporarily preclude other marine uses from the ECCs.
- **Pre-lay trenching:** This process involves excavating a trench prior to cable installation. The trench must remain clear before the cable is laid into the trench. Once the cable is laid, the trench is backfilled with spoils from the previous excavation. For the offshore cables, this technique is only expected to be used in limited circumstances where deeper cable burial (greater than the target depth of 5 to 6.6 ft [1.5 to 2 m]) may be required or firmer ground (such as clays or dense sands) is encountered.

Atlantic Shores is carefully evaluating available cable installation tools to select techniques that are appropriate for the site and that maximize the likelihood of achieving the target cable burial depth of 5 to 6.6 ft (1.5 to 2 m). The selection of equipment best suited for the task is an iterative

process that involves reviewing seabed conditions, cable properties, laying and burying combinations, burial tool systems, and anticipated performance. As shown on Figure 4.5-8, the three primary cable installation tools proposed are:

- **Jet trenching:** Water jetting systems can be used for simultaneous lay and burial or post-lay burial in soft soils such as silt or loose/medium sand. The tool's jetting legs contain numerous nozzles that produce water jets that create a fluidized channel of seabed sediment into which the cable sinks. The tool may be towed by the installation vessel, or it may be a "free-flying" ROV (i.e., neutrally buoyant and self-propelled on a tether). Jet trenching creates a trench approximately 1.3 to 3.3 ft (0.4 to 1.0 m) wide and operates at a burial rate of approximately 820 to 1,150 ft per hour (250 to 350 m per hour).
- **Plowing/jet plowing:** Typically used for simultaneous lay and burial, a plow's share cuts into the seabed, opening a trench to the required burial depth and holding it open with the side walls of the share. As the plow advances, the cable passes through the tool and falls into the open trench at the desired burial depth. Some plows are equipped with jetting nozzles in the share to increase performance. Plowing creates a trench approximately 1.6 ft (0.5 m) wide and operates at a burial rate of approximately 330 to 650 ft per hour (100 to 200 m per hour).
- **Mechanical trenching:** Mechanical cutting trenchers can be used for pre-lay trenching, simultaneous lay and bury, and post-lay burial operations in firmer ground such as clays or dense sands. This type of tool can be equipped with a jetting sword (using water jets) or excavation chain (with mechanical teeth) that cuts a narrow trench into the seabed. For simultaneous lay and bury operations, the cable passes through or over the tool, and as the trench is formed, a depressor directs the cable (within tolerances) into the trench. Mechanical cutting creates a trench approximately 2.1 ft (0.6 m) wide and operates at a burial rate of approximately 490 to 820 ft per hour (150 to 250 m per hour).

Cable installation is anticipated to create a trench with a maximum depth of approximately 10 ft (3 m) and a maximum width of up to approximately 3.3 ft (1 m). In addition to the direct trench impact, the installation tool's two skids or tracks (each approximately 6.6 ft [2 m] wide) could result in surficial seabed impacts. An anchored cable laying vessel may be used in shallow portions of the ECCs; no anchoring is expected in the WTA (see Section 4.5.10).

Most of the export, inter-array, and inter-link cables are expected to be installed using jet trenching (either simultaneous lay and burial or post-lay burial) or jet plowing, with limited areas of mechanical trenching. It is estimated that 80-90% of the offshore cables could be installed with a single pass of the cable installation tool. However, in limited areas expected to be more challenging for cable burial (along up to 10-20% of the export, inter-array, and inter-link cable routes), an additional one to three passes of the cable installation tool may be required to further lower the cable to its target burial depth.



**Representative Cable Laying Vessels**



**Jet Plow**



**Jet Trencher**

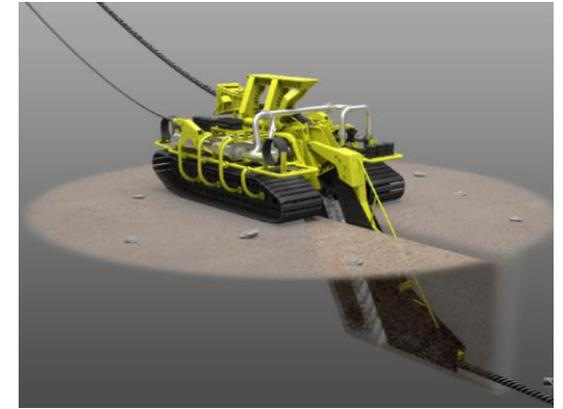

**Mechanical Trencher**

Additionally, for the export cables, an additional pass of the cable installation tool prior to installing the cable (known as pre-pass jetting) may be performed along up to 5% of the cable alignments to loosen sediments and increase the probability of successful burial. Geophysical and geotechnical surveys performed in 2020 will confirm the most likely locations where pre-pass jetting may be performed for the offshore cables. Finally, for export cable installation in shallow water, a shallow-water barge with tensioners to tow a plow may be used for simultaneous lay-and-bury.

To install an inter-array cable, a cable-laying vessel will first pull the end of an inter-array cable into a WTG or OSS foundation, then lay the cable along the route to the next WTG, where the second cable end will be pulled into the WTG or OSS foundation. The vessel will repeat the process until all WTGs in a string are connected to a single OSS. If post-lay burial is used, a cable burial vessel will then progress along the laid strings of inter-array cables, burying them to target depth. If simultaneous lay and burial is used, the cables will be installed to the target depth in a single operation. If inter-link cables are included in the Projects' final design, the same process will apply to inter-link cables, except these cables will connect OSSs to one another rather than to strings of WTGs.

#### 4.5.5 Export Cable Jointing

Given the length of the export cables, it is expected that they will be installed in one or more segments and that cable jointing offshore will be required. For either HVAC or HVDC export cables, a single joint per cable is anticipated for the Atlantic ECC. The longer route to the Monmouth Landfall Site could require up to four joints per cable.

After the installation of each export cable segment and prior to jointing, the end of the cable segment will be left on the seabed and held in temporary wet storage. In this case, temporary cable protection (e.g., concrete mattresses) may be placed over the cable end to avoid damage prior to splicing. To complete a joint, the end of a previously-laid cable will be brought onboard a jointing vessel (this could be a cable-laying vessel, jack-up vessel, or other specialized vessel) and into a jointing room. The end of the next cable to be installed will also be brought into the jointing room. There, the two ends will be joined together in a process that can take multiple days. Since jointing is a delicate operation, and because it occurs with the end of one cable extending up from the seabed and onboard the vessel, the operation requires several consecutive days of good weather. After a joint is complete, the vessel lowers the joint to the seabed, either in an omega shape or aligned with the previously-laid cable (i.e., an in-line joint), and the joint will be buried. If the joint is not too wide, it could be buried with a jet trencher; alternatively, controlled flow excavation could be used to cover the joint. If burial is not possible or practical due to sediment conditions, cable protection could be placed on top of the joint (see Section 4.5.7).

#### 4.5.6 Cable Pull-In and Commissioning

As described in Section 4.5.4, the inter-array cables and any inter-link cables will be pulled into the WTG and OSS foundations as they are installed. Depending on the final construction schedule, the ends of each export cable may be temporarily wet-stored (during which the cable ends are expected to be covered with cable protection) or directly pulled into the OSS.

Cable pull-in to a WTG or OSS foundation will be initiated by recovering a messenger wire from the foundation and bringing it to the cable laying vessel where the messenger wire will be connected to the end of the offshore cable. A winch on the foundation will then pull the cable (via the messenger wire) through the foundation's steel or composite j-shaped tube (j-tube), which is used to guide the cable into the foundation, and into the OSS topside or WTG tower/transition piece.

Where each cable approaches a foundation, the cable will likely be protected by a cable entry protection system intended to reduce fatigue and mechanical loads as the cables transition above the seabed and into the foundation (see Figure 4.5-9). This system may consist of different composite materials and/or cast-iron half-shells with suitable corrosion protection. It is most likely that the cable entry protection system will be attached to the cable prior to its placement on the seabed. If scour protection is used, the cable entry protection system would largely lie above the scour protection and may extend up to 19.7 ft (6.0 m) beyond the scour protection before transitioning beneath the seabed.

Once inside the foundation, the cable will be stripped to expose power cores and fiber optic cables in preparation for termination at the OSS or WTG. After termination is complete, the cables will be tested and commissioned prior to being energized.

#### 4.5.7 Cable Protection

Cable protection may be necessary if sufficient burial depth cannot be achieved (e.g., due to sediment properties or a cable joint). Cable protection may also be required to support the crossing of existing marine infrastructure such as submarine cables or pipelines (see Section 4.5.8). While Atlantic Shores will work to minimize the amount of cable protection required, it is conservatively assumed that up to 10% of the export cables, inter-array cables, and inter-link cables may require cable protection where sufficient burial depth is not achieved. The maximum dimensions of cable protection and area of seabed disturbance are provided in Section 4.5.10.

Atlantic Shores is considering the use of five types of cable protection:

1. **Rock placement:** up to three layers of rock, with the lower layer(s) consisting of smaller rock and the upper armor layer consisting of larger rock;
2. **Concrete mattresses:** high-strength concrete blocks cast around a mesh (e.g., ultra-violet stabilized polypropylene rope) that holds the blocks in a flexible covering that settles over the contours of a cable;

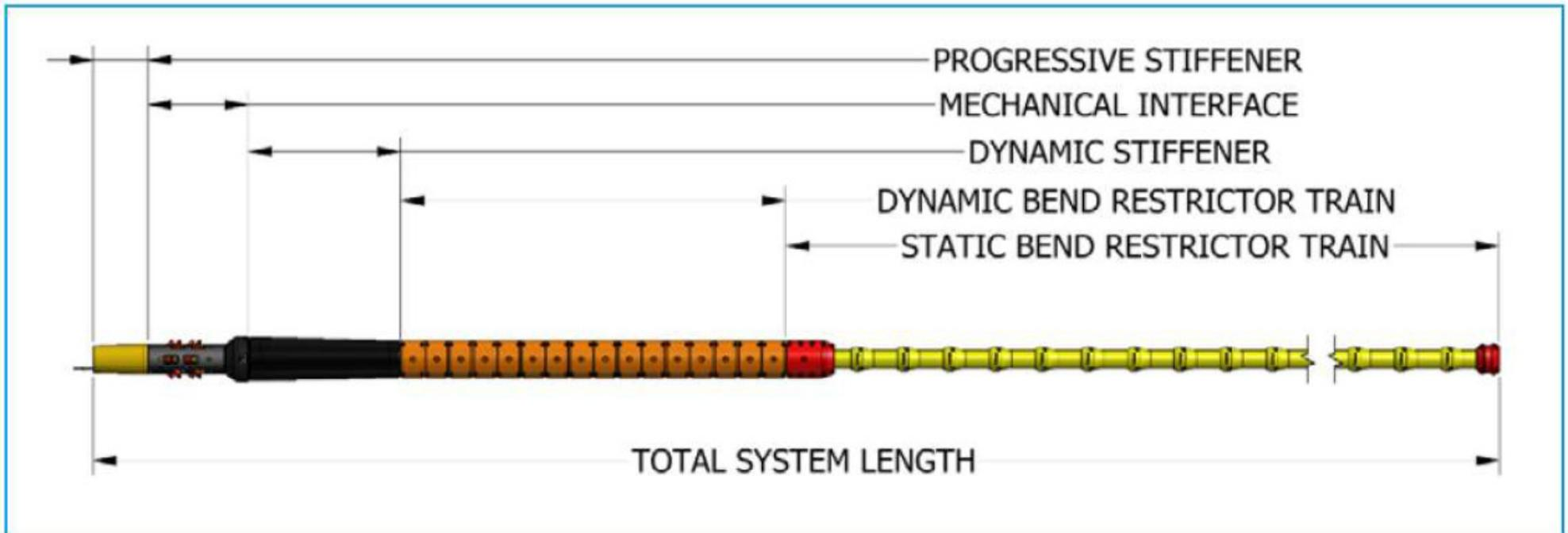
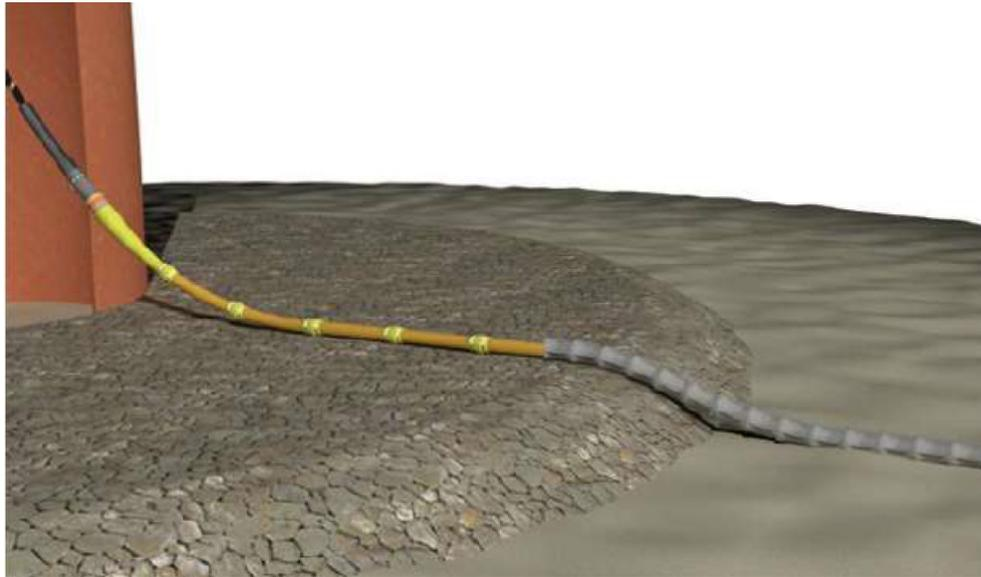

3. **Rock bags:** a rock-filled filter unit enclosed by polyester mesh that is non-corrosive, rot-proof, and weather-resistant with proven 30-year durability;
4. **Grout-filled bags:** woven fabric filled with grout that is placed under the cables to provide support or over the cables to provide protection; and
5. **Half-shell pipes:** composite materials or cast iron fixed around a cable to provide mechanical protection.

One or more of these types of cable protection may be used. Cable protection consisting of freely-laid rock can be installed by a fallpipe vessel, a vessel's crane, or side dumping from a vessel. If freely-laid rock is used, the fallpipe installation method, which is the most accurate technique, will be used wherever possible. Concrete mattresses, rock bags, and grout-filled bags will likely be deployed by a vessel's crane. Half-shell pipes are expected to be installed around the cable on board the cable laying vessel prior to installing the cable.

#### 4.5.8 Cable Crossings

The ECCs will cross existing marine infrastructure, including submarine cables (see Figure 4.5-10). The Monmouth ECC could have up to 15 crossings that each export cable will need to complete, while the Atlantic ECC could have up to four crossings for each export cable.<sup>20</sup> It is also estimated that up to 10 inter-array cable crossings and up to two inter-link cable crossings may be required.

Any cable crossing will be carefully surveyed and, if the cable is still active, Atlantic Shores will develop a crossing agreement with its owner. At each crossing, before installing the Atlantic Shores cable, the area around the crossing will be cleared of any marine debris. Depending on the status of the existing cable and its location, such as burial depth and substrate characteristics, cable protection may be placed between the existing cable and Atlantic Shores' overlying cable. However, if sufficient vertical distance exists, such protection may be avoided. It is likely that the presence of an existing cable will prevent Atlantic Shores' cable from being buried to its target burial depth. In this case, cable protection may be required on top of the proposed cable at the crossing location. Following installation of the proposed cables, the cable crossing will be surveyed again.

Atlantic Shores is considering the same five types of cable protection at infrastructure crossings as described in Section 4.5.7. The dimensions of cable protection at infrastructure crossings are provided in Section 4.5.10.

If an existing cable is inactive, it will be cut and removed prior to installing Atlantic Shore's cables. Removal of the inactive cables will enable burial of Atlantic Shore's cables and avoid the need for cable protection. Where removal is not feasible, standard cable crossing techniques will be employed, which may require cable protection.

---

<sup>20</sup> The maximum number of cable crossings for each ECC accounts for the possibility that other offshore cables may be installed prior to the start of Projects' construction.

8/20/2021 | G:\Projects\21\56512021\Task\_1\Map\Fig 4.5-10\_Cable\_Crossings\_20210819.mxd

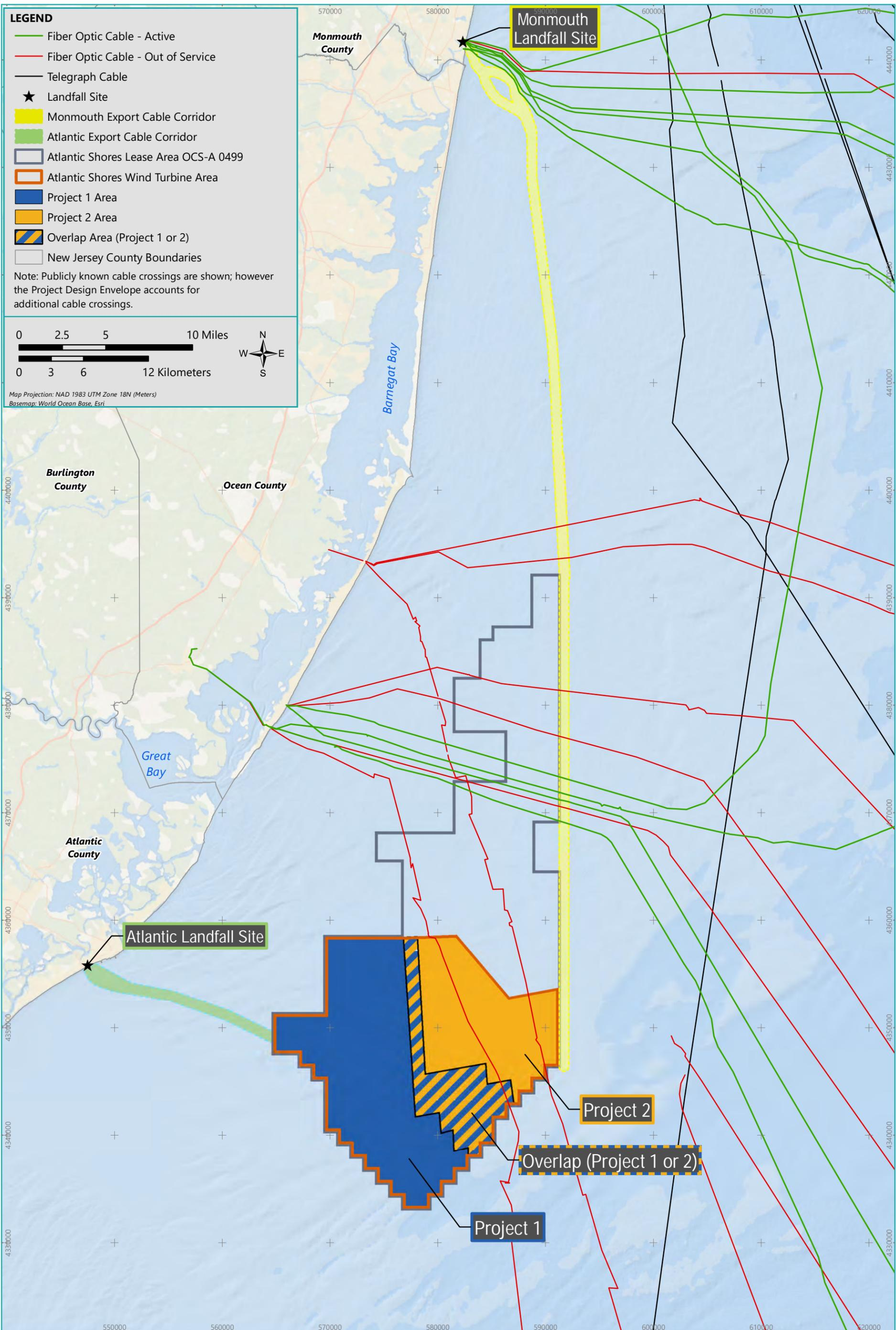

**LEGEND**

- Fiber Optic Cable - Active
- Fiber Optic Cable - Out of Service
- Telegraph Cable
- ★ Landfall Site
- Monmouth Export Cable Corridor
- Atlantic Export Cable Corridor
- Atlantic Shores Lease Area OCS-A 0499
- Atlantic Shores Wind Turbine Area
- Project 1 Area
- Project 2 Area
- Overlap Area (Project 1 or 2)
- New Jersey County Boundaries

Note: Publicly known cable crossings are shown; however the Project Design Envelope accounts for additional cable crossings.

0 2.5 5 10 Miles

0 3 6 12 Kilometers

Map Projection: NAD 1983 UTM Zone 18N (Meters)  
 Basemap: World Ocean Base, Esri

**Figure 4.5-10**  
 Cable Crossings



#### 4.5.9 Post-Construction Surveys

The precise location and burial depth of each cable will be monitored in real-time during installation activities. As-built plans will be provided to National Oceanic and Atmospheric Administration (NOAA) so the cables can be included on nautical charts; this will enable mariners to access information on the cables' locations. Following installation, Atlantic Shores will perform a post-construction survey along the cables. Monitoring of the offshore cables during O&M is further described in Section 5.1.

#### 4.5.10 Summary of Area of Potential Seabed Disturbance

##### 4.5.10.1 Export Cables

As described in the preceding sections, up to eight HVAC or HVDC export cables [the HVDC cables are bundled and installed together]) could be installed within the two ECCs. The maximum length per offshore export cable is approximately 25 mi (40 km) to the Atlantic Landfall Site and 85 mi (138 km) to the Monmouth Landfall Site. Both Projects 1 and 2 have the potential to use either ECC and may also be co-located within an ECC.

The maximum potential seabed disturbance from export cable installation is provided in Table 4.5-1. Given that a portion of the export cables will be installed within the WTA (from the WTA boundary to OSSs), Table 4.5-1 provides the maximum area of potential seabed disturbance for the export cables within the WTA as well as the ECCs.,.

Table 4.5-1 Maximum Seabed Disturbance from Export Cable Installation

<b>Installation Activity Characteristics (Maximum)</b>	<b>Atlantic Landfall Site to OSS</b>	<b>Monmouth Landfall Site to OSS</b>
Max. length per export cable	24.9 mi (40.0 km)	85.4 mi (137.5 km)
Max. total length of export cables	99.4 mi (160.0 km)	341.8 mi (550.0 km)
<b>Maximum Temporary Disturbance from Export Cable Installation</b>		
<b><i>Cable Installation Trench and Skid/Track</i></b>		
Max. depth of cable trench	9.8 ft (3.0 m)	9.8 ft (3.0 m)
Max. width of cable trench	3.3 ft (1.0 m)	3.3 ft (1.0 m)
Max. width of additional skid/track disturbance	13.1 ft (4.0 m)	13.1 ft (4.0 m)
Max. area of cable trench and skid/track disturbance	0.31 square mile (mi <sup>2</sup> ) (0.80 square kilometer [km <sup>2</sup> ])	1.06 mi <sup>2</sup> (2.75 km <sup>2</sup> )
<b><i>Pre-Pass Jetting and Multiple Burial Passes (along limited length of the cable routes)</i></b>		
Max. total length of cable requiring pre-pass jetting	5.0 mi (8.0 km)	17.1 mi (27.5 km)
Max. total length of cable requiring multiple burial passes	9.9 mi (16.0 km)	68.4 mi (110.0 km)
Max. area of additional disturbance from pre-pass jetting and subsequent passes of the cable installation tool	None	None

Table 4.5-1 Maximum Seabed Disturbance from Export Cable Installation (Continued)

Installation Activity Characteristics (Maximum)	Atlantic Landfall Site to OSS	Monmouth Landfall Site to OSS
<b>Pre-Lay Grapnel Run (along entire cable routes)</b>		
Max. depth of pre-lay grapnel run (PLGR)	1.6 ft (0.5 m)	1.6 ft (0.5 m)
Max. width of PLGR (total for 3 passes)	9.8 ft (3.0 m)	9.8 ft (3.0 m)
Max. area of additional disturbance from PLGR (for 2 passes beyond cable trench and skids/tracks)	0.12 mi <sup>2</sup> (0.32 km <sup>2</sup> )	0.42 mi <sup>2</sup> (1.10 km <sup>2</sup> )
<b>Boulder Relocation (along limited length of the cable routes)</b>		
Max. total length of boulder relocation	9.9 mi (16.0 km)	34.2 mi (55.0 km)
Max. width of displacement plow	32.8 ft (10.0 m)	32.8 ft (10.0 m)
Max. depth of displacement plow	2.6 ft (0.8 m)	2.6 ft (0.8 m)
Max. area of additional disturbance from boulder relocation (beyond cable trench, skids/tracks, and PLGR)	0.02 mi <sup>2</sup> (0.05 km <sup>2</sup> )	0.06 mi <sup>2</sup> (0.17 km <sup>2</sup> )
<b>Sand Bedform Removal (along limited length of the cable routes)</b>		
Max. total length of cables requiring sand bedform removal	19.9 mi (32.0 km)	68.4 mi (110.0 km)
Max. width of sand bedform removal		
Top of trench	98.4 ft (30.0 m)	98.4 ft (30.0 m)
Bottom of trench	49.2 ft (15.0 m)	49.2 ft (15 m)
Typical depth of sand bedform removal	3.3 ft (1.0 m)	3.3 ft (1.0 m)
Max. depth of sand bedform removal	19.7 ft (6.0 m)	19.7 ft (6.0 m)
Max. volume of sand bedforms removed <sup>a</sup>	941,724 cubic yards (yd <sup>3</sup> ) (720,000 m <sup>3</sup> )	3,237,176 yd <sup>3</sup> (2,475,000 m <sup>3</sup> )
Max. area of additional disturbance from sand bedform removal (beyond cable trench, skids/tracks, and PLGR)	0.28 mi <sup>2</sup> (0.74 km <sup>2</sup> )	0.98 mi <sup>2</sup> (2.53 km <sup>2</sup> )
<b>Anchoring/Jacking-Up</b>		
Max. total length of cables requiring anchoring	14.9 mi (24.0 km)	5.0 mi (8.0 km)
Max. area of disturbance from anchoring during cable installation <sup>b</sup>	0.41 mi <sup>2</sup> (1.06 km <sup>2</sup> )	0.14 mi <sup>2</sup> (0.35 km <sup>2</sup> )
Max. area of disturbance from jacking-up during cable splicing and HDD at the landfall sites <sup>c</sup>	0.0003 mi <sup>2</sup> (0.0008 km <sup>2</sup> )	0.0007 mi <sup>2</sup> (0.0017 km <sup>2</sup> )
<b>Maximum Temporary Disturbance from Export Cable Installation</b>		
<b>Total Temporary Disturbance from Export Cable Installation</b>		
Total max. area of temporary seafloor disturbance due to export cable installation <sup>d</sup>	1.10 mi <sup>2</sup> (2.85 km <sup>2</sup> )	2.51 mi <sup>2</sup> (6.51 km <sup>2</sup> )
Portion of temporary disturbance within WTA <sup>e</sup>	0.27 mi <sup>2</sup> (0.71 km <sup>2</sup> )	0.25 mi <sup>2</sup> (0.65 km <sup>2</sup> )
Portion of temporary disturbance within ECC <sup>f</sup>	0.83 mi <sup>2</sup> (2.14 km <sup>2</sup> )	2.26 mi <sup>2</sup> (5.86 km <sup>2</sup> )

Table 4.5-1 Maximum Seabed Disturbance from Export Cable Installation (Continued)

Installation Activity Characteristics (Maximum)	Atlantic Landfall Site to OSS	Monmouth Landfall Site to OSS
<b>Maximum Permanent Disturbance from Export Cable Installation</b>		
<b>Cable Entry Projection System</b>		
Max. # of export cable approaches to OSS	4	4
Max. length of cable entry protection system beyond scour protection <sup>9</sup>	19.7 ft (6.0 m)	19.7 ft (6.0 m)
Max. diameter of cable entry protection system	2.0 ft (0.6 m)	2.0 ft (0.6 m)
<b>Cable Protection for Infrastructure Crossings</b>		
Max. # of cable crossings	16	60
Max. area of cable protection per crossing	43,055.6 ft <sup>2</sup> (4,000.0 m <sup>2</sup> )	43,055.6 ft <sup>2</sup> (4,000.0 m <sup>2</sup> )
Max. thickness of cable protection at crossings	5.6 ft (1.7 m)	5.6 ft (1.7 m)
<b>Cable Protection for Insufficient Burial Depth (along limited length of the cables)</b>		
Max. length of cable protection	9.9 mi (16.0 km)	34.2 mi (55.0 km)
Max. width of cable protection	41.0 ft (12.5 m)	41.0 ft (12.5 m)
Max. thickness of cable protection	4.6 ft (1.4 m)	4.6 ft (1.4 m)
<b>Total Permanent Disturbance from Export Cable Installation</b>		
Total max. area of permanent seafloor disturbance for export cables	0.10 mi <sup>2</sup> (0.26 km <sup>2</sup> )	0.36 mi <sup>2</sup> (0.93 km <sup>2</sup> )
Portion of permanent disturbance within WTA	0.04 mi <sup>2</sup> (0.11 km <sup>2</sup> )	0.04 mi <sup>2</sup> (0.10 km <sup>2</sup> )
Portion of permanent disturbance within ECC	0.06 mi <sup>2</sup> (0.16 km <sup>2</sup> )	0.32 mi <sup>2</sup> (0.83 km <sup>2</sup> )
<b>Total Temporary and Permanent Seafloor Disturbance</b>		
<b>Total max. area of temporary and permanent seafloor disturbance from export cable installation</b>	<b>1.20 mi<sup>2</sup> (3.11 km<sup>2</sup>)</b>	<b>2.87 mi<sup>2</sup> (7.44 km<sup>2</sup>)</b>
<b>Portion of total seafloor disturbance within WTA</b>	<b>0.48 mi<sup>2</sup> (1.24 km<sup>2</sup>)</b>	<b>0.31 mi<sup>2</sup> (0.79 km<sup>2</sup>)</b>
<b>Portion of total seafloor disturbance within ECC</b>	<b>0.72 mi<sup>2</sup> (1.87 km<sup>2</sup>)</b>	<b>2.57 mi<sup>2</sup> (6.65 km<sup>2</sup>)</b>

Notes:

- Maximum sand bedform removal volumes are calculated based on the typical depth of sand bedform removal.
- Assumes an eight-point anchor spread with each anchor disturbing 11,840 ft<sup>2</sup> (1,100 m<sup>2</sup>) (i.e., 1,076 ft<sup>2</sup> [100 m<sup>2</sup>] for the anchor itself plus 10,764 ft<sup>2</sup> [1,000.0 m<sup>2</sup>] for the mooring system), giving a total disturbance area of 94,722.3 ft<sup>2</sup> (8,800.0 m<sup>2</sup>) each time the vessel repositions its anchors (assumed every 656.2 ft [200.0 m]).
- Assumes one jack-up vessel disturbing 845.4 ft<sup>2</sup> (78.5 m<sup>2</sup>) (based on a four-legged jack-up with each leg disturbing 211.3 ft<sup>2</sup> [19.6 m<sup>2</sup>]) per cable joint plus one jack-up for HDD operations per HDD conduit.
- To avoid double counting impacts, excludes the area of temporary disturbance that would be covered by cable protection.

- e) Based on an export cable length within the WTA of 10.1 mi (16.3 km) per cable for the route from the Atlantic Landfall Site and 9.3 mi (15.0 km) per cable for the route from the Monmouth Landfall Site. No boulder relocation or anchoring is anticipated to occur within the WTA.
- f) Based on an export cable length within the 0.254 of 14.8 mi (23.8 km) per cable and within the Monmouth ECC of 76.1 mi (122.5 km). All potential disturbance from boulder relocation and anchoring is assumed to occur in the ECCs.
- g) The area of disturbance from the cable entry protection system where it lays above the scour protection is accounted for in the PDE of OSS foundation parameters (see Table 4.4-2 in Section 4.4).

#### 4.5.10.2 Inter-Array and Inter-Link Cables

Atlantic Shores anticipates that up to 547 mi (880 km) of inter-array cables may be required, while up to approximately 37 mi (60 km) of inter-link cables may be needed. Project 1 and Project 2 will each have a maximum of 273.5 mi (440 km) of inter-array cables and up to approximately 18.6 mi (30 km) of inter-link cables. The maximum potential seabed disturbance from installation of inter-array and inter-link cables is provided in Table 4.5-2.

Table 4.5-2 Maximum Seabed Disturbance from Inter-Array and Inter-Link Cable Installation

Installation Activity Characteristics (Maximum)	Project 1		Project 2	
	Inter-Array Cables	Inter-Link Cables	Inter-Array Cables	Inter-Link Cables
Max. total length of cable	273.4 mi (440.0 km)	18.6 mi (30.0 km)	273.4 mi (440.0 km)	18.6 mi (30.0 km)
<b>Maximum Temporary Disturbance from Cable Installation</b>				
<b>Cable Installation Trench and Skid/Track</b>				
Max. depth of cable trench	9.8 ft (3.0 m)	9.8 ft (3.0 m)	9.8 ft (3.0 m)	9.8 ft (3.0 m)
Max. width of cable trench	3.3 ft (1.0 m)	3.3 ft (1.0 m)	3.3 ft (1.0 m)	3.3 ft (1.0 m)
Max. width of additional skid/track disturbance	13.1 ft (4.0 m)	13.1 ft (4.0 m)	13.1 ft (4.0 m)	13.1 ft (4.0 m)
Max. area of cable trench and skid/track disturbance	0.85 mi <sup>2</sup> (2.20 km <sup>2</sup> )	0.06 mi <sup>2</sup> (0.15 km <sup>2</sup> )	0.85 mi <sup>2</sup> (2.20 km <sup>2</sup> )	0.06 mi <sup>2</sup> (0.15 km <sup>2</sup> )
<b>Multiple Burial Passes (along limited length of the cables)</b>				
Max. total length of cable requiring multiple burial passes	54.7 mi (88.0 km)	3.7 mi (6.0 km)	54.7 mi (88.0 km)	3.7 mi (6.0 km)
Max. area of additional disturbance from subsequent passes of the cable installation tool	None	None	None	None
<b>Pre-Lay Grapple Run (along entire cable)</b>				
Max. depth of PLGR	1.6 ft (0.5 m)	1.6 ft (0.5 m)	1.6 ft (0.5 m)	1.6 ft (0.5 m)
Max. width of PLGR (total for 3 passes)	9.8 ft (3.0 m)	9.8 ft (3.0 m)	9.8 ft (3.0 m)	9.8 ft (3.0 m)
Max. area of additional disturbance from PLGR (for 2 passes beyond cable trench and skids/tracks)	0.34 mi <sup>2</sup> (0.88 km <sup>2</sup> )	0.02 mi <sup>2</sup> (0.06 km <sup>2</sup> )	0.34 mi <sup>2</sup> (0.88 km <sup>2</sup> )	0.02 mi <sup>2</sup> (0.06 km <sup>2</sup> )

Table 4.5-2 Maximum Seabed Disturbance from Inter-Array and Inter-Link Cable Installation  
(Continued)

Installation Activity Characteristics (Maximum)	Project 1		Project 2	
	Inter-Array Cables	Inter-Link Cables	Inter-Array Cables	Inter-Link Cables
<b>Sand Bedform Removal (along limited length of the cables)</b>				
Max. total length of cables requiring sand bedform removal	27.3 mi (44.0 km)	3.7 mi (6.0 km)	27.3 mi (44.0 km)	3.7 mi (6.0 km)
<b>Sand Bedform Removal (along limited length of the cables)</b>				
Max. width of sand bedform removal	98.4 ft (30.0 m)	98.4 ft (30.0 m)	98.4 ft (30.0 m)	98.4 ft (30.0 m)
Top of trench	49.2 ft (15.0 m)	49.2 ft (15 m)	49.2 ft (15.0 m)	49.2 ft (15 m)
Bottom of trench				
Typical depth of sand bedform removal	3.3 ft (1.0 m)	3.3 ft (1.0 m)	3.3 ft (1.0 m)	3.3 ft (1.0 m)
Max. depth of sand bedform removal	19.7 ft (6.0 m)	19.7 ft (6.0 m)	19.7 ft (6.0 m)	19.7 ft (6.0 m)
<b>Sand Bedform Removal (along limited length of the cables)</b>				
Max. volume of sand bedforms removed <sup>a</sup>	1,294,871 yd <sup>3</sup> (990,000 m <sup>3</sup> )	176,573 yd <sup>3</sup> (135,000 m <sup>3</sup> )	1,294,871 yd <sup>3</sup> (990,000 m <sup>3</sup> )	176,573 yd <sup>3</sup> (135,000 m <sup>3</sup> )
Max. area of additional disturbance from sand bedform removal (beyond cable trench, skids/tracks, and PLGR)	0.39 mi <sup>2</sup> (1.01 km <sup>2</sup> )	0.05 mi <sup>2</sup> (0.14 km <sup>2</sup> )	0.39 mi <sup>2</sup> (1.01 km <sup>2</sup> )	0.05 mi <sup>2</sup> (0.14 km <sup>2</sup> )
<b>Total Temporary Disturbance from Cable Installation</b>				
Total max. area of temporary seafloor disturbance due to cable installation <sup>b</sup>	1.46 mi <sup>2</sup> (3.78 km <sup>2</sup> )	0.13 mi <sup>2</sup> (0.33 km <sup>2</sup> )	1.46 mi <sup>2</sup> (3.78 km <sup>2</sup> )	0.13 mi <sup>2</sup> (0.33 km <sup>2</sup> )
<b>Maximum Permanent Disturbance from Cable Installation</b>				
<b>Cable Entry Projection System</b>				
Max. # of cable approaches to WTGs and OSSs	282 (136 WTGs and 5 OSSs with 2 approaches)	4	200	4 (95 WTGs and 5 OSSs with 2 approaches)
Max. length of cable entry protection system beyond scour protection <sup>c</sup>	19.7 ft (6.0 m)	19.7 ft (6.0 m)	19.7 ft (6.0 m)	19.7 ft (6.0 m)
Max. diameter of cable entry protection system	2.0 ft (0.6 m)	2.0 ft (0.6 m)	2.0 ft (0.6 m)	2.0 ft (0.6 m)
<b>Cable Protection for Infrastructure Crossings</b>				
Max. # of cable crossings	5	1	5	1
Max. area of cable protection per crossing	43,055.6 ft <sup>2</sup> (4,000.0 m <sup>2</sup> )	43,055.6 ft <sup>2</sup> (4,000.0 m <sup>2</sup> )	43,055.6 ft <sup>2</sup> (4,000.0 m <sup>2</sup> )	43,055.6 ft <sup>2</sup> (4,000.0 m <sup>2</sup> )
Max. thickness of cable protection at crossings	5.6 ft (1.7 m)	5.6 ft (1.7 m)	5.6 ft (1.7 m)	5.6 ft (1.7 m)

Table 4.5-2 Maximum Seabed Disturbance from Inter-Array and Inter-Link Cable Installation (Continued)

Installation Activity Characteristics (Maximum)	Project 1		Project 2	
	Inter-Array Cables	Inter-Link Cables	Inter-Array Cables	Inter-Link Cables
<b><i>Cable Protection for Insufficient Burial Depth (along limited length of the cables)</i></b>				
Max. length of cable protection	27.3 mi (44.0 km)	1.9 mi (3.0 km)	27.3 mi (44.0 km)	1.9 mi (3.0 km)
Max. width of cable protection	41.0 ft (12.5 m)	41.0 ft (12.5 m)	41.0 ft (12.5 m)	41.0 ft (12.5 m)
Max. thickness of cable protection	4.6 ft (1.4 m)	4.6 ft (1.4 m)	4.6 ft (1.4 m)	4.6 ft (1.4 m)
<b><i>Total Permanent Disturbance from Cable Installation</i></b>				
Total max. area of permanent seafloor disturbance for inter-array and inter-link cables	0.22 mi <sup>2</sup> (0.57 km <sup>2</sup> )	0.02 mi <sup>2</sup> (0.04 km <sup>2</sup> )	0.22 mi <sup>2</sup> (0.57 km <sup>2</sup> )	0.02 mi <sup>2</sup> (0.04 km <sup>2</sup> )
<b><i>Total Temporary and Permanent Seafloor Disturbance</i></b>				
<b>Total max. area of temporary and permanent seafloor disturbance from inter-array and inter-link cable installation</b>	<b>1.68 mi<sup>2</sup> (4.35 km<sup>2</sup>)</b>	<b>0.14 mi<sup>2</sup> (0.37 km<sup>2</sup>)</b>	<b>1.68 mi<sup>2</sup> (4.35 km<sup>2</sup>)</b>	<b>0.14 mi<sup>2</sup> (0.37 km<sup>2</sup>)</b>

Notes:

- Maximum sand bedform removal volumes are calculated based on the typical depth of sand bedform removal.
- To avoid double counting impacts, excludes the area of temporary disturbance that would be covered by cable protection.
- The area of disturbance from the cable entry protection system where it lays above the scour protection is accounted for in the PDE of WTG and OSS foundation parameters (see Table 4.2-1 in Section 4.2 and Table 4.4-2 in Section 4.4).

## 4.6 Meteorological Tower and Metocean Buoys

### 4.6.1 Permanent Met Tower

A single permanent meteorological (met) tower may be installed within the WTA during construction of Project 1. Up to 4 locations for the met tower, all located within Project 1, are under consideration (see Figure 4.6-1). The foundation options for the met tower include all options under consideration for WTG foundations and the construction methodologies are assumed to be the same as those for WTG foundations (see Section 4.2). There is sufficient conservatism in the total estimates of seafloor disturbance from WTG foundation installation to account for the impacts from the met tower's installation (see Section 4.11).

8/20/2021 | G:\Projects\2\WV\56512021\Task\_1\Map\Fig\_4.6-1\_Met\_Tower\_Met\_Export\_Buoy\_Locations\_20210819.mxd

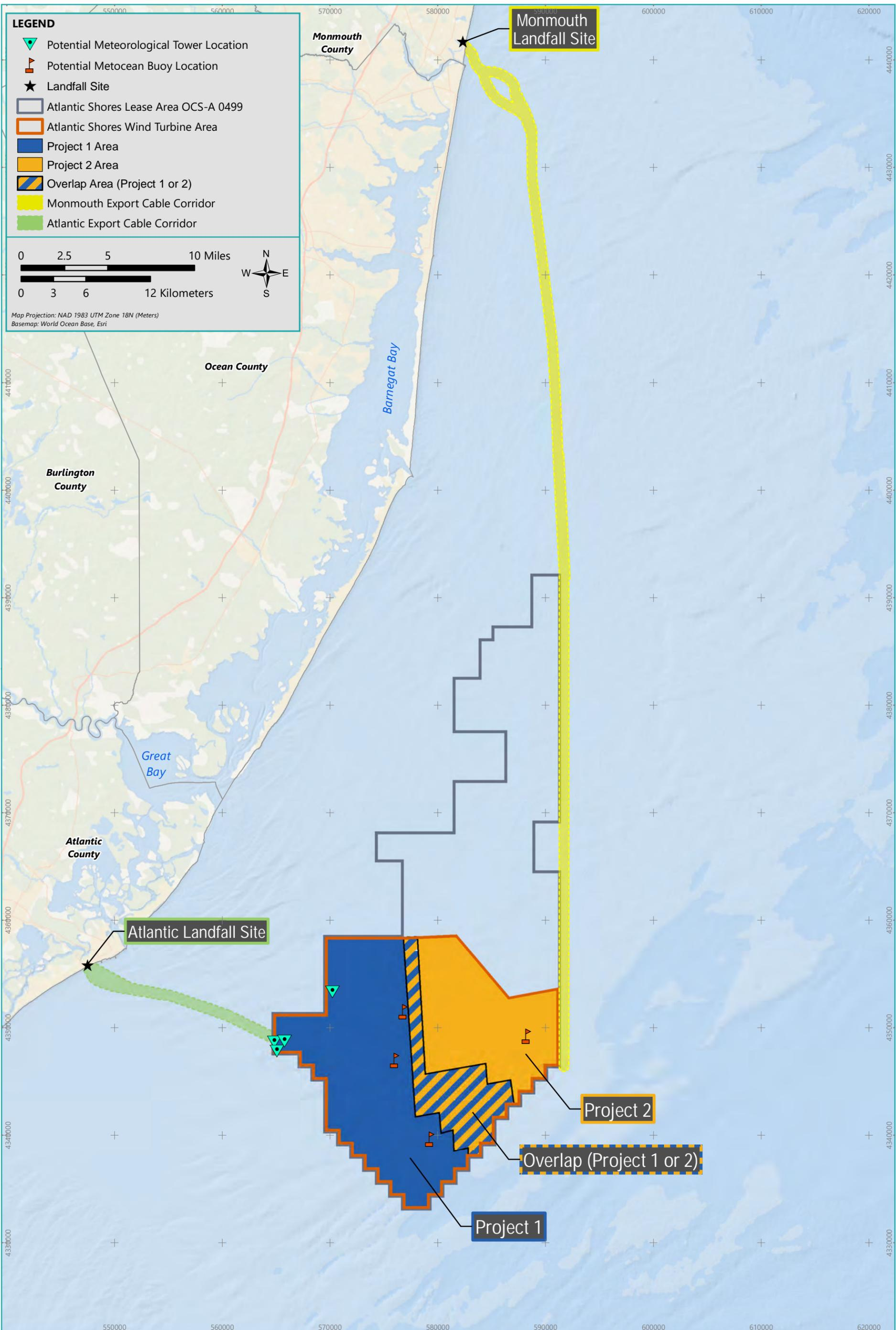

The maximum height of the met tower will not exceed 16.5 ft (5 m) above the hub height of the largest WTG installed. Therefore, it is conservative to assume the maximum height of the met tower will be 590.6 ft (180 m) above MSL. The met tower itself is expected to be composed of square lattice consisting of tubular steel. It will be equipped with a deck estimated to be approximately 50 ft by 50 ft (15 m by 15 m) mounted at approximately the same elevation as the interface between the WTGs and their foundations. A schematic of a representative met tower is provided as Figure 4.6-2.

#### 4.6.2 Temporary Metocean Buoys

In addition to the met tower, up to four temporary meteorological and oceanographic (metocean) buoys may be installed and kept in place during construction to monitor weather and sea state conditions: three in Project 1 and one in Project 2. The metocean buoys are expected to be anchored to the seafloor using a steel chain connected to a steel chain weight on the seafloor. An additional bottom weight associated with a water level sensor may also be connected to the buoys' mooring system. The maximum area of temporary seafloor disturbance from each buoy's anchor (including anchor sweep) is anticipated to be approximately 0.005 mi<sup>2</sup> (0.013 km<sup>2</sup>), with a maximum depth of disturbance of 3.3 ft (1.0 m). The potential locations for the metocean buoys are shown on Figure 4.6-1 and an indicative schematic of a metocean buoy is provided as Figure 4.6-3. The buoys will be decommissioned in accordance with 30 CFR Part 585, Subpart I at the end of Project construction.

#### 4.7 Landfall Sites

The offshore-to-onshore transition between export cables within the ECC to onshore interconnection cables will occur at two landfall sites.

As shown on Figure 1.1-2, the southernmost ECC (the Atlantic ECC) leads to the Atlantic Landfall Site, from which onshore interconnection cables will connect to the Cardiff point of interconnection (POI). The Atlantic Landfall Site is located near the end of Sovereign Avenue within Atlantic City in Atlantic County, New Jersey (see Figure 4.8-1). It is anticipated that the underground transition vaults (one per export cable) will be located at the eastern terminus of Sovereign Avenue under a parking area adjacent to the Atlantic City Boardwalk.

The northernmost ECC (the Monmouth ECC) leads to the Monmouth Landfall Site, from which onshore interconnection cables will connect to the Larrabee POI. As shown in Figure 4.8-2, the Monmouth Landfall Site is located within the Borough of Sea Girt in Monmouth County, New Jersey at the Army National Guard Training Center (NGTC). The underground transition vaults (one per export cable) will be located in the southeast corner of the NGTC in a previously disturbed area.



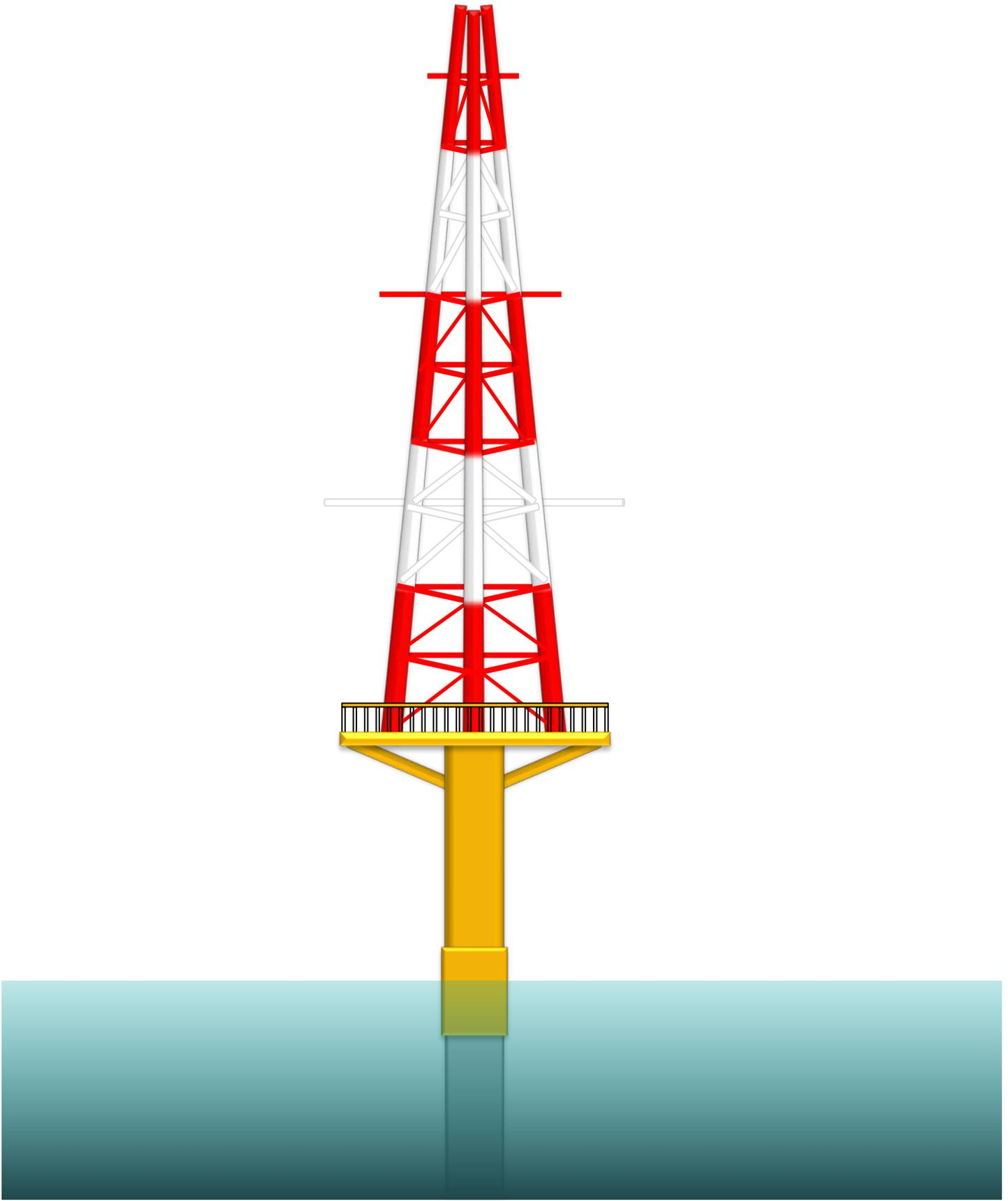

# SEAWATCH WIND LIDAR BUOY – MOORING

WIND LIDAR BUOY

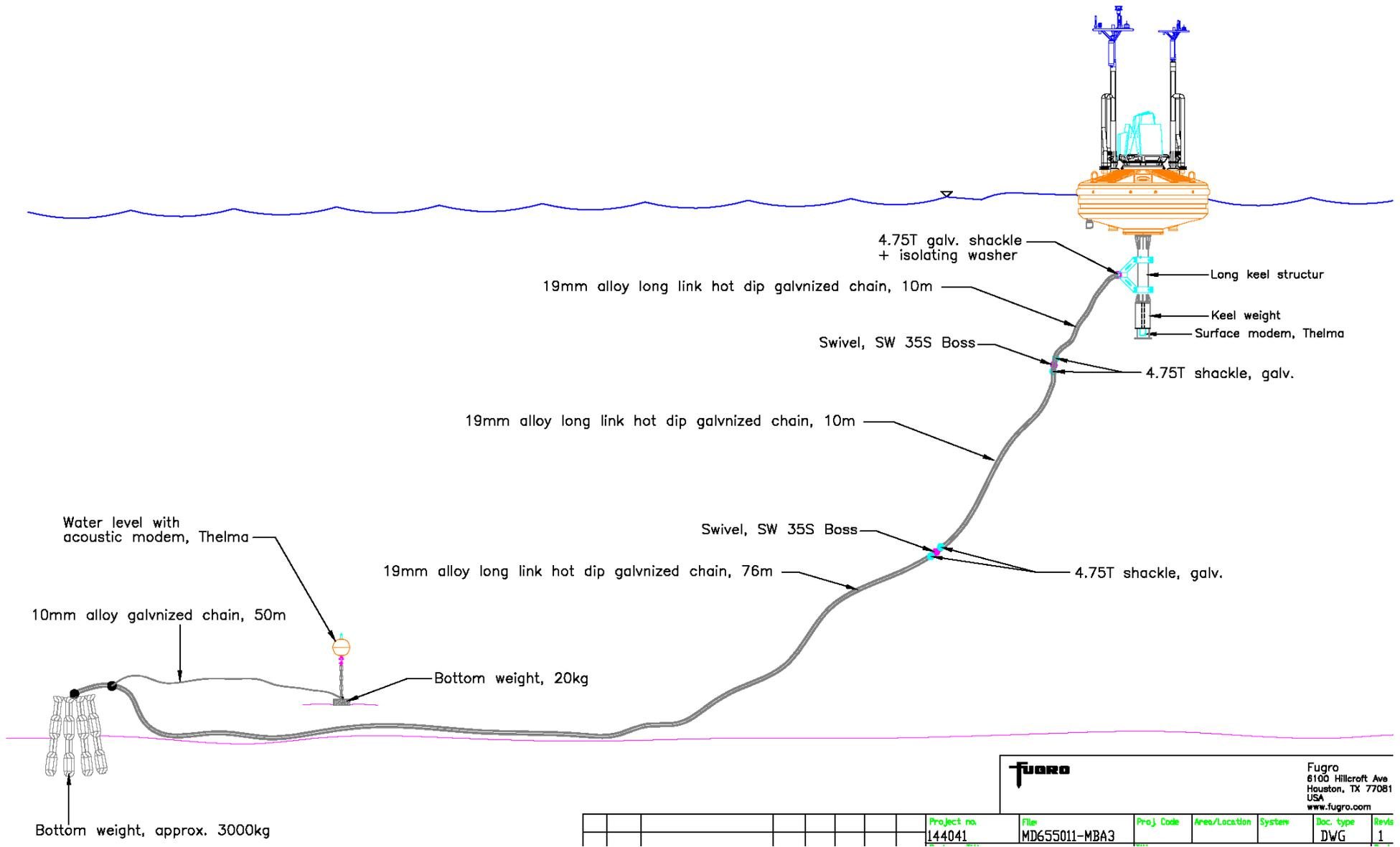

#### 4.7.1 Landfall Site Construction Activities

The offshore-to-onshore transition is proposed to be accomplished using HDD, a trenchless method that will avoid nearshore impacts as well as impacts directly along the shoreline. HDD, in comparison to trenching, also results in a deeper burial depth for cables in the nearshore environment, facilitating sufficient burial over the life of the Projects and decreasing the likelihood that cables will become exposed over time.

An HDD bore will be completed for each of the export cables coming ashore, so each cable will be contained within its own HDD conduit. Up to two additional spare HDD conduits may be installed at each landfall site for a total of six HDD conduits at each landfall site. To support HDD activities, Atlantic Shores will establish an onshore staging area at each landfall site.

Engineering for the HDD trajectories at each landfall site is currently underway. Final design of the landfall site HDDs will be provided as part of the Project's Facility Design Report (FDR) and Fabrication and Installation Report (FIR). At both sites, HDD will either be initiated or exit landward of the beach to avoid impacts to the beach. At the Atlantic Landfall Site, the HDD trajectory for each of the cables is expected to be approximately 1,969 ft (600 m) long. At the Monmouth Landfall Site, the HDD trajectory for each of the cables is expected to be approximately 3,281 ft (1,000 m) long. At each landfall site, the depth of HDD is approximately 16 to 131 ft (5 to 40 m) below the seabed.

The landfall site HDD will consist of the following steps:

- 1. Excavation of entrance pit and exit pit:** Onshore, each HDD path will originate or terminate in an excavated pit that is approximately 10 ft by 13 ft (3 m by 4 m) located at the landfall site's onshore staging area. The excavated pit will also serve to contain drilling fluid. This fluid is a slurry of bentonite (an inert, non-toxic clay) and water that lubricates the drill head and extracts excavated material from the bore hole. At the offshore HDD entrance/exit location, a shallow area of up to approximately 66 ft by 33 ft (20 m by 10 m) will be excavated. A backhoe dredge may be required to complete the excavation and a cofferdam (or similar method) of approximately the same size as the excavated pit may be utilized. The need for a cofferdam (or similar) will depend on the results of marine surveys conducted near the landfall sites, the depth of burial, and the direction of HDD. A temporary offshore platform (i.e., jack-up barge) may be needed to support the HDD drilling rig; the seabed disturbance from jacking-up during HDD activities is included in Table 4.5-1.
- 2. Drilling of pilot hole:** An approximately 12.4-in (315-mm) pilot hole will be drilled between the pit at the onshore staging area and the offshore HDD exit/entrance pit in an arcing fashion beneath the shoreline and nearshore zone. If HDD is initiated onshore, when the pilot hole exits the seabed, the contractor may use water to carry drill cuttings

back to the approach pit rather than drilling fluids in order to avoid release of clay to the water column (even though bentonite is a natural substance that poses little to no risk to the marine environment).

- 3. Reaming and conduit insertion:** The drill will be equipped with a larger cutter head that will enlarge the pilot hole in preparation for insertion of a high-density polyethylene (HDPE) or polyvinyl chloride (PVC) conduit. The same drill head can pull the plastic HDD conduit through the enlarged bore hole.
- 4. Cable insertion:** Following installation of the conduit, the export cable will be inserted into the opening at the seabed and pulled through the conduit towards shore. A cofferdam (or similar method) may be used during insertion of the cable. If used, Atlantic Shores anticipates that the cofferdam will be approximately 98.4 ft by 26.2 ft (30 m by 8 m). Once the export cables are installed into the HDD conduit, the end of the conduit exposed on the seabed will then be fully buried, possibly by divers using hand-jets.
- 5. Disposal of drill cuttings:** Drilling the HDD trajectory will produce a mixture of drill cuttings from the bore hole, water, and bentonite clay (used to lubricate and cool the drill bit). This mixture will be collected on-site and filtered to separate solids from fluids, which will enable reuse of the drilling fluid. Drill cuttings and excess drill fluids are typically classified as clean fill material, and it is anticipated they will be disposed of at an appropriate upland facility such as a local landfill, a gravel pit, or other facility permitted to take such material.
- 6. Pull-back to transition vaults:** Cables installed through the HDD conduit will be pulled into onshore transition vaults, where they will be split into separate onshore cables. The transition vaults at the landfall site will be approximately 11.5 ft wide by 46 ft long by 14.8 ft deep (3.5 m wide by 14 m long by 4.5 m deep). It is anticipated that the transition vaults will also include fiber optic splice boxes.
- 7. Site restoration:** The onshore HDD staging areas will be restored to be consistent with existing conditions, while the transition vaults will be entirely underground except for at-grade manhole covers.

Based on local permit requirements, Atlantic Shores expects that onshore construction will be seasonally restricted to occur outside of the period from Memorial Day to Labor Day. The HDD construction schedule will be developed in accordance with municipal noise ordinances. Certain activities, such as conduit pull-in, cannot stop once they are started, so work may need to continue into the night or occur on the weekend. Atlantic Shores will coordinate with municipal officials to finalize the onshore construction schedule and hours.

## 4.8 Onshore Interconnection Cables and Points of Interconnection

From the Monmouth Landfall Site and Atlantic Landfall Site, onshore interconnection cables will travel underground primarily along existing roadways, utility right-of-way (ROW), and/or along bike paths to proposed onshore substations described in Section 4.9. Easements and ROW for

private parcels will be acquired where necessary. From the proposed onshore substations, the onshore interconnection cables will continue to the proposed POIs at the existing Larrabee Substation and existing Cardiff Substation for interconnection to the electrical grid.

#### 4.8.1 Cardiff Onshore Interconnection Cable Route

The Cardiff Onshore Interconnection Cable Route is an approximately 12 mi (19 km) underground transmission route that largely uses existing linear infrastructure corridors to connect the Atlantic Landfall Site to the existing Cardiff Substation POI (see Figure 4.8-1). See Section 4.7 for a description of the Atlantic Landfall Site.

From the Atlantic Landfall Site, the Cardiff Onshore Interconnection Cable Route continues northwest under Sovereign Avenue through urban residential and commercial areas via open trenching to the western end of the roadway at the intracoastal waterway. HDD is expected to be used to cross the waterway to Bader Airfield, and again from Bader Airfield under Turtle Gut and Great Thoroughfares to the mainland. The route will then run parallel to U.S. Route 40 for approximately 1.5 mi (2.4 km) where the route will transition into a railroad ROW that contains an existing 69 kV Atlantic City Electric (ACE) transmission line. The route continues northwest along this corridor for approximately 4.5 mi (7.2 km) through the Town of Pleasantville to just west of the Garden State Parkway near the Shore Mall. Both the preferred and alternative sites for the Projects' proposed onshore substation are located just west of the Garden State Parkway crossing and are described in Section 4.9. At this point the railroad ROW transitions to the Atlantic County Bikeway East and the route follows this ROW for approximately 3.0 mi to English Creek Road. The route then turns north along English Creek Road for 0.5 mi (0.8 km) to the existing ACE 230 kV transmission ROW which the route follows for 0.3 mi (0.5 km) to the Cardiff Substation POI.

The Cardiff Substation POI is owned by ACE and is operated at 230 kV. Modifications to the POI will be required to accommodate the interconnection of the Projects. The scope of the required modifications will be determined upon completion of the Facilities Study Report by ACE and the Pennsylvania-New Jersey-Maryland Interconnection (PJM), which is expected to be available in spring 2022. The scope of modifications at the POI may range from expanding the existing substation by adding additional breaker bay(s) to upgrading the existing high voltage section of the substation to a breaker and a half configuration. ACE will be responsible for the design and construction of the required upgrades on the existing electrical grid, including the upgrades at Cardiff Substation.

To support construction of the Cardiff Onshore Interconnection Cable Route, the Project Companies will develop a Traffic Management Plan (TMP) to avoid and minimize traffic impacts and will adhere to seasonal construction restrictions near the shoreline (see Section 4.8.3). The use of specialty installation techniques, most likely either HDD or pipe jacking (see Section 4.8.3), will also be used to avoid and minimize traffic impacts, particularly at the following locations:

- Cloverleaf at the Atlantic City High School;
- a former railroad tunnel crossing the Garden State Parkway; and
- the Route 40 crossing.

8/20/2021 | G:\Projects\AV\5651\2021\Task\_1\Map\Fig 4-8-1\_Onshore\_Project\_Route\_Cardiff\_20210819.mxd



Map Projection: NAD 1983 UTM Zone 18N  
Basemap: Nearmap Aerial, March 2020

**LEGEND**

- ★ Atlantic Landfall Site
- Cardiff Onshore Interconnection Cable Route
- Existing Cardiff Substation (Point of Interconnection)
- Atlantic Export Cable Corridor
- Proposed Onshore Substation Site (Preferred)
- Proposed Onshore Substation Site (Alternative)
- Municipality

**Figure 4.8-1**  
Atlantic Landfall Site, Cardiff Onshore Interconnection Cable Route, and Onshore Substation Sites Atlantic County, New Jersey

The Cardiff Onshore Interconnection Cable Route also includes a number of wetlands and waterway crossings. Techniques such as HDD or jack-and-bore methodologies are expected to be used to avoid impacts to these resources (see Section 4.1 Wetlands and Waterbodies of Volume II). HDD, jack-and-bore, and pipe jacking methodologies are described in Section 4.8.3.

#### 4.8.2 Larrabee Onshore Interconnection Cable Route

The Larrabee Onshore Interconnection Cable Route is an approximately 12 mi (19 km) underground transmission route that largely uses existing linear infrastructure corridors to connect the Monmouth Landfall Site to the existing Larrabee Substation POI (see Figure 4.8-2). See Section 4.7 for a description of the Monmouth Landfall Site.

From the Monmouth Landfall Site, the Larrabee Onshore Interconnection Cable Route continues west along Sea Girt Avenue through suburban residential areas to a shopping center at the corner of Route 35 and Sea Girt Avenue, approximately 1.5 mi (2.4 km). The route then turns southwest along the southern edge of the shopping center and runs south along the Route 35 ROW to a currently vacant shopping center. The route then turns northwest and follows the Edgar Felix Memorial Bikeway for approximately 2.5 mi (4.0 km) to Hospital Road. The route then follows Hospital Road to the northeast to Atlantic Avenue (County Route 524). The route travels west along County Route 524 for approximately 2 mi (3.2 km) to the I-195 ROW. The route then runs along the New Jersey Department of Transportation (NJDOT) ROW for approximately 0.75 mi (1.2 km) to the County Route 547/I-195 interchange. From this point, the route turns south and follows County Route 547 approximately 4 mi (6.4 km) to the Larrabee Substation POI.

The Larrabee Substation POI is owned by Jersey Central Power & Light (JCP&L) and is operated at 230 kV. Modifications to the POI will be required to accommodate the interconnection of the Projects. The scope of the required modifications will be determined upon completion of the Facilities Study Report by the JCP&L and PJM, which is expected to be available in fall 2021. The scope of modifications is expected to include upgrading the existing substation by adding additional breaker bay(s). JCP&L will be responsible for the design and construction of the required upgrades on the existing electrical grid, including the upgrades at Larrabee Substation.

To support construction of the Larrabee Onshore Interconnection Cable Route, the Atlantic Shores Project Companies will develop a TMP to avoid and minimize traffic impacts and will adhere to seasonal construction restrictions near the coast. The use of specialty installation techniques, most likely either HDD or pipe jacking (see Section 4.8.3), will also avoid and minimize traffic impacts, particularly at the following locations:

- the Seashore New Jersey Transit Line crossing;
- the Route 34 overpass (while on the bike path);
- the Intersection of Lakewood-Allenwood Road and County Road 524; and
- the Garden State Parkway crossing.

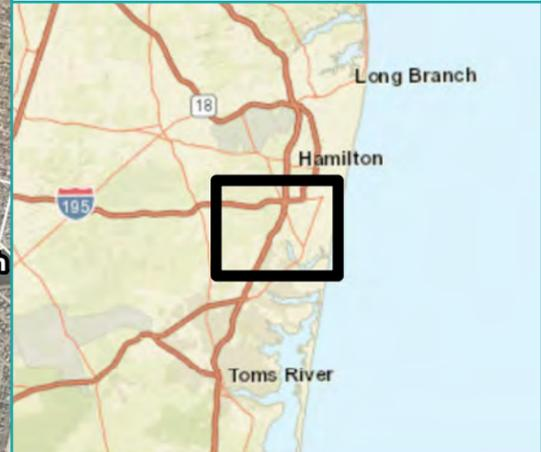
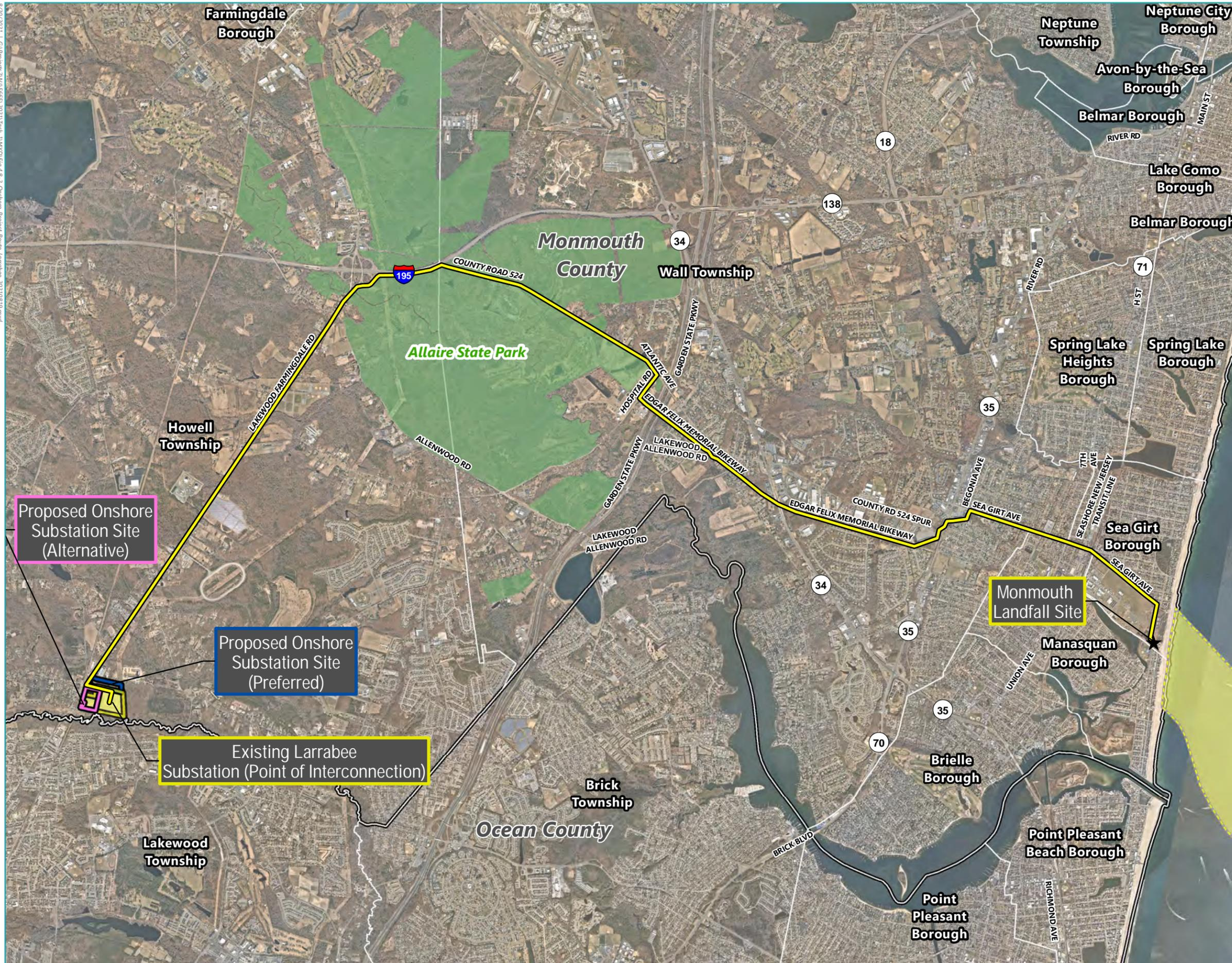

Map Projection: NAD 1983 UTM Zone 18N  
Basemap: Nearmap Aerial, March 2020

- LEGEND**
- ★ Monmouth Landfall Site
  - Larrabee Onshore Interconnection Cable Route
  - Existing Larrabee Substation (Point of Interconnection)
  - Monmouth Export Cable Corridor
  - Proposed Onshore Substation Site (Preferred)
  - Proposed Onshore Substation Site (Alternative)
  - Allaire State Park
  - Municipality
  - County

Proposed Onshore Substation Site (Alternative)

Proposed Onshore Substation Site (Preferred)

Existing Larrabee Substation (Point of Interconnection)

Monmouth Landfall Site

**Figure 4.8-2**

Monmouth Landfall Site, Larrabee Onshore Interconnection Cable Route, and Onshore Substation Sites Monmouth County, New Jersey



The Larrabee Onshore Interconnection Cable Route also includes a number of wetlands and waterway crossings. Techniques such as HDD or jack-and-bore methodologies, which are described in Section 4.8.3, are expected to be used to avoid impacts to these resources (see Section 4.1 Wetlands and Waterbodies of Volume II).

### 4.8.3 Cable Design and Construction Activities

Either HVAC or HVDC technology will be used for the Projects' onshore transmission. HVAC cables will involve three single-core cables per circuit, with cables having a water-tight design suitable for installation within a duct bank. If HVAC technology is utilized, each route could contain up to four circuits, for a total of up to 12 onshore interconnection cables and four fiber optic cables. Voltage of these onshore HVAC cables will be between 230 to 275 kV. HVDC cables will involve two single-core cables per cable circuit. If HVDC technology is utilized, each route will contain one circuit consisting of two 320 to 525 kV onshore interconnection cables and up to two fiber optic cables.

Regardless of the type of cable, the onshore interconnection cables will be contained within a buried concrete duct bank, with individual cables residing in conduits composed of HDPE or PVC. The duct bank will be up to 13.1 ft (4.0 m) wide and 8.2 ft (2.5 m) deep. Onshore interconnection cables will typically require splices every 1,640 to 3,280 ft (500 to 1,000 m). At each splice location, a concrete splice vault will be installed. Typical dimensions of a splice vault will be up to 8 ft (2.5 m) wide, 26 ft (8 m) long, and 5 ft (1.5 m) deep.

Installation of the concrete duct bank for onshore interconnection cables will typically be accomplished via open trenching, although some specialty techniques are anticipated at unique features such as busy roadways, wetlands, and waterbodies. During typical open trenching for installation of the onshore interconnection cables, the trench will be up to 14.8 ft (4.5 m) wide by 11.5 ft (3.5 m) deep. For the splice vaults (where required), the trench will be up to 12 ft (3.7 m) wide and 9 ft (2.7 m) deep. Typical cover over the buried duct bank (e.g., along roadway ROWs) will be approximately 3 ft (0.9 m), though maximum coverage over the top of the cable conduits could be up to 30 ft (9 m) in some specialty installation scenarios.

Specialty installation techniques are trenchless techniques that avoid surface disturbance and hence can avoid impacts to busy roadways, wetlands, waterbodies, or existing developments or features. These specialty techniques primarily include:

- **Horizontal directional drilling:** HDD is typically used to cross beneath relatively wide features such as interstate highways and waterbodies. As described in the context of the offshore-to-onshore transition (see Section 4.7.1), HDD commonly involves drilling a hole in an arc under the surface feature, then enlarging that hole and pulling either a large PVC or HDPE casing or several smaller PVC or HDPE conduits (in a bundle) back through the bore hole.

- **Pipe jacking:** In this method, a casing pipe originating in a jacking shaft is driven through the soil by powerful hydraulic jacks to excavate a tunnel that leads to a receiving shaft on the opposite side of the obstacle being avoided on the surface. This method results in a flexible, structural, watertight, and finished conduit for the installation of cables.
- **Jack-and-bore:** This trenchless crossing technique is used to install a casing beneath the surface feature being avoided. Relative to HDD, jack-and-bore is typically used for shorter crossings (less than approximately 200 ft [61 m]), such as those under streams or highways. A jack-and-bore is performed by excavating a bore pit and a receiving pit, located on opposite sides of the obstacle. Drilling and jacking activities are initiated from the bore pit, while the steel or concrete casing is driven into the receiving pit. As a borehole is drilled, the casing is pushed into the borehole. After the casing is in place, it is cleaned, and then smaller HDPE or PVC conduits are installed inside the casing.

Locations where these specialty techniques may be utilized are described in Sections 4.8.1 and 4.8.2.

Onshore construction hours will adhere to local noise ordinances. While Atlantic Shores is not anticipating significant nighttime work, any nighttime work deemed necessary will be coordinated with the local authorities. The Atlantic Shores Project Companies will develop a TMP to avoid and minimize traffic- and transportation-related impacts during construction. The TMP will be reviewed and approved by the NJDOT for the I-195 corridor and will also pertain to County and local roads. Best management practices (BMPs) for the TMP are expected to include traffic control measures such as signage, police details, lane closures, and detours, among others.

Atlantic Shores is proposing to adhere to seasonal construction restrictions for certain portions of the onshore interconnection cable routes to avoid impacts during peak usage. For the Cardiff Onshore Interconnection Cable Route between the Atlantic Landfall Site and Pleasantville, no onshore construction will occur during the summer (generally from Memorial Day to Labor Day), subject to ongoing coordination with local authorities. Aside from busy summer traffic, these roads also function as a coastal evacuation route so this seasonal restriction will avoid any interference with that important function. For the Larrabee Onshore Interconnection Cable Route, no summer construction will occur from the Monmouth Landfall Site, west of the Garden State Parkway, to where the route exits the bike path near Allaire State Park at Hospital Road (subject to ongoing coordination with local authorities). This restriction will minimize traffic and recreational disruptions.

Construction laydown areas have not yet been identified, but Atlantic Shores anticipates they will either be paved areas or will be locations already utilized for similar activities. As such, construction laydown is not expected to require new ground disturbance.

## 4.9 Onshore Substations

The Projects will require two onshore substations (one for each onshore POI). At each onshore substation, transmission voltage will be stepped up or stepped down in preparation for interconnection to the electrical grid at either the existing Cardiff Substation or Larrabee Substation. As shown on Figure 4.8-1 and Figure 4.8-2, as part of the PDE, Atlantic Shores has identified a preferred and an alternative onshore substation site along each of the Cardiff and Larrabee Onshore Interconnection Cable Routes.

From the proposed Cardiff onshore substation, onshore interconnection cables will continue to the existing Cardiff Substation POI in Egg Harbor Township. From the proposed Larrabee onshore substation, onshore interconnection cables will continue to the existing Larrabee Substation in Howell.

### 4.9.1 Description of Onshore Substation Sites

Two substation sites along the Cardiff Onshore Interconnection Cable Route are included in the PDE. The preferred onshore substation site is located on Shore Mall Road in Egg Harbor Township (see Figure 4.9-1). The site currently consists of a commercial shopping center, which has been partially demolished. The preferred onshore substation is proposed to be constructed within a 22-acre (0.09-km<sup>2</sup>) portion of the parking lot west of the existing shopping center. The alternative onshore substation site is also located within a commercial shopping center that is situated immediately east of U.S. Route 40 and west of the Garden State Parkway in Egg Harbor Township (see Figure 4.9-1). The onshore substation on this alternative site would also be constructed within a portion of the parking lot.

Two onshore substation sites along the Larrabee Onshore Interconnection Cable Route are included in the PDE. The preferred onshore substation site is located at the corner of County Road 547 (Lakewood Farmingdale Road) and Randolph Road in Howell Township and is adjacent to the Larrabee POI property to the north (see Figure 4.9-2). The site is currently used for an active mulching business. The alternative onshore substation site is located along County Road 547 in Howell Township and is adjacent to the Larrabee POI property to the west (see Figure 4.9-2). This alternative site consists of a junk yard, mixed forest, and transmission line ROW.

None of the potential onshore substation sites are within a designated floodplain or other flood hazard area or contain wetland resources. The onshore substation sites are all zoned for commercial and/or industrial uses and are therefore appropriate sites for the onshore substation.

### 4.9.2 Onshore Substation Design and Construction

The onshore substations may use either an air-insulated switchgear design or a gas-insulated switchgear design pending the substations' final detailed design. The substation design and specific equipment will depend on whether the onshore interconnection cables are HVAC or

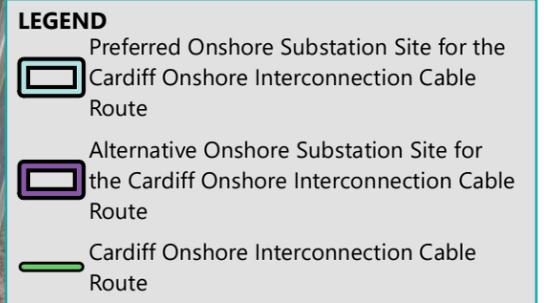
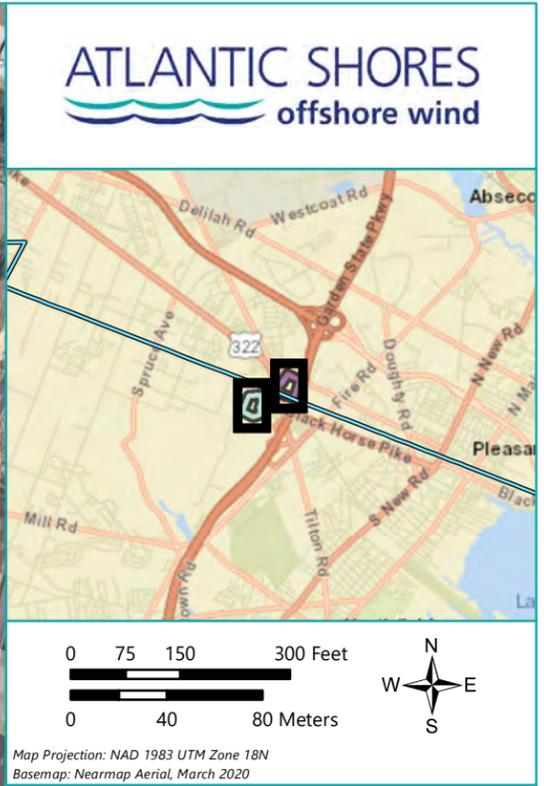

**Figure 4.9-1**  
Onshore Substation Sites for the Cardiff Onshore Interconnection Cable Route

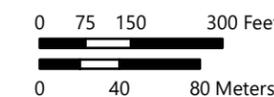
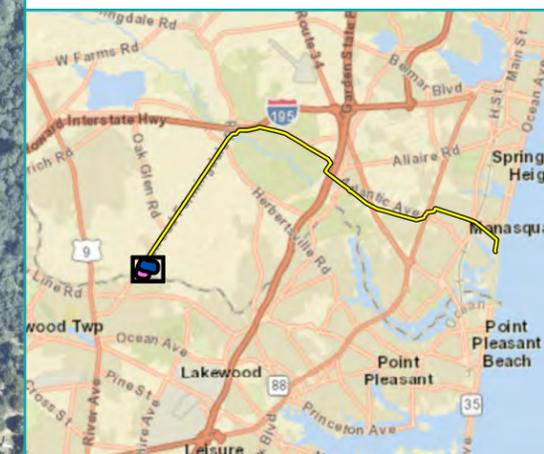

Map Projection: NAD 1983 UTM Zone 18N  
Basemap: Nearmap Aerial, July 2020

**LEGEND**

-  Preferred Onshore Substation Site for the Larrabee Onshore Interconnection Cable Route
-  Alternative Onshore Substation Site for the Larrabee Onshore Interconnection Cable Route
-  Larrabee Onshore Interconnection Cable Route
-  Municipality
-  County



**Figure 4.9-2**

Onshore Substation Sites for the Larrabee Onshore Interconnection Cable Route

HVDC. If HVAC, each onshore substation will include up to four power transformers, static synchronous compensators (STATCOMs), shunt reactors, service station transformers, harmonic filter banks, and a substation control building. If HVDC, each onshore substation will include one transformer arranged in three single-phase transformers and a control building.

Full-volume containment will be provided for major oil-containing equipment such as oil-filled transformers and reactors (as required by applicable industry standards) and could be comprised of individual containment systems (pits) or a central collection system with a pump. Any oil containment system will be sized to contain the oil in a single piece of equipment plus rainwater, melted snow, or washdown sized in accordance with applicable industry standards. Indoor lead-acid batteries for use on the 125 volts direct current (VDC) control system will also be outfitted with spill containment and absorbent mats.

Construction activities for each onshore substation will include:

- surveying;
- land clearing and rough grading and fencing;
- trenching and excavation (for ground grid, equipment foundations, and cable and conduit trenches/duct banks);
- installation of equipment foundations;
- installation of substation equipment;
- wiring and connections;
- final grading;
- commissioning;
- energization; and
- system testing.

Regardless of which potential onshore substation sites are utilized, the parcel may be disturbed during clearing and grading. Some trees may also require removal. Estimates of grading and tree clearing areas are provided in Table 4.9-1.

Table 4.9-1 Onshore Substation Parcel Dimensions

Dimension	Cardiff Onshore Substation		Larrabee Onshore Substation	
	Preferred Site	Alternate Site	Preferred Site	Alternate Site
Parcel Size	38.5 acres (0.156 km <sup>2</sup> )	23.9 acres (0.097 km <sup>2</sup> )	10.2 acres (0.041 km <sup>2</sup> )	14.6 acres (0.059 km <sup>2</sup> )
Area of Ground Disturbance	21.6 acres (0.087 km <sup>2</sup> )	23.9 acres (0.097 km <sup>2</sup> )	10.2 acres (0.041 km <sup>2</sup> )	14.6 acres (0.059 km <sup>2</sup> )
Area of Tree Clearing	Less than 0.25 acres (0.001 km <sup>2</sup> )	0.0 acres (0.0 km <sup>2</sup> )	3.0 acres (0.012 km <sup>2</sup> )	4.0 acres (0.016 km <sup>2</sup> )

A crane may be used to erect equipment and poles, to set major substation equipment (e.g., transformers, reactors, STATCOMs, harmonic filters, buswork, switchgear, breakers, switches, pre-fabricated buildings) onto foundations, and to move construction equipment (e.g., storage containers, offices, welders, generators, cable reels, cable pullers) around the site.

General substation lighting will be manually engaged on an as-needed basis if examination of equipment occurs at night. The expected use of general substation lighting will be daily during construction, start-up, and commissioning, and about three times a year during normal operations. Light fixtures will be light-emitting diode (LED) floodlights mounted on dedicated poles or lightning masts (likely 40 to 50 ft [12 to 15 m] high) to illuminate the general substation area. Illumination levels are expected to be no more than 22 lux (2 foot-candle [fc]). Any nighttime lighting for repairs or detailed inspections would be on an as-needed basis. This should be infrequent.

In addition to general substation lighting, one photocell-controlled pole-mounted LED streetlight-style fixture will be placed at the entrance gate. The fixture will be hooded to minimize glare and off-site spillover. Light fixtures will also be placed at entrance doors to the substation control building and other buildings. These fixtures will be wall-mounted and equipped with hoods to direct and limit the illumination. Atlantic Shores will coordinate with local officials to ensure the lighting scheme complies with any applicable municipal requirements.

During construction, a job-site safety program will be implemented to prevent public access to the construction site. Once the onshore substation is operational, a security plan will control site access by employing fencing (with earth grounding), screening barriers, camera systems, signage, and physical barriers. Existing vegetative buffers will be enhanced (only native vegetative species will be used) and setback, landscaping, buffering, screening, and/or lighting will be provided along exposed sides of the site. Atlantic Shores expects to coordinate with local authorities regarding the use of vegetative buffers at the onshore substations. A stormwater management system will

be designed for the onshore substation sites and will include low-impact development (LID) strategies (e.g., grass water quality swales to capture and convey site runoff, deep sump catch basin(s) to pretreat surface runoff, etc.) designed to capture, treat, and recharge stormwater runoff.

## 4.10 Proposed Construction Vessels, Vehicles, and Aircraft

The following discussion summarizes the vessels, vehicles, and aircraft expected to be used during offshore and onshore construction. Vessels, vehicles, and aircraft intended for use O&M activities are described in Section 5.6.

### 4.10.1 Offshore Construction

Construction of the offshore portion of the Projects will require use of many different types of vessels. Some of these vessels are typical ocean-going vessels, while others are purpose-built to perform specific tasks related to construction of offshore wind and/or buried cable installation. Alongside these vessels, helicopters are sometimes used for crew transfer operations and may also be used for visual inspection of equipment while vessels continue with installation activities. Atlantic Shores may also use fixed-wing aircraft to support environmental monitoring and mitigation.

Offshore construction will be divided into different campaigns including foundation installation, scour protection installation, OSS installation, WTG installation, inter-array cable installation, inter-link cable installation (if needed), and export cable installation. While performing construction tasks, vessels may anchor, jack-up, or maintain their position using DP systems. DP systems use a continually-adjusting propulsion system to keep the vessel steady in a single location. Jack-up vessels have legs that lower into the seabed and brace the vessel as it elevates above sea level, where it can safely perform operations in a stable, elevated position.

Atlantic Shores has not yet selected the specific vessels that will carry out construction activities. For the purposes of this Construction and Operations Plan (COP), representative vessel types are presented rather than specific vessels, and vessel specifications such as length, width, and speed are based on typical ranges for each type of vessel. Because the number of vessels and the number of vessel trips depend on the specific vessels used, estimates were generated using sample vessels and preliminary Project plans. Currently anticipated vessel types are shown in Table 4.10-1.

Currently, maximum estimates for the total number of vessels required for any single offshore construction activity range from two vessels for scour protection installation to up to 16 vessels for OSS installation. For export cable installation, it is currently estimated that up to six vessels could be operating at once. Across the Projects, if all construction activities were occurring concurrently (which is unlikely), a total of 51 vessels could be present at any one time.



Table 4.10-1 Representative Offshore Construction Vessels

Role	Vessel Type	Count	Approx. Length	Approx. Width	Approx. Operational Speed (knots)
<b>Foundation Installation</b>					
Foundation Installation	Bulk Carrier	1	722-755 ft (220-230 m)	66-82 ft (20-25 m)	10
	Medium heavy Lift Vessel	1	591-722 ft (180-220 m)	131-164 ft (40-50 m)	10
	Jack-Up Vessel	1	591-607 ft (180 – 185 m)	197 ft (60 m)	10
Bubble Curtain Support Vessel	Tugboat	1	230-246 ft (70 – 75 m)	49-66 ft (15 – 20 m)	10
Transport Barge	Barge	2-3	394-410 ft (120 – 125 m)	98-115 ft (30 – 35 m)	3-10
Towing Tugboat	Tugboat	2-6	98-115 ft (30 – 35 m)	33-49 ft (10 – 15 m)	3-10
Support Vessel	Service Operation Vessel	1	295-344 ft (90 – 105 m)	49-66 ft (15 – 20 m)	10
Crew Transfer and Noise Monitoring	CTV	1	82-98 ft (25 – 30 m)	30-33 ft (9 – 10 m)	29

Table 4.10-1 Representative Offshore Construction Vessels (Continued)

Role	Vessel Type	Count	Approx. Length	Approx. Width	Approx. Operational Speed (knots)
<b>OSS Installation</b>					
OSS Installation	Large Heavy Lift Vessel	1	640-656 ft (195 – 200 m)	279-295 ft (85 – 90 m)	10
	Medium Heavy Lift Vessel	1	591-722 ft (180 – 220 m)	131-164 ft (40-50 m)	10
Bubble Curtain Support Vessel	Tugboat	1	230-246 ft (70 – 75 m)	49-66 ft (15 – 20 m)	10
Transport Barge	Barge	4	394-410 ft (120 – 125 m)	98-115 ft (30 – 35 m)	10
Towing Tugboat	Tugboat	4	98-115 ft (30 – 35 m)	33-49 ft (10 – 15 m)	10
Assistance Tugboat	Tugboat	2	230-246 ft (70 – 75 m)	49-66 ft (15 – 20 m)	10
Crew Transfer and Noise Monitoring	CTV	1	82-98 ft (25 – 30 m)	30-33 ft (9 – 10 m)	29
<b>Scour Protection</b>					
Scour Protection Installation	Fall Pipe Vessel	1	623-640 ft (190 – 195 m)	131-148 ft (40 – 45 m)	10
Dredging	Dredger	1	640-656 ft (195 – 200 m)	131-148 ft (40 – 45 m)	10

Table 4.10-1 Representative Offshore Construction Vessels (Continued)

Role	Vessel Type	Count	Approx. Length	Approx. Width	Approx. Operational Speed (knots)
<b>WTG Installation</b>					
WTG Installation	Jack-Up Vessel	1	591-607 ft (180 – 185 m)	197 ft (60 m)	10
Towing Tugboat	Towing Tugboat	2	98-115 ft (30 – 35 m)	33-49 ft (10 – 15 m)	10
Feeder Vessel	Jack-Up Feeder	2	407-410 ft (124-125 m)	128-131 ft (39-40 m)	10
	Barge	2-3	394-410 ft (120 – 125 m)	98-115 ft (30 – 35 m)	10
	Harbor Tugboat	1	98-115 ft (30 – 35 m)	33-49 ft (10 – 15 m)	10
WTG Commissioning and Crew Transfer	Service Operation Vessel	1	295-344 ft (90 – 105 m)	49-66 ft (15 – 20 m)	10
	CTV	1	82-98 ft (25 – 30 m)	30-33 ft (9 – 10 m)	29
<b>Inter-Array Cable Installation</b>					
Cable Installation	Cable Installation Vessel	1	246-541 ft (75 – 165 m)	82-115 ft (25 – 35 m)	10
Support Vessel	Service Operation Vessel	1	295-344 ft (90 – 105 m)	49-66 ft (15 – 20 m)	10

Table 4.10-1 Representative Offshore Construction Vessels (Continued)

Role	Vessel Type	Count	Approx. Length	Approx. Width	Approx. Operational Speed (knots)
<b>Inter-Array Cable Installation</b>					
Cable Burial Vessel	Cable Installation Vessel	1	246-541 ft (75 – 165 m)	82-115 ft (25 – 35 m)	10
Dredging	Dredger	1	640-656 ft (195 – 200 m)	131-148 ft (40 – 45 m)	10
Anchor Handling Tug Supply (AHTS) Vessel	AHTS	2	246-262 ft (75 – 80 m)	49-66 ft (15 – 20 m)	10
Rock Dumping Vessel	Fall Pipe Vessel	1	623-640 ft (190 – 195 m)	131-148 ft (40 – 45 m)	10
<b>Export Cable Installation</b>					
Cable Installation	Cable Installation Vessel	1	246-541 ft (75 – 165 m)	82-115 ft (25 – 35 m)	10
Support & Jointing Vessel	Support Vessel	1	312-328 ft (95 – 100 m)	66 ft (20 m)	10
Dredging	Dredger	1	640-656 ft (195 – 200 m)	131-148 ft (40 – 45 m)	10
AHTS Vessel	AHTS	1	246-262 ft (75 – 80 m)	49-66 ft (15 – 20 m)	10
Rock Dumping Vessel	Fall Pipe Vessel	1	640-656 ft (195 – 200 m)	131-148 ft (40 – 45 m)	10

Table 4.10-1 Representative Offshore Construction Vessels (Continued)

Role	Vessel Type	Count	Approx. Length	Approx. Width	Approx. Operational Speed (knots)
<b>Fuel Bunkering</b>					
Towing Tugboat	Towing Tugboat	1	98-115 ft (30 – 35 m)	33-49 ft (10 – 15 m)	10
Transport Barge	Barge	1	394-410 ft (120 – 125 m)	98-115 ft (30 – 35 m)	10

## 4.10.2 Onshore Construction

Onshore construction can be broken into two key activities: construction of the onshore substation and installation of the onshore interconnection cables/duct bank. Onshore construction will be performed using standard construction equipment typical for onshore infrastructure projects such as the installation of new transmission lines.

Onshore substation construction will resemble typical construction at a power plant or mainland substation. Onshore construction equipment can be expected to include excavators, concrete trucks, forklifts, trenchers, loaders, and backhoes. Typical grading equipment will be used for any clearing and grading needed at the onshore substation site. Onshore substation equipment is expected to be delivered by large trucks and may include oversized-load deliveries. Installation of substation equipment could also require the use of cranes and other support vehicles.

Installation of the onshore interconnection cables and concrete duct bank will require the use of typical construction equipment such as dump trucks, front-end loaders, concrete trucks, and excavators. Cable installation will also require construction vehicles that are more specifically designed for cable management such as winches and cable reel trucks.

## 4.10.3 Construction Port Facilities and Staging Areas

Atlantic Shores has identified several port facilities in New Jersey, New York, the Mid-Atlantic, and New England that may be used for major construction staging activities for the Projects. In addition, some components, materials, and vessels could come from U.S. Gulf Coast or international ports.

Construction ports will be utilized for the following functions:

- crew transfers;
- component fabrication and assembly;
- receiving and offloading shipments of Project components;
- storing Project components;
- preparing Project components for installation;
- loading Project components onto installation vessels or other suitable vessels for delivery to the Offshore Project Area for installation; and/or
- preparing vessels to tow floating components to the WTA.

A list of U.S. ports considered for temporary use during major construction staging activities is provided in Table 4.10-2 and depicted on Figure 4.10-1; it is likely that only some of the ports identified will be utilized for the Projects' construction.

Table 4.10-2 Ports that May be Used During Construction of the Projects

Port	Location	Description	Staging/Pre-Assembly Activities that May Occur			
			WTG	OSS	Foundation	Offshore Cables
<b>New Jersey Ports</b>						
New Jersey Wind Port	Lower Alloways Creek, New Jersey	New Jersey plans to develop the New Jersey Wind Port as a marshaling and manufacturing site for offshore wind projects. Phase 1 of port construction is targeted to start in 2021, and New Jersey anticipates the port will become available in 2023 with a 30-acre (0.12-km <sup>2</sup> ) marshaling area, 25-acre (0.10-km <sup>2</sup> ) manufacturing site, and heavy-lift wharf. Phase 2 of port construction is targeted to start in 2023. As part of Phase 2, more than 160 acres (0.65 km <sup>2</sup> ) of additional marshaling and manufacturing space with additional berths and room for Tier 2 suppliers is expected to become available in 2024-2026 (State of New Jersey 2020).	<ul style="list-style-type: none"> <li>•</li> </ul> Includes full tower assembly	<ul style="list-style-type: none"> <li>•</li> </ul>	<ul style="list-style-type: none"> <li>•</li> </ul> For piled, suction bucket, and gravity foundations	<ul style="list-style-type: none"> <li>•</li> </ul>
Port of Paulsboro	Paulsboro, New Jersey	The Paulsboro Marine Terminal comprises 200 acres (0.81 km <sup>2</sup> ) on the Delaware River. Its available berth is approximately 850 ft (260 m) in length, with a water depth of approximately 40 ft (12 m) at Mean Low Water (MLW). The port is currently being developed for staging and manufacturing monopiles. The existing 850-foot-long (260-m-long) quayside is currently fully utilized, but an additional 1,500-ft (457-m) quayside is under construction and will have a bearing capacity of 1,500 pounds per square foot (psf) (73 ton/m <sup>2</sup> ). Construction is expected to be completed in 2021 (South Jersey Port Corporation 2020).	<ul style="list-style-type: none"> <li>•</li> </ul>	<ul style="list-style-type: none"> <li>•</li> </ul> For smaller OSS types	<ul style="list-style-type: none"> <li>•</li> </ul> For piled and gravity foundations	<ul style="list-style-type: none"> <li>•</li> </ul>

Table 4.10-2 Ports that May be Used During Construction of the Projects (Continued)

Port	Location	Description	Staging/Pre-Assembly Activities that May Occur			
			WTG	OSS	Foundation	Offshore Cables
<b>New Jersey Ports</b>						
Port Newark Container Terminal (PNCT)	Elizabeth, New Jersey	PNCT occupies 272 acres (1.1km <sup>2</sup> ) in the Port Authority of New York and New Jersey (PANYNJ) and currently handles containerized cargo. PNCT has secured a long-term lease agreement with the PANYNJ through 2050. The port has a navigable depth of approximately 50 ft (15 m) in Newark Bay. The port has invested in increasing its container volume capacity and crane handling capacity (PNCT 2020).	•	• For smaller OSS types	• For piled and gravity foundations	•
Repauno Port & Rail Terminal	Greenwich Township, New Jersey	Repauno Port & Rail Terminal (Repauno) is a 1,600-acre (6.47-km <sup>2</sup> ) site along the Delaware River in Greenwich Township, New Jersey. Formerly the site of a DuPont manufacturing facility, the site is currently being redeveloped into a multi-use port facility for energy products, roll-on/roll-off, project cargo, bulk cargo, warehousing, and logistics. The port features a new multi-purpose dock with an approximately 40-ft (12-m) draft capable of handling a wide variety of products.	•	• For smaller OSS types	• For piled and gravity foundations	•
Military Ocean Terminal at Bayonne (MOTBY)	Bayonne, New Jersey	The MOTBY is located on a 427-acre (1.73-km <sup>2</sup> ), approximately two-mile-long (3.22-km-long) manmade peninsula that extends into upper New York Harbor. Dredged fill materials were used to create the peninsula in 1939. The MOTBY is currently an active port and shipyard with portions of the site being redeveloped for residential and commercial use and warehousing.	•	• For smaller OSS types	• For piled and gravity foundations	•



Table 4.10-2 Ports that May be Used During Construction of the Projects (Continued)

Port	Location	Description	Staging/Pre-Assembly Activities that May Occur			
			WTG	OSS	Foundation	Offshore Cables
<b>New York Ports</b>						
Port of Albany	Albany, New York	The 343-acre (1.39-km <sup>2</sup> ) Port of Albany features deep-water facilities and wharfs on both sides of the Hudson River, including 4,200 ft (1,280 m) of wharf on the Albany side of the river and 1,200 ft (366 m) on the Rensselaer side of the river. The undeveloped portion of the Port of Albany at Beacon Island may be used to support offshore wind development activities. The developed portion of the Port is used for bulk and break bulk, heavy lift/project cargo, offshore wind development activities, and other various functions (Port of Albany 2019).	•		• For piled and gravity foundations	•
Port of Coeymans Marine Terminal	Coeymans, New York	The 400-acre (1.6-km <sup>2</sup> ) Port of Coeymans Marine Terminal is a privately-owned port located on the Hudson River approximately 10 mi (16 km) south of Albany and 100 mi (160 km) north of New York City. The inlet channel associated with the terminal has approximately 3,260 ft (994 m) of water frontage (COWI North America 2017; Port of Coeymans 2020). The Port serves a variety of projects such as bridge assembly and construction and is the resource and disaster recovery hub of the Northeast.	•		• For piled and gravity foundations	•

Table 4.10-2 Ports that May be Used During Construction of the Projects (Continued)

Port	Location	Description	Staging/Pre-Assembly Activities that May Occur			
			WTG	OSS	Foundation	Offshore Cables
<b>New York Ports</b>						
Red Hook Container Terminal	Brooklyn, New York	Red Hook Container Terminal in Brooklyn, New York encompasses approximately 148 acres (0.60 km <sup>2</sup> ), with approximately 70 acres (0.28 km <sup>2</sup> ) currently available for development activities. The site currently operates as a bulk and container terminal and shares its south end with a cruise terminal. The terminal includes approximately 1,900 ft (580 m) of water frontage and minimum wharf lengths of approximately 700 ft (212 m) and 600 ft (183 m) at berth (COWI North America 2017).	•	• For smaller OSS types	• For piled and gravity foundations	•
Brooklyn Navy Yard	Brooklyn, New York	The Brooklyn Navy Yard is an industrial park that encompasses 300 acres (1.21 km <sup>2</sup> ) of land along the waterfront in Brooklyn, New York that includes manufacturers, producers, offices, and amenities and is also under development. Approximately 20 acres (0.08 km <sup>2</sup> ) within the industrial park may be used to support offshore wind development (BNYDC 2020).			• For piled and gravity foundations	•
South Brooklyn Marine Terminal (SBMT)	Brooklyn, New York	The SBMT encompasses approximately 88 acres (0.76 km <sup>2</sup> ) of land with approximately 9,400 ft (2,860 m) of waterfront frontage in the PANYNJ. The SBMT has undergone an extensive renovation and currently offers a myriad of services including tug and barge, dry bulk and break bulk stevedoring, maritime freight transload	•	• For smaller OSS types	• For piled and gravity foundations	•

Table 4.10-2 Ports that May be Used During Construction of the Projects (Continued)

Port	Location	Description	Staging/Pre-Assembly Activities that May Occur			
			WTG	OSS	Foundation	Offshore Cables
<b>New York Ports</b>						
South Brooklyn Marine Terminal (SBMT) (Continued)	Brooklyn, New York	to and from truck and rail, lay-berthing and dockside repair of industrial and commercial vessels, and other industrial maritime dependent uses. The port is proposed to be upgraded to support staging, installation, and maintenance of offshore wind farms (Kassel 2020).				
Port Ivory	Staten Island, New York	Port Ivory is approximately 64 acres (0.26 km <sup>2</sup> ) of land owned by the PANYNJ located along the Arthur Kill Channel in the northwestern corner of Staten Island, New York. The site can be accessed by the New York Container Terminal rail line, I-278 highway, or by barge along the Arthur Kill Channel. The waterfront is currently undeveloped (COWI North America 2019).	•	• For smaller OSS types	• For piled and gravity foundations	•
Howland Hook Marine Terminal (GCT New York)	Staten Island, New York	Howland Hook Marine Terminal, owned by New York City and leased to PANYNJ/Global Container Terminals (GCT), is a full-service container and cargo terminal comprising 187 acres (0.76 km <sup>2</sup> ) on the west side of Staten Island, New York (GCT c2020). The terminal has approximately 3,200 ft (972 m) of water frontage and a minimum wharf length of approximately 2,500 ft (767 m) (COWI North America 2017).	•	• For smaller OSS types	• For piled and gravity foundations	•

Table 4.10-2 Ports that May be Used During Construction of the Projects (Continued)

Port	Location	Description	Staging/Pre-Assembly Activities that May Occur			
			WTG	OSS	Foundation	Offshore Cables
<b>New York Ports</b>						
Arthur Kill Terminal	Staten Island, New York	The Arthur Kill Terminal is a proposed 32-acre (0.13-km <sup>2</sup> ) port facility in Staten Island, New York that will be developed for offshore wind facility staging and assembly. The terminal will feature strong bearing capacity for WTGs, on-site warehouse storage for equipment, and an approximately 1,300-ft (396-m) quayside designed for simultaneous vessel berthing (Atlantic Offshore Terminals c2020). The facility may be operational by 2023.	•  Includes full tower assembly	•	•  For piled, suction bucket, and gravity foundations	•
<b>Delaware Ports</b>						
Port of Wilmington	Wilmington, Delaware	The 308-acre (1.25-km <sup>2</sup> ) Port of Wilmington is a full-service deep-water port and marine terminal located at the confluence of the Delaware and Christina Rivers. The port operates as an auto and container port. The port has identified 60 acres (0.26 km <sup>2</sup> ) for offshore wind use and includes approximately 3,500 ft (1,067 m) of deep-water berths (GT USA 2020).	•	•  For smaller OSS types	•  For piled and gravity foundations	•

Table 4.10-2 Ports that May be Used During Construction of the Projects (Continued)

Port	Location	Description	Staging/Pre-Assembly Activities that May Occur			
			WTG	OSS	Foundation	Offshore Cables
<b>Maryland Ports</b>						
Tradepoint Atlantic Terminal	Sparrow's Point, Maryland	Tradepoint Atlantic terminal (formerly Sparrow's Point Terminal) occupies 3,300 acres (13.35 km <sup>2</sup> ) and operates as a logistics and maritime development port. Deep-water frontage includes channel depths ranging from approximately 36 to 42 ft (11 to 13 m), with plans to deepen channel depths to approximately 40 to 50 ft (12 to 15 m). The terminal has two active vessel berths, including a 2,200-ft (670-m) berth, and a 1,150-ft (350-m) finger pier (Tradepoint Atlantic 2020).	•	• For smaller OSS types	• For piled and gravity foundations	•
<b>Virginia Ports</b>						
Portsmouth Marine Terminal	Portsmouth, Virginia	Portsmouth Marine Terminal occupies 287 acres (1.2 km <sup>2</sup> ) on the west bank of the Elizabeth River in Portsmouth, Virginia. The terminal is operated by CSX Intermodal Terminals, Inc. and serves both domestic and international freight. It currently handles containers, breakbulk, and roll-on/roll-off cargo. The facilities include approximately 3,540 ft (1,079 m) of wharf and three berths (Virginia Port Authority 2020).	• Includes full tower assembly	•	• For piled, suction bucket, and gravity foundations	•

Table 4.10-2 Ports that May be Used During Construction of the Projects (Continued)

Port	Location	Description	Staging/Pre-Assembly Activities that May Occur			
			WTG	OSS	Foundation	Offshore Cables
<b>Massachusetts Ports</b>						
New Bedford Marine Commerce Terminal	New Bedford, Massachusetts	The 30-acre (0.12-km <sup>2</sup> ) New Bedford Marine Commerce Terminal was purpose-built for offshore wind staging and marshaling. The port is owned and operated by the Massachusetts Clean Energy Center and is located in a highly protected industrial harbor on the northwest side of Buzzards Bay. The port has full load-bearing capacity for large crawler cranes and a modern heavy-lift quayside built specifically for offshore wind load-out and load-in and marshaling. A moderate-sized warehouse building onsite can be used (Port of New Bedford 2018).	<ul style="list-style-type: none"> <li>•</li> </ul> <p>Includes full tower assembly</p>		<ul style="list-style-type: none"> <li>•</li> </ul> <p>For piled Foundations</p>	<ul style="list-style-type: none"> <li>•</li> </ul>
Brayton Point	Somerset, Massachusetts	The Brayton Point Commerce center is located on the site of the former coal-fired Brayton Point Power Plant in Somerset, Massachusetts on the Commonwealth's south coast. It is the largest available waterfront property in southeastern Massachusetts with an approximately 700-ft (213-m) quayside and a water depth of 34 ft (10 m). In December 2018, Brayton Point was purchased by Commercial Development Company, Inc. via affiliate Brayton Point LLC. The 300-acre (1.2-km <sup>2</sup> ) site is being converted to a logistical port and support center for offshore wind operations. The port will be capable of component manufacturing, staging operations, and maintenance for offshore wind and other related sectors (Brayton Point 2019).			<ul style="list-style-type: none"> <li>•</li> </ul> <p>For piled and gravity foundations</p>	<ul style="list-style-type: none"> <li>•</li> </ul>

Table 4.10-2 Ports that May be Used During Construction of the Projects (Continued)

Port	Location	Description	Staging/Pre-Assembly Activities that May Occur			
			WTG	OSS	Foundation	Offshore Cables
<b>Rhode Island Ports</b>						
Port of Davisville	North Kingstown, Rhode Island	The Port of Davisville is located in a sheltered harbor in North Kingstown, Rhode Island. It offers five terminals, approximately 4,500 ft (1,372 m) of berthing space at two 1,200-ft-long (366-m-long) piers, a bulkhead, on-dock rail, and 58 acres (0.23 km <sup>2</sup> ) of laydown and terminal storage. It currently operates as a major auto port and frozen seafood port. In addition, a crew transfer vessel engineered to service offshore wind projects is based at Quonset.	•		• For piled and gravity foundations	•
<b>Connecticut Ports</b>						
Port of Bridgeport	Bridgeport, Connecticut	The Port of Bridgeport was acquired by Seaview Bridgeport LLC from Bridgeport Port Authority in 2017. Bridgeport Port Authority plans to restore the site as a shipyard. The port is located in proximity to Interstate 95 and Connecticut Routes 8 & 25 (Connecticut Port Authority 2019).	• Including full tower assembly	•	• For piled, suction bucket, and gravity foundations	•
<b>Specialty Ports</b>						
Brewer	Brewer, Maine	This 42-acre (0.17-km <sup>2</sup> ) site in Brewer, Maine has a module yard facility that has been used for fabrication of various oil and gas infrastructure.	•	• For smaller OSS types	• For piled and gravity Foundations	•

Table 4.10-2 Ports that May be Used During Construction of the Projects (Continued)

Port	Location	Description	Staging/Pre-Assembly Activities that May Occur			
			WTG	OSS	Foundation	Offshore Cables
<b>Specialty Ports</b>						
Ingleside	Ingleside, Texas	Jackets, topsides, onshore and offshore modules, living quarters, subsea kits, piles, and tendons are fabricated at this 500-acre (2-km <sup>2</sup> ) manufacturing site. The site also houses the world's largest offshore lifter that is 550 ft (167 m) tall and can lift 13,000 tons.		•	• For piled, suction bucket, and gravity foundations	
Houma	Houma, Louisiana	Located on the Houma Navigation Canal 30 mi (48 km) from the Gulf of Mexico, the site has 12,720 ft (3,877 m) of water frontage and 283 acres (1.15 km <sup>2</sup> ) of undeveloped land that is available for expansion. The site fabricates complex steel structures, modules, and marine vessels for the oil and gas industries.		•	• For piled, suction bucket, and gravity foundations	
Columbus Street Terminal	Charleston, South Carolina	Columbus Street Terminal is owned by the South Carolina Ports Authority and primarily handles roll-on/roll-off, breakbulk, and project cargo. It has 3,500 ft (762 m) of berth and a depth of 45 ft (14 m) with unlimited air draft.	• Including full tower assembly	•	• For piled, suction bucket, and gravity foundations	•



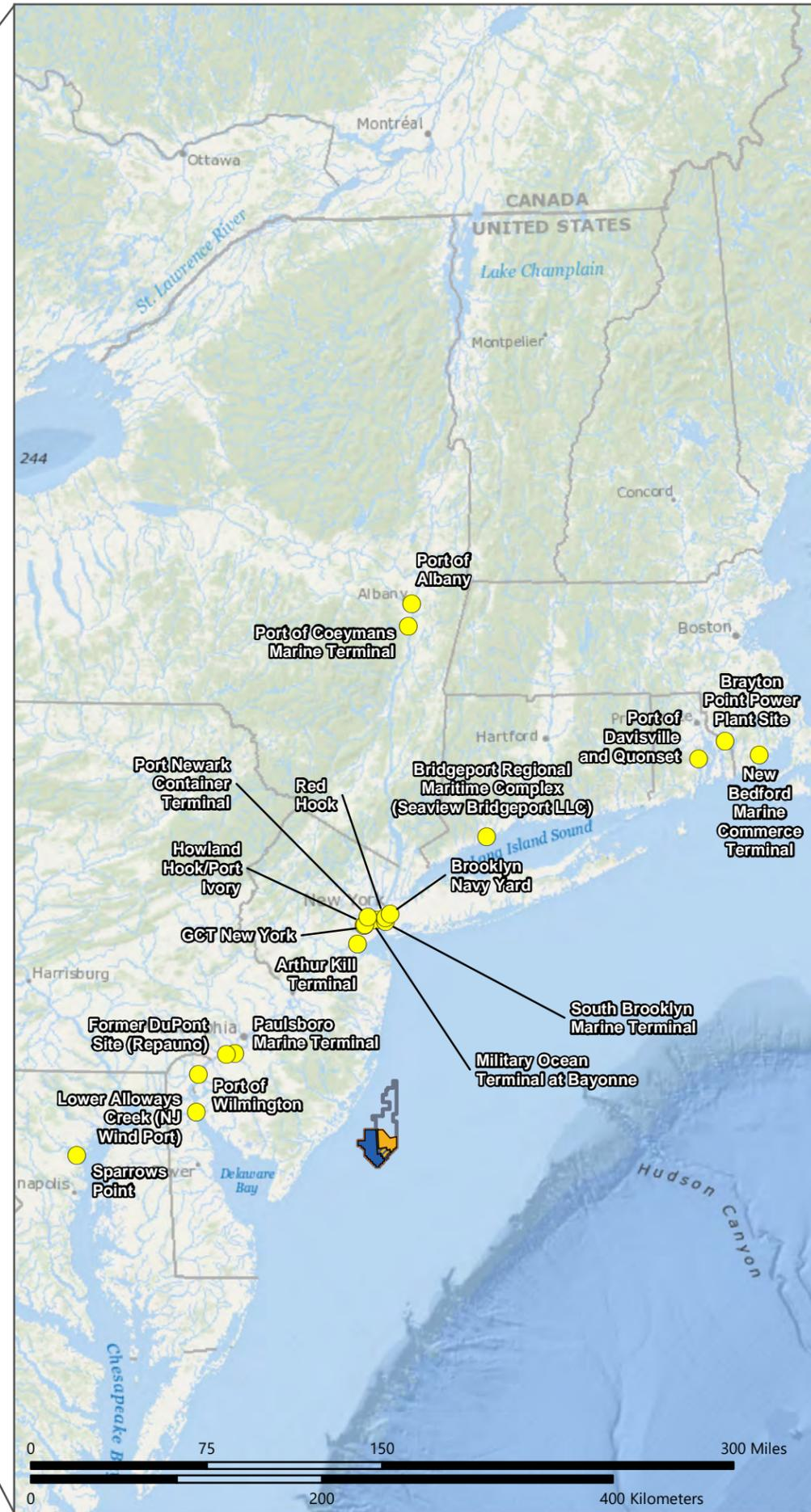
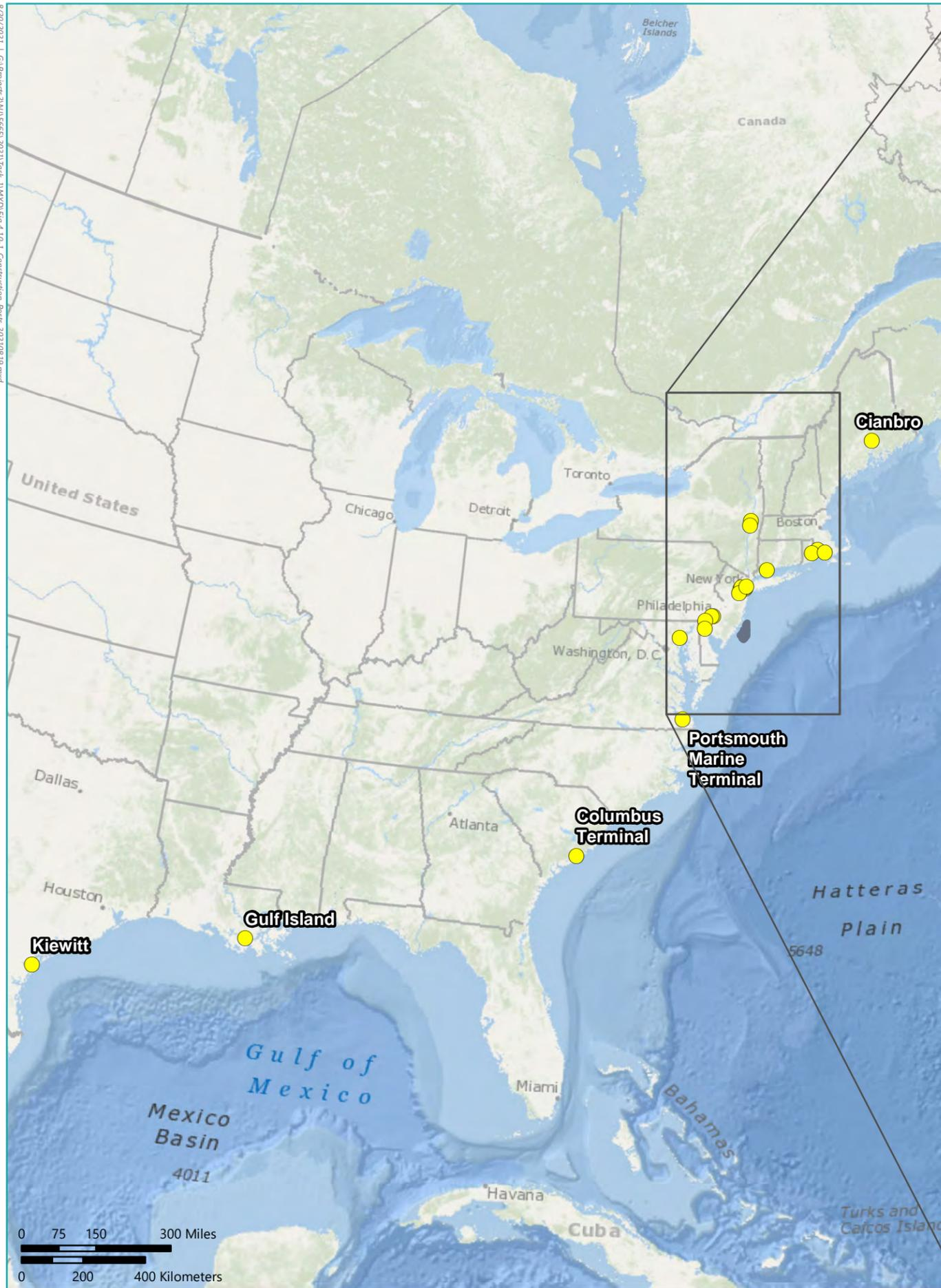

Map Projection: NAD 1983 UTM Zone 18N (Meters)  
 Basemap: World Ocean Base, Esri

**LEGEND**

- Potential Construction Port
- Lease Area OCS-A 0499
- Atlantic Shores Wind Turbine Area
- Project 1 Area
- Project 2 Area
- Overlap Area (Project 1 or 2)

**Figure 4.10-1**

Potential Construction Ports in the U.S.

Other industrial ports not identified in Table 4.10-2 may be utilized for limited, basic activities associated with marine construction in general rather than offshore wind specifically. These activities may include, but are not limited to, refueling (although some refueling is expected to occur offshore), restocking supplies, and sourcing parts for repairs.

All port facilities being considered to support the Projects' construction are located within industrial waterfront areas with existing marine industrial infrastructure or where such infrastructure is proposed for development within the required Projects' timeframe. Some port requirements specifically pertaining to offshore wind construction projects include:

- high load-bearing ground and deck capacity, especially quayside;
- adequate vessel berthing parameters, including depth of berths to accommodate large installation vessels; and
- suitable laydown and fabrication space, which may require grading and resurfacing.

Atlantic Shores will not implement any port improvements but may contribute financial support to a port's redevelopment as part of a multi-developer economic incentive package. Any port development will occur independent of the Projects, including any permitting or approvals that the port facility owner/lessor may need to obtain. If structures, vessels, and/or cranes more than 200 ft (61 m) high are required to accommodate construction, necessary approvals from the Federal Aviation Administration (FAA) will be obtained.

Identifying a wide range of construction ports is important because many port entities have plans to upgrade or further develop port facilities in support of the burgeoning offshore wind industry. It is essential for the Projects to have the ability to utilize the most appropriate port facilities for construction given uncertainties regarding which planned port upgrades will be completed within the Projects' development schedule and projected demand for the port facilities by other offshore wind developers. It is likely that only some of the ports identified in Table 4.10-2 will be utilized for the Projects' construction; the ports ultimately selected for use will depend on the status of port upgrades and final construction logistics planning.

#### 4.11 Summary of Maximum Design Scenario and Seafloor Disturbance

This section describes how the PDE described in Sections 4.1 through 4.9 was used to define the maximum design scenario for the resource assessments in Volume II. Potential effects to resources were evaluated using the maximum potential build-out of the Projects:

- The maximum onshore build-out of **the Projects** is defined as construction at two landfall sites (Monmouth and Atlantic Landfall Sites), installation of onshore interconnection cables within two onshore interconnection cable routes (the Larrabee and Cardiff Onshore Interconnection Cable Routes), and construction of two new onshore substations (one each for the Larrabee and Cardiff POIs).

- The maximum onshore build-out of **Project 1** is defined as construction at either or both landfall sites (Monmouth or Atlantic Landfall Site), installation of onshore interconnection cables within either or both onshore interconnection cable routes (the Larrabee or Cardiff Onshore Interconnection Cable Routes), and construction of either or both new onshore substations (either the Larrabee or Cardiff POI).
- The maximum onshore build-out of **Project 2** is defined as construction at either or both landfall sites (Monmouth or Atlantic Landfall Site), installation of onshore interconnection cables within either or both onshore interconnection cable routes (the Larrabee or Cardiff Onshore Interconnection Cable Routes), and construction of either or both new onshore substations (either the Larrabee or Cardiff POI).
- The maximum offshore build-out of **the Projects** is defined as installation of up to 200 WTGs, 10 small OSSs,<sup>21</sup> one permanent met tower, four temporary metocean buoys, eight offshore export cables (with a maximum total length of 441 mi [710 km]), 547 mi (880 km) of inter-array cables, and 37 mi (60 km) of inter-link cables, along with associated scour and cable protection.
  - The maximum offshore build-out of **Project 1** is installation of up to 136 WTGs (assumes Project 1 uses all available positions in the Overlap Area), 5 small OSSs, one permanent met tower, three temporary metocean buoys, four offshore export cables (with a maximum total length of 341.8 mi [550.0 km]), 273.5 mi (440 km) of inter-array cables, and 18.6 mi (30 km) of inter-link cables, along with associated scour and cable protection.
  - The maximum offshore build-out of **Project 2** is installation of up to 95 WTGs (assumes Project 2 uses all available positions in the Overlap Area), 5 small OSSs, one temporary metocean buoy, four offshore export cables (with a maximum total length of 341.8 mi [550.0 km]), 273.5 mi (440 km) of inter-array cables, and 18.6 mi (30 km) of inter-link cables, along with associated scour and cable protection.

In addition to using the maximum onshore or offshore build-out of the Projects, each specific resource section in Volume II further describes if there are any additional aspects of the PDE used to define the maximum design scenario for that resource (such as if all 200 WTGs are assumed to use a particular foundation type).

The maximum area of total permanent and temporary seabed disturbance in the WTA and ECCs from construction of the Projects is provided in Table 4.11-1. The maximum area of total permanent and temporary seabed disturbance for Project 1 and 2 individually is provided in Tables 4.11-2 and 4.11-3, respectively. The “Basis of Calculation” column describes which option included within the PDE was used to calculate the maximum potential seabed disturbance.

---

<sup>21</sup> Alternatively, for some resources, the maximum design scenario considers four large OSSs.

Table 4.11-1 Maximum Total Seabed Disturbance for the Projects

Installation Activity	Maximum Area of Seafloor Disturbance			Basis of Calculation
	Permanent Disturbance	Additional Temporary Disturbance	Total <sup>a</sup>	
WTG Foundation Installation (Including Scour Protection)	0.80 mi <sup>2</sup> (2.08 km <sup>2</sup> )	0.55 mi <sup>2</sup> (1.43 km <sup>2</sup> )	1.14 mi <sup>2</sup> (2.96 km <sup>2</sup> )	<ul style="list-style-type: none"> <li>• <b>For permanent disturbance:</b> 200 suction bucket jacket foundations with a total permanent footprint (foundation + scour protection) of 111,987.6 ft<sup>2</sup> (10,404.0 m<sup>2</sup>) each.</li> <li>• <b>For additional temporary disturbance:</b> 200 mono-bucket foundations with an additional seabed disturbance of 76,835.7 ft<sup>2</sup> (7,138.3 m<sup>2</sup>) each.</li> <li>• <b>For total disturbance:</b> 200 suction bucket jacket foundations with a total seabed disturbance of 159,348.8 ft<sup>2</sup> (14,804.0 m<sup>2</sup>) each.</li> </ul> <p>See Table 4.2-1 in Section 4.2.</p>
WTG Installation and Commissioning	N/A (Included in WTG foundation footprint)	0.11 mi <sup>2</sup> (0.29 km <sup>2</sup> )	0.11 mi <sup>2</sup> (0.29 km <sup>2</sup> )	200 WTGs installed with 10,763.9 ft <sup>2</sup> (1000.0 m <sup>2</sup> ) of disturbance from one jack-up WTG installation vessel and 4,869.5 ft <sup>2</sup> (452.4 m <sup>2</sup> ) of disturbance from one jack-up feeder vessel at each WTG position. See Table 4.3-2 in Section 4.3.
OSS Foundation Installation (Including Scour Protection), Topside Installation, and Commissioning	0.04 mi <sup>2</sup> (0.11 km <sup>2</sup> )	0.05 mi <sup>2</sup> (0.13 km <sup>2</sup> )	0.08 mi <sup>2</sup> (0.20 km <sup>2</sup> )	<ul style="list-style-type: none"> <li>• <b>For permanent disturbance:</b> Four large OSSs using suction bucket jacket foundations, with a total permanent footprint (foundation + scour protection) of 282,961.4 ft<sup>2</sup> (26,288.0 m<sup>2</sup>) each.</li> <li>• <b>For additional temporary disturbance:</b> Ten small OSSs using mono-bucket foundations, each with an additional seabed disturbance of 76,835.7 ft<sup>2</sup> (7,138.3 m<sup>2</sup>) for foundation installation and 58,125.1 ft<sup>2</sup> (5,400.0 m<sup>2</sup>) for topside installation and commissioning.</li> <li>• <b>For total disturbance:</b> Ten small OSSs using suction bucket jacket foundations, each with a total seabed disturbance of 159,348.8 ft<sup>2</sup> (14,804.0 m<sup>2</sup>) for foundation installation and 58,125.1 ft<sup>2</sup> (5,400.0 m<sup>2</sup>) for topside installation and commissioning.</li> </ul> <p>See Table 4.2-1 in Section 4.2 and Tables 4.4-1, 4.4-2, and 4.4-4 in Section 4.4.</p>

Table 4.11-1 Maximum Total Seabed Disturbance for the Projects (Continued)

Installation Activity	Maximum Area of Seafloor Disturbance			Basis of Calculation
	Permanent Disturbance	Additional Temporary Disturbance	Total <sup>a</sup>	
Export Cable Installation (Including HDD and Cable Protection)				
Atlantic Landfall Site to OSS	0.10 mi <sup>2</sup> (0.26 km <sup>2</sup> )	1.10 mi <sup>2</sup> (2.85 km <sup>2</sup> )	1.20 mi <sup>2</sup> (3.11 km <sup>2</sup> )	Installation of four HVAC export cables with a total length of 99.4 mi (160.0 km) for all four cables, along with six 2,153-ft <sup>2</sup> (200-m <sup>2</sup> ) HDD pits and four 2,583 ft <sup>2</sup> (240-m <sup>2</sup> ) cofferdams at the landfall site. See Table 4.5-1 in Section 4.5 and Section 4.7.1.
Monmouth Landfall Site to OSS	0.36 mi <sup>2</sup> (0.93 km <sup>2</sup> )	2.52 mi <sup>2</sup> (6.51 km <sup>2</sup> )	2.87 mi <sup>2</sup> (7.44 km <sup>2</sup> )	Installation of four HVAC export cables with a total length of 341.8 mi (550.0 km) for all four cables, along with six 2,153-ft <sup>2</sup> (200-m <sup>2</sup> ) HDD pits and four 2,583 ft <sup>2</sup> (240-m <sup>2</sup> ) cofferdams at the landfall site. See Table 4.5-1 in Section 4.5 and Section 4.7.1.
Inter-Array Cable Installation (Including Cable Protection)	0.44 mi <sup>2</sup> (1.14 km <sup>2</sup> )	2.92 mi <sup>2</sup> (7.57 km <sup>2</sup> )	3.36 mi <sup>2</sup> (8.71 km <sup>2</sup> )	Installation of 546.8 mi (880.0 km) of inter-array cables. See Table 4.5-2 in Section 4.5.
Inter-Link Cable Installation (Including Cable Protection)	0.03 mi <sup>2</sup> (0.08 km <sup>2</sup> )	0.25 mi <sup>2</sup> (0.65 km <sup>2</sup> )	0.28 mi <sup>2</sup> (0.74 km <sup>2</sup> )	Installation of 37.3 mi (60.0 km) of inter-link cables. See Table 4.5-2 in Section 4.5.
Met Tower Installation (Including Scour Protection)	N/A	N/A	N/A	There is sufficient conservatism in the total estimates of permanent and temporary seafloor disturbance from WTG foundation installation to account for the impacts from the met tower's installation. See Section 4.6.1.
Metocean Buoy Installation	N/A	0.02 mi <sup>2</sup> (0.05 km <sup>2</sup> )	0.02 mi <sup>2</sup> (0.05 km <sup>2</sup> )	Installation of four temporary metocean buoys with a total temporary seafloor disturbance of 0.005 mi <sup>2</sup> (0.013 km <sup>2</sup> ) each. See Section 4.6.2.

Table 4.11-1 Maximum Total Seabed Disturbance for the Projects (Continued)

Installation Activity	Maximum Area of Seafloor Disturbance			Basis of Calculation
	Permanent Disturbance	Additional Temporary Disturbance	Total <sup>a</sup>	
<b>Max. Total Seabed Disturbance in the WTA</b>	1.40 mi <sup>2</sup> (3.62 km <sup>2</sup> )	4.43 mi <sup>2</sup> (11.48 km <sup>2</sup> )	5.79 mi <sup>2</sup> (15.0 km <sup>2</sup> )	Combined seabed disturbance from WTG foundation installation, WTG installation and commissioning, OSS installation and commissioning, met tower installation, metocean buoy installation, inter-array and inter-link cable installation, and installation of the portion of the export cables within the WTA (see Table 4.5-1 in Section 4.5).
<b>Max. Total Seabed Disturbance in the ECCs</b>	0.38 mi <sup>2</sup> (0.98 km <sup>2</sup> )	3.09 mi <sup>2</sup> (8.00 km <sup>2</sup> )	3.29 mi <sup>2</sup> (8.52 km <sup>2</sup> )	Combined seabed disturbance from the installation of four export cables within the Atlantic ECC and four export cables in the Monmouth ECC from the landfall sites to the boundary of the WTA (see Table 4.5-1 in Section 4.5).

Note:

- a) For WTG, OSS, and met tower foundations, the foundation type with the maximum footprint is not the same as the type with the maximum area of additional seabed disturbance. Thus, the sum of the maximum area of permanent disturbance and additional temporary disturbance does not equal the total seabed disturbance.

Table 4.11-2 Maximum Total Seabed Disturbance for Project 1

Installation Activity	Maximum Area of Seafloor Disturbance			Basis of Calculation
	Permanent Disturbance	Additional Temporary Disturbance	Total <sup>a</sup>	
WTG Foundation Installation (Including Scour Protection)	0.55 mi <sup>2</sup> (1.41 km <sup>2</sup> )	0.37 mi <sup>2</sup> (0.97 km <sup>2</sup> )	0.78 mi <sup>2</sup> (2.01 km <sup>2</sup> )	<ul style="list-style-type: none"> <li>• <b>For permanent disturbance:</b> 136 suction bucket jacket foundations with a total permanent footprint (foundation + scour protection) of 111,987.6 ft<sup>2</sup> (10,404.0 m<sup>2</sup>) each.</li> <li>• <b>For additional temporary disturbance:</b> 136 mono-bucket foundations with an additional seabed disturbance of 76,835.7 ft<sup>2</sup> (7,138.3 m<sup>2</sup>) each.</li> <li>• <b>For total disturbance:</b> 136 suction bucket jacket foundations with a total seabed disturbance of 159,348.8 ft<sup>2</sup> (14,804.0 m<sup>2</sup>) each.</li> </ul> <p>See Table 4.2-1 in Section 4.2.</p>
WTG Installation and Commissioning	N/A (Included in WTG foundation footprint)	0.08 mi <sup>2</sup> (0.20 km <sup>2</sup> )	0.08 mi <sup>2</sup> (0.20 km <sup>2</sup> )	136 WTGs installed with 10,763.9 ft <sup>2</sup> (1000.0 m <sup>2</sup> ) of disturbance from one jack-up WTG installation vessel and 4,869.5 ft <sup>2</sup> (452.4 m <sup>2</sup> ) of disturbance from one jack-up feeder vessel at each WTG position. See Table 4.3-2 in Section 4.3.
OSS Foundation Installation (Including Scour Protection), Topside Installation, and Commissioning	0.02 mi <sup>2</sup> (0.05 km <sup>2</sup> )	0.02 mi <sup>2</sup> (0.06 km <sup>2</sup> )	0.04 mi <sup>2</sup> (0.10 km <sup>2</sup> )	<ul style="list-style-type: none"> <li>• <b>For permanent disturbance:</b> Two large OSSs using suction bucket jacket foundations, with a total permanent footprint (foundation + scour protection) of 282,961.4 ft<sup>2</sup> (26,288.0 m<sup>2</sup>) each.</li> <li>• <b>For additional temporary disturbance:</b> Five small OSSs using mono-bucket foundations, each with an additional seabed disturbance of 76,835.7 ft<sup>2</sup> (7,138.3 m<sup>2</sup>) for foundation installation and 58,125.1 ft<sup>2</sup> (5,400.0 m<sup>2</sup>) for topside installation and commissioning.</li> <li>• <b>For total disturbance:</b> Five small OSSs using suction bucket jacket foundations, each with a total seabed disturbance of 159,348.8 ft<sup>2</sup> (14,804.0 m<sup>2</sup>) for foundation installation and 58,125.1 ft<sup>2</sup> (5,400.0 m<sup>2</sup>) for topside installation and commissioning.</li> </ul> <p>See Table 4.2-1 in Section 4.2 and Tables 4.4-1, 4.4-2, and 4.4-4 in Section 4.4.</p>

Table 4.11-2 Maximum Total Seabed Disturbance for Project 1 (Continued)

Installation Activity	Maximum Area of Seafloor Disturbance			Basis of Calculation
	Permanent Disturbance	Additional Temporary Disturbance	Total <sup>a</sup>	
Export Cable Installation (Including HDD and Cable Protection)				Project 1 will use the Atlantic ECC <b>or</b> the Monmouth ECC, so seafloor disturbances are presented for both.
Atlantic Landfall Site to OSS  <b>or</b>	0.10 mi <sup>2</sup> (0.26 km <sup>2</sup> )	1.10 mi <sup>2</sup> (2.85 km <sup>2</sup> )	1.20 mi <sup>2</sup> (3.11 km <sup>2</sup> )	Installation of four HVAC export cables with a total length of 99.4 mi (160.0 km) for all four cables, along with six 2,153-ft <sup>2</sup> (200-m <sup>2</sup> ) HDD pits and four 2,583 ft <sup>2</sup> (240-m <sup>2</sup> ) cofferdams at the landfall site. See Table 4.5-1 in Section 4.5 and Section 4.7.1.
Monmouth Landfall Site to OSS	0.36 mi <sup>2</sup> (0.93 km <sup>2</sup> )	2.52 mi <sup>2</sup> (6.51 km <sup>2</sup> )	2.87 mi <sup>2</sup> (7.44 km <sup>2</sup> )	Installation of four HVAC export cables with a total length of 341.8 mi (550.0 km) for all four cables, along with six 2,153-ft <sup>2</sup> (200-m <sup>2</sup> ) HDD pits and four 2,583 ft <sup>2</sup> (240-m <sup>2</sup> ) cofferdams at the landfall site. See Table 4.5-1 in Section 4.5 and Section 4.7.1.
Inter-Array Cable Installation (Including Cable Protection)	0.22 mi <sup>2</sup> (0.57 km <sup>2</sup> )	1.46 mi <sup>2</sup> (3.78 km <sup>2</sup> )	1.68 mi <sup>2</sup> (4.35 km <sup>2</sup> )	Installation of 273.4 mi (440.0 km) of inter-array cables. See Table 4.5-2 in Section 4.5.
Inter-Link Cable Installation (Including Cable Protection)	0.02 mi <sup>2</sup> (0.04 km <sup>2</sup> )	0.13 mi <sup>2</sup> (0.33 km <sup>2</sup> )	0.14 mi <sup>2</sup> (0.37 km <sup>2</sup> )	Installation of 18.6 mi (30.0 km) of inter-link cables. See Table 4.5-2 in Section 4.5.
Met Tower Installation (Including Scour Protection)	N/A	N/A	N/A	There is sufficient conservatism in the total estimates of permanent and temporary seafloor disturbance from WTG foundation installation to account for the impacts from the met tower's installation. See Section 4.6.1.
Metocean Buoy Installation	N/A	0.02 mi <sup>2</sup> (0.04 km <sup>2</sup> )	0.02 mi <sup>2</sup> (0.04 km <sup>2</sup> )	Installation of three temporary metocean buoys with a total temporary seafloor disturbance of 0.005 mi <sup>2</sup> (0.013 km <sup>2</sup> ) each. See Section 4.6.2.



Table 4.11-2 Maximum Total Seabed Disturbance for Project 1 (Continued)

Installation Activity	Maximum Area of Seafloor Disturbance			Basis of Calculation
	Permanent Disturbance	Additional Temporary Disturbance	Total <sup>a</sup>	
<b>Max. Total Seabed Disturbance in the WTA</b>	0.84 mi <sup>2</sup> (2.18 km <sup>2</sup> )	2.33 mi <sup>2</sup> (6.03 km <sup>2</sup> )	3.04 mi <sup>2</sup> (7.87 km <sup>2</sup> )	Combined seabed disturbance from WTG foundation installation, WTG installation and commissioning, OSS installation and commissioning, met tower installation, metocean buoy installation, inter-array and inter-link cable installation, and installation of the portion of the export cables within the WTA (see Table 4.5-1 in Section 4.5).
<b>Max. Total Seabed Disturbance in the ECCs</b>	0.32 mi <sup>2</sup> (0.83 km <sup>2</sup> )	2.26 mi <sup>2</sup> (5.86 km <sup>2</sup> )	2.57 mi <sup>2</sup> (6.65 km <sup>2</sup> )	While Project 1 could use either the Atlantic or Monmouth ECC, assumes seabed disturbance from the installation of four export cables within the Monmouth ECC from the landfall sites to the boundary of the WTA (see Table 4.5-1 in Section 4.5).

Note:

- a) For WTG, OSS, and met tower foundations, the foundation type with the maximum footprint is not the same as the type with the maximum area of additional seabed disturbance. Thus, the sum of the maximum area of permanent disturbance and additional temporary disturbance does not equal the total seabed disturbance.

Table 4.11-3 Maximum Total Seabed Disturbance for Project 2

Installation Activity	Maximum Area of Seafloor Disturbance			Basis of Calculation
	Permanent Disturbance	Additional Temporary Disturbance	Total <sup>a</sup>	
WTG Foundation Installation (Including Scour Protection)	0.38 mi <sup>2</sup> (0.99 km <sup>2</sup> )	0.26 mi <sup>2</sup> (0.68 km <sup>2</sup> )	0.54 mi <sup>2</sup> (1.41 km <sup>2</sup> )	<ul style="list-style-type: none"> <li>• <b>For permanent disturbance:</b> 95 suction bucket jacket foundations with a total permanent footprint (foundation + scour protection) of 111,987.6 ft<sup>2</sup> (10,404.0 m<sup>2</sup>) each.</li> <li>• <b>For additional temporary disturbance:</b> 95 mono-bucket foundations with an additional seabed disturbance of 76,835.7 ft<sup>2</sup> (7,138.3 m<sup>2</sup>) each.</li> <li>• <b>For total disturbance:</b> 95 suction bucket jacket foundations with a total seabed disturbance of 159,348.8 ft<sup>2</sup> (14,804.0 m<sup>2</sup>) each.</li> </ul> <p>See Table 4.2-1 in Section 4.2.</p>
WTG Installation and Commissioning	N/A (Included in WTG foundation footprint)	0.05 mi <sup>2</sup> (0.14 km <sup>2</sup> )	0.05 mi <sup>2</sup> (0.14 km <sup>2</sup> )	95 WTGs installed with 10,763.9 ft <sup>2</sup> (1000.0 m <sup>2</sup> ) of disturbance from one jack-up WTG installation vessel and 4,869.5 ft <sup>2</sup> (452.4 m <sup>2</sup> ) of disturbance from one jack-up feeder vessel at each WTG position. See Table 4.3-2 in Section 4.3.
OSS Foundation Installation (Including Scour Protection), Topside Installation, and Commissioning	0.02 mi <sup>2</sup> (0.05 km <sup>2</sup> )	0.02 mi <sup>2</sup> (0.06 km <sup>2</sup> )	0.04 mi <sup>2</sup> (0.10 km <sup>2</sup> )	<ul style="list-style-type: none"> <li>• <b>For permanent disturbance:</b> Two large OSSs using suction bucket jacket foundations, with a total permanent footprint (foundation + scour protection) of 282,961.4 ft<sup>2</sup> (26,288.0 m<sup>2</sup>) each.</li> <li>• <b>For additional temporary disturbance:</b> Five small OSSs using mono-bucket foundations, each with an additional seabed disturbance of 76,835.7 ft<sup>2</sup> (7,138.3 m<sup>2</sup>) for foundation installation and 58,125.1 ft<sup>2</sup> (5,400.0 m<sup>2</sup>) for topside installation and commissioning.</li> <li>• <b>For total disturbance:</b> Five small OSSs using suction bucket jacket foundations, each with a total seabed disturbance of 159,348.8 ft<sup>2</sup> (14,804.0 m<sup>2</sup>) for foundation installation and 58,125.1 ft<sup>2</sup> (5,400.0 m<sup>2</sup>) for topside installation and commissioning.</li> </ul> <p>See Table 4.2-1 in Section 4.2 and Tables 4.4-1, 4.4-2, and 4.4-4 in Section 4.4.</p>

Table 4.11-3 Maximum Total Seabed Disturbance for Project 2 (Continued)

Installation Activity	Maximum Area of Seafloor Disturbance			Basis of Calculation
	Permanent Disturbance	Additional Temporary Disturbance	Total <sup>a</sup>	
Export Cable Installation (Including HDD and Cable Protection)				Project 2 will use the Atlantic ECC <b>or</b> the Monmouth ECC, so seafloor disturbances are presented for both.
Atlantic Landfall Site to OSS  <b>or</b>	0.10 mi <sup>2</sup> (0.26 km <sup>2</sup> )	1.10 mi <sup>2</sup> (2.85 km <sup>2</sup> )	1.20 mi <sup>2</sup> (3.11 km <sup>2</sup> )	Installation of four HVAC export cables with a total length of 99.4 mi (160.0 km) for all four cables, along with six 2,153-ft <sup>2</sup> (200-m <sup>2</sup> ) HDD pits and four 2,583 ft <sup>2</sup> (240-m <sup>2</sup> ) cofferdams at the landfall site. See Table 4.5-1 in Section 4.5 and Section 4.7.1.
Monmouth Landfall Site to OSS	0.36 mi <sup>2</sup> (0.93 km <sup>2</sup> )	2.52 mi <sup>2</sup> (6.51 km <sup>2</sup> )	2.87 mi <sup>2</sup> (7.44 km <sup>2</sup> )	Installation of four HVAC export cables with a total length of 341.8 mi (550.0 km) for all four cables, along with six 2,153-ft <sup>2</sup> (200-m <sup>2</sup> ) HDD pits and four 2,583 ft <sup>2</sup> (240-m <sup>2</sup> ) cofferdams at the landfall site. See Table 4.5-1 in Section 4.5 and Section 4.7.1.
Inter-Array Cable Installation (Including Cable Protection)	0.22 mi <sup>2</sup> (0.57 km <sup>2</sup> )	1.46 mi <sup>2</sup> (3.78 km <sup>2</sup> )	1.68 mi <sup>2</sup> (4.35 km <sup>2</sup> )	Installation of 273.4 mi (440.0 km) of inter-array cables. See Table 4.5-2 in Section 4.5.
Inter-Link Cable Installation (Including Cable Protection)	0.02 mi <sup>2</sup> (0.04 km <sup>2</sup> )	0.13 mi <sup>2</sup> (0.33 km <sup>2</sup> )	0.14 mi <sup>2</sup> (0.37 km <sup>2</sup> )	Installation of 18.6 mi (30.0 km) of inter-link cables. See Table 4.5-2 in Section 4.5.
Metocean Buoy Installation	N/A	0.005 mi <sup>2</sup> (0.013 km <sup>2</sup> )	0.005 mi <sup>2</sup> (0.0013 km <sup>2</sup> )	Installation of one temporary metocean buoys with a total temporary seafloor disturbance of 0.005 mi <sup>2</sup> (0.013 km <sup>2</sup> ) each. See Section 4.6.2.

Table 4.11-3 Maximum Total Seabed Disturbance for Project 2 (Continued)

Installation Activity	Maximum Area of Seafloor Disturbance			Basis of Calculation
	Permanent Disturbance	Additional Temporary Disturbance	Total <sup>a</sup>	
<b>Max. Total Seabed Disturbance in the WTA</b>	0.68 mi <sup>2</sup> (1.75 km <sup>2</sup> )	2.18 mi <sup>2</sup> (5.66 km <sup>2</sup> )	2.77 mi <sup>2</sup> (7.17 km <sup>2</sup> )	Combined seabed disturbance from WTG foundation installation, WTG installation and commissioning, OSS installation and commissioning, metocean buoy installation, inter-array and inter-link cable installation, and installation of the portion of the export cables within the WTA (see Table 4.5-1 in Section 4.5).
<b>Max. Total Seabed Disturbance in the ECCs</b>	0.32 mi <sup>2</sup> (0.83 km <sup>2</sup> )	2.26 mi <sup>2</sup> (5.86 km <sup>2</sup> )	2.57 mi <sup>2</sup> (6.65 km <sup>2</sup> )	While Project 2 could use either the Atlantic or Monmouth ECC, assumes seabed disturbance from the installation of four export cables within the Monmouth ECC from the landfall sites to the boundary of the WTA (see Table 4.5-1 in Section 4.5).

Note:

- b) For WTG and OSS foundations, the foundation type with the maximum footprint is not the same as the type with the maximum area of additional seabed disturbance. Thus, the sum of the maximum area of permanent disturbance and additional temporary disturbance does not equal the total seabed disturbance.

## 5.0 Operations and Maintenance

Once commissioned, the Projects are designed to operate for up to 30 years.<sup>22</sup> Operations and maintenance (O&M) activities will ensure the Projects function safely and efficiently. To minimize equipment downtime and maximize energy generation, the Projects will conduct O&M activities through scheduled, predictive, and remotely-controlled activities. O&M activities will be performed by experienced, well-trained personnel.

The health and safety of people and the environment are at the forefront of planning and execution for all O&M activities (see Section 1.5.3). The Atlantic Shores Project Companies will reinforce this priority by ensuring that personnel comply with all applicable health, safety, security, and environmental (HSSE) laws and regulations and by developing and refining O&M procedures through an iterative process that incorporates knowledge gained throughout the Projects' operations and from other offshore wind projects.

The Projects' O&M strategy builds upon the following guiding principles:

- health and safety;
- environmental protection;
- compliance with regulations;
- maximum availability and energy output of wind farm;
- efficiency of resources and personnel to minimize costs; and
- continuous improvement of operational processes.

The Projects incorporate these guiding principles into all aspects of its operational planning and execution. In addition, Atlantic Shores requires its subcontractors to follow these guiding principles.

### 5.1 Monitoring and Control Systems

Monitoring systems are vital tools for recording and maintaining data, performing quality assurance, and monitoring asset performance.

All Projects' facilities, including the wind turbine generators (WTGs) and offshore substations (OSSs), are designed to operate autonomously without on-site attendance by technicians. The Projects will be equipped with a supervisory control and data acquisition (SCADA) system to interface between the WTG controllers, OSSs, onshore substations, and all environmental and condition monitoring sensors and to provide detailed performance and system information.

---

<sup>22</sup> Atlantic Shores' Lease Agreement OCS-A 0499 includes a 25 year operating term, which may be extended or otherwise modified in accordance with applicable regulations in 30 CFR Part 585.

Monitored parameters may include temperature, vibration, status, current, and voltage amongst others. The SCADA system is configured to provide notifications of any alarms or warnings from Project components.

The SCADA system is remotely accessible to the Projects' operator through a remote control center. The SCADA system also provides remote control of the Projects' equipment, allowing the operator to override automatic operations, remotely reset the Projects' systems, adjust control parameters, and shut down equipment for maintenance or at the request of grid operators, regulators, or search and rescue (SAR) (e.g., shut down of WTGs upon the U.S. Coast Guard's [USCG's] request). The operator will monitor the status, production, and health of the Projects 24 hours per day. Performance and fault statistics will be stored and analyzed for long-term trends as well as changes in performance of individual components.

Data from the SCADA system will be primarily transmitted through the fiber optics that are included in the offshore cables, but the SCADA system will incorporate redundancies, such as multiple network connections (e.g., a combination of radio, satellite, and/or wireless network technology) to ensure constant control of Projects' assets.

The condition monitoring systems of various subsystems are centralized into the SCADA system so that this data can be used to identify underperformance issues and major equipment failures before they occur. Proactive utilization of real-time data and monitoring techniques will reduce downtime, repair costs, production losses, and enable root cause analyses to limit similar failures across the Projects. Examples of condition monitoring systems include structural strain monitoring, cable distributed temperature system (DTS), and WTG bearing vibration.

The export cables are expected to include a DTS to constantly monitor the cables' temperature at points along their length to help identify anomalous conditions (i.e., potential changes in cable burial depth) that may require maintenance and/or corrective action. The inter-array cables and inter-link cables (if used) may also use DTS. Other monitoring systems, such as a distributed acoustic sensing (DAS) system and/or online partial discharge (OLPD) monitoring, can also be used to constantly assess the status of the offshore cables. A DAS system employs the fiber optics within the cables to detect noises that could result from anomalous conditions such as insufficient cable depth, vibrations, and potential damage. An OLPD monitoring system can identify the presence and location of insulation damage that can eventually lead to cable failures.

## 5.2 Communication Systems

In addition to the SCADA system, the Projects will likely utilize a number of additional communication systems to manage overall operations. Examples of such systems include, but are not limited to:

- weather monitoring and forecasting to maximize efficient working hours, safe transfers, and appropriate weather windows;

- vessel tracking and sea surveillance to avoid and minimize potential interactions with marine mammals, fishing vessels, and recreational boaters;
- radio and cellular networks for voice and data communications offshore and onshore; and
- personnel/people tracking for efficient and safe planning.

Offshore communication is typically supported by existing infrastructure, such as wireless network technology or typical marine and aviation communications channels that can be assisted by mounting marine very high frequency (VHF) radio antennas and wireless antennas on the OSSs. Data transfer from offshore Project components is enabled through wireless communication (e.g., Wi-Fi, WiMax protocols, or wireless network technology) and can be supported by fiber optic cables that are bundled with the offshore cables.

As with control systems, offshore wind communications systems will incorporate redundancies, such as multiple network connections.

### 5.3 Lighting and Marking

The WTGs, OSSs, meteorological (met) tower, and their associated foundations will be equipped with marine navigation lighting and marking in accordance with USCG and the Bureau of Ocean Energy Management (BOEM) guidance. To aid mariners navigating within and near the Wind Turbine Area (WTA), each WTG, OSS, and met tower position will be maintained as a Private Aid to Navigation (PATON). Based on USCG District 5 Local Notice to Mariner 45/20, Atlantic Shores expects to include unique alphanumeric identification on each WTG and/or foundation, yellow flashing lights on each foundation that are visible in all directions, and Mariner Radio Activated Sound Signals (MRASS) on select foundations. It is anticipated that the marine navigation lights on structures along the perimeter of the WTA will be visible at a range of 3 or 5 nautical miles (nm) (depending on the structure's location), whereas lights on interior structures will be visible at a range of 2 nm. Automatic Identification System (AIS) will be used to mark each WTG, OSS, and met tower position (virtually or using physical transponders). Atlantic Shores will work with the USCG and BOEM to determine the appropriate marine lighting and marking schemes for the proposed offshore facilities, including the number, location, and type of AIS transponders. Additional information on marine navigation lighting and marking can be found in the Navigation Safety Risk Assessment (NSRA) (see Appendix II-S).

All WTGs and the met tower will contain aviation obstruction lights in accordance with Federal Aviation Administration (FAA) and/or BOEM guidance to aid aircraft operating in the WTA. Based on current guidance in FAA Advisory Circular 70/7460-1M, the aviation obstruction lighting system on the WTGs will include red flashing lights on the nacelle and, if the WTG exceeds 699 feet (ft) (213.36 meters [m]), an additional level of flashing red lights on the tower. The lights will be arranged so that they are visible by a pilot approaching from any direction. In accordance with Advisory Circular 70/7460-1M, the color of the WTGs will be no lighter than RAL 9010 (Pure White) and no darker than RAL 7035 (Light Grey). If the height of the OSSs exceeds 200 ft (61 m) above Mean Sea Level (MSL) or any obstruction standard contained in 14 CFR Part 77, the OSSs will

include an aviation obstruction lighting system in compliance with FAA and/or BOEM requirements. Atlantic Shores is considering use of an Aircraft Detection Lighting System (ADLS), subject to FAA and BOEM approval, which could substantially reduce the amount of time that the aviation obstruction lights are actually illuminated. An ADLS automatically activates all aviation obstruction lights when aircraft approach the WTA; at all other times, the lights are off.

Other temporary lighting (e.g., helicopter hoist status lights) may be utilized on the WTGs for safety purposes when necessary. Similarly, some outdoor OSS lighting (in addition to any required aviation or marine navigation lighting) will be necessary for maintenance that may occur at night. Atlantic Shores anticipates using controls to ensure that outdoor OSS lighting will be illuminated only when the OSS is manned. When unmanned, general outdoor lighting will be off.

## 5.4 Operations, Maintenance, and Inspections

A comprehensive O&M Plan for the Projects will be developed, which will include plans for scheduled and un-scheduled inspections and maintenance activities to keep the Projects operating with optimum reliability and performance throughout the design life. A risk-based maintenance approach will be used to balance long-term operating costs with the Projects' performance.

Scheduled maintenance is performed on a fixed, predetermined schedule (e.g., annually) and may consist of remote monitoring, inspections, testing, replacement of consumables, and preventive maintenance. As part of the scheduled maintenance, self-inspections will be conducted in accordance with 30 CFR §§ 585.824 and 585.825. Scheduled maintenance of offshore facilities will be performed during non-winter months when accessibility is highest. The frequency of inspections, tests, and maintenance will be based on industry standards and best practices.

Unscheduled maintenance is performed in response to a sensor alarm or fault indicating a component malfunction or to an event that causes accidental damage. Unscheduled maintenance may involve inspections, troubleshooting, and corrective maintenance, and may occur at any time of the year. Atlantic Shores will conduct a post-event inspection after an event that causes damage to a structure (e.g., a ship allision) or after a storm during which measured environmental conditions exceeded specified conditions (e.g., a hurricane or significant storm event).

All maintenance activities will follow the procedures outlined in each Project's Safety Management System (SMS) (see Section 1.5.3.1). Maintenance activities will only be performed after appropriate preparatory actions have been taken according to the O&M Plan, including risk assessment and method statement development, marine traffic coordination, and checking that communication and remote monitoring and control systems are functional. Atlantic Shores will document and record all maintenance activities according to the O&M Plan.

The Atlantic Shores Project Companies will provide access to and accommodate BOEM or its qualified third-party inspectors for the purposes of conducting inspections or reviewing maintenance records according to 30 CFR §§ 585.820-585.823.



## 5.4.1 WTGs

### Scheduled Maintenance

Scheduled maintenance of WTGs includes regularly scheduled inspections and routine maintenance of mechanical and electrical components. Most scheduled maintenance and associated crew transfer will be performed using crew transfer vessels (CTVs), service operation vessels (SOVs), and/or helicopters (see Section 5.6). The types and frequency of inspections and maintenance activities are based on detailed original equipment manufacturer (OEM) specifications. Annual maintenance campaigns are dedicated to general upkeep (e.g., bolt tensioning, crack and coating inspection, safety equipment inspection, cleaning, high-voltage component service, and blade inspection) and replacement of consumable components (e.g., lubrication, oil changes).

Preventative maintenance (e.g., planned replacement of components such as motors and brakes) occurs less frequently (every 5 to 10 years) but is also regularly scheduled.

### Unscheduled Maintenance

Unscheduled inspections and minor repairs, such as replacement of small components, can be performed via the regular maintenance vessels. Replacement of large components (e.g., blades, generators, gearboxes, and large bearings) or structural repair may require support vessels, such as jack-up vessels with cranes, as well as larger teams of technicians.

## 5.4.2 OSS Topsides

### Scheduled Maintenance

OSSs undergo annual maintenance to both medium-voltage and high-voltage systems, auxiliary systems, and safety systems as well as topside structural inspections. Portions of the topsides may require the reapplication of corrosion-resistant coating. Diesel generators located on the OSSs will also require routine maintenance and refueling.

### Unscheduled Maintenance

Corrective maintenance for OSS topside infrastructure includes minor structural repairs discovered during inspections, electrical repairs discovered either during inspections or through operational faults, and relatively rare movable part overhauls. Replacement of major components (e.g., transformers) is expected to occur infrequently and will likely require support vessels similar to those required for WTG major component replacement activities.

### 5.4.3 Foundations and Scour Protection

#### Scheduled Maintenance

WTG, OSS, and met tower foundations will be inspected both above and underwater at regular intervals to check their condition including checking for corrosion, cracking, and marine growth (see Table 5.4-1). Scheduled maintenance of foundations will also include safety inspections and testing, coating touch up, preventative maintenance of cranes, electrical equipment, and auxiliary equipment, and removal of marine growth.

#### Unscheduled Maintenance

Unscheduled maintenance will be conducted for minor component repair/replacement if damage to a foundation occurs (e.g., due to an accidental event or conditions that exceed the foundation's design loads). Corrective actions will be taken if any issues with scour protection are discovered.

### 5.4.4 Offshore Cables

#### Scheduled Maintenance

As described in Section 5.1, the offshore cables may be continuously monitored using DTS, a DAS system, and/or OLPD monitoring. In addition, cable surveys will be performed at regular intervals to identify any issues associated with potential scour and depth of burial. Annual surveys will be performed for the first few years of operation, and provided no abnormal conditions are detected during those initial surveys, less frequent surveys will continue for the life of the Projects. Cable terminations and hang-offs will be inspected and maintained during scheduled maintenance of foundations, OSS, or WTGs.

#### Unscheduled Maintenance

In the unlikely event that a cable becomes exposed, the issue will be addressed by reburying the cable and/or applying cable protection. Vessels supporting these procedures will typically be of the same type as those used during construction (see Section 4.10.1). Atlantic Shores will store spare cable at an O&M facility, a dedicated warehouse, or with the cable supplier to expedite the repair process in the unlikely event that the Projects experience a cable failure.

### 5.4.5 Onshore Substations and Onshore Interconnection Cables

#### Scheduled Maintenance

Electrical systems at the onshore substations such as transformers, switchgear, harmonic filters, reactive power equipment, revenue meters, protection and control systems, and auxiliary services will be regularly monitored. Scheduled maintenance of the onshore interconnection cables will also be performed; any necessary maintenance will be accessed through manholes and completed within the installed transmission infrastructure.

## Unscheduled Maintenance

Unscheduled inspections and minor repairs, such as troubleshooting, testing, and replacement of small components, can be performed *in situ*. Manlifts and small cranes may be used to work on elevated equipment. For larger pieces of equipment (e.g., transformers, reactors, major static synchronous compensator (STATCOM) components, breakers, or structure equipment) that require in-shop service or replacement, heavy duty construction equipment, such as cranes similar in size to those used during construction, may be used to aid in removal and replacement. Although unlikely, if a section of onshore interconnection cable fails, cable pulling equipment would be needed.

### 5.4.6 Representative Inspection and Maintenance Schedule

A representative schedule of the Projects' inspection and maintenance activities is presented in Table 5.4-1. This schedule provides an overview of the estimated frequency of inspection and maintenance activities; it is expected that this schedule will be updated during the detailed design process.

Table 5.4-1 Schedule of Planned Preventive Maintenance Activities

Project Component	Activity	Frequency
WTG	Inspections	Annual
	Maintenance of mechanical, electrical, structural, and safety systems	Annual
	Retrofits/upgrade	As needed
	Gearbox oil change	2-3 times over lifespan, as needed
	Major preventative maintenance	5, 7, or 10-year intervals
OSS	Inspections	Annual
	Maintenance of medium-voltage and high-voltage systems, auxiliary systems, and safety systems	Annual
	Diesel generator refueling	As needed
Foundation	Above water inspection	Annual
	Below water inspection	20% of positions per year (may be modified based on site and design risk assessment)
	Maintenance of structural, auxiliary, and safety systems	Annual

Table 5.4-1 Schedule of Planned Preventive Maintenance Activities (Continued)

Project Component	Activity	Frequency
Offshore Cables (Export, Inter-Array, and Inter-Link)	Survey	Annually during the first few years of operations and at less frequent intervals thereafter (may be modified based on site and design risk assessment)
	Electrical tests	Every 5 years
Onshore Substation	Inspection	Annual
	Maintenance of medium-voltage and high-voltage systems, auxiliary systems, and safety systems	Annual
Onshore Interconnection Cables	Visual and thermographic inspections of cables and terminations inside vaults	Annual
	Electrical tests	Every 5 years

## 5.5 O&M Facility and Ports

Once operational, the Project will be supported by a new O&M facility that Atlantic Shores is proposing to establish in Atlantic City, New Jersey (see Figure 1.1-2). The O&M facility will be used solely by Atlantic Shores as the primary location for O&M operations including material storage, day-to-day management of inspection and maintenance activities, vehicle parking, marine coordination, vessel docking, and dispatching of technicians. The O&M facility will be designed to provide a safe and efficient operational flow of activities and equipment, and will consist of the following:

- office space, including a server/IT room to house the Project’s critical IT infrastructure, and a control room for surveillance and coordination of offshore activities and Project operations;
- warehouse space, including full-height access for deliveries and equipment storage, a temperature and humidity-controlled electrical storage room, and a lifting facility;
- harbor area and quayside, including but not limited to vessel mooring, unloading capabilities, a crane, berthing area, and emergency spill response equipment; and
- outdoor area and parking, including storage space for spare parts and materials.

To establish the O&M facility, Atlantic Shores intends to purchase and develop a shoreside parcel in Atlantic City that was formerly used for vessel docking or other port activities. Construction of the O&M facility is expected to involve the construction of a new building and associated parking

lot, repairs to any existing bulkheads/docks, installation of new dock facilities, and limited marine dredging. The potential effects from construction of the O&M facility will be provided in the 2021 COP supplement. The O&M facility developed at the shoreside parcel in Atlantic City may also be supported with the use of existing warehouse or office space within an industrial, commercial, and/or waterfront area.

Atlantic Shores will likely establish a long-term CTV base at the O&M facility in Atlantic City. If Atlantic Shores employs an SOV-based O&M strategy, those SOVs would likely be operated out of existing ports such as Lower Alloways Creek Township, the Port of New Jersey/New York, or another industrial port identified in Table 4.10-2 that has suitable water depths to support an SOV.

Atlantic Shores may use other ports listed in Table 4.10-2 to support O&M activities such as some crew transfer, bunkering,<sup>23</sup> spare part storage, and load-out of spares to vessels. In addition, routine port activities such as refueling and supply replenishment may occur outside of the ports identified in Table 4.10-2. While it is anticipated that the ports listed in Table 4.10-2 can support the Project's needs, it is possible that if significant non-routine maintenance is needed for the Project, it could require unplanned use of another U.S. or international port.

Lastly, the O&M facility and vessels used for the Projects may also be integrated with those of other Atlantic Shores projects, depending on the timing of those developments. A shared operational strategy will realize efficiencies and is expected to reduce environmental impacts during O&M by reducing overall vessel usage within Lease Area OCS-A 0499.

## 5.6 Proposed Vessels, Vehicles, and Aircraft

A combination of CTVs, SOVs, other smaller vessels, and helicopters may be used to access infrastructure in the WTA. The vessels are likely to be dispatched from the quayside at the O&M facility or other supporting O&M ports. The logistical approach will aim to share facilities and vessels, where possible, to maximize efficiency and minimize the environmental impact of transporting personnel, materials, and tools. In addition to CTVs, SOVs, and smaller vessels, the Projects may also use jack-up, heavy-lift, or other larger support vessels on an infrequent basis for large component replacement. If the characteristics of the O&M facility's port are unsuitable for the types of vessels required to complete the repair or for the quayside logistics required to manage larger components, a nearby port will be used (see Section 5.5). In addition, Atlantic Shores may use fixed-wing aircraft to support environmental monitoring and mitigation.

---

<sup>23</sup> Some refueling could also occur offshore. All options described in this paragraph would be conducted in accordance with applicable Jones Act requirements and other applicable law.

Atlantic Shores may utilize a CTV-based logistical approach due to the proximity of the WTA to the O&M facility in Atlantic City and the O&M facility's port characteristics (e.g., water depths). CTVs enable faster, more practical transport of personnel and equipment to the Projects' offshore facilities than SOVs when the transit distance is relatively short (see Figure 5.6-1 for a representative photo of a CTV). CTVs may transit daily between the CTV base and WTA. Helicopters can be used when rapid-response O&M activities are needed or when poor weather limits the use of CTVs. Helicopters would be based within reasonable distance of the Projects at a general aviation airport.

SOVs are relatively large vessels that offer considerable capacity for personnel and spare parts, allowing for service trips that are several weeks in duration (see Figure 5.6-1). SOVs include sleeping quarters for technicians and may include workshop space. SOVs are capable of transferring technicians to WTGs and OSSs through use of gangways. Typically, an SOV is equipped with a dynamic positioning (DP) system, lifting and winch capacity, and may support a helipad. SOVs are only limited by the need to return to port to restock fuel, food, and spare parts but are typically used in conjunction with smaller daughter crafts/workboats or CTVs to enable quick transport of personnel or supplies between the vessel and port or offshore assets. An SOV-based O&M strategy may also rely upon helicopters to shuttle technicians and equipment within the WTA.

In addition to CTVs, SOVs, and helicopters, other vessels and vehicles may be used to support O&M activities over the lifetime of the Projects:

- Although CTVs and SOVs are the most common vessels around which O&M logistical approaches are designed, an alternative approach employs a service accommodation and transfer vessel (SATV), which is larger than a CTV and supports week-long service campaigns.
- Larger support vessels (e.g., jack-up vessels) may be used infrequently to perform some routine maintenance activities, periodic corrective maintenance, and significant repairs (if needed). These vessels are similar to vessels used during construction.
- Survey vessels may be required for subsea inspection campaigns.
- Cable laying vessels may support cable repair campaigns.
- Other monitoring and inspection needs may be met by unmanned aerial vehicles, remotely-operated vehicles (ROVs), or underwater drones.



**Example Crew Transfer Vessel (CTV)**



**Example Service Operation Vessel (SOV)**

- Various land-based vehicles, including trucks and heavy equipment machinery, may be utilized during the operations phase. Heavy equipment use during O&M will be more infrequent than during construction and would typically be needed to address occasional unplanned failures. The O&M facility and any potential warehouses will likely use electric forklifts and flatbed trucks to transport components. The Projects may also purchase one or more small trucks or sports utility vehicles for shared staff use.

Approximately 5 to 11 vessels are expected to operate in the Offshore Project Area at any given time during normal O&M activities, though additional vessels (a maximum of up to 22 vessels) may be required in other maintenance or repair scenarios. Depending on whether SOVs or CTVs are primarily used, Atlantic Shores estimates that approximately 550 to 2,050 vessel round trips to the Offshore Project Area will occur annually during the Projects' operations, which is an average of two to six vessel trips per day. These vessel trips may be supplemented by helicopters to assist in personnel transport. The actual level of vessel activity during O&M will depend on the specific maintenance needs that develop as well as the final design of the offshore facilities.



## 6.0 Decommissioning

Decommissioning will broadly occur in the reverse order of construction and will be conducted in accordance with the applicable requirements discussed in Section 6.1.

### 6.1 Decommissioning Requirements

The Atlantic Shores Project Companies will follow the decommissioning requirements stated in Section 13, "Removal of Property and Restoration of the Leased Area on Termination of Lease," of the December 4, 2018 Lease Agreement for Lease Area OCS-A 0499. Pursuant to the applicable regulations in 30 CFR §585.902, and unless otherwise authorized by the Bureau of Ocean Energy Management (BOEM) under 30 CFR §585.909, Atlantic Shores Project Companies will be required to remove or decommission all facilities, projects, cables, pipelines, and obstructions and clear the seabed of all obstructions created by activities on the leased area, including any project easements(s). Removal or decommissioning activities must be completed within two years after lease termination (whether by expiration, cancellation, contraction, or relinquishment) in accordance with an approved Site Assessment Plan (SAP), Construction and Operations Plan (COP), or approved Decommissioning Application and applicable regulations in 30 CFR Part 585. Per 30 CFR §585.910(a), all offshore facilities must be removed to 15 feet (ft) (4.5 meters [m]) below the mudline, unless otherwise authorized by BOEM.

Atlantic Shores Project Companies will submit a Decommissioning Application to BOEM prior to decommissioning any Projects' facilities. BOEM's process for reviewing and approving this plan will include consultations with municipal, state, and federal agencies, other stakeholders, and the public.

### 6.2 Decommissioning Activities

The anticipated decommissioning process for each Project component is described in the following sections. Vessels used to complete offshore decommissioning activities will likely resemble those used during installation and could include jack-up vessels, heavy-lift vessels, and support vessels such as tugboats and crew transfer vessels (CTVs) (see Section 4.10.1). For onshore decommissioning activities, equipment will likely include truck-mounted winches, cable reels, and cable reel transport trucks.

When possible, the Projects' components removed during decommissioning will be recycled (e.g., steel foundation components). However, some materials may have no scrap value or capability to be recycled (e.g., fiberglass wind turbine generator [WTG] components); these materials would be broken down and disposed of at an approved onshore solid waste facility.

After the Projects' offshore facilities are removed, Atlantic Shores Project Companies will verify site clearance in accordance with 30 CFR §585.910(b).

## 6.2.1 WTGs

WTG components will be drained of any fluids and chemicals according to the established operations and maintenance (O&M) procedures and the Oil Spill Response Plan (OSRP) (see Section 1.5.3.2), which will be collected and properly disposed of or recycled. Before removing the WTGs, inter-array cables will be disconnected. WTG components will then be disassembled and removed from their foundations, shipped to shore, and recycled or scrapped. Removing the WTG blades, rotor, nacelle, and tower will involve the use of vessels with cranes that are similar to those utilized for installation and assembly.

## 6.2.2 Offshore Substations

Similar to WTGs, before offshore substation (OSS) decommissioning activities commence, any export cables, inter-array cables, and inter-link cables will be disconnected from the OSS. The OSS topsides will then be disassembled and removed from their foundations using cranes, shipped to shore, and recycled or scrapped. In accordance with the OSRP, OSS equipment will be drained of any fluids and chemicals, which will be collected and then properly disposed of or recycled. Any sulfur hexafluoride (SF<sub>6</sub>) in gas-insulated switchgear will be carefully removed for reuse.

## 6.2.3 WTG and OSS Foundations

The procedures used for decommissioning the WTG and OSS foundations will depend on the type of foundation:

- **Piled foundations:** These foundation types will be cut below the mudline and will be completely removed above that cut. To facilitate cutting, any sediment within the piles will be suctioned out and collected; after foundation removal, any collected sediment will be placed in the depression left after removal using a vacuum pump and diver or remotely-operated vehicle (ROV)-assisted hoses to minimize turbidity. Cutting steel foundations will likely be accomplished with underwater acetylene cutting torches, mechanical cutting, and/or a high-pressure water jet. Once cut, a crane will lift the foundation onto a vessel for transport to port; a foundation may be cut into multiple sections for ease of transport.
- **Suction bucket foundations:** Injecting water into the suction buckets will essentially reverse the installation process, pushing them back out of the seabed sediment and enabling complete removal of these foundations.
- **Gravity foundations:** Ballast within the foundations will be removed and the foundations will be floated away from the installation site. If it is not possible to re-float the gravity foundation, it will be disassembled on-site, and all components will be removed.

It is possible that, pending environmental assessment and regulatory approval, some foundations may be left in place as artificial reefs. In addition, scour protection around foundations may be removed or left in place pending future environmental assessment. If it is determined that scour protection needs to be removed, it will be excavated with a dredging vessel or removed by vessel's crane and transported to port for reuse or disposal.

#### 6.2.4 Offshore Cables

Export cables, inter-array cables, and inter-link cables (if present) will either be retired in place or removed from the seabed. The decision regarding whether to remove these cables and any overlying cable protection will be made based on future environmental assessments and consultations with federal, state, and municipal resource agencies. For example, if cable protection is functioning as reef habitat, it may be less disruptive and more beneficial to leave such structure undisturbed on the seabed.

If it is determined that offshore cables should be removed from the seabed, any overlying cable protection will need to be removed first, then the cables will be extracted from the seabed. Where these cables are buried in dense sediments, it may be necessary to fluidize overlying sediments before extracting the cables. Cables freed from the seabed will be coiled onto reels or cut into manageable lengths and transported to port for recycling.

#### 6.2.5 Met Tower

Similar to WTGs and OSS topsides, the meteorological (met) tower will be disassembled and removed from its foundation using cranes, shipped to shore, and recycled or scrapped. Decommissioning of the met tower's foundation will follow the steps outlined in Section 6.2.3.

#### 6.2.6 Onshore Facilities

Depending largely on future consultations with state and municipal agencies, onshore facilities (e.g., onshore substations and buried duct banks) will either be retired in place or reused for other purposes. For example, because removing buried concrete duct banks would require excavations similar to those involved with installation, leaving these conduits in place for other infrastructure could be less disruptive and beneficial. Even if duct banks are left in place for future use, the onshore cables will likely be removed from the conduits and recycled accordingly.

### 6.3 Financial Assurance for Decommissioning

Financial assurance for the Project will be provided in accordance with the terms and conditions required by BOEM in the Lease Agreement for Lease Area OCS-A 0499 and applicable requirements under 30 CFR Part 585, Subpart E.

## 7.0 Chemical Products and Solid and Liquid Wastes

Construction and operations and maintenance (O&M) activities will generate some quantity of solid and liquid wastes. Wastes and chemical products can be categorized as either hazardous or non-hazardous. Hazardous waste can include, but is not limited to, waste oils and oily materials (e.g., grease tubes, oily rags, oil filters), lead-acid batteries, aerosol cans, paints, varnishes, cleaners, solvents, and adhesives.

The Projects' solid and liquid wastes will be treated, released, stored, and/or disposed of in accordance with applicable federal, state, and local regulations. Vessels may discharge some liquid wastes (e.g., domestic water, uncontaminated bilge water and ballast water, treated deck drainage and sumps, and uncontaminated fresh or seawater from vessel air conditioning). Other waste, such as sewage, solid waste or chemicals, solvents, oils and greases from equipment, vessels or facilities will be stored and properly disposed of onshore or incinerated offshore. All vessels for the Projects will comply with the U.S. Coast Guard's (USCG's) waste and ballast water management regulations found at 33 CFR Part 151 and USCG's oil and hazardous material pollution prevention regulations found at 33 CFR Part 155, among other regulations. Project vessels covered under the Environmental Protection Agency's (EPA's) National Pollutant Discharge Elimination System (NPDES) Vessel General Permit (VGP) are also subject to the effluent limits in Section 2 of the VGP, which incorporate numerous regulations including, but not limited to, 40 CFR Part 110, 40 CFR Part 116, 40 CFR Part 117, and 33 CFR 151.10. Atlantic Shores will also require offshore contractors to participate in a marine trash and debris prevention training program.

All onshore waste likely to cause environmental harm will be stored in containers placed in designated, secure, and bermed locations away from depressions and drainage lines that carry surface water until collected by the selected waste contractor. Spill kits will be provided at all locations where hazardous materials are held to control foreseeable spills, and protocols will be in place to minimize the chance of such spills (see Section 1.5.3.2). Waste required to be removed for use away from storage areas will be kept in portable bunds (temporary spill berms), and waste oils will be recycled where appropriate.

Table 7.0-1 through Table 7.0-3 provide examples of potential chemical products to be used on the wind turbine generators (WTGs) and offshore substations (OSSs) as well as at the onshore substations. As each Project's design and planning progress, a detailed chemical and waste management plan will be developed. This plan will describe waste streams, storage and handling, and plans for proper disposal, recovery, recycling, or reuse. Atlantic Shores currently anticipates that chemical products for the WTGs, OSSs, and onshore substations will be included in the equipment at the time of installation. During O&M, chemical transfer will occur during certain activities, such as oil changes or replenishing fuel for emergency generators. As described in Section 1.5.3.2, spill response plans for the Projects' onshore and offshore facilities will be developed that outline spill prevention measures as well as provisions for containment, removal, and mitigation of spills.

Table 7.0-1 List of Potential Chemical Products Used for WTGs

Component	Description	Approximate Quantity per WTG		Approximate Total Quantity for Project 1 and Project 2 (200 WTGs)	
		Gallons	Liters	Gallons	Liters
Emergency generator fuel	Diesel fuel	400	1,514	80,000	302,833
Hydraulic systems	Hydraulic fluid	350	1,325	70,000	264,979
Yaw/pitch system grease	Grease	150	568	30,000	113,562
Drive train, yaw, pitch system	Gear and bearing lubricating oil	500	1,893	100,000	378,541
Gearbox	Gear and bearing lubricating oil	581	2,199	116,200	439,865
Transformer	Biodegradable dielectric insulating fluid/synthetic ester oil	1,800	6,814	360,000	1,362,748
Hydraulic accumulators	Nitrogen	21,134	80,000	4,226,753	16,000,000
Equipment cooling system	Water/glycol	400	1,514	80,000	302,833
Passive tower damper system	Water/glycol	3,700	14,006	740,000	2,801,205
Component	Description	Pounds	Kilograms	Pounds	Kilograms
Switchgear	Electrical insulator/arc suppressor	243	110	48,502	22,000

Table 7.0-2 List of Potential Chemical Products Used for OSSs

Component	Description	Approximate Quantity per Small OSS		Approximate Quantity per Medium OSS		Approximate Quantity per Large OSS	
		Gallons	Liters	Gallons	Liters	Gallons	Liters
Diesel fuel storage	Diesel fuel	7,500	28,391	12,000	45,425	20,000	75,708
Diesel engines	Internal motor lubrication	5	19	10	38	15	57
Main power transformers, earthing transformers	Biodegradable dielectric insulating fluid, mineral oil, or synthetic ester oil	26,000	98,421	78,000	295,262	130,000	492,104
Reactors	Biodegradable dielectric insulating fluid, mineral oil, or synthetic ester oil	11,000	41,640	33,000	124,919	55,000	208,198
Uninterruptible power supply (UPS) batteries	Electrolyte inside lead/acid batteries or valve-regulated lead acid battery	250	946	400	1,514	400	1,514
Fire suppressant for electrical equipment without oil	Firefighting	676	2,560	1,014	3,840	1,353	5,120
Firefighting aid	Aqueous film-forming foam and water mixtures at 3% by volume	3,500	13,249	4,000	15,142	5,000	18,927
Diesel engine cooling	Water/glycol	30	114	50	189	50	189
Equipment Cooling System	Water/glycol	1,000	3,785	2,000	7,571	3,000	11,356
Component	Description	Pounds	Kilograms	Pounds	Kilograms	Pounds	Kilograms
Switchgear	Electrical insulator/arc suppressor	3,307	1,500	9,480	4,300	9,480	4,300
Air conditioning/condensers	Refrigerant	198	90	397	180	794	360

Table 7.0-3 List of Potential Chemical Products Used for Onshore Substations

Component	Description	Approximate Quantity per Onshore Substation	
		Gallons	Liters
Diesel fuel storage	Diesel fuel	1,500	5,678
Diesel engines	Internal motor lubrication	10	38
Main power transformers, earthing transformers	Biodegradable dielectric insulating fluid, mineral oil, or synthetic ester oil	162,500	615,129
Reactors	Biodegradable dielectric insulating fluid, mineral oil, or synthetic ester oil	110,000	416,395
UPS batteries	Electrolyte inside lead/acid batteries or valve-regulated lead acid battery	400	1,514
Diesel engine cooling	Water/glycol	25	95
Equipment cooling system	Water/glycol	1,250	4,732
Component	Description	Pounds	Kilograms
Switchgear	Electrical insulator/arc suppressor	11,023	5,000
Air conditioning/condensers	Refrigerant	794	360

## 8.0 References

- [AREC and AWS] Atlantic Renewable Energy Corporation, AWS Scientific, Inc. 2004. New Jersey offshore wind energy: Feasibility study. Final Version. <http://www.njcleanenergy.com/files/file/FinalNewJersey.pdf>
- [BOEM] Bureau of Ocean Energy Management. 2012. Commercial wind lease issuance and site assessment activities on the Atlantic Outer Continental Shelf offshore Rhode Island and Massachusetts: Environmental Assessment. [https://www.boem.gov/sites/default/files/uploadedFiles/BOEM/Renewable\\_Energy\\_Program/State\\_Activities/BOEM\\_RI\\_MA\\_EA\\_2012-070\\_719.pdf](https://www.boem.gov/sites/default/files/uploadedFiles/BOEM/Renewable_Energy_Program/State_Activities/BOEM_RI_MA_EA_2012-070_719.pdf)
- [BOEM] Bureau of Ocean Energy Management. 2018. Draft guidance regarding the use of a project design envelope in a construction and operations plan. <https://www.boem.gov/sites/default/files/renewable-energy-program/Draft-Design-Envelope-Guidance.pdf>
- [BOEM] Bureau of Ocean Energy Management. 2020. Vineyard Wind 1 offshore wind energy project supplement to the Draft Environmental Impact Statement. <https://www.boem.gov/sites/default/files/documents/renewable-energy/Vineyard-Wind-1-Supplement-to-EIS.pdf>
- [BYNDC] Brooklyn Navy Yard. c2020. Brooklyn Navy Yard. [accessed 2020 July 20]. <https://brooklynnavyard.org/>.
- [EPA] Environmental Protection Agency. 2020. Emissions & Generation Resource Integrated Database (eGRID) eGRID2018. [accessed 2021 January 20]. <https://www.epa.gov/energy/emissions-generation-resource-integrated-database-egrid>
- [GCT] Global Container Terminals Inc. c2020. GCT New York. [accessed 2020 July 20]. <https://globalterminals.com/terminals/>.
- [GMI] Geo-Marine, Inc. 2010. New Jersey Department of Environmental Protection baseline studies final report: Volume I: Overview, summary, and application. [https://www.nj.gov/dep/dsr/ocean-wind/Ocean%20Wind%20Power%20Ecological%20Baseline%20Studies\\_Volume%20One.pdf](https://www.nj.gov/dep/dsr/ocean-wind/Ocean%20Wind%20Power%20Ecological%20Baseline%20Studies_Volume%20One.pdf)
- [IRENA] International Renewable Energy Agency. 2019. Future of wind: Deployment, investment, technology, grid integration and socio-economic aspects (A Global Energy Transformation paper), International Renewable Energy Agency, Abu Dhabi. [https://www.irena.org/-/media/Files/IRENA/Agency/Publication/2019/Oct/IRENA\\_Future\\_of\\_wind\\_2019.pdf](https://www.irena.org/-/media/Files/IRENA/Agency/Publication/2019/Oct/IRENA_Future_of_wind_2019.pdf)



- [MMS] U.S. Department of the Interior, Minerals Management Service. 2004. Review of existing and emerging environmentally friendly offshore dredging technologies. OCS Report MMS 2004-076. <https://www.boem.gov/sites/default/files/non-energy-minerals/2004-076.pdf>
- [NJBPU] New Jersey Board of Public Utilities. 2020. NJBPU takes major steps forward for offshore wind in New Jersey. [accessed 2021 January 28]. <https://www.nj.gov/bpu/newsroom/2020/approved/20200909a.html>.
- [NJDEP] New Jersey Department of Environmental Protection. 2020. New Jersey Global Warming Response Act 80x50 report: Evaluating our progress and identifying pathways to reduce emissions 80% by 20250. <https://www.nj.gov/dep/climatechange/docs/nj-gwra-80x50-report-2020.pdf>
- [USCG] U.S. Coast Guard. 2020a. The Areas Offshore of Massachusetts and Rhode Island Port Access Route Study. Final Report, 14 May 2020. USCG-2019-0131.
- [USCG] U.S. Coast Guard. 2020b. Shipping Safety Fairways Along the Atlantic Coast. Advanced Notice of Rule Making. 33 CFR Part 166. Document No. USCG-2019-0279.
- [WHO] World Health Organization. 2021. Climate change and human health: WHO calls for urgent action to protect health from climate change – Sign the call. [accessed 2021 February 15]. <https://www.who.int/globalchange/global-campaign/cop21/en/>
- Atlantic Offshore Terminals. c2020. Arthur Kill Terminal. [accessed 2020 July 20]. <https://www.atlanticterminals.com/projects.html>.
- Azavea. 2020. Last Tow: Fishing Route Analytics Report.
- Brayton Point LLC. c2019. Brayton Point Commerce Center. [accessed 2020 July 20]. <http://www.braytonpointcommercecenter.com/>.
- Carr-Harris, Andrew and Corey Lang. 2019. Sustainability and tourism: the effect of the United States' first offshore wind farm on the vacation rental mark. Resource and Energy Economics, Volume 57, August 2019, Pages 51-67.
- Connecticut Port Authority. c2019. Connecticut Port Authority. [accessed 2020 July 20]. <https://ctportauthority.com/about-us/port-of-bridgeport/>.
- COWI North America, Inc. 2019. 2018 Ports Assessment: Port Ivory. [accessed 7/24]. Prepared for New York State Energy Research and Development Authority.
- COWI North America, Inc. 2017. Assessment of ports and infrastructure. [accessed 7/29]. Prepared for New York State Energy Research and Development Authority.

- DNV GL. 2016. Recommended practice: Subsea power cables in shallow water. <http://rules.dnvgl.com/docs/pdf/dnvgl/RP/2016-03/DNVGL-RP-0360.pdf>
- Green City Times. 2020. Offshore wind farms in the United States: Block Island leads the way. [accessed 2021 January 20]. <https://www.greencitytimes.com/the-block-island-wind-farm/>
- GT USA Wilmington, LLC. c2020. The Port of Wilmington. [accessed 2020 July 20]. <https://www.portofwilmington.com/>.
- ICF. 2020. Comparison of Environmental Effects from Different Offshore Wind Turbine Foundations. Prepared for: U.S. Dept. of the Interior, Bureau of Ocean Energy Management. Sterling, Virginia. OCS Study BOEM 2020-041.
- Kassel R. 2020. State of the Environmental City: Making New York City the hub of New York's offshore wind industry. Capalino+Company; [accessed 2020 July 20]. <https://www.capalino.com/state-of-the-environmental-city-making-new-york-city-the-hub-of-new-yorks-offshore-wind-industry/>.
- Leonhard SB, Stenberg C, StØttrup J. 2011. Effect of the Horns Rev 1 Offshore Wind Farm on Fish Communities Follow-up Seven Years after Construction. DTU Aqua Report No 246-2011.
- Parson, George, Jeremy Firestone, Lingxiao Yan, and Jenna Toussaint, 2020. The effect of offshore wind power Projects on recreational beach use on the east coast of the United States; Evidence from contingent-behavior data. Published in Energy Policy, Volume 144, September 2020, 111659.
- PNCT. c2020. PNCT terminal information. [accessed 2020 July 17]. <https://www.pnct.net/>.
- Port of Albany. c2019. Port of Albany. [accessed 2020 July 17]. <https://www.portofalbany.us/>.
- Port of Coeymans, Inc. c2020. Port of Coeymans Marine Terminal. [accessed 2020 July 17]. <http://portofcoeymans.com/>.
- Port of New Bedford. c2018. Marine Commerce Terminal Port of New Bedford. [accessed 2020 July 20]. <https://portofnewbedford.org/marine-commerce-terminal/>.
- Ramboll. 2020. New Jersey offshore wind strategic plan: Navigating our future. [https://www.nj.gov/bpu/pdf/Final\\_NJ\\_OWSP\\_9-9-20.pdf](https://www.nj.gov/bpu/pdf/Final_NJ_OWSP_9-9-20.pdf)
- South Jersey Port Corporation. c2020. Paulsboro Marine Terminal. [accessed 2020 July 17]. <https://www.southjerseyport.com/facilities/paulsboro-marine-terminal/>.
- State of New Jersey. c1996-2020. New Jersey Wind Port. [accessed 2020 July 20]. <https://nj.gov/windport/>.

- Tradepoint Atlantic. c2020. Redwood Capital Investments. [accessed 2020 July 20]. <https://www.tradepointatlantic.com/>.
- Vineyard Wind. 2020. Vineyard Wind selects GE Renewable Energy as preferred turbine supplier for America's First utility scale offshore wind project. [accessed 2021 January 20]. <https://www.vineyardwind.com/press-releases/2020/12/1/vineyard-wind-selects-ge-renewable-energy-as-preferred-turbine-supplier>
- Virginia Port Authority. c2020. Portsmouth Marine Terminal. [accessed 2020 July 20]. <http://www.portofvirginia.com/facilities/portsmouth-marine-terminal-pmt/>.
- Windfair. 2020. Dominion Energy completes construction of first offshore wind project in U.S. federal waters. [accessed 2021 January 20]. <https://w3.windfair.net/wind-energy/pr/34899-dominion-energy-developer-offshore-wind-turbine-usa-federal-water-pilot-project-electricity-costs-carbon-emissions-economy-jobs-virginia-cvow>
- The White House. 2021. Executive Order on Tackling the Climate Crisis at Home and Abroad. <https://www.whitehouse.gov/briefing-room/presidential-actions/2021/01/27/executive-order-on-tackling-the-climate-crisis-at-home-and-abroad/>