

Construction & Operations Plan

Sunrise Wind Farm Project

Executive Summary, Introduction, Project Siting
and Design Development, Description of
Proposed Activity, Site Characterization and
Assessment of Impacts, References

August 23, 2021

Submitted to



BUREAU OF OCEAN ENERGY MANAGEMENT

Submitted by

**Sunrise
Wind**

Powered by
Ørsted &
Eversource

Prepared by



This page intentionally left blank

Sunrise Wind Farm Project

Construction and Operations Plan

August 23, 2021

Initial Submission to BOEM September 1, 2020

Submitted to: Bureau of Ocean Energy Management
45600 Woodland Road
Sterling, VA 20166

Submitted by: Sunrise Wind LLC
437 Madison Avenue, Suite 1903
New York, NY 10022

Prepared by: Stantec Consulting Services Inc.
61 Commercial Street, Suite 100
Rochester, NY 14614

With Support from: AKRF, Inc.
Capital Airspace Group
DNV GL
Environmental Design & Research, DPC
Exponent
Holland & Knight LLP
INSPIRE Environmental
JASCO Applied Sciences
R. Christopher Goodwin & Associates
The Public Archaeology Laboratory, Inc.
TRC
VHB
Woods Hole Group

**Sunrise
Wind**

Powered by
Ørsted &
Eversource

This page intentionally left blank

EXECUTIVE SUMMARY

Sunrise Wind LLC (Sunrise Wind) is submitting this Construction and Operations Plan (COP) to support the siting and development of the Sunrise Wind Farm (SRWF) and the Sunrise Wind Export Cable (SRWEC) (collectively, the Sunrise Wind Farm Project or Project). Sunrise Wind is a 50/50 joint venture between Orsted North America Inc. (Orsted NA) and Eversource Investment LLC (Eversource).

The wind farm portion of the Project (referred to as the Sunrise Wind Farm [SRWF]) will be located on the Outer Continental Shelf (OCS) in the designated Bureau of Ocean Energy Management (BOEM) Renewable Energy Lease Area OCS-A 0487 (Lease Area).¹ The Lease Area is approximately 18.9 statute miles (mi) (16.4 nautical miles [nm], 30.4 kilometers [km]) south of Martha's Vineyard, Massachusetts, approximately 30.5 mi (26.5 nm, 48.1 km) east of Montauk, New York, and 16.7 mi (14.5 nm, 26.8 km) from Block Island, Rhode Island (Figure ES-1 and Figure ES-2). The Lease Area contains portions of areas that were originally awarded through the BOEM competitive renewable energy lease auctions of the Wind Energy Areas (WEA) off the shores of Rhode Island and Massachusetts. Other components of the Project will be located on the OCS, in state waters of New York, and onshore in the Town of Brookhaven, Long Island, New York. The proposed interconnection location for the Project is the Holbrook Substation.

The Project is defined in this COP using a Project Design Envelope (PDE) approach. The PDE defines “a reasonable range of project designs” associated with various components of a project (e.g., foundation and wind turbine generator [WTG] options) (BOEM 2018). The PDE is used to assess the potential maximum impacts on key environmental and human use resources (e.g., marine mammals, fish, benthic habitats, commercial fisheries, and navigation), focusing on the design parameter (within the defined range) that represents the greatest potential impact (i.e., the maximum design scenario) for each unique resource. The PDE for the Project is based on a generating capacity ranging between 880 megawatts (MW) and 1,300 MW with power transmitted to shore on direct current (DC) submarine cables. The Project includes the following primary assumptions:

- Onshore:
 - Onshore Transmission Cable, transition joint bays (TJBs) and concrete and/or direct buried joint bays and associated components;
 - Onshore Interconnection Cable;
 - Fiber optic cable co-located with the Onshore Transmission and Onshore Interconnection Cables; and
 - One Onshore Converter Station (OnCS–DC).

¹ A portion of Lease Area OCS-A 0500 (Bay State Wind LLC) and the entirety of Lease Area OCS-A 0487 (formerly Deepwater Wind New England LLC) were assigned to Sunrise Wind LLC on September 3, 2020, and the two areas were merged and a revised Lease OCS-A 0487 was issued on March 15, 2021. Thus, when using the term “Lease Area” within this COP, Sunrise Wind is referring to the new merged Lease Area OCS-A 0487.

CONSTRUCTION AND OPERATIONS PLAN

- Offshore:
 - Up to 122 WTGs;
 - Up to 123 foundations (for WTGs and an Offshore Converter Station [OCS–DC]);
 - Up to 186 mi (300 km) of IAC;
 - One OCS–DC; and
 - One DC SRWEC located within an up to 106 mi (170 km)-long corridor.

The Project will be commissioned and operational by end of Q4 2025. Sunrise Wind assumes all permits will be obtained by Q3 2023, to allow for final engineering and design, contract negotiations, procurement, and manufacturing prior to installation. It is further assumed construction will begin in Q3 2023, with installation of the onshore components and initiation of seafloor preparation activities (clearing of debris and obstructions). Offshore installation is anticipated to begin in Q2 2024.

The Project components and locations presented in this COP and shown on Figure ES-1 and Figure ES-2 have been selected based on environmental and engineering site characterization studies completed to date and will be refined in the Facility Design Report (FDR) and Fabrication and Installation Report (FIR), which will be reviewed by BOEM pursuant to Title 30 of the Code of Federal Regulations (CFR) Parts 585.700-702 before the commencement of installation. In addition, a Certified Verification Agent (CVA), approved by BOEM, will conduct an independent assessment, and verify that the Project components are fabricated and installed in accordance with both this COP and the FDR/FIR.

V:\1956\active_Task Owner and other Non-BC1956_Jobs\2028113199\03_data\gis_ced\gis\MapDocs\COP\Executive Summary\2028113199_ES-1_ProjectOffshore.mxd Revised: 2021-05-21 By: gearpenitler

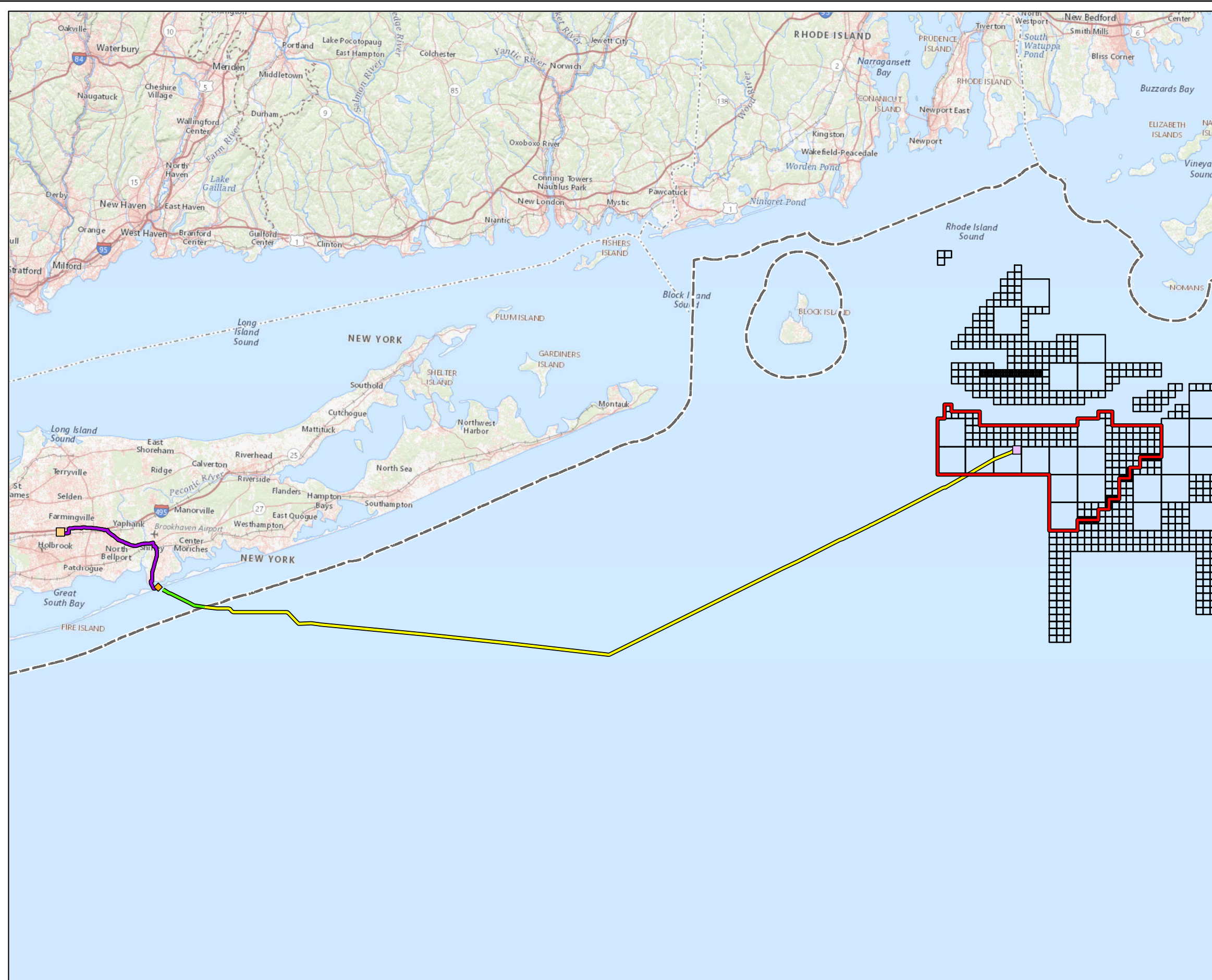

**Figure ES-1
Project Location**

Sunrise Wind | Powered by Ørsted & Eversource

- Legend**
- Sunrise Wind Farm (SRWF)
 - Offshore Converter Station (OCS-DC)
 - ◆ SRWEC Landfall Location
 - Onshore Converter Station (OnCS-DC)
 - Sunrise Wind Export Cable (SRWEC-OCS)
 - Sunrise Wind Export Cable (SRWEC-NYS)
 - Onshore Transmission Cable
 - LIE Service Road Route
 - 3-nm State Waters Boundary
 - BOEM OCS Lease Block

Note
Routes are indicative and subject to engineering design changes.

Sources
1. Base map: USGS The National Map

Date	12/18/2020 Revised: 6/1/2021
Project Number	2028113199
Prepared By	PB
Reviewed By	LJ

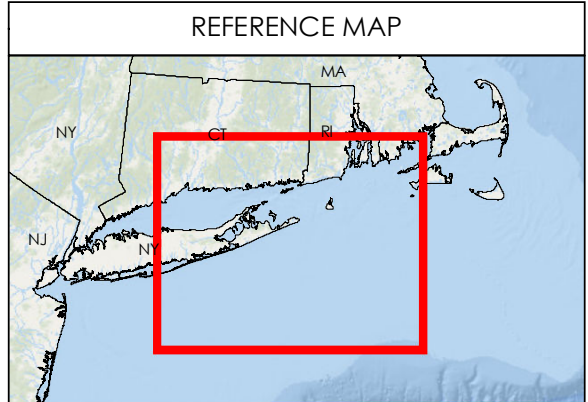
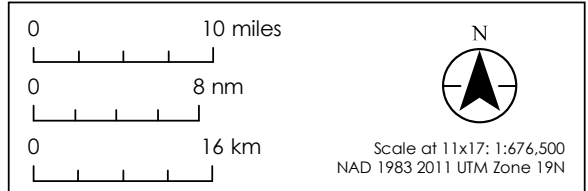

This page intentionally left blank

V:\1956\active\Task Owner and other Non-BC\1956_Jobs\2028113199_03_data\gis_ced\gis\mxds\COP\Executive Summary\2028113199_ES_2_ProjectOnshore.mxd Revised: 2021-05-21 By: garpenster

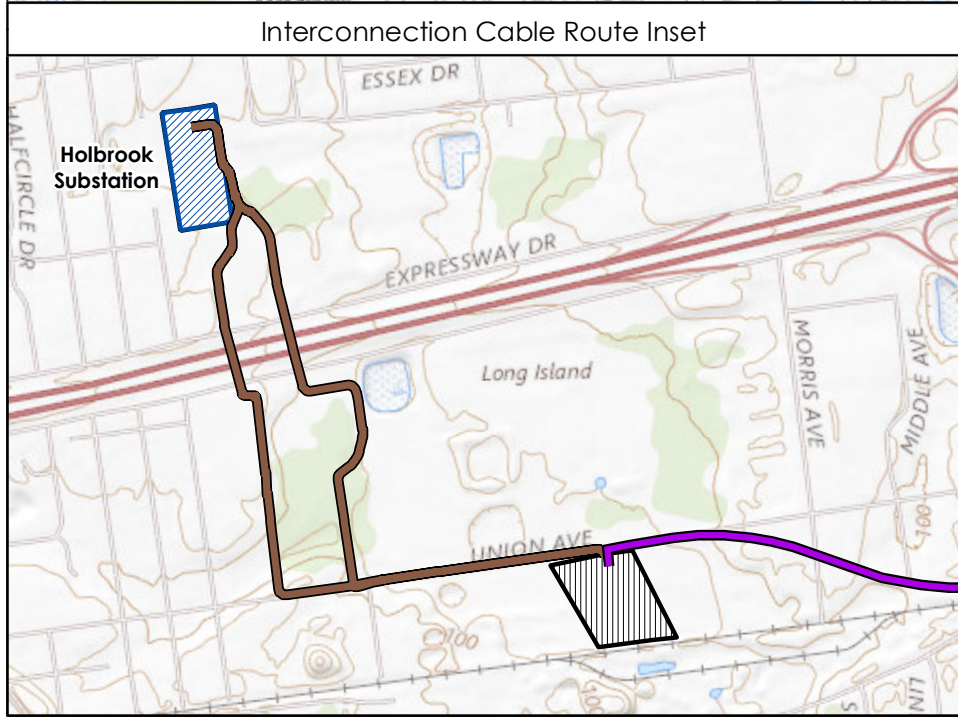
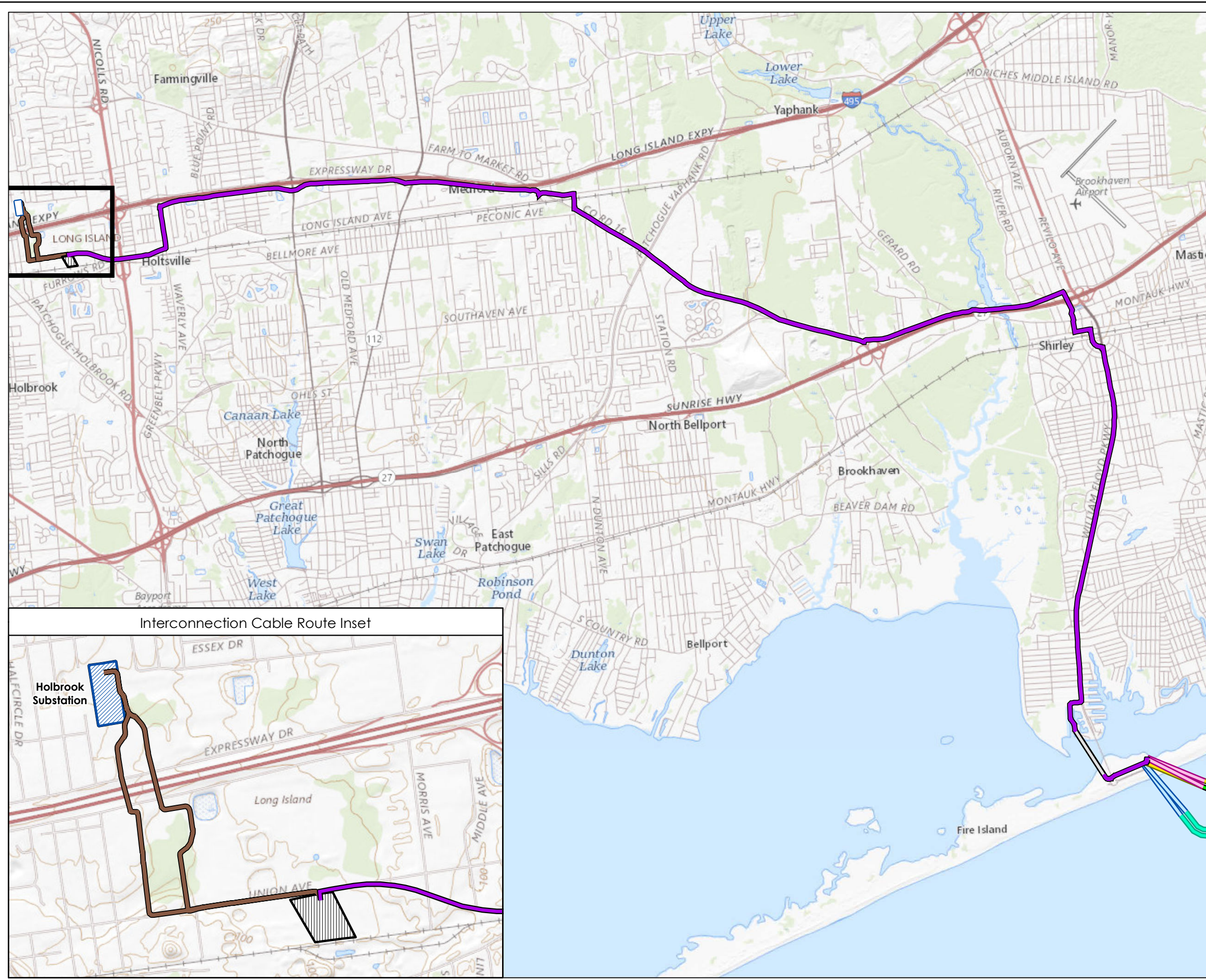

**Figure ES-2
Onshore Facilities**

Sunrise Wind | Powered by Ørsted & Eversource

- Legend**
- Sunrise Wind Farm (SRWF)
 - Sunrise Wind Export Cable (SRWEC-OCS)
 - Sunrise Wind Export Cable (SRWEC-NYS)
 - SRWEC-NYS (Western Landfall Option)
 - Landfall HDD A
 - Landfall HDD B
 - Landfall HDD C
 - Intracoastal Waterway HDD (ICW HDD)
 - Onshore Transmission Cable
 - LIE Service Road Route
 - Onshore Interconnection Cable Route
 - Union Avenue Site / Onshore Converter Station (OnCS-DC)
 - Holbrook Substation

Notes
1. SRWEC route will have one landfall location. Routes are indicative and subject to engineering design changes.

Sources
Base map: USGS The National Map

Date	12/18/2020 Revised: 6/1/2021
Project Number	2028113199
Prepared By	PB
Reviewed By	LJ

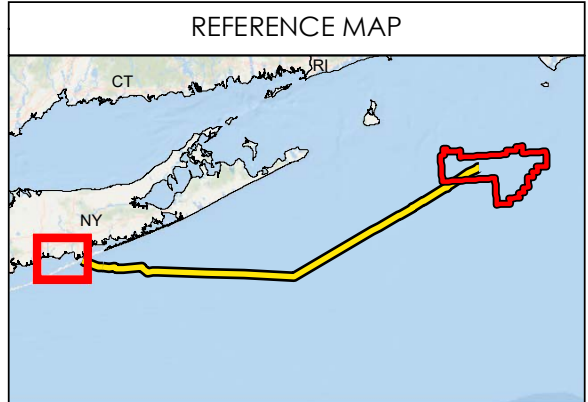
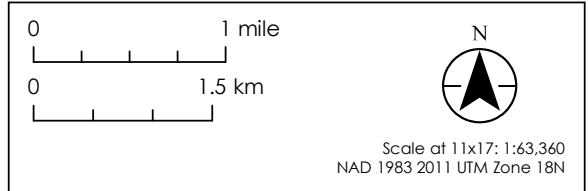

This page intentionally left blank

CONSTRUCTION AND OPERATIONS PLAN

The Project will provide clean, reliable offshore wind energy that will increase the amount and availability of renewable energy to New York while creating the opportunity to displace electricity generated by fossil fuel-powered plants and offering substantial economic and environmental benefits. New York has adopted substantial renewable portfolio standards and clean energy targets to address issues associated with climate change, highlighting the current and future demand for this Project.

In response to the expressed need and demand, Sunrise Wind executed a contract with NYSEERDA for a 25-year OREC Agreement in October 2019. Under the OREC Agreement, NYSEERDA will purchase ORECs for 880 MW of offshore wind energy, with the ability to increase by 5 percent without requiring an amendment (totaling up to 924 MW), generated by the operational Project and make them available for purchase by New York load-serving entities. The Project is being developed to fulfill its obligations to New York in accordance with its OREC Agreement. As specified in the OREC Agreement, the Project will generate electricity from an offshore wind farm located in the Lease Area for transmission and delivery to the LIPA Holbrook Substation. The Project will include up to 122 WTG, IAC, one OCS-DC, and one direct current SRWEC making landfall in the Town of Brookhaven, New York.

In addition to the 924 MW contracted to NYSEERDA, Sunrise Wind has the opportunity to enter into other potential offtake agreements or sell additional electricity on a merchant basis without an offtake contract. Sunrise Wind is currently working with suppliers to determine the maximum capacity of the DC transmission system, and with the New York Independent System Operator to confirm the maximum interconnection capacity limits at the Holbrook Substation. Depending on the technical limitations of the DC transmission system, as well as the technical limitations for injecting power at the Holbrook Substation, the total nameplate capacity of the Project, inclusive of the 924 MW contracted to NYSEERDA, could be up to 1,300 MW. Thus, the PDE for the Project described in Section 1.2 and Section 3 is based on an operating capacity ranging between 880 MW and 1,300 MW. If additional offtake contracts are signed or a decision is made to sell on a merchant basis, the additional capacity (up to 376 MW) would be installed during a single campaign with the 924 MW contracted to NYSEERDA.

As such, the Project will help the State achieve the aggressive clean energy goals set forth in REV, the CES and more recently, the *Climate Leadership and Community Protection Act* (CLCPA), which was signed in July 2019 and adopts the most ambitious and comprehensive climate and clean energy legislation in the country. The CLCPA sets forth an ambitious plan that sets the NYS goal of achieving 100 percent carbon-free electricity by 2040 and 70 percent of electricity from renewable sources by 2030, including a target of reaching 9,000 MW of offshore wind by 2035.

This COP includes the following information:

- An overview of the Project, including a summary of the PDF, details on the regulatory framework in which the Project will be reviewed, a description of the agency and stakeholder outreach, and other key Project information requested by BOEM (Section 1);
- A summary of the siting and routing selection processes for the Project, including the siting history, and discussion of siting, design, and construction alternatives considered during Project development (Section 2);

CONSTRUCTION AND OPERATIONS PLAN

- A description of proposed activity, including infrastructure and schedule for all onshore and offshore Project components, as well as detailed description of design and construction, commissioning, operations and maintenance (O&M), and conceptual decommissioning activities. (Section 3); and
- A characterization and assessment of potential impacts during construction, O&M, and decommissioning activities, which will support relevant Project reviews and consultations (Section 4);
- A list of supporting references, organized by COP section (Section 5); and
- Additional supporting information provided in appendices (Appendix A to Appendix Y2).

This COP was prepared in accordance with 30 CFR § 585. BOEM is expected to be the lead federal agency under the *National Environmental Policy Act* (NEPA). Sunrise Wind has prepared consistency certifications for review by New York, Rhode Island, and Massachusetts to confirm consistency with each state's enforceable policies impacting any coastal use or resource. For activities related to the SRWEC–NYS and Onshore Facilities within the territory of the State of New York, the New York Public Service Commission (NYSPSC) will lead the review of the Project activities under Article VII of the New York Public Service Law, which will include review under Section 401 of the *Clean Water Act* (CWA).

The Article VII process provides a full review of the need for and environmental impact of the siting, design, construction, and operation of the SRWEC–NYS and Onshore Facilities and results in the issuance of a Certificate of Environmental Compatibility and Public Need (CECPN). The CECPN will include Water Quality Certification, pursuant to Section 401 of the CWA and Implementing Regulations (6 New York Codes, Rules and Regulations [NYCRR] Parts 701, 702, 704, 754 and Part 800 to 941); issuance of Protection of Waters Permit, pursuant to Article 15 (6 NYCRR Part 608 and 621), Freshwater Wetlands Permit, pursuant to Article 24 (6 NYCRR Part 663 – 665), and Tidal Wetlands Permit, pursuant to Article 25 (6 NYCRR Part 661). In the CECPN Application to the NYSPSC, Sunrise Wind will demonstrate compliance with electric and magnetic field standards for new transmission lines (NYSPSC, 1990) and with the Coastal Erosion Hazard Area Law (Article 34), administered by the Town of Brookhaven. Sunrise Wind has sited the Onshore Facilities to be consistent with the goals of the *Pine Barrens Protection Act* (Article 57), overseen by the Central Pine Barrens Joint Planning and Policy Commission, to the extent practicable. Sunrise Wind has coordinated with, and will continue to coordinate with, the Central Pine Barrens Joint Planning and Policy Commission and will request a Core Preservation Area Hardship Exemption from the Central Pine Barrens Joint Planning and Policy Commission based on compelling public need for the portion of the Onshore Facilities that will traverse the Central Pine Barrens.

CONSTRUCTION AND OPERATIONS PLAN

In addition to the federal and state level permits, the Project must also comply with applicable provisions of the *Endangered Species Act* (16 U.S.C. §§1531 et seq.), *Marine Mammals Protection Act* (16 U.S.C. §§ 1361 et seq.), the *Migratory Bird Treaty Act* (16 USC §§ 703 et seq.), the Magnuson-Stevens Fishery Conservation and Management Act (16 USC §§1801 et seq.), Section 106 of the *National Historic Preservation Act*, as amended (54 USC § 306.108), the *Clean Air Act* (42 USC § 7627), Section 404 of the *Clean Water Act* (33 USC § 1344), and Section 10, and Section 14 of the *Rivers & Harbors Act* (33 USC §§ 333, 403, 408).

Project activities that could impact resources were identified as Impact-Producing Factors (IPFs), which include seafloor and land disturbance; sediment suspension and deposition; noise; electric and magnetic fields (EMF); discharges and releases; trash and debris; traffic; air emissions; visible infrastructure; and lighting and marking. The type and degree of potential impacts from Project activities vary based on the characteristics of the resource and the IPF that may affect each resource. Potential impacts are characterized as direct or indirect – direct impacts are those occurring at the same place and time as the initial cause or action and indirect impacts are those that occur later in time or are spatially removed from the activity.

The anticipated duration of an impact and recovery time following the impact are also described, often qualitatively and in connection to the Project phase. For example, an impact may be described as temporary, and limited to a particular construction activity, with rapid recovery following the cessation of the activity. Alternatively, an impact may be described as existing for the duration of a particular phase, or over the entire life of the Project (i.e., 25 to 35 years).

Sunrise Wind has incorporated avoidance and minimization of environmental impacts throughout the site selection and design process. Table ES-1 identifies which potential IPFs may impact which resources and describes the corresponding environmental protection measures that Sunrise Wind will adopt to minimize these impacts. In addition, Sunrise Wind will carry out the environmental protection measures and BMPs described in further detail throughout Section 4.0. Although organized by resource in Table ES-1, many of the measures for one resource will indirectly benefit and/or protect other resources; for the sake of simplicity these measures are not necessarily repeated for all subsequent resources.

Most potential impacts to affected physical, biological, visual, cultural, socioeconomic, and transportation and navigation resources will be minimized and/or mitigated. Resources that may be impacted by the SRWF, SRWEC, and Onshore Facilities are expected to recover given that impacts will be limited temporally and/or spatially. Post-construction environmental monitoring of various resources will take place and will include, at a minimum, coordination and data sharing with regional monitoring efforts. Monitoring plans will be developed in coordination with the relevant agencies prior to construction.

This page intentionally left blank

Table ES-1 Summary of Potential Impacts and Environmental Protection Measures, by Resource

Resource	IPF Associated with Project	Environmental Protection Measures
Physical Oceanographic and Meteorological Conditions	<ul style="list-style-type: none"> Visible Infrastructure 	<ul style="list-style-type: none"> Potential impacts to physical oceanographic and meteorological conditions are considered negligible and, therefore, environmental protection measures are not necessary.
Geological Resources	<ul style="list-style-type: none"> Seafloor and Land Disturbance Sediment Suspension and Deposition 	<ul style="list-style-type: none"> The SRWF and SRWEC will avoid identified shallow hazards, to the extent feasible. To the extent feasible, installation of the SRWEC and IAC will occur using methods such as mechanical plow, jet plow, and/or mechanical cutter for installation of the IAC and SRWEC will minimize impacts to surficial geology, compared to open-cut dredging. Use of monopile and piled jacket foundations with associated scour protection will minimize impacts to surficial geology, compared to other foundation types. Dynamic positioning (DP) vessels will be used for installation of the IAC and SRWEC to the extent practicable. Use of DP vessels will minimize impacts to the seabed, compared to use of a vessel relying on multiple anchors. The SRWEC Landfall will be installed via horizontal directional drilling (HDD) to avoid impacts to the nearshore zones and surficial geologic resources. The Onshore Transmission Cable will also be installed via HDD under the Intracoastal Waterway (ICW) to avoid impacts to coastal resources; HDD and trenchless methods will also be used elsewhere onshore, where appropriate, to minimize impacts to surface locations and resource areas. Onshore Facilities are primarily sited within previously disturbed and developed areas (e.g., roadways, rights-of-way [ROW], developed industrial/commercial areas) to the extent feasible, to minimize impacts to undisturbed surficial geology. A Stormwater Pollution Prevention Plan (SWPPP), including erosion and sedimentation control best management practices (BMPs) and revegetation measures, will be implemented to minimize potential water quality impacts and limit sediment drift, transport, and deposition from construction and O&M of the Onshore Facilities.
Water Quality	<ul style="list-style-type: none"> Sediment Suspension and Deposition Discharges and Releases Trash and Debris 	<ul style="list-style-type: none"> Accidental spill or release of oils or other hazardous materials will be managed offshore through an Emergency Response Plan/Oil Spill Response Plan (ERP/OSRP) and onshore through a Spill Prevention, Control, and Countermeasure (SPCC) Plan. Sunrise Wind will require all construction and O&M vessels to comply with applicable International Convention for the Prevention of Pollution from Ships (IMO MARPOL), federal (USCG and EPA), and state regulations and standards for the management, treatment, discharge, and disposal of onboard solid and liquid wastes and the prevention and control of spills and discharges. Where HDD is utilized, an Inadvertent Return Plan will be prepared and implemented to minimize the potential risks associated with release of drilling fluids. Onshore construction activities will be conducted in compliance with the New York State Pollutant Discharge Elimination System (SPDES) General Permit for Stormwater Discharges associated with construction activities, and an approved SWPPP. An SWPPP, including erosion and sedimentation control BMPs and revegetation measures, will be implemented to minimize potential water quality impacts from construction and O&M of the Onshore Facilities.
Air Quality	<ul style="list-style-type: none"> Air Emissions 	<ul style="list-style-type: none"> Diesel generators on WTGs and the OCS-DC will only burn low sulfur diesel in the engines. Diesel generators on WTGs will only be used temporarily during commissioning or in an emergency power outage. Vessels meeting the definition of an OCS source and providing construction or maintenance services for the SRWF and SRWEC will use low sulfur fuel, Marine Distillate, or Marine Residual fuels when operating any diesel-fired emission unit, as specified by applicable regulations or OCS Permit conditions. Vessel engines will meet the applicable United States Environmental Protection Agency (EPA) air emission standards, as specified in the OCS Permit, to satisfy Best Available Control Technology (BACT) or Lowest Achievable Emission Rate (LAER). Onshore Facilities equipment and fuel suppliers will provide equipment and fuels that comply with the applicable EPA or equivalent emission standards. Potential fugitive emissions of particulate matter from onshore construction activities will be minimized by implementing dust control measures. Gas-insulated switchgears are manufactured to be completely sealed and would likely result in little or no SF6 emissions. Switchgears containing SF6 on the WTG, OCS-DC, and OnCS-DC will be equipped with integral low-pressure detectors to detect SF6 gas leakages should they occur. Sunrise Wind will obtain emission reduction credits to offset emissions from construction and O&M activities, if required as a condition of the OCS Permit.

CONSTRUCTION AND OPERATIONS PLAN

Resource	IPF Associated with Project	Environmental Protection Measures
Coastal and Terrestrial Habitat	<ul style="list-style-type: none"> • Seafloor and Land Disturbance • Sediment Suspension and Deposition • Discharges and Releases • Trash and Debris: Potential Impact • Traffic 	<ul style="list-style-type: none"> • The SRWEC Landfall will be installed via horizontal directional drilling (HDD) to avoid impacts to the nearshore zones and coastal resources. The Onshore Transmission Cable will also be installed via HDD under the Intracoastal Waterway (ICW) to avoid impacts to coastal resources; HDD and trenchless methods will also be used elsewhere onshore, where appropriate, to minimize impacts to resource areas. • Onshore Facilities are primarily sited within previously disturbed and developed areas (e.g., roadways, ROWs, developed industrial/commercial areas) to the extent feasible, to minimize impacts to undisturbed coastal and terrestrial habitat. • A SWPPP, including erosion and sedimentation control BMPs and revegetation measures, will be implemented to minimize potential water quality impacts from construction and O&M of the Onshore Facilities. • Accidental spill or release of oils or other hazardous materials will be managed offshore through an ERP/OSRP and onshore through an SPCC Plan. • Where HDD is utilized, an Inadvertent Return Plan will be prepared and implemented to minimize the potential risks associated with the release of drilling fluids. • Time-of-year restrictions for certain work activities (e.g., HDD conduit stringing and tree removal) will be employed to the extent feasible to avoid or minimize direct impacts to terrestrial habitat and RTE species during construction of the Landfall and Onshore Facilities. If work is anticipated to occur outside of these time-of-year restriction periods, Sunrise Wind will work with state and federal agencies to develop construction monitoring and impact minimization plans or mitigation plans, as appropriate. • Where appropriate, temporary erosion controls such as swales and erosion control socks will be installed and will be maintained until the site is restored and stabilized. • An Invasive Species Management Plan (ISMP) will be implemented to manage the spread of invasive plant species that could negatively affect native plants and coastal habitat. • Sunrise Wind will comply with applicable international (IMO MARPOL), federal (USCG), and state regulations and standards for treatment and disposal of solid and liquid wastes generated during all phases of the Project.
Benthic and Shellfish Resources	<ul style="list-style-type: none"> • Seafloor and Land Disturbance • Sediment Suspension and Deposition • Noise • Discharges and Releases • Trash and Debris 	<ul style="list-style-type: none"> • Sunrise Wind is committed to collaborative science with the commercial and recreational fishing industries prior to, during, and following construction. Fisheries monitoring studies are being planned to assess the impacts associated with the Project on economically and ecologically important fisheries resources within the SRWF and along the SRWEC. These studies will be conducted in collaboration with the local fishing industry and will build upon monitoring efforts being conducted by affiliates of Sunrise Wind at other wind farms in the region. • The SRWF and SRWEC will be sited to avoid and minimize impacts to sensitive habitats (e.g., hard bottom habitats) to the extent practicable. • To the extent feasible, the SRWEC and IAC will typically target a burial depth of 3 to 7 ft (1 to 2 m). The target burial depth will be determined based on an assessment of seabed conditions, seabed mobility, the risk of interaction with external hazards such as fishing gear and vessel anchors, and a site-specific Cable Burial Risk Assessment. • The SRWEC Landfall will be installed via horizontal directional drilling (HDD) to avoid impacts to the nearshore zones and benthic resources. The Onshore Transmission Cable will also be installed via HDD under the Intracoastal Waterway (ICW) to avoid impacts to benthic resources; HDD and trenchless methods will also be used elsewhere onshore, where appropriate, to minimize impacts to resource areas. • To the extent feasible, installation of the IAC and SRWEC will be buried using equipment such as mechanical plow, jet plow, and/or mechanical cutter. These equipment options would result in less habitat modification than dredging options. The feasibility of cable burial equipment will be determined based on an assessment of seabed conditions and the Cable Burial Risk Assessment. • DP vessels will be used for installation of the IAC and SRWEC to the extent practicable. DP vessels minimize seafloor impacts, as compared to use of a vessel relying on multiple anchors. • A plan for vessels will be developed prior to construction to identify no-anchorage areas to avoid documented sensitive resources. • Sunrise Wind will require all construction and O&M vessels to comply with applicable International Convention for the Prevention of Pollution from Ships (IMO MARPOL), federal (USCG and EPA), and state regulations and standards for the management, treatment, discharge, and disposal of onboard solid and liquid wastes and the prevention and control of spills and discharges. Accidental spill or release of oils or other hazardous materials will be managed offshore through an ERP/OSRP and onshore through an SPCC Plan.
Finfish and Essential Fish Habitat (EFH)	<ul style="list-style-type: none"> • Seafloor and Land Disturbance • Sediment Suspension and Deposition • Noise • Electric and Magnetic Fields • Discharges and Releases • Trash and Debris • Traffic • Lighting and Marking 	<ul style="list-style-type: none"> • Sunrise Wind is committed to collaborative science with the commercial and recreational fishing industries prior to, during, and following construction. Fisheries monitoring studies are being planned to assess the impacts associated with the Project on economically and ecologically important fisheries resources within the SRWF and along the SRWEC. These studies will be conducted in collaboration with the local fishing industry and will build upon monitoring efforts being conducted by affiliates of Sunrise Wind at other wind farms in the region. • To the extent feasible, installation of the IAC and SRWEC will be buried using equipment such as mechanical plow, jet plow, and/or mechanical cutter. These equipment options would result in less habitat modification than dredging options. The feasibility of cable burial equipment will be determined based on an assessment of seabed conditions and the Cable Burial Risk Assessment. • To the extent feasible, the SRWEC and IAC will typically target a burial depth of 3 to 7 ft (1 to 2 m). The target burial depth will be determined based on an assessment of seabed conditions, seabed mobility, the risk of interaction with external hazards such as fishing gear and vessel anchors, and a site-specific Cable Burial Risk Assessment. • The SRWEC Landfall will be installed via horizontal directional drilling (HDD) to avoid impacts to the nearshore zones and finfish resources. The Onshore Transmission Cable will also be installed via HDD under the Intracoastal Waterway (ICW) to avoid impacts to coastal resources; HDD and trenchless methods will also be used elsewhere onshore, where appropriate, to minimize impacts to resource areas. • Construction and operational lighting will be limited to the minimum necessary to ensure safety and compliance with applicable regulations. Limiting lighting to that which is required for safety and compliance with applicable regulations is expected to minimize impacts on essential fish habitat. • DP vessels will be used for installation of the IAC and SRWEC to the extent practicable. Use of DP vessels will minimize impacts to the seabed, compared to use of a vessel relying on multiple anchors. A plan for vessels will be developed prior to construction to identify no-anchorage areas to avoid documented sensitive resources. • Time-of-year in-water restrictions will be employed to the extent feasible to avoid or minimize direct impacts to species of concern, such as Atlantic sturgeon or winter flounder, during construction. If work is anticipated to occur outside of these time-of-year restriction periods, Sunrise Wind will work with state and federal agencies to develop construction monitoring and impact minimization plans or mitigation plans, as appropriate. • Accidental spill or release of oils or other hazardous materials will be managed offshore through an ERP/OSRP and onshore through an SPCC Plan. • Sunrise Wind will require all construction and O&M vessels to comply with applicable International Convention for the Prevention of Pollution from Ships (IMO MARPOL), federal (USCG and EPA), and state regulations and standards for the management, treatment, discharge, and disposal of onboard solid and liquid wastes and the prevention and control of spills and discharges.

Resource	IPF Associated with Project	Environmental Protection Measures
Marine Mammals	<ul style="list-style-type: none"> • Seafloor and Land Disturbance • Sediment Suspension and Deposition • Noise • Electric and Magnetic Fields • Discharges and Releases • Trash and Debris • Traffic • Air Emissions • Visible Infrastructure • Lighting and Marking 	<ul style="list-style-type: none"> • Sunrise Wind will comply with the current National Oceanic and Atmospheric Administration (NOAA) Fisheries speed restrictions at the time of Project activities. • Sunrise Wind will require operational automatic identification system (AIS) on all vessels associated with the construction, O&M, and decommissioning of the Project, pursuant to USCG and AIS carriage requirements. AIS will be used to monitor the number of vessels and traffic patterns for analysis and compliance with vessel speed requirements. • Sunrise Wind will adhere to vessel strike avoidance measures as required by BOEM and NOAA Fisheries. • To the extent feasible, the SRWEC and IAC will typically target a burial depth of 3 to 7 ft (1 to 2 m). The target burial depth will be determined based on an assessment of seabed conditions, seabed mobility, the risk of interaction with external hazards such as fishing gear and vessel anchors, and a site-specific Cable Burial Risk Assessment. • For all munitions and explosives of concern/unexploded ordnance (MEC/UXO) clearance methods, safety measures such as the use of guard vessels, enforcement of safety zones, and others will be identified in consultation with a MEC/UXO specialist and the appropriate agencies and implemented as appropriate. Residual risk management actions will be implemented, including developing an emergency response plan, conducting MEC/UXO-specific safety briefings, and retaining an on-call MEC/UXO consultant. • Plow cables/umbilicals will be under constant tension, and in this taut condition, are not expected to represent an entanglement risk. • Sunrise Wind will require all construction and O&M vessels to comply with applicable International Convention for the Prevention of Pollution from Ships (IMO MARPOL), federal (USCG and EPA), and state regulations and standards for the management, treatment, discharge, and disposal of onboard solid and liquid wastes and the prevention and control of spills and discharges. • Sunrise Wind will provide training for personnel onboard Project vessels, including PSO monitoring and reporting procedures, to emphasize individual responsibility for marine mammal awareness and protection. • All crew supporting the Project will undergo marine debris awareness training, and such training will include use of the data and educational resources available through the NOAA Fisheries Marine Debris Program. • Sunrise Wind will advise all construction and O&M vessels to comply with USCG and EPA regulations that require operators to develop waste management plans, post informational placards, manifest trash sent to shore, and use special precautions such as covering outside trash bins to prevent accidental loss of solid materials. • Sunrise Wind completed a comprehensive underwater acoustic assessment to include modeling in support of evaluation of potential impacts due to noise generated during construction of the Project. The assessment followed NOAA Fisheries' 2018 revised <i>Technical Guidance for Assessing the Effects of Anthropogenic Sound on Marine Mammal Hearing</i> (NOAA Construction and Operations Plan Fisheries 2018a). Potential zones of influence described in this assessment will be reflected in the proposed mitigation measures in the mitigation and monitoring plan. • Sunrise Wind will continue to support external initiatives to further mitigate marine traffic impacts and currently is a supporter of the Whale Alert system. • Sunrise Wind will participate in a developer co-funded initiative to support continuation of New England Aquarium Right Whale Aerial Surveys in 2020/21. • Additionally, the Project will implement the following mitigation measures, pursuant to ongoing dialogue with BOEM and NOAA Fisheries. Each of these methods and tools has been successfully applied by Orsted, Sunrise Wind, and/or its affiliates in support of geophysical surveys and/or the construction and operation of offshore wind projects across the globe. A protected species mitigation and monitoring plan will describe these measures and will be included within the Letter of Authorization (LOA): <ul style="list-style-type: none"> – Exclusion and monitoring zones – Ramp-up/soft-start procedures – Shutdown procedures (if technically feasible) – Qualified and NOAA Fisheries-approved protected species observers (PSOs) – Noise attenuation technologies – Passive Acoustic Monitoring systems (fixed and mobile) – Reduced visibility monitoring tools/technologies (e.g., night vision, infrared and/or thermal cameras) – Adaptive vessel speed reductions – Utilization of software to share visual and acoustic detection data between platforms in real time.

CONSTRUCTION AND OPERATIONS PLAN

Resource	IPF Associated with Project	Environmental Protection Measures
Sea Turtles	<ul style="list-style-type: none"> • Seafloor and Land Disturbance • Sediment Suspension and Deposition • Noise • Electric and Magnetic Fields • Discharges and Releases • Trash and Debris • Traffic • Visible Infrastructure • Lighting and Marking 	<ul style="list-style-type: none"> • Sunrise Wind will comply with the current NOAA Fisheries speed restrictions at the time of Project activities. These measures for marine mammals will aid in minimizing impacts to sea turtles as well. • Sunrise Wind will require operational AIS on all vessels associated with the construction, operation, and decommissioning of the Project, pursuant to USCG and AIS carriage requirements. AIS will be used to monitor the number of vessels and traffic patterns for analysis and compliance with vessel speed requirements. • Sunrise Wind will adhere to vessel strike avoidance measures as required by BOEM and NOAA Fisheries. • To the extent feasible, the SRWEC and IAC will typically target a burial depth of 3 to 7 ft (1 to 2 m). The target burial depth will be determined based on an assessment of seabed conditions, seabed mobility, the risk of interaction with external hazards such as fishing gear and vessel anchors, and a site-specific Cable Burial Risk Assessment. • For all MEC/UXO clearance methods, safety measures such as the use of guard vessels, enforcement of safety zones, and others will be identified in consultation with a MEC/UXO specialist and the appropriate agencies and implemented as appropriate. Residual risk management actions will be implemented, including developing an emergency response plan, conducting MEC/UXO-specific safety briefings, and retaining an on-call MEC/UXO consultant. • Plow cables/umbilicals will be under constant tension, and in this taut condition, are not expected to represent an entanglement risk. • Sunrise Wind will require all construction and O&M vessels to comply with applicable International Convention for the Prevention of Pollution from Ships (IMO MARPOL), federal (USCG and EPA), and state regulations and standards for the management, treatment, discharge, and disposal of onboard solid and liquid wastes and the prevention and control of spills and discharges. • Sunrise Wind will provide training for personnel onboard Project vessels, including PSO monitoring and reporting procedures, to emphasize individual responsibility for sea turtle awareness and protection. • All crew supporting the Project will undergo marine debris awareness training, and such training will include use of the data and educational resources available through the NOAA Fisheries Marine Debris Program. • Sunrise Wind will advise all construction and O&M vessels to comply with USCG and EPA regulations that require operators to develop waste management plans, post informational placards, manifest trash sent to shore, and use special precautions such as covering outside trash bins to prevent accidental loss of solid materials. • Sunrise Wind completed a comprehensive underwater acoustic assessment to include modeling in support of evaluation of potential impacts due to noise generated during construction of the Project. The assessment followed NOAA Fisheries' Greater Atlantic Regional Fisheries Office tool for assessing the potential effects to ESA-listed fish and sea turtles exposed to elevated levels of underwater sound from pile driving. Potential zones of influence described in this assessment will be reflected in the proposed mitigation measures in the mitigation and monitoring plan. • Additionally, the Project will implement the following mitigation measures, pursuant to ongoing dialogue with BOEM and NOAA Fisheries. Each of these methods and tools has been successfully applied by Orsted, Sunrise Wind, and/or its affiliates in support of geophysical surveys and/or the construction and operation of offshore wind projects across the globe. A protected species mitigation and monitoring plan will describe these measures and will be included within the LOA; these measures will also aid in minimizing impacts to sea turtles: <ul style="list-style-type: none"> – Exclusion and monitoring zones – Ramp-up/soft-start procedures – Shutdown procedures (if technically feasible) – Qualified and NOAA Fisheries-approved protected species observers (PSOs) – Noise attenuation technologies – Passive Acoustic Monitoring systems (fixed and mobile) – Reduced visibility monitoring tools/technologies (e.g., night vision, infrared and/or thermal cameras) – Adaptive vessel speed reductions – Utilization of software to share visual and acoustic detection data between platforms in real time.

Resource	IPF Associated with Project	Environmental Protection Measures
Avian Species	<ul style="list-style-type: none"> • Seafloor and Land Disturbance • Sediment Suspension and Deposition • Noise • Discharges and Releases • Trash and Debris • Traffic • Visible Infrastructure • Lighting and Marking 	<ul style="list-style-type: none"> • Sunrise Wind is committed to an indicative layout scenario with WTGs and the OCS–DC sited in a uniform east-west/north-south grid with 1.15 by 1.15-mi (1 by 1-nm; 1.85 by 1.85-km) spacing that aligns with other proposed adjacent offshore wind projects in the RI-MA WEA and MA WEA. This wide spacing of WTGs may reduce risk of barrier effects and/or displacement, and may allow avian species to avoid individual WTGs and minimize risk of potential collision. The WTGs will have an air gap from MSL to minimum blade swept height of 98 to 180 ft (30 to 55 m); birds crossing the area within this height range would not be at risk of collision with spinning blades. • The distance of the SRWF offshore (greater than 15 miles ([13 nm, 24.1 km]) avoids coastal areas, which are known to concentrate birds, particularly shorebirds and sea ducks. • Sunrise Wind will take measures to reduce perching opportunities at operating turbines, if appropriate based on further consultations with state and federal agencies. • Sunrise Wind will document any dead (or injured) birds found incidentally on vessels and structures during construction, O&M, and decommissioning and provide an annual report to BOEM and USFWS. • Construction and operational lighting will be limited to the minimum necessary to ensure safety and compliance with applicable regulations. Limiting lighting to that which is required for safety and compliance with applicable regulations is expected to minimize impacts on avian species. • Sunrise Wind will use ADLS or related means (e.g., dimming or shielding) to limit visual impact, pursuant to approval by the FAA and BOEM, commercial and technical feasibility at the time of FDR/FIR approval, and dialogue with stakeholders. In addition to limiting visual impact, reducing lighting will also reduce the potential for impacts to avian species. • Accidental spill or release of oils or other hazardous materials will be managed offshore through an ERP/OSRP and onshore through an SPCC Plan. • Time-of-year restrictions for certain work activities such as HDD conduit stringing will be employed to the extent feasible to avoid or minimize direct impacts to RTE avian species during construction of the Landfall. Time-of-year restrictions for tree removal at the Onshore Facilities to avoid impacts to northern long-eared bats would also benefit breeding birds. If work is anticipated to occur outside of these time-of-year restriction periods, Sunrise Wind will work with state and federal agencies to develop construction monitoring and impact minimization plans or mitigation plans, as appropriate. • Onshore Facilities are primarily sited within previously disturbed and developed areas (e.g., roadways, ROWs, developed industrial/commercial areas) to the extent feasible, thereby minimizing impacts to undisturbed avian habitat. • An ISMP will be implemented to manage the spread of invasive plant species that could negatively impact native plants and avian habitat. • The Onshore Transmission Cable and Onshore Interconnection Cable will not include any overhead utility poles, thus minimizing potential impacts to birds associated with collision with overhead lines. • Sunrise Wind is developing an avian post-construction monitoring plan for the Project that will summarize the approach to monitoring; describe overarching monitoring goals and objectives; identify the key avian species, priority questions, and data gaps unique to the region and Project Area that will be addressed through monitoring; and describe methods and time frames for data collection, analysis, and reporting. Post-construction monitoring will assess impacts of the Project with the purpose of filling select information gaps and supporting validation of the Sunrise Wind Avian Risk Assessment. Focus may be placed on improving knowledge of ESA-listed species occurrence and movements offshore, avian collision risk, species/species-group displacement, or similar topics. Where practicable, monitoring conducted by Sunrise Wind will build on and align with post-construction monitoring conducted by the other Orsted/Eversource offshore wind projects in the Northeast region. Sunrise Wind will engage with federal and state agencies and environmental groups (eNGOs) to identify appropriate monitoring options and technologies, and to facilitate acceptance of the final plan.
Bat Species	<ul style="list-style-type: none"> • Seafloor and Land Disturbance • Noise • Traffic • Visible Infrastructure • Lighting and Marking 	<ul style="list-style-type: none"> • Sunrise Wind is committed to an indicative layout scenario with WTGs and the OCS–DC sited in a uniform east-west/north-south grid with 1.15 by 1.15-mi (1 by 1-nm; 1.85 by 1.85-km) spacing that aligns with other proposed adjacent offshore wind projects in the RI-MA WEA and MA WEA. This wide spacing of WTGs may reduce risk of barrier effects and/or displacement, and may allow bats to avoid individual WTGs and minimize risk of potential collision. The WTGs will have an air gap from MSL to minimum blade swept height of 98 to 180 ft (30 to 55 m); bats crossing the area within this height range would not be at risk of collision with spinning blades. • The distance of the SRWF offshore (greater than 15 miles [13 nm, 24.1 km]) avoids coastal and nearshore areas where bats typically occur. • Construction and operational lighting will be limited to the minimum necessary to ensure safety and compliance with applicable regulations. Limiting lighting to that which is required for safety and compliance with applicable regulations is expected to minimize impacts on bats. • Sunrise Wind will use ADLS or related means (e.g., dimming or shielding) to limit visual impact, pursuant to approval by the FAA and BOEM, commercial and technical feasibility at the time of FDR/FIR approval, and dialogue with stakeholders. In addition to limiting visual impact, reducing lighting will also reduce the potential for impacts to bats. • Onshore Facilities are primarily sited within previously disturbed and developed areas (e.g., roadways, ROWs, developed industrial/commercial areas) to the extent feasible, thereby minimizing impacts to undisturbed bat habitat. • An ISMP will be implemented to manage the spread of invasive plant species that could negatively impact native plants and bat habitat. • Sunrise Wind will document any dead (or injured) bats found incidentally on vessels and structures during construction, O&M, and decommissioning and provide an annual report to BOEM and USFWS. • Time-of-year restrictions for certain work activities such as tree removal will be employed to the extent feasible to avoid or minimize direct impacts to northern long-eared bats during construction of the Onshore Facilities. If work is anticipated to occur outside of this period, Sunrise Wind will work with state and federal agencies to develop construction monitoring and impact minimization plans or mitigation plans, as appropriate. • The Onshore Transmission Cable and Onshore Interconnection Cable will not include any overhead utility poles, thus minimizing potential impacts to bats associated with collision with overhead lines.

CONSTRUCTION AND OPERATIONS PLAN

Resource	IPF Associated with Project	Environmental Protection Measures
Visual Resources	<ul style="list-style-type: none"> Traffic Visible Infrastructure Lighting and Marking 	<ul style="list-style-type: none"> WTGs will have uniform design, height, and rotor diameter. The WTGs will be painted no lighter than Pure White (RAL 9010) and no darker than Light Grey (RAL 7035) as recommended by BOEM and the FAA. Turbines of this color white generally blend well with the sky at the horizon and eliminate the need for daytime warning lights or red paint marking of the blade tips. The WTGs and OCS-DC will be lit and marked in accordance with BOEM and USCG requirements for aviation and navigation obstruction lighting, respectively. The WTGs will be lit and marked in accordance with FAA Advisory Circular 70/7460-1L (2018), as recommended by BOEM's <i>Guidelines for Lighting and Marking of Structures Supporting Renewable Energy Development</i> (BOEM 2021). Sunrise Wind will use ADLS or related means (e.g., dimming or shielding) to limit visual impact, pursuant to approval by the FAA and BOEM, commercial and technical feasibility at the time of FDR/FIR approval, and dialogue with stakeholders. The construction of the Landfall and ICW HDD is expected to occur outside the summer tourist season, which is generally between Memorial Day and Labor Day. The construction schedule for the remaining Onshore Facilities will be designed to minimize impacts to the local communities to the extent feasible. The Onshore Transmission Cable and Onshore Interconnection Cable will not include any overhead utility poles, thus minimizing potential impacts to adjacent properties. The OnCS-DC is sited near an existing substation on a parcel zoned for commercial and industrial/utility use. Screening will be implemented at the OnCS-DC to the extent feasible, to reduce potential visibility and noise.
Marine Archaeological Resources (MARs)	<ul style="list-style-type: none"> Seafloor and Land Disturbance Sediment Suspension and Deposition 	<ul style="list-style-type: none"> The SRWF and SRWEC will be sited to avoid or minimize impacts to potential MARs, including shipwrecks and paleolandforms, to the extent practicable, with continued oversight by a Qualified Marine Archaeologist. Native American tribes were involved, and will continue to be involved, in marine survey protocol design, execution of the surveys, and interpretation of the results. A plan for vessels will be developed prior to construction to identify no-anchorage areas to avoid documented sensitive resources. Avoidance areas surrounding identified MARs will reduce the chances of accidental disturbance. The size of these areas will be determined individually based on characterization of the site and delineation of the site's horizontal and vertical boundaries. An Unanticipated Discovery Plan will be implemented that will include stop-work and notification procedures to be followed if potentially significant MARs are encountered or inadvertently disturbed during construction.
Terrestrial Archaeological Resources	<ul style="list-style-type: none"> Seafloor and Land Disturbance 	<ul style="list-style-type: none"> Onshore Facilities are primarily sited within previously disturbed and developed areas (e.g., roadways, ROWs, developed industrial/commercial areas) to the extent feasible, to minimize impacts to potential archaeological resources. Onshore Facilities have been sited, using guidance from cultural resources surveys, to avoid or minimize impacts to potential terrestrial archeological resources. Native American tribes were involved, and will continue to be involved, in terrestrial survey protocol design, execution of the surveys, and interpretation of the results. An Unanticipated Discovery Plan will be implemented that will include stop-work and notification procedures to be followed if a cultural resource is encountered during installation.
Above-Ground Historic Properties	<ul style="list-style-type: none"> Noise Traffic Visible Infrastructure Lighting and Marking 	<ul style="list-style-type: none"> WTGs will have uniform design, height, and rotor diameter. The WTGs will be painted no lighter than Pure White (RAL 9010) and no darker than Light Grey (RAL 7035) as recommended by BOEM and the FAA. Turbines of this color white generally blend well with the sky at the horizon and eliminate the need for daytime warning lights or red paint marking of the blade tips. The WTGs and the OCS-DC will be lit and marked in accordance with BOEM and USCG requirements for aviation and navigation obstruction lighting, respectively. Sunrise Wind will use ADLS or related means (e.g., dimming or shielding) to limit visual impact, pursuant to approval by the FAA and BOEM, commercial and technical feasibility at the time of FDR/FIR approval, and dialogue with stakeholders. The Onshore Transmission Cable and Onshore Interconnection Cable will not include any overhead utility poles, thus minimizing potential impacts to adjacent properties. The OnCS-DC is sited near an existing substation on a parcel zoned for commercial and industrial/utility use. Screening will be implemented at the OnCS-DC to the extent feasible, to reduce potential visibility and noise.
Employment, Economics, and Demographics	<ul style="list-style-type: none"> Visible Infrastructure Traffic 	<ul style="list-style-type: none"> Where feasible, local workers will be hired to meet labor needs for Project construction, O&M, and decommissioning. The construction of the Landfall and ICW HDD is expected to occur outside the summer tourist season, which is generally between Memorial Day and Labor Day. The construction schedule for the remaining Onshore Facilities will be designed to minimize impacts to the local communities to the extent feasible. The Onshore Transmission Cable and Onshore Interconnection Cable will not include any overhead utility poles, thus minimizing potential impacts to adjacent properties. Screening will be implemented at the OnCS-DC to the extent feasible, to reduce potential visibility and noise. Sunrise Wind will coordinate with local authorities and develop a Maintenance and Protection of Traffic (MPT) plan as part of the Project's Environmental Management and Construction Plan (EM&CP) to minimize potential traffic impacts during construction. Sunrise Wind will use ADLS or related means (e.g., dimming or shielding) to limit visual impact, pursuant to approval by the FAA and BOEM, commercial and technical feasibility at the time of FDR/FIR approval, and dialogue with stakeholders.

CONSTRUCTION AND OPERATIONS PLAN

Resource	IPF Associated with Project	Environmental Protection Measures
Public Services	<ul style="list-style-type: none"> Traffic 	<ul style="list-style-type: none"> The construction of the Landfall and ICW HDD is expected to occur outside the summer tourist season, which is generally between Memorial Day and Labor Day. The construction schedule for the remaining Onshore Facilities will be designed to minimize impacts to the local communities to the extent feasible. Sunrise Wind will coordinate with local authorities and develop an MPT plan as part of the Project's EM&CP to minimize potential traffic impacts during construction. A comprehensive communication plan will be implemented during offshore construction to inform all mariners, including commercial and recreational fishing vessels, and recreational boaters, of construction activities and Project-related vessel movements. Communication will be facilitated through a Project website, public notices to mariners and vessel float plans, and a Fisheries Liaison. Sunrise Wind will submit information to the USCG to issue Local Notice to Mariners during offshore installation activities.
Recreation & Tourism	<ul style="list-style-type: none"> Traffic Visible Infrastructure Lighting and Marking 	<ul style="list-style-type: none"> The construction of the Landfall and ICW HDD is expected to occur outside the summer tourist season, which is generally between Memorial Day and Labor Day. The construction schedule for the remaining Onshore Facilities will be designed to minimize impacts to the local communities to the extent feasible. Sunrise Wind will coordinate with local authorities and develop an MPT plan as part of the Project's EM&CP to minimize potential traffic impacts during construction. A comprehensive communication plan will be implemented during offshore construction to inform all mariners, including commercial and recreational fishing vessels, and recreational boaters, of construction activities and Project-related vessel movements. Communication will be facilitated through a Project website, public notices to mariners and vessel float plans, and a Fisheries Liaison. Sunrise Wind will submit information to the USCG to issue Local Notice to Mariners during offshore installation activities. The communication plan will include outreach to stakeholders in the offshore recreational and tourism industry to minimize impacts to recreational events (e.g., sailboat races).
Commercial and Recreational Fishing	<ul style="list-style-type: none"> Seafloor and Land Disturbance Sediment Suspension and Deposition Noise Electric and Magnetic Fields Discharges and Releases Trash and Debris Traffic Visible Infrastructure Lighting and Marking 	<ul style="list-style-type: none"> Sunrise Wind is committed to an indicative layout scenario with WTGs and the OCS-DC sited in a uniform east-west/north-south grid with 1.15 by 1.15-mi (1 by 1-nm; 1.85 by 1.85-km) spacing that aligns with other proposed adjacent offshore wind projects in the RI-MA WEA and MA WEA. This layout has been confirmed through expert analysis and the USCG (USCG 2020) to allow for safe navigation without the need for additional designated transit lanes. This layout will also provide a uniform, wide spacing among structures to facilitate search and rescue operations and is consistent with study recommendations in the USCG Massachusetts and Rhode Island Port Access Route Study (USCG 2020). Sunrise Wind is committed to collaborative science with the commercial and recreational fishing industries prior to, during, and following construction. Fisheries monitoring studies are being planned to assess the impacts associated with the Project on economically and ecologically important fisheries resources within the SRWF and along the SRWEC. These studies will be conducted in collaboration with the local fishing industry and will build upon monitoring efforts being conducted by affiliates of Sunrise Wind at other wind farms in the region. Sunrise Wind aims, where feasible, to mitigate and reduce potential impacts to fishing activities, as outlined in the <i>Fisheries Communication and Outreach Plan</i> (Appendix B), and the <i>Fisheries Mitigation Plan for Sunrise Wind</i> (Sunrise Wind 2019), which is available on the NYSERDA website and will be updated throughout Project development. The locations of the SRWF, SRWEC, and IAC and associated cable protections will be provided to NOAA's Office of Coast Survey after installation is completed so that they may be marked on nautical charts. To the extent feasible, installation of the SRWEC and IAC will occur using methods such as mechanical plow, jet plow, or mechanical cutter. To the extent feasible, the SRWEC and IAC will typically target a burial depth of 3 to 7 ft (1 to 2 m). The target burial depth will be determined based on an assessment of seabed conditions, seabed mobility, the risk of interaction with external hazards such as fishing gear and vessel anchors, and a site-specific Cable Burial Risk Assessment. The cables include various protective armoring and sheathing to protect the cable from external damage and keep it watertight. Cable protection measures will be employed where cable burial depth is not adequate. As appropriate and feasible, BMPs will be implemented to minimize impacts on fisheries, as described in BOEM's <i>Guidelines for Providing Information on Fisheries for Renewable Energy Development on the Atlantic Outer Continental Shelf Pursuant to 30 CFR Part 585</i> (BOEM 2019). The WTGs will be lit and marked in accordance with FAA Advisory Circular 70/7460-1L (2018), as recommended by BOEM's <i>Guidelines for Lighting and Marking of Structures Supporting Renewable Energy Development</i> (BOEM 2021). The WTGs and the OCS-DC will be lit and marked in accordance with BOEM and USCG requirements for aviation and navigation obstruction lighting, respectively. Navigation lights, markings, sound signals, and other aids to navigation (ATON)(including AIS on select WTGs) will be installed and maintained as prescribed within the Private Aids to Navigation (PATON) permit issued by the USCG for each WTG and the OCS-DC. Sunrise Wind will require all construction and O&M vessels to comply with applicable International Convention for the Prevention of Pollution from Ships (IMO MARPOL), federal (USCG and EPA), and state regulations and standards for the management, treatment, discharge, and disposal of onboard solid and liquid wastes and the prevention and control of spills and discharges. Accidental spill or release of oils or other hazardous materials will be managed offshore through an ERP/OSRP and onshore through an SPCC Plan. Project construction, O&M, and decommissioning activities will be coordinated with appropriate contacts at USCG and DoD command headquarters. A comprehensive communication plan will be implemented during offshore construction to inform all mariners, including commercial and recreational fishing vessels, and recreational boaters, of construction activities and Project-related vessel movements. Communication will be facilitated through a Project website, public notices to mariners and vessel float plans, and a Fisheries Liaison. Sunrise Wind will submit information to the USCG to issue Local Notice to Mariners during offshore installation activities.

CONSTRUCTION AND OPERATIONS PLAN

Resource	IPF Associated with Project	Environmental Protection Measures
Other Marine Uses and Coastal Land Use	<ul style="list-style-type: none"> • Seafloor and Land Disturbance • Traffic • Visible Infrastructure • Lighting and Marking 	<ul style="list-style-type: none"> • Sunrise Wind will minimize conflicts with other marine uses, through development and implementation of a MEC/UXO risk assessment strategy, coordination with USCG and DoD (including Public Notices to Mariners), coordination with existing telecommunications cable owners, and coordination with BOEM and potential future lease owners if a lease area is identified at a future time in the area where the SRWEC is sited. • Sunrise Wind will consult with the USCG, US Navy, Naval Undersea Warfare Center (NUWC), the Northeast Marine Pilots Association, and regional ferry service operators to avoid or reduce use conflicts. • Sunrise Wind has implemented, or will implement, a number of measures to minimize adverse effects on existing cables, such as dropping four WTG positions; minimizing the number of IAC and SRWEC crossings, and crossing perpendicular where feasible; designing the Landfall HDD to avoid existing cables; coordinating with telecommunications cable owners to develop cable protection design, crossing, and proximity agreements; and following International Cable Protection Committee (ICPC) recommendations during construction and O&M. • Navigation lights, markings, sound signals, and other ATON, including AIS on select WTGs, will be installed and maintained as prescribed within the PATON permit issued by the USGC for each WTG and the OCS-DC. • The locations of the SRWF, SRWEC, IAC, and associated cable protections will be provided to NOAA's Office of Coast Survey after installation is completed so that they may be marked on nautical charts. • Onshore Facilities are primarily sited within previously disturbed and developed areas (e.g., roadways, ROWs, developed industrial/commercial areas) to the extent feasible, to minimize impacts to undisturbed coastal land uses. • The construction of the Landfall and ICW HDD is expected to occur outside the summer tourist season, which is generally between Memorial Day and Labor Day. The construction schedule for the remaining Onshore Facilities will be designed to minimize impacts to the local communities to the extent feasible. • Sunrise Wind will coordinate with local authorities and develop an MPT plan as part of the Project's EM&CP to minimize potential traffic impacts during construction.
Environmental Justice	<ul style="list-style-type: none"> • Seafloor and Land Disturbance • Noise • Traffic • Visible Infrastructure • Lighting and Marking 	<ul style="list-style-type: none"> • The use of wind to generate electricity will have a beneficial impact on air emissions in Suffolk County, as it reduces the need for electricity generation from traditional fossil fuel power plants on Long Island that produce greenhouse gas emissions. • Where feasible, local workers will be hired to meet labor needs for Project construction, O&M, and decommissioning. • The construction of the Landfall and ICW HDD is expected to occur outside the summer tourist season, which is generally between Memorial Day and Labor Day. The construction schedule for the remaining Onshore Facilities will be designed to minimize impacts to the local communities to the extent feasible. • Sunrise Wind will coordinate with local authorities and develop an MPT plan as part of the Project's EM&CP to minimize potential traffic impacts during construction. • Onshore activities within potential Environmental Justice areas are limited to work within roadways/ROWs such that any potential adverse effects from construction/noise would be short-term and temporary. • WTGs will be aligned and spaced consistently with other offshore wind facilities in the RI/MA WEA, reducing the potential for visual clutter. • WTGs will be painted to minimize visual contrast under common and prevailing atmospheric conditions. • Sunrise Wind is committed to avoiding impacts to submerged cultural resources wherever feasible and practicable and will continue to assess means of minimizing physical impacts to resources that cannot be avoided. • Sunrise Wind will continue to engage with Native American communities to identify other measures that feasibly and appropriately protect culturally sensitive marine species and respectfully incorporate traditional knowledge and practices in such measures.

Resource	IPF Associated with Project	Environmental Protection Measures
Marine Transportation and Navigation	<ul style="list-style-type: none"> Traffic Visible Infrastructure Lighting and Marking 	<ul style="list-style-type: none"> Sunrise Wind is committed to an indicative layout scenario with WTGs and the OCS-DC sited in a uniform east-west/north-south grid with 1.15 by 1.15-mi (1 by 1-nm; 1.85 by 1.85-km) spacing that aligns with other proposed adjacent offshore wind projects in the RI-MA WEA and MA WEA. This layout has been confirmed through expert analysis and the USCG (USCG 2020) to allow for safe navigation without the need for additional designated transit lanes. This layout will also provide a uniform, wide spacing among structures to facilitate search and rescue operations and is consistent with study recommendations in the USCG Massachusetts and Rhode Island Port Access Route Study (USCG 2020). Navigation lights, markings, sound signals, and other ATON (including AIS on select WTGs) will be installed and maintained as prescribed within the PATON permit issued by the USGC for each WTG and the OCS-DC. A notional lighting plan is included within Appendix X based on existing USCG regulations and policy and standards promulgated by the International Association of Marine Aids to Navigation and Lighthouse Authorities in Recommendation O-139, The Marking of Man-Made Offshore Structures (IALA 2013). The USCG has endorsed those standards. The WTGs and the OCS-DC will be lit and marked in accordance with BOEM and USCG requirements for aviation and navigation obstruction lighting, respectively. Sunrise Wind will use ADLS or related means (e.g., dimming or shielding) to limit visual impact, pursuant to approval by the FAA and BOEM, commercial and technical feasibility at the time of FDR/FIR approval, and dialogue with stakeholders. The WTGs will be lit and marked in accordance with FAA Advisory Circular 70/7460-1L (2018), as recommended by BOEM's <i>Guidelines for Lighting and Marking of Structures Supporting Renewable Energy Development</i> (BOEM 2021). Sunrise Wind will request, and it is expected that the USCG will establish, temporary safety zones around all marine construction activities. To reduce the likelihood of an allision or collision during construction, Project safety vessel(s) will be on scene to advise mariners of construction activity. Mariner Radio-Activated Sound Signals (MRASS) are VHF-based and are expected to be deployed in the SRWF, similar to the deployment at Block Island Wind Farm. To the extent feasible, the SRWEC and IAC will typically target a burial depth of 3 to 7 ft (1 to 2 m). The target burial depth will be determined based on an assessment of seabed conditions, seabed mobility, the risk of interaction with external hazards such as fishing gear and vessel anchors, and a site-specific Cable Burial Risk Assessment. The cables include various protective armoring and sheathing to protect the cable from external damage and keep it watertight. Cable protection measures will be employed where cable burial depth is not adequate. Vessel operators are expected to follow the International Regulations for Preventing Collisions at Sea 1972 (COLREGs) Rule 5 that states "at all times maintain a proper lookout by sight and hearing as well as by all available means appropriate in the prevailing circumstances and conditions so as to make a full appraisal of the situation and risk of collision." Sunrise Wind will require operational AIS on all vessels associated with construction, O&M, and decommissioning of the Project, pursuant to USCG and AIS carriage requirements. AIS will be used to monitor the number of vessels and traffic patterns for analysis and compliance with vessel speed requirements. The WTGs and the OCS-DC will have a marked air gap to aid in the avoidance of an allision incident. Emergency procedures will be developed and reviewed with relevant agencies, including the USCG, to ensure that response plans are adequate and properly resourced. A Project construction guideline will define a window related to wind, sea state, and other constraints under which construction activities will start/continue or will stop/be discontinued. Conditions and forecasts will be monitored to enable proactive planning and early warning of future unsafe conditions. A 24-hr operational monitoring center is planned to verify safe conditions are being maintained and will have the ability to remotely operate and shut down WTGs if required. During construction and O&M, notices to mariners will be published on, and broadcasted through, regular radio communications, online information will be available for mariners, and notices to mariners from the USCG will occur. Frequent updates on offshore activities to fishing operators will be provided via online updates, twice-daily updates on VHF channels, and through Fisheries Liaisons and local fisheries representatives based in regional ports. Information on the exact locations of newly installed Project components, including structures, cable, and cable protection, will be provided to NOAA to include on navigation charts to reduce any potential impact to marine navigation. The WTGs themselves may also serve as an information navigation aid for mariners, particularly at night because they will be lit and marked. A comprehensive communication plan will be implemented during offshore construction to inform all mariners, including commercial and recreational fishing vessels, and recreational boaters, of construction activities and Project-related vessel movements. Communication will be facilitated through a Project website, public notices to mariners and vessel float plans, and a Fisheries Liaison. Sunrise Wind will submit information to the USCG to issue Local Notice to Mariners during offshore installation activities.
Land Transportation and Navigation	<ul style="list-style-type: none"> Traffic 	<ul style="list-style-type: none"> To minimize impacts to local traffic, several trenchless crossings are planned along the route for the Onshore Transmission Cable, including at the Long Island Rail Road (LIRR). The construction of the Landfall and ICW HDD is expected to occur outside the summer tourist season, which is generally between Memorial Day and Labor Day. The construction schedule for the remaining Onshore Facilities will be designed to minimize impacts to the local communities to the extent feasible. All construction-related impacts to roadways and parking lots will be restored to pre-construction conditions in accordance with <i>NYS DOT Standard Specifications for Construction and Materials</i> and in coordination with local entities. Locations used for HDD work areas and temporary laydown yards will be restored to pre-existing conditions in accordance with landowner requests and permit requirements. Sunrise Wind will coordinate with local authorities and develop an MPT plan as part of the Project's EM&CP to minimize potential traffic impacts during construction. To allow for traffic to move safely, traffic control measures, such as signage and traffic flaggers, will be used wherever necessary. Traffic control measures to address traffic flow in and around construction areas will be developed as part of the MPT plans. Proper traffic control measures will be utilized to ensure the movement of traffic and to mitigate impacts on bus route schedules. Access to bus stops will also be maintained or temporarily relocated during construction, thereby minimizing impacts to bus stops and bus stop access. Because the Onshore Transmission Cable and Onshore Interconnection Cable will be installed entirely underground, it is not anticipated that operation of the Project will have an impact on local traffic during O&M. The Onshore Transmission Cable and Onshore Interconnection Cable will require very little maintenance, if any.

CONSTRUCTION AND OPERATIONS PLAN

Resource	IPF Associated with Project	Environmental Protection Measures
Air Transportation and Navigation	<ul style="list-style-type: none"> Visible Infrastructure Lighting and Marking 	<ul style="list-style-type: none"> Sunrise Wind is committed to an indicative layout scenario with WTGs and the OCS–DC sited in a uniform east-west/north-south grid with 1.15 by 1.15-mi (1 by 1-nm; 1.85 by 1.85-km) spacing that aligns with other proposed adjacent offshore wind projects in the RI-MA WEA and MA WEA. This layout has been confirmed through expert analysis and the USCG (USCG 2020) to allow for safe navigation without the need for additional designated transit lanes. This layout will also provide a uniform, wide spacing among structures to facilitate search and rescue operations and is consistent with study recommendations in the USCG Massachusetts and Rhode Island Port Access Route Study (USCG 2020). The WTGs and the OCS–DC will be lit and marked in accordance with BOEM and USCG requirements for aviation and navigation obstruction lighting, respectively. The WTGs will be lit and marked in accordance with FAA Advisory Circular 70/7460-1L (2018), as recommended by BOEM's <i>Guidelines for Lighting and Marking of Structures Supporting Renewable Energy Development</i> (BOEM 2021). Sunrise Wind will use ADLS or related means (e.g., dimming or shielding) to limit visual impact, pursuant to approval by the FAA and BOEM, commercial and technical feasibility at the time of FDR/FIR approval, and dialogue with stakeholders. The Onshore Transmission Cable and Onshore Interconnection Cable will not include any overhead utility poles.

Acronyms and Abbreviations

°C	degrees Celsius
°F	degrees Fahrenheit
µg/L	micrograms per liter
µT	microteslas
AADT	Annual Average Daily Traffic
ac	acre(s)
AC	alternating current
ACCSP	Atlantic Coastal Cooperative Statistics Program
ACPARS	Atlantic Coast Port Access Route Study
ACS	American Community Survey
ADCP	Acoustic Doppler Current Profiler
ADLS	Aircraft Detection Lighting System
AIF	actual intake flow
AIS	automatic identification system
ALARP	As Low As Reasonably Practicable
AMAPPS	Atlantic Marine Assessment Program for Protected Species
AMCS	Atlantic Marine Conservation Society
AMI	Area of Mutual Interest
AMSL	above mean sea level
APE	Area of Potential Effect
API	American Petroleum Institute
ASCE	American Society of Civil Engineers
ASMFC	Atlantic States Marine Fisheries Commission
ATON	aids to navigation
AWEA	American Wind Energy Association
BACT	Best Available Control Technology
BEA	Bureau of Economic Analysis
BGEPA	<i>Bald and Golden Eagle Protection Act</i>
bgs	below ground surface

CONSTRUCTION AND OPERATIONS PLAN

BLS	Basic Life Support
BMP	best management practice
BOEM	Bureau of Ocean Energy Management
BSEE	Bureau of Safety and Environmental Enforcement
CAA	<i>Clean Air Act</i>
CEA	Critical Environmental Area
CECPN	Certificate of Environmental Compatibility and Public Need
CEQ	Council on Environmental Quality
CES Order	Clean Energy Standards
CFCS	Center for Coastal Studies
CFE	controlled flow excavation
CFR	Code of Federal Regulations
CFSR	Climate Forecast System Reanalysis
CH ₄	methane
CIRP	Coastal Inlets Research Program
CLCPA	<i>Climate Leadership and Community Protection Act</i>
cm/s	centimeter(s) per second
CMECS	Coastal and Marine Ecological Classification Standard
CMR	Code of Massachusetts Regulations
CO	carbon monoxide
CO ₂	carbon dioxide
CO ₂ e	carbon dioxide equivalent
COA	Corresponding Onshore Area
COLREGs	International Regulations for Preventing Collisions at Sea
COP	Construction and Operations Plan
CR	Commercial Recreation
CRESLI	Coastal Research and Education Society of Long Island
CRIS	Cultural Resource Information System
CT DEEP	Connecticut Department of Energy and Environmental Protection
CTV	crew transfer vessel

CONSTRUCTION AND OPERATIONS PLAN

CVA	Certified Verification Agent
CWA	<i>Clean Water Act</i>
CWIS	cooling water intake system
cy	cubic yard(s)
CZMA	<i>Coastal Zone Management Act</i>
CZMP	Coastal Zone Management Program
dB	decibel
dBA	decibels on the A-weighted scale
DC	direct current
DDT	dichlorodiphenyltrichloroethanes
DFE	design flood elevation
DIF	design intake flow
DO	dissolved oxygen
DoD	[United States] Department of Defense
DOER	Dredging Operations and Environmental Research Program
DoT	Department of Transportation
DP	dynamic positioning
DPS	distinct population segments
DPW	Suffolk County DPW
DSM	digital surface map
DTM	digital terrain model
EC4	Executive Climate Change Coordinating Council
EFH	essential fish habitat
EIR	Environmental Impact Report
EIS	Environmental Impact Statement
EM&CP	Environmental Management and Construction Plan
EMF	electric and magnetic fields
EMS	emergency medical services
EMT	emergency medical technician
eNGOs	environmental non-governmental organizations
EO	Executive Order

CONSTRUCTION AND OPERATIONS PLAN

EPA	United States Environmental Protection Agency
EPR	ethylene propylene rubber
ERP/OSRP	emergency response plan/oil spill response plan
ESA	<i>Endangered Species Act</i>
Eversource	Eversource Investment LLC
FAA	Federal Aviation Administration
FDNY	New York City Fire Department
FDR/FIR	facility design report/fabrication and installation report
FEMA	Federal Emergency Management Agency
FHWA	Federal Highway Administration
FINS	Fire Island National Seashore
FIR	Fishing Industry Representative
FIRM	Flood Insurance Rate Maps
flidar	floating light detection and ranging
FMP	Fishery Management Plan
FPM	flashes per minute
FR	Federal Register
FR	Fisheries Representative
ft	foot/feet
FTE	full-time equivalent
F-TWG	Fisheries Technical Working Group of NYSERDA
G&G	geophysical and geotechnical
gal	gallon
GARFO	Greater Atlantic Regional Fisheries Office
GDP	gross domestic product
GEIS	Generic Environmental Impact Statement
GHG	greenhouse gas
GIS	Geographic Information Systems
GSFC	Goddard Space Flight Center
GW	gigawatt(s)

CONSTRUCTION AND OPERATIONS PLAN

GWSA	<i>Global Warming Solutions Act</i>
ha	hectare(s)
HAB	harmful algal bloom
HAB	horizontal auger boring
HAP	Hazardous Air Pollutants
HAPC	Habitat Areas of Particular Concern
HDD	horizontal directional drilling
HF	high frequency
HRG	high-resolution geophysical
HRVEA	Historic Resources Visual Effects Analysis
HURDAT2	Atlantic Hurricane Database (
HYCOM	Hybrid Coordinate Ocean Model
Hz	hertz
IAC	Inter-Array Cables
IALA	International Association of Marine Aids to Navigation and Lighthouse Authorities
IBTraCS	International Best Track Archive for Climate Stewardship
ICNIRP	International Commission for Non-Ionizing Radiation Protection
ICPC	International Cable Protection Committee
ICW	intracoastal waterway
IEC	International Electrotechnical Commission
IEEE	Institute of Electrical and Electronics Engineers
IMO	International Maritime Organization
in	inch(es)
in/s	inches per second
iPaC	Information for Planning and Consultation
IPF	impact-producing factor
ISMP	Invasive Species Management Plan
IVM	Integrated Vegetation Management
JASMINE	JASCO Animal Simulation Model Including Noise Exposure
kHz	kilohertz

CONSTRUCTION AND OPERATIONS PLAN

km	kilometer(s)
km ²	square kilometers
KOP	key observation point
kV	kilovolt(s)
kW	kilowatt(s)
L	liter(s)
LAeq	A-weighted, equivalent continuous sound level
LAER	Lowest Achievable Emission Rate
LAT	lowest astronomical tide
LF	low frequency
LGM	Last Glacial Maximum
LICAP	Long Island Commission for Aquifer Protection
lidar	light detection and ranging
LIE	Long Island Expressway
LIPA	Long Island Power Authority
LIRR	Long Island Rail Road
LNM	Local Notice to Mariners
LOA	Letter of Authorization
LSZ	Landscape Similarity Zone
m	meter(s)
M.G.L	Massachusetts General Law
m/s	meters per second
MA	Massachusetts
MA WEA	Massachusetts Wind Energy Area
MACRIS	Massachusetts Cultural Resource Information System
MACZM	Massachusetts Coastal Zone Management
MADMF	Massachusetts Department of Marine Fisheries
MAFMC	Mid-Atlantic Fishery Management Council
MAR	marine archaeological resource
MARIPAR	Massachusetts and Rhode Island Port Access Routes

CONSTRUCTION AND OPERATIONS PLAN

MARPOL	International Convention for the Prevention of Pollution from Ships
MARS	Monterey Accelerated Research System
MassCEC	Massachusetts Clean Energy Center
MassDEP	Massachusetts Department of Environmental Protection
MBES	Multibeam Echo Sounding
MBTA	<i>Migratory Bird Treaty Act</i>
MCC	Marine Coordination Center
MCS	management classification system
MDAT	Marine-life Data and Analysis Team
MDE	Maryland Department of the Environment
MDS	map-documented structures
MEC	munitions and explosives of concern
MF	mid-frequency
mG	milligauss
MHC	Massachusetts Historical Commission
MHWL	Mean High Water Line
mi	statute mile(s)
MLLW	mean lower low water
mm	millimeter(s)
MMPA	<i>Marine Mammal Protection Act</i>
mph	mile(s) per hour
MPN	most probable number
MPRSA	<i>Marine Protection, Research, and Sanctuaries Act</i>
MPT	Maintenance and Protection of Traffic
MPTP	Maintenance and Protection of Traffic Plan
MRIP	Marine Recreational Information Program
MS4	Municipal Separate Storm Sewers System
MSFCMA	<i>Magnuson-Stevens Fishery Conservation and Management Act</i>
MSIR	Marine Site Investigation Report
MSL	mean sea level

CONSTRUCTION AND OPERATIONS PLAN

mT	metric ton(s)
mV/m	millivolts/meter
MVR	Monitor Values Report
MW	megawatt
N ₂ O	nitrous oxide
NAAQS	National Ambient Air Quality Standards
NASA	National Aeronautics and Space Administration
NAVD88	North American Vertical Datum of 1988
NCA	National Coastal Assessment
NCCR	National Coastal Condition Reports
NCDC	National Climate Data Center
NCEI	National Centers for Environmental Information
NDBC	National Data Buoy Center
NEFMC	New England Fishery Management Council
NEFSC	Northeast Fisheries Science Center
NEPA	<i>National Environmental Policy Act</i>
NESC	National Electric Safety Code
NESEC	Northeast States Emergency Consortium
ng/L	nanograms per liter
NHESP	Natural Heritage and Endangered Species Program
NHL	National Historic Landmark
NHPA	<i>National Historic Preservation Act</i>
NJDEP	New Jersey Department of Environmental Protection
nm	nautical mile(s)
NMFS or 'NOAA Fisheries'	National Marine Fisheries Service
NNSR	Nonattainment New Source Review
NO ₂	nitrogen dioxide
NOA	nearest onshore area
NOAA	National Oceanic and Atmospheric Administration
NOI	notice of intent
NOS	National Ocean Service

CONSTRUCTION AND OPERATIONS PLAN

NO _x	nitrogen oxides
NPCC	Northeast Power Coordinating Council, Inc.
NPDES	National Pollutant Discharge Elimination System
NPS	National Park Service
NREL	National Renewable Energy
NRHP	National Register of Historic Places
NSR	New Source Review
NSRA	Navigation Safety Risk Assessment
NSRs	noise sensitive receptors
NTL	Notice to Lessee
NTSC	National Transportation Safety Council
NWI	National Wetlands Inventory
NWS	National Weather Service
NY	New York
NYAC	New York Archaeological Council
NYCRR	New York Codes, Rules and Regulations
NYECL	New York Environmental Conservation Law
NYISO	New York Independent System Operator
NYNHP	New York Natural Heritage Program
NYPD	New York Police Department
NYS	New York State
NYS CMP	New York State Coastal Management Program
NYSDAM	New York State Department of Agriculture and Markets
NYSDEC	New York State Department of Environmental Conservation
NYSDOH	New York State Department of Health
NYSDOS	New York State Department of State
NYSDOT	New York State Department of Transportation
NYSEP	New York State Energy Plan
NYSERDA	New York State Energy Research and Development Authority
NYSHPO	New York State Historic Preservation Office
NYSOGS	New York State Office of General Services

CONSTRUCTION AND OPERATIONS PLAN

NYSOPRHP	New York State Office of Parks, Recreation and Historic Preservation
NYSPSC	New York State Public Service Commission
O&M	operations and maintenance
O ₃	ozone
OCS	outer continental shelf
OCS Lands Act	<i>Outer Continental Shelf Lands Act</i>
OCS–DC	Offshore Converter Station
OnCS–DC	Onshore Converter Station
OPA	[New York] Offshore Planning Area
Options Paper	Offshore Wind Policy Options paper
OREC	Offshore Wind Renewable Energy Certificate
Orsted NA	Orsted North America Inc.
OSAMP	Ocean Special Area Management Plan
OSRP	Oil Spill Response Plan
OSS–AC	Offshore Substation
OW	otariid pinnipeds in water
PAPE	Preliminary Area of Potential Effect
PATON(s)	Private Aids to Navigation Permits
Pb	lead
PCA	phocid carnivores in air
PCBs	polychlorinated biphenyls
PCW	phocid carnivores in water
PDE	project design envelope
PEIS	Programmatic Environmental Impact Statement
PK	zero-to-peak sound pressure levels
PLGR	pre-lay grapnel run
PM	particulate matter
PM ₁₀	particulate matter less than 10 micrometers in aerodynamic diameter
PM _{2.5}	particulate matter less than 2.5 micrometers in aerodynamic diameter

CONSTRUCTION AND OPERATIONS PLAN

POI	point of interconnection
PPW	phocid pinnipeds in water
Project	the Sunrise Wind Farm Project
PSD	Prevention of Significant Deterioration
PSL	Public Service Law
PSO	Protected Species Observer
PTM	Particle Tracking Model
PTS	permanent threshold shift
RARMS	Risk Assessment with Risk Mitigation Strategy
RCNM	Roadway Construction Noise Model
REV	Reforming the Energy Vision
RHA	<i>Rivers and Harbors Appropriation Act of 1899</i>
RI	Rhode Island
RI CRMC	Rhode Island Coastal Resources Management Council
RI CRMP	Rhode Island Coastal Resources Management Program
RICR	Rhode Island Code of Regulations
RIDEM	Rhode Island Department of Environmental Management
RIHCC	Rhode Island Historical Cemetery Commission
RIHPHC	Rhode Island Historical Preservation & Heritage Commission
RI-MA WEA	Rhode Island/Massachusetts Wind Energy Area
ROD	Record of Decision
ROI	region of influence
ROW	right-of-way
RSZ	rotor-swept zone
RTE	rare, threatened, and endangered
S/NRHP	State and/or National Register of Historic Places
SAMP	Special Area Management Plan
SAP	Site Assessment Plan
SAR	Search and Rescue
SAV	submerged aquatic vegetation
SCADA	supervisory control and data acquisition

CONSTRUCTION AND OPERATIONS PLAN

SCDHS	Suffolk County Department of Health Services
SCFWH	Significant Coastal Fish and Wildlife Habitats
SEFSC	Southeast Fisheries Science Center
SEL	sound exposure levels
SF6	sulfur hexafluoride
SHPO	State Historic Preservation Office
SIP	State Implementation Plan
SMA	seasonal management area
SNE	southern New England
SO ₂	sulfur dioxide
SOV	service operating vessel
SPCC	spill prevention, control, and countermeasure
SPDES	State Pollutant Discharge Elimination System
SPI/PV	Sediment Profile and Plan View Imaging
SPL	sound pressure level
SPL _{rms}	sound pressure levels, root mean square
SRWEC	Sunrise Wind Export Cable
SRWF	Sunrise Wind Farm
SSS	Side-Scan Sonar
Sunrise Wind	Sunrise Wind LLC
SWLP	seawater lift pump
SWPPP	Stormwater Pollution Prevention Plan
THPO	Tribal Historic Preservation Office
TJB	Transition Joint Bay
TP	transition piece
tpy	tons per year
TSS	total suspended solids
TTS	temporary threshold shift
UME	Unusual Mortality Event
UPS	uninterrupted power supply
US	United States

CONSTRUCTION AND OPERATIONS PLAN

USACE	United States Army Corps of Engineers
USC	United States Code
USCB	United States Census Bureau
USCG	United States Coast Guard
USFWS	United States Fish and Wildlife Service
UXO	unexploded ordnance
VHF	very high frequency
VMS	vessel monitoring system
VOC	volatile organic compound
VRAP	Visual Resource Assessment Procedure
VSA	Visual Study Area
VSR	visually sensitive resource
VTL	Visibility Threshold Level
VTR	vessel trip report
WEA	Wind Energy Area
WTG	Wind Turbine Generator
yBP	years before present
ZVI	Zone of Visual Influence
μPa	micropascals

Table of Contents

Executive Summary	1
SECTION 1 – INTRODUCTION	1-1
1.1 Project Overview	1-1
1.2 Project Design Envelope	1-9
1.3 Project Purpose	1-12
1.4 Regulatory Framework	1-14
1.4.1 BOEM-Led Permits and Approvals	1-19
1.4.2 Other Federal Permits, Approvals, and Consultations.....	1-21
1.4.3 State Permits, Approvals, and Consultations.....	1-24
1.4.4 Local Permits and Approvals.....	1-26
1.5 Agency and Stakeholder Outreach.....	1-26
1.6 Other Project Information	1-29
1.6.1 Authorized Representative and Designated Operator	1-29
1.6.2 Certified Verification Agent.....	1-30
1.6.3 Emergency Response Plan/Oil Spill Response Plan (ERP/OSRP)	1-30
1.6.4 Safety Management Plan.....	1-30
1.6.5 Financial Assurance.....	1-30
1.7 BOEM COP Requirements and Lease Stipulations.....	1-31
SECTION 2 – PROJECT SITING AND DESIGN DEVELOPMENT	2-1
2.1 Siting History	2-1
2.1.1 Siting and Screening of the RI-MA WEA and MA WEA.....	2-5
2.1.2 SRWF Siting and Screening	2-11
2.2 Project Alternatives.....	2-12
2.2.1 Siting Alternatives	2-13
2.2.2 Design Alternatives	2-32
2.2.3 Construction Alternatives.....	2-36
2.3 Summary of Proposed Project.....	2-38
SECTION 3 – DESCRIPTION OF PROPOSED ACTIVITY	3-1
3.1 Project Description.....	3-1
3.1.1 Project Location.....	3-1

CONSTRUCTION AND OPERATIONS PLAN

3.2	Project Infrastructure Overview and Schedule	3-1
3.2.1	Project Infrastructure Overview	3-1
3.2.2	Project Schedule	3-6
3.3	Project Design and Construction Activities.....	3-7
3.3.1	Onshore Converter Station Facilities.....	3-7
3.3.2	Onshore Transmission Facilities	3-13
3.3.3	Sunrise Wind Export Cable	3-24
3.3.4	Layout Design	3-49
3.3.5	Wind Turbine Generator and Offshore Converter Station Foundations.....	3-53
3.3.6	Offshore Converter Station	3-61
3.3.7	Inter-Array Cables	3-64
3.3.8	Wind Turbine Generators	3-67
3.3.9	Measurement Equipment	3-72
3.3.10	Ports, Vessels and Vehicles, Material Transportation, Chemical and Waste Management, and Construction Work Zones.....	3-75
3.4	Commissioning	3-86
3.4.1	Onshore Converter Station	3-86
3.4.2	Offshore Converter Station	3-87
3.4.3	Wind Turbine Generators	3-87
3.5	Operations and Maintenance	3-87
3.5.1	Onshore Facilities	3-88
3.5.2	Offshore Transmission Facilities	3-89
3.5.3	Wind Turbine Generator and Offshore Converter Station Foundations.....	3-90
3.5.4	Wind Turbine Generators	3-91
3.5.5	Ports, Vessels and Vehicle Mobilization and Material Transportation	3-92
3.5.6	Chemical and Waste Management.....	3-95
3.5.7	Lighting and Marking of Offshore Project Components	3-96
3.6	Decommissioning	3-96
SECTION 4 – SITE CHARACTERIZATION AND ASSESSMENT OF IMPACTS.....		4-1
4.1	Characterization and Assessment Approach	4-1
4.2	Impact Producing Factors	4-3
4.2.1	Seafloor and Land Disturbance	4-9

CONSTRUCTION AND OPERATIONS PLAN

4.2.2	Sediment Suspension and Deposition	4-14
4.2.3	Noise	4-18
4.2.4	Electric and Magnetic Fields	4-25
4.2.5	Discharges and Releases	4-28
4.2.6	Trash and Debris	4-31
4.2.7	Traffic (Vessels, Vehicles, Air)	4-32
4.2.8	Air Emissions	4-34
4.2.9	Visible Infrastructure	4-36
4.2.10	Lighting and Marking.....	4-38
4.3	Physical Resources	4-40
4.3.1	Oceanographic and Meteorological Conditions	4-40
4.3.2	Geological Conditions	4-59
4.3.3	Water Quality	4-79
4.3.4	Air Quality.....	4-110
4.4	Biological Resources	4-142
4.4.1	Coastal and Terrestrial Habitat.....	4-142
4.4.2	Benthic and Shellfish Resources	4-168
4.4.3	Finfish and Essential Fish Habitat.....	4-228
4.4.4	Marine Mammals	4-283
4.4.5	Sea Turtles	4-337
4.4.6	Avian Species	4-375
4.4.7	Bats	4-422
4.5	Visual Resources	4-449
4.5.1	Visual Resources	4-449
4.6	Cultural Resources	4-493
4.6.1	Marine Archaeological Resources	4-493
4.6.2	Terrestrial Archaeological Resources	4-505
4.6.3	Above-Ground Historic Properties	4-514
4.7	Socioeconomic Resources	4-532
4.7.1	Employment, Economics, and Demographics	4-534
4.7.2	Public Services.....	4-558

CONSTRUCTION AND OPERATIONS PLAN

4.7.3	Recreation and Tourism	4-567
4.7.4	Commercial and Recreational Fisheries	4-596
4.7.5	Other Marine Uses and Coastal Land Use	4-624
4.7.6	Environmental Justice.....	4-644
4.8	Transportation and Navigation	4-655
4.8.1	Marine Transportation and Navigation	4-655
4.8.2	Land Transportation and Navigation	4-668
4.8.3	Air Transportation and Navigation.....	4-674
4.9	Summary of Potential Impacts and Environmental Protection Measures	4-683
SECTION 5 – REFERENCES		5-1
5.1	Section 1 – Introduction.....	5-1
5.2	Section 2 – Project Siting and Design Development	5-2
5.3	Section 3 – Project Description	5-2
5.4	Section 4 – Site Characterization and Assessment of Impacts.....	5-3
5.4.1	Characterization and Assessment Approach	5-3
5.4.2	Impact Producing Factors	5-3
5.4.3	Physical Resources.....	5-4
5.4.4	Biological Resources.....	5-14
5.4.5	Visual Resources.....	5-75
5.4.6	Cultural Resources	5-75
5.4.7	Socioeconomic Resources	5-77
5.4.8	Transportation and Navigation	5-88

List of Tables

Table 1.2-1 Summary of PDE Parameters 1-11

Table 1.4-1 Summary of Permits, Approvals, and Consultations 1-15

Table 1.5-1 Stakeholder Engagement 1-27

Table 1.6-1 Authorized Representative and Owner 1-29

Table 1.7-1 BOEM Requirements for Developing a Construction and Operations Plan 1-31

Table 1.7-2 Summary of Relevant Lease Requirements for SRWF and SRWEC from OCS-A
0487 1-39

Table 2.2-1 Summary of Sites Evaluated for OnCS-DC 2-17

Table 2.2-2 Summary of Landfall Sites Evaluated 2-21

Table 2.2-3 Summary of Routes Evaluated for Onshore Transmission Cable 2-27

Table 3.3.1-1 Onshore Converter Station Equipment 3-11

Table 3.3.1-2 Summary of Maximum Potential Volumes, Oils, Fuels, Gas and Lubricants for
the Onshore Converter Station 3-11

Table 3.3.1-3 Typical OnCS-DC Construction Sequence 3-12

Table 3.3.1-4 Maximum Disturbance Areas for the OnCS-DC Site 3-13

Table 3.3.2-1 Onshore Interconnection Cable Maximum Design Scenario 3-17

Table 3.3.2-2 Onshore Transmission Cable Maximum Design Scenario 3-18

Table 3.3.2-3 Typical Underground Transmission Cable Construction Sequence 3-19

Table 3.3.2-4 Onshore Transmission/Interconnection Cable Construction Maximum Design
Scenario 3-22

Table 3.3.2-5 Onshore Transmission Cable and Onshore Interconnection Cable Crossing
Locations Maximum Design Scenario 3-23

Table 3.3.3-1 SRWEC Maximum Design Scenario 3-27

Table 3.3.3-2 Landfall HDD Maximum Design Scenario 3-32

Table 3.3.3-3 Maximum Disturbance Areas for SRWEC Landfall 3-33

Table 3.3.3-4 Typical Offshore Export Cable Installation Sequence 3-34

Table 3.3.3-5 Maximum Construction Disturbance Areas for SRWEC 3-43

Table 3.3.3-6 Existing Cable Potential Crossing Locations by the SRWEC and IAC a/ 3-45

Table 3.3.5-1 Summary of WTG and Offshore Converter Station Foundation Types 3-57

Table 3.3.5-2 Maximum Seafloor Disturbance for Foundations 3-58

Table 3.3.5-3 Typical Monopile Installation Sequence 3-59

Table 3.3.5-4 Typical Piled Jacket Foundation Installation Sequence 3-60

Table 3.3.6-1 OCS-DC Maximum Topside Design Scenario 3-63

CONSTRUCTION AND OPERATIONS PLAN

Table 3.3.6-2 Summary of Maximum Potential Volumes Oils, Fuels, Gases and Lubricants for OCS–DC.....	3-63
Table 3.3.6-3 Typical Offshore Converter Station Construction Sequence	3-64
Table 3.3.7-1 Inter-Array Cable Maximum Design Scenario	3-65
Table 3.3.7-2 Maximum Inter-Array Cable Seafloor Disturbance.....	3-67
Table 3.3.8-1 WTG Design Envelope Specifications.....	3-69
Table 3.3.8-2 Summary of Maximum Potential Volumes Oils, Fuels, Gases and Lubricants per WTG.....	3-70
Table 3.3.8-3 Typical WTG Construction Sequence.....	3-71
Table 3.3.10-1 Potential Port Facilities.....	3-77
Table 3.3.10-2 Summary of Equipment to Support Onshore Construction	3-82
Table 3.3.10-3 Summary of Vessels and Helicopters to Support Offshore Construction	3-83
Table 3.3.10-4 Anticipated Solid and Liquid Wastes Generated During Offshore Construction	3-85
Table 3.5.2-1 Routine Maintenance Activities for Offshore Transmission Assets.....	3-89
Table 3.5.3-1 Foundation Maintenance Activities	3-91
Table 3.5.4-1 WTG Maintenance Frequency.....	3-91
Table 3.5.5-1 Summary of O&M Vessels and Helicopters.....	3-94
Table 3.5.6-1 Anticipated Solid and Liquid Wastes Generated During One Year of Offshore Operations	3-95
Table 4.2-1 Anticipated Project Activities and Possible Impact-Producing Factors during Construction, Operations & Maintenance, and Decommissioning of the Project ^a	4-5
Table 4.2-2 Summary of the Evaluation of Impact-producing Factors Associated with the Project and Affected Physical, Biological, Visual, Cultural, Socioeconomic, and Transportation and Navigation Resources	4-7
Table 4.3.1-1 Recorded High Winds for Dukes and Nantucket Counties, Massachusetts and the Northeast Zone of Suffolk County, New York from January 2017 through December 2019	4-52
Table 4.3.1-2 Recorded Storm Events for Barnstable and Nantucket Counties, Massachusetts and the Northeastern Zone of Suffolk County, New York from January 2017 to December 2019.....	4-54
Table 4.3.2-1 Overview of Completed Geophysical and Geotechnical Surveys	4-61
Table 4.3.2-2 Overview of Ongoing and Planned Geotechnical Surveys.....	4-62
Table 4.3.3-1 Average SCDHS Water Quality Monitoring Station Nutrients Data, 2015–2019.....	4-96
Table 4.3.3-2 Metals Detected at SCDHS Carmans River Monitoring Station 95052, 2015–2016.....	4-97
Table 4.3.4-1 Emissions Avoided by Construction of the Project (tons) for Various Pollutants....	4-110

CONSTRUCTION AND OPERATIONS PLAN

Table 4.3.4-2 National Ambient Air Quality Standards for Criteria Pollutants	4-111
Table 4.3.4-3 <i>de minimis</i> Emission Thresholds for Determining <i>Clean Air Act</i> Conformity in Nonattainment Areas.....	4-115
Table 4.3.4-4 <i>de minimis</i> Emission Thresholds for Determining <i>Clean Air Act</i> Conformity in Maintenance Areas.....	4-116
Table 4.3.4-5 Criteria Pollutant Attainment Status for Project Counties	4-118
Table 4.3.4-6 Applicable General Conformity <i>de minimis</i> Thresholds based on Project Counties' Attainment Status.....	4-119
Table 4.3.4-7 Estimated OCS Permit Emissions during Construction of the Sunrise Wind Project	4-131
Table 4.3.4-8 Estimated Emissions in Federal Waters Outside the OCS Area during Construction of the Sunrise Wind Project	4-132
Table 4.3.4-9 Estimated General Conformity Emissions during Construction of the Sunrise Wind Project	4-133
Table 4.3.4-10 Estimated Emissions during Operations and Maintenance of the Sunrise Wind Project	4-135
Table 4.3.4-11 Emissions Avoided by Construction of the Project (tons) for Various Pollutants.....	4-141
Table 4.4.1-1 RTE and NYS Watch List Plant Species Documented by NYSDEC or USFWS within the Vicinity of Onshore Facilities and Occurrence Based on Field Surveys.....	4-149
Table 4.4.1-2 NYSDOS Significant Coastal Fish and Wildlife Habitats and NYNHP Significant Natural Communities.....	4-151
Table 4.4.1-3 Summary of Wetland and Waterbody Resources Observed for Onshore Facilities	4-154
Table 4.4.1-4 Summary of Coastal and Terrestrial Habitats Observed for Onshore Facilities	4-161
Table 4.4.1-5 Anticipated Impacts to Waterbodies or Wetlands.....	4-164
Table 4.4.2-1 Description of General Macrohabitat Types Observed at the SRWF, SRWEC–OCS, and Reference Areas	4-185
Table 4.4.2-2 Summary of the Sediment Transport Modeling Results	4-208
Table 4.4.3-1 Economically and Ecologically Important Finfish Species in the SRWF, SRWEC, and Onshore Transmission Cable	4-241
Table 4.4.3-2 Common Habitat Types for Finfish Species Known to Occur in the Region	4-247
Table 4.4.3-3 EFH Designations for Species in the SRWF, SRWEC, and Onshore Transmission Cable.....	4-251
Table 4.4.3-4 Common Prey Species of Juvenile and Adult Finfish Species	4-254
Table 4.4.4-1 Marine Mammals Potentially Occurring Within the Regional Waters of the Western North Atlantic OCS and Project Area	4-295

CONSTRUCTION AND OPERATIONS PLAN

Table 4.4.4-2 Summary of NOAA Fisheries (2012) Behavioral Onset Acoustic Threshold Criteria for Impulsive and Non-Impulsive Sounds	4-310
Table 4.4.5-1 Listed Species with Potential Occurrence in the Regional Waters of the Western North Atlantic OCS and Project Area	4-341
Table 4.4.5-2 Physiological and Behavioral Threshold Criteria for Impulsive and Non-Impulsive Sounds for Sea Turtles	4-354
Table 4.4.6-1 Timing, Distribution, and Status of Avian Species Groups Likely to Occur within or Proximate to the Project Area	4-379
Table 4.4.6-2 Timing, Distribution, and Status of Avian Species Observed During Regional Surveys that are Likely to Occur within or Proximate to the SRWF	4-389
Table 4.4.6-3 Timing, Distribution, and Status of Additional Avian Species Likely to Occur within or Proximate to the SRWEC–OCS based on Regional NYSERDA Survey Data.....	4-393
Table 4.4.6-4 Timing, Distribution, and Status of Avian Species Groups Likely to Occur within or Proximate to the Onshore Facilities.....	4-397
Table 4.4.7-1 Bat Species on Long Island that Could Occur Within or Proximate to the SRWEC–NYS and Onshore Facilities	4-426
Table 4.4.7-2 Bat Species Detected during Vessel-based Acoustic Surveys for Regional Offshore Wind Projects	4-428
Table 4.4.7-3 Monthly Timing of Calls during Vessel-based Acoustic Surveys for Regional Offshore Wind Projects	4-429
Table 4.5.1-1 States, Counties, and Towns Within the SRWF Visual Study Area	4-453
Table 4.5.1-2 KOPs With Minimal or No Visibility of the SRWF	4-461
Table 4.5.1-3 KOPs Selected for Visual Simulations of the SRWF.....	4-462
Table 4.5.1-4 Blade Tip – Land Area Viewshed Results Summary.....	4-475
Table 4.5.1-5 Visual Impact Assessment Rating Panel Results	4-478
Table 4.5.1-6 Aviation Obstruction Lights – Land Area Viewshed Results Summary	4-487
Table 4.5.1-7 Viewpoints Selected for Nighttime Visual Simulations	4-487
Table 4.5.1-8 Visually Sensitive Resources with Potential OnCS–DC Visibility (Within OnCS–DC ZVI).....	4-490
Table 4.6.3-1 Distance from WTG to Shoreline within the VSA.....	4-525
Table 4.7-1 States, Counties, and Communities within the Socioeconomic Region of Influence	4-533
Table 4.7.1-1 Population Characteristics within the Primary Region of Interest	4-535
Table 4.7.1-2 Current-Dollar Gross Domestic Product by State for the First Quarters of 2018 and 2019	4-538
Table 4.7.1-3 Percent Employed Civilian Population by Industry in the States in the Primary (and Expanded) Region of Interest	4-540

CONSTRUCTION AND OPERATIONS PLAN

Table 4.7.1-4 Percent Employed Civilian Population by Industry in the Counties in the Primary Region of Interest	4-541
Table 4.7.1-5 Summary of Ocean-related Tourism Indicators within the Expanded Region of Interest	4-544
Table 4.7.1-6 Employment Characteristics for States and Counties in the Primary Region of Interest	4-545
Table 4.7.1-7 Housing Characteristics within the Primary Region of Interest	4-546
Table 4.7.1-8 Vacant Housing Characteristics within the Primary Region of Interest	4-548
Table 4.7.1-9 Housing Values within the States in the Primary and Expanded Region of Interest	4-552
Table 4.7.1-10 Housing Values within the Counties in the Primary and Expanded Region of Interest	4-553
Table 4.7.2-1 Hospitals Closest to Project Construction and O&M Activities: Selected Statistics	4-560
Table 4.7.2-2 Fire, EMS, and Law Enforcement Services at Onshore Locations Potentially Supporting Construction, Operations, and Maintenance Activities	4-563
Table 4.7.3-1 Sailboat, Distance, and Buoy Races in or Near Rhode Island Sound and Block Island Sound	4-573
Table 4.7.3-2 Sailboat, Distance, and Buoy Races in or Near Long Island Bays and the Atlantic Ocean	4-575
Table 4.7.3-3 Inventory and Summary of Water-Based and Waterfront-Dependent Recreation and Tourism Resources by County within the Expanded Region of Interest	4-587
Table 4.7.4-1 Stakeholders and Gears Used to Fish in the SRWF or the Vicinity of SRWEC	4-600
Table 4.7.4-2 Commercial Fisheries Most Active in the SRWF with a 1-km Buffer	4-601
Table 4.7.4-3 Commercial Fisheries Most Active in the SRWEC–OCS and SRWEC–NYS with a 10-km-wide Fisheries Study Corridor	4-602
Table 4.7.5-1 Other Marine Uses within the Vicinity of the Project	4-631
Table 4.7.6-1 Environmental Justice Offices and Policies for States in the Primary and Expanded Region of Interest	4-647
Table 4.7.6-2 2018 Income and Minority Population Levels in the Primary Region of Interest...	4-649
Table 4.8.1-1 Summary of Search And Rescue Cases in the Sunrise Wind Farm.....	4-661
Table 4.8.3-1 Summary of Airports in the Vicinity of Onshore Facilities.....	4-679
Table 4.8.3-2 Summary of Potential Impacts and Environmental Protection Measures, by Resource	4-685

List of Figures

Figure 1.1-1 Project Location 1-5

Figure 1.1-2 Onshore Facilities 1-7

Figure 1.1-3 Simplified Project Schematic 1-9

Figure 2.1-1 Location of Lease Areas OCS-A 0486, 0487, 0500, and 0517 2-3

Figure 2.1-2 Siting History for Lease OCS-A 0487 2-9

Figure 2.2-1 OnCS-DC Site Alternatives 2-15

Figure 2.2-2 Landfall Site Alternatives 2-19

Figure 2.2-3 Onshore Transmission Cable Route Alternatives 2-25

Figure 2.2-4 SRWEC and AC Booster Station Alternatives 2-29

Figure 2.2-5 Alternative Foundation Concepts for WTG and OCS-DC 2-35

Figure 3.2.1-1 Project Overview 3-3

Figure 3.2.1-2 Overview of Project Infrastructure 3-5

Figure 3.2.2-1 Indicative Project Construction Schedule 3-6

Figure 3.3.1-1 Union Avenue Site and Onshore Interconnection Cable 3-9

Figure 3.3.2-1 Onshore Transmission Cable Route Options 3-15

Figure 3.3.2-2 Typical Onshore Single-Phase Cable Cross-Section 3-17

Figure 3.3.2-3 Typical Onshore Single-Phase Cable Cross-Section 3-18

Figure 3.3.2-4 Typical Installation Configuration of Underground Onshore Transmission
Circuit 3-20

Figure 3.3.2-5 Typical Underground Onshore Transmission Circuit Installation within a Road
Right-of-Way 3-21

Figure 3.3.2-6 Typical Installation Configuration of Underground Onshore Interconnection
Circuit 3-22

Figure 3.3.3-1 Example TJBs and Link Boxes 3-25

Figure 3.3.3-2 Typical DC Subsea Cable Cross-Section 3-26

Figure 3.3.3-3 Landfall/ICW Work Area 3-29

Figure 3.3.3-4 Simplified Landfall HDD Schematic 3-31

Figure 3.3.3-5 Typical Boulder Grab Configuration 3-36

Figure 3.3.3-6 Typical Boulder Plow Configuration 3-36

Figure 3.3.3-7 Typical Configuration of a Simultaneous Lay and Bury Mechanical Plow,
Aided by Pull Anchor and Tugboat 3-39

Figure 3.3.3-8 Typical Configuration of a Jet Plow (Post-lay Burial) 3-40

Figure 3.3.3-9 Typical Configuration of a Pre-cut Mechanical Plow 3-41

CONSTRUCTION AND OPERATIONS PLAN

Figure 3.3.3-10 Existing Cables Crossed by the SRWEC	3-47
Figure 3.3.4-1 Indicative SRWF Layout Design	3-51
Figure 3.3.5-1 Conceptual Monopile Foundation with Secondary Structure after Installation	3-55
Figure 3.3.5-2 Conceptual Piled Jacket Foundation	3-56
Figure 3.3.8-1 Conceptual Rendering of the Minimum and Maximum WTGs under Consideration	3-68
Figure 3.3.10-1 Location of Potential Port Facilities	3-79
Figure 4.1-1 Illustration of Steps Involved in the Proposed Impact Assessment.....	4-2
Figure 4.3.1-1 HYCOM Monthly Current Speed Statistics from January 2001 to December 2010	4-42
Figure 4.3.1-2 Vertical Profile of the HYCOM 2001-2010 Horizontal Current Speeds Dataset	4-43
Figure 4.3.1-3 Monthly Averaged HYCOM Surface Currents near the SRWF from January 2001 to December 2010	4-44
Figure 4.3.1-4 Peak Bottom Currents During a Flood Event on April 6, 2016 at 21:00	4-45
Figure 4.3.1-5 Peak Surface Currents During a Flood Event on April 6, 2016 at 21:00.....	4-46
Figure 4.3.1-6 Peak Bottom Currents During an Ebb Event on April 7, 2016 at 03:00.....	4-46
Figure 4.3.1-7 Peak Surface Currents During an Ebb Event on April 7, 2017 at 03:00	4-47
Figure 4.3.1-8 Seasonal Water Temperature Based on Data Collected Between 1980 and 2007	4-48
Figure 4.3.1-9 Seasonal Water Salinities at Sea Surface (Depth 0 m) Based on Data Collected Between 1980 and 2007.....	4-49
Figure 4.3.1-10 Monthly Wind Roses Based on CFSR Model Results from 2001 to 2010	4-50
Figure 4.3.1-11 CFSR Monthly Wind Speed Statistics Based on Model Results from 2001 to 2010	4-51
Figure 4.3.1-12 Tracks of Cyclones that Passed Within 30 Nautical Miles of SRWF Between 1900 and 2019	4-55
Figure 4.3.1-13 Hurricane Strike Density Map by County from 1900 to 2010.....	4-56
Figure 4.3.1-14 Monthly Mean (center point), Standard Deviation (red bars), Minimum and Maximum (end points) Air Temperatures at NDBC Buoy Station 44017	4-57
Figure 4.3.1-15 Impact-Producing Factors on Physical Oceanography and Meteorology	4-58
Figure 4.3.2-1 Regional Generalized Geographic Characteristics	4-65
Figure 4.3.2-2 Generalized Cross-section from de Laguna (1965)	4-68
Figure 4.3.2-3 Terrestrial Surficial Sediments	4-69
Figure 4.3.2-4 Impact-Producing Factors on Geological Conditions	4-72
Figure 4.3.3-1 Mid-Atlantic Bight and New York Bight Regions and Waterbodies Crossed by the Project	4-81

CONSTRUCTION AND OPERATIONS PLAN

Figure 4.3.3-2 Average Monthly Chlorophyll a Concentrations in Offshore New York/Rhode Island Surface Waters from 2007 to 2016 (Marine Cadastre 2019).....	4-84
Figure 4.3.3-3 Esri Ecological Marine Units Project Data Collection Locations, 1955-2012.....	4-86
Figure 4.3.3-4 Average Monthly Chlorophyll a Concentrations in Coastal New York Waters from 2007 to 2016 (Marine Cadastre 2019)	4-90
Figure 4.3.3-5 Location of Nearest SCDHS Monitoring Locations Relative to the Project Area	4-93
Figure 4.3.3-6 Impact Producing Factors on Water Quality.....	4-99
Figure 4.3.4-1 Air Quality Study Area	4-123
Figure 4.3.4-2 Impact Producing Factors on Air Quality.....	4-137
Figure 4.4.1-1 Landfall/ICW Study Area.....	4-143
Figure 4.4.1-2 Significant and Critical Natural Communities and Habitats.....	4-147
Figure 4.4.1-3 Wetlands and Waterbodies.....	4-155
Figure 4.4.1-4 Impact-Producing Factors on Coastal and Terrestrial Habitat	4-162
Figure 4.4.2-1 Recent Studies of Benthic Biology and/or Geology	4-171
Figure 4.4.2-2 Bivalve Densities	4-175
Figure 4.4.2-3 Macrohabitat Type at the SRWF, Derived from a Subset of Physical and Biological Parameters Obtained from SPI and PV Imagery.....	4-183
Figure 4.4.2-4 Maximum CMECS Gravel Size Category (PV) SRWF.....	4-189
Figure 4.4.2-5 Macrohabitat Type at the SRWEC–OCS (Western), Derived from a Subset of Physical and Biological Parameters Obtained from SPI and PV Imagery.....	4-193
Figure 4.4.2-6 Macrohabitat Type at the SRWEC–OCS (Eastern), Derived from a Subset of Physical and Biological Parameters Obtained from SPI and PV Imagery.....	4-195
Figure 4.4.2-7 Macrohabitat Types along the SRWEC–NYS.....	4-201
Figure 4.4.2-8 Impact-Producing Factors on Benthic and Shellfish Resources	4-204
Figure 4.4.3-1 Long Island South Shore Benthic Habitat.....	4-239
Figure 4.4.3-2 Impact-Producing Factors on Finfish and Essential Fish Habitat	4-257
Figure 4.4.4-1 OBIS-SEAMAP Baleen Whale Sightings Data, 1960–2019.....	4-289
Figure 4.4.4-2 OBIS-SEAMAP Toothed Whale Sightings Data 1974–2019	4-291
Figure 4.4.4-3 OBIS-SEAMAP Seal Sightings Data, 1979–2019.....	4-293
Figure 4.4.4-4 Impact-Producing Factors on Marine Mammals	4-306
Figure 4.4.5-1 OBIS–SEAMAP Sea Turtle Sightings Data, 1963–2019.....	4-345
Figure 4.4.5-2 Impact-Producing Factors on Sea Turtles	4-351
Figure 4.4.6-1 Locations of Relevant Regional Bird Surveys	4-377
Figure 4.4.6-2 Bird Abundance Estimates (All Species) from the MDAT Models.....	4-383

CONSTRUCTION AND OPERATIONS PLAN

Figure 4.4.6-3 Impact-Producing Factors on Avian Species	4-399
Figure 4.4.7-1 Bat Detections during Regional Vessel Based Acoustic Bat Surveys	4-423
Figure 4.4.7-2 Locations of Bat Detections (Vessel Positions) during Regional Vessel-Based Acoustic Bat Surveys	4-433
Figure 4.4.7-3 Impact-Producing Factors on Bat Species	4-439
Figure 4.5.1-1 Sunrise Wind Farm Visual Study Area	4-451
Figure 4.5.1-2 Sunrise Wind Farm Zone of Visual Influence	4-455
Figure 4.5.1-3 Turbine Visibility	4-459
Figure 4.5.1-4 Key Observation Point Locations SRWF VSA	4-465
Figure 4.5.1-5 OnCS-DC Visual Study Area and Zone of Visual Influence	4-469
Figure 4.5.1-6 Impact-Producing Factors on Visual Resources	4-473
Figure 4.5.1-7 Relationship Between Distance from SRWF and Visual Impact Score	4-484
Figure 4.6.1-1 Sunrise Wind Farm Marine Archaeology PAPE	4-495
Figure 4.6.1-2 Sunrise Wind Export Cable Marine Archaeology PAPE	4-497
Figure 4.6.1-3 Impact-Producing Factors on Marine Archaeological Resources	4-501
Figure 4.6.2-1 Sunrise Wind Farm Terrestrial Archaeology PAPE	4-507
Figure 4.6.2-2 Impact-Producing Factors on Terrestrial Archaeological Resources	4-511
Figure 4.6.3-1 Sunrise Wind Farm Preliminary Area of Potential Effect	4-515
Figure 4.6.3-2 OnCS-DC Preliminary Area of Potential Effect	4-517
Figure 4.6.3-3 Impact-Producing Factors on Above-Ground Historic Properties	4-522
Figure 4.7.2-1 Impact-Producing Factors on Public Services	4-565
Figure 4.7.3-1 Recreational Boating Routes and Recreational Boating Density	4-571
Figure 4.7.3-2 Wildlife Viewing Areas Near the SWRF and SWREC	4-579
Figure 4.7.3-3 Scuba Diving Areas near the SRWF and SRWEC	4-583
Figure 4.7.3-4 Impact-Producing Factors on Recreation and Tourism	4-589
Figure 4.7.4-1 Impact-Producing Factors on Commercial and Recreational Fisheries	4-604
Figure 4.7.5-1 Other Marine Uses	4-625
Figure 4.7.5-2 Existing Land Uses	4-637
Figure 4.7.5-3 Impact-Producing Factors on Other Marine Uses and Coastal Land Use	4-639
Figure 4.8.1-1 Existing Marine Traffic for the Marine Traffic Study Area	4-657
Figure 4.8.1-2 Distribution of vessel tracks in the Marine Traffic Study Area (July 1, 2018 to June 30, 2019)	4-659
Figure 4.8.1-3 Impact-Producing Factors on Marine Transportation and Navigation	4-662
Figure 4.8.2-1 Impact-Producing Factors on Land Transportation	4-670

CONSTRUCTION AND OPERATIONS PLAN

Figure 4.8.3-1 Existing Airports Within Vicinity of Project	4-677
Figure 4.8.3-2 Impact-Producing Factors on Air Transportation and Navigation.....	4-680

Appendices

Appendix A	Agency Correspondence
Appendix B	Fisheries Communication Plan
Appendix C	Coastal Zone Management Consistency Certifications
Appendix D	Certified Verification Agent—CONFIDENTIAL Not for Public Disclosure
Appendix E1	Emergency Response Plan / Oil Spill Response Plan—CONFIDENTIAL Not for Public Disclosure
Appendix E2	Safety Management System—CONFIDENTIAL Not for Public Disclosure
Appendix F	Conceptual Project Engineering Design Drawings / Additional Project Information—CONFIDENTIAL Not for Public Disclosure
Appendix G1	Marine Site Investigation Report—CONFIDENTIAL Not for Public Disclosure
Appendix G2	Munitions and Explosives of Concern (MEC) and Unexploded Ordnance (UXO) Risk Assessment with Risk Mitigation Strategy—CONFIDENTIAL Not for Public Disclosure
Appendix G3	Foundation Feasibility Assessment—CONFIDENTIAL Not for Public Disclosure
Appendix G4	Cable Burial Feasibility Assessment—CONFIDENTIAL Not for Public Disclosure
Appendix H	Sediment Transport Modeling Report
Appendix I1	Underwater Acoustic Assessment—CONFIDENTIAL Not for Public Disclosure
Appendix I2	Onshore Acoustic Assessment
Appendix I3	Offshore In-Air Acoustic Assessment
Appendix J1	Offshore EMF Assessment
Appendix J2	Onshore EMF Assessment
Appendix K	Air Quality Emissions Calculations and Methodology—CONFIDENTIAL Not for Public Disclosure
Appendix L	Onshore Ecological Assessment and Field Survey Report
Appendix M1	Benthic Resources Characterization Report – Federal Waters
Appendix M2	Benthic Resources Characterization Report – New York State Waters
Appendix M3	Benthic Habitat Mapping Report
Appendix N	Essential Fish Habitat Assessment

CONSTRUCTION AND OPERATIONS PLAN

Appendix O	Marine Mammals, Sea Turtles, and ESA-Listed Fish Species Assessment
Appendix P	Avian and Bat Risk Assessment
Appendix Q1	Offshore Visual Impacts Assessment—CONFIDENTIAL Not for Public Disclosure
Appendix Q2	Onshore Visual Resources Assessment
Appendix R	Marine Archaeological Resources Assessment—CONFIDENTIAL Not for Public Disclosure
Appendix S1	Terrestrial Archaeological Resources Assessment—CONFIDENTIAL Not for Public Disclosure
Appendix S2	Terrestrial Archaeological Resources Phase 1B Assessment—CONFIDENTIAL Not for Public Disclosure
Appendix T	Historic Resources Visual Effects Assessment —CONFIDENTIAL Not for Public Disclosure
Appendix U	Onshore Above-ground Historic Properties Report—CONFIDENTIAL Not for Public Disclosure
Appendix V	Commercial and Recreational Fisheries Data Report
Appendix W	Economic Modeling Report—CONFIDENTIAL Not for Public Disclosure
Appendix X	Navigation Safety Risk Assessment
Appendix Y1	Obstruction Evaluation and Airspace Analysis / Radar and Navigational Aid Screening Study
Appendix Y2	Air Traffic Flow Analysis /ADLS Analysis

CONSTRUCTION AND OPERATIONS PLAN

Introduction – Project Overview

SECTION 1 – INTRODUCTION

Sunrise Wind LLC (Sunrise Wind) is submitting this Construction and Operations Plan (COP) to support the siting and development of the Sunrise Wind Farm (SRWF) and the Sunrise Wind Export Cable (SRWEC) (collectively, the Sunrise Wind Farm Project or Project).

The purpose of this COP is to provide information about the Project to the Bureau of Ocean Energy Management (BOEM) and other federal and state agencies.

The COP includes the following:

- A description of the siting and development process and depiction of all planned facilities, including onshore and support facilities;
- A description of proposed activities, including construction, commercial operations and maintenance (O&M), and conceptual decommissioning activities;
- The basis for the analysis of the potential environmental and socioeconomic impacts and operational integrity of the proposed construction, O&M, and decommissioning activities; and;
- Information to support relevant federal permit applications and consultations.

The COP was prepared in accordance with Title 30 of the Code of Federal Regulations (CFR) Part 585 (30 CFR § 585), BOEM's *Information Guidelines for a Renewable Energy Construction and Operations Plan* (BOEM 2020), and other BOEM policy, guidance, and regulations as summarized in Section 1.7 (Table 1.7-1). Table 1.7-2 in the same section includes the location in the COP of relevant lease stipulations for the Project.

1.1 Project Overview

Sunrise Wind, a 50/50 joint venture between Orsted North America Inc. (Orsted NA or Orsted) and Eversource Investment LLC (Eversource), proposes to construct, own, and operate the Sunrise Wind Farm Project. The wind farm portion of the Project (i.e., the SRWF) will be located on the Outer Continental Shelf (OCS) in the designated BOEM Renewable Energy Lease Area OCS-A 0487 (Lease Area)². The Lease Area is approximately 18.9 statute miles (mi) (16.4 nautical miles [nm], 30.4 kilometers [km]) south of Martha's Vineyard, Massachusetts, approximately 30.5 mi (26.5 nm, 48.1 km) east of Montauk, New York (NY), and 16.7 mi (14.5 nm, 26.8 km) from Block Island, Rhode Island (Figure 1.1-1). The Lease Area contains portions of areas that were originally awarded through the BOEM competitive renewable energy lease auctions of the Wind Energy Area (WEA) off the shores of Rhode Island and Massachusetts.

² A portion of Lease Area OCS-A 0500 (Bay State Wind LLC) and the entirety of Lease Area OCS-A 0487 (formerly Deepwater Wind New England LLC) were assigned to Sunrise Wind LLC on September 3, 2020, and the two areas were merged and a revised Lease OCS-A 0487 was issued on March 15, 2021. Thus, when using the term "Lease Area" within this COP, Sunrise Wind is referring to the new merged Lease Area OCS-A 0487.

CONSTRUCTION AND OPERATIONS PLAN

Introduction – Project Overview

Other components of the Project will be located in federal waters on the OCS, in state waters of New York, and onshore in the Town of Brookhaven, Long Island, New York. The onshore components are depicted in Figure 1.1-2. The proposed interconnection location for the Project is the Holbrook Substation, which is owned and operated by the Long Island Power Authority (LIPA).³ Sunrise Wind executed a contract with the New York State Energy Research and Development Authority (NYSERDA) for a 25-year Offshore Wind Renewable Energy Certificate (OREC) Agreement in October 2019.

The Project's components are generally defined into four categories, as depicted in Figure 1.1-2.

- SRWF, inclusive of the Wind Turbine Generators (WTGs), Offshore Converter Station (OCS-DC), and Inter-Array Cables (IAC);
- SRWEC-OCS, inclusive of up to 100 mi (161 km) of the SRWEC in federal waters on the OCS;
- SRWEC-NYS, inclusive of up to 6.2 mi (10 km) of the SRWEC in New York State (NYS) waters and 1,575 ft (480 m) of the SRWEC located onshore (i.e., above the Mean High Water Line [MHWL], as defined by the United States [US] Army Corps of Engineers [USACE] [33 CFR 329]) and underground, up to the Transition Joint Bays (TJBs); and
- Onshore Facilities, inclusive of an up to 17.5-mi (28.2-km) Onshore Transmission Cable, a new Onshore Converter Station (OnCS-DC), and Onshore Interconnection Cable.

The Project will specifically include the following offshore and onshore components, which are described in further detail in Section 3.0:

- Onshore:
 - Onshore Transmission Cable, TJBs, and concrete and/or direct buried joint bays and associated components;
 - Onshore Interconnection Cable;
 - Fiber optic cable co-located with the Onshore Transmission and Onshore Interconnection Cables; and
 - One OnCS-DC.

³ Upgrades to the existing LIPA substation and electrical grid beyond the substation may occur. The scope of any potential upgrades is not known at this time as the required Independent System Operator System Impact Studies and Facility Studies have not been finalized. The execution of any upgrades at the existing substation and of the broader electrical grid, and the specific permitting, engineering, and design requirements to achieve the upgrades, will be performed by LIPA and as such are not addressed in this COP.

CONSTRUCTION AND OPERATIONS PLAN

Introduction – Project Overview

- Offshore:
 - Up to 122 WTGs;
 - Up to 123 foundations (for WTGs and OCS–DC);
 - Up to 186 mi (300 km) of IAC;
 - One Offshore Converter Station (OCS–DC); and
 - One DC submarine export cable bundle (SRWEC) comprised of two cables located within an up to 106 mi (170 km)-long corridor.

This page intentionally left blank

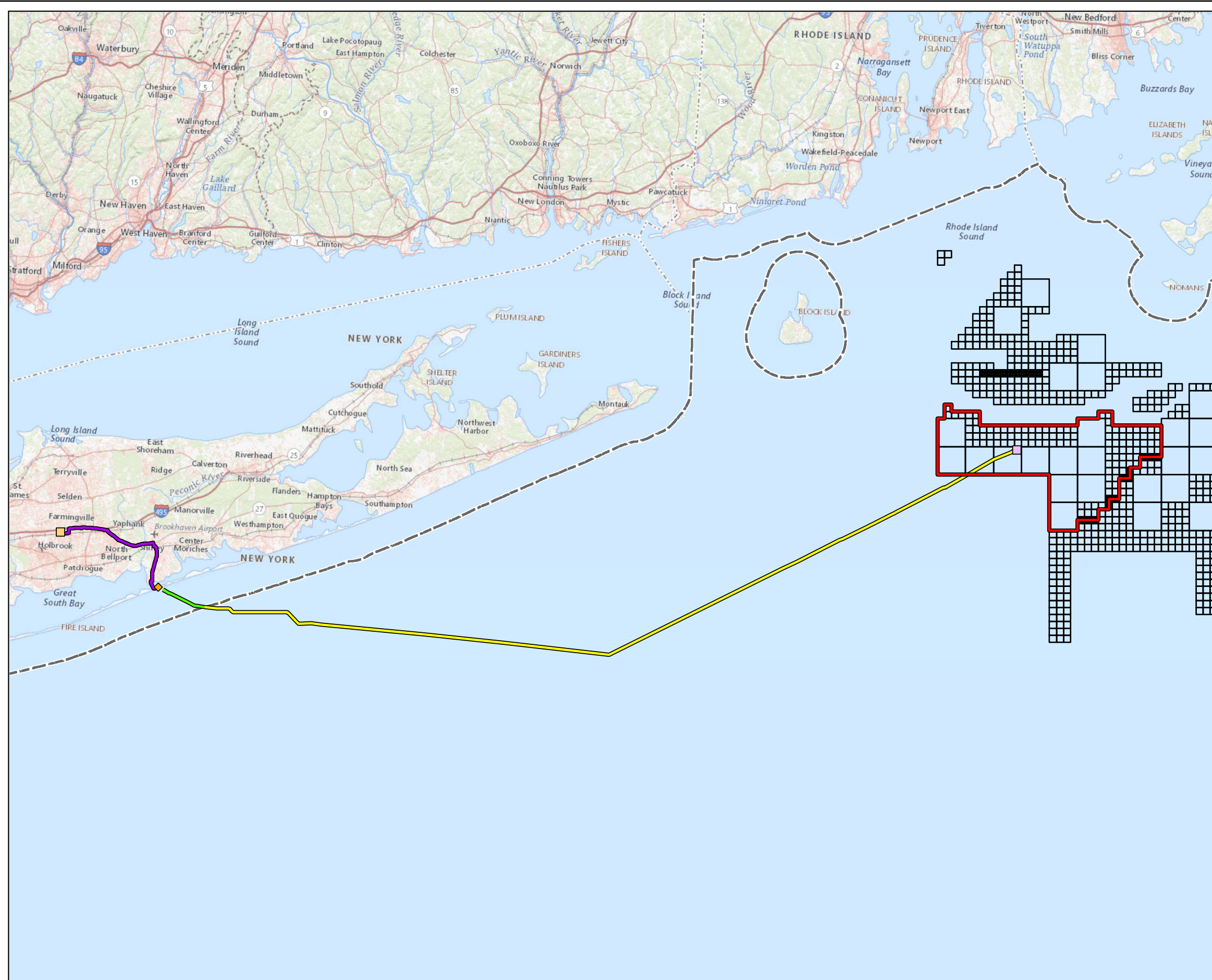

**Figure 1.1-1
Project Location**

Sunrise Wind | Powered by Ørsted & Eversource

- Legend**
- Sunrise Wind Farm (SRWF)
 - Offshore Converter Station (OCS-DC)
 - Onshore Converter Station (OnCS-DC)
 - Sunrise Wind Export Cable (SRWEC-OCS)
 - Sunrise Wind Export Cable (SRWEC-NYS)
 - Onshore Transmission Cable
 - LIE Service Road Route
 - 3-nm State Waters Boundary
 - BOEM OCS Lease Block

Note
Routes are indicative and subject to engineering design changes.

Sources
1. Base map: USGS The National Map



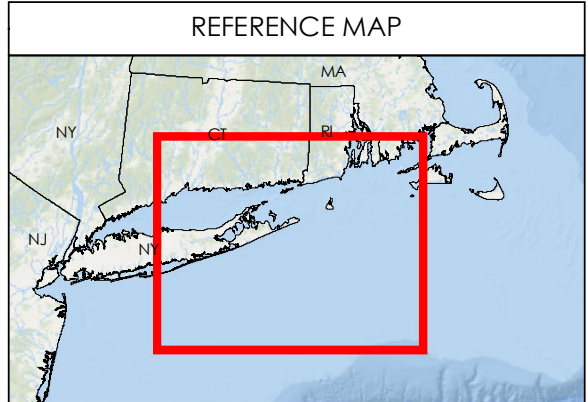
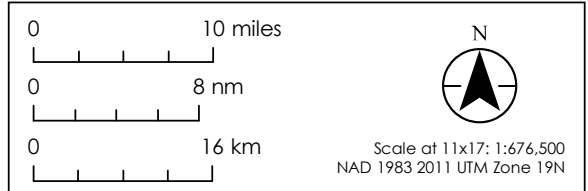









Date	12/18/2020 Revised: 6/1/2021
Project Number	2028113199
Prepared By	PB
Reviewed By	LJ



This page intentionally left blank

**Figure 1.1-2
Onshore Facilities**

Sunrise Wind | Powered by Ørsted & Eversource

- Legend**
-  Sunrise Wind Farm (SRWF)
 -  Sunrise Wind Export Cable (SRWEC-OCS)
 -  Sunrise Wind Export Cable (SRWEC-NYS)
 -  SRWEC-NYS (Western Landfall Option)
 -  Landfall HDD A
 -  Landfall HDD B
 -  Landfall HDD C
 -  Intracoastal Waterway HDD (ICW HDD)
 -  Onshore Transmission Cable
 -  LIE Service Road Route
 -  Onshore Interconnection Cable Route
 -  Union Avenue Site / Onshore Converter Station (OnCS-DC)
 -  Holbrook Substation

Notes
1. SRWEC route will have one landfall location. Routes are indicative and subject to engineering design changes.

Sources
Base map: USGS The National Map

Date	12/18/2020 Revised: 6/1/2021
Project Number	2028113199
Prepared By	PB
Reviewed By	LJ

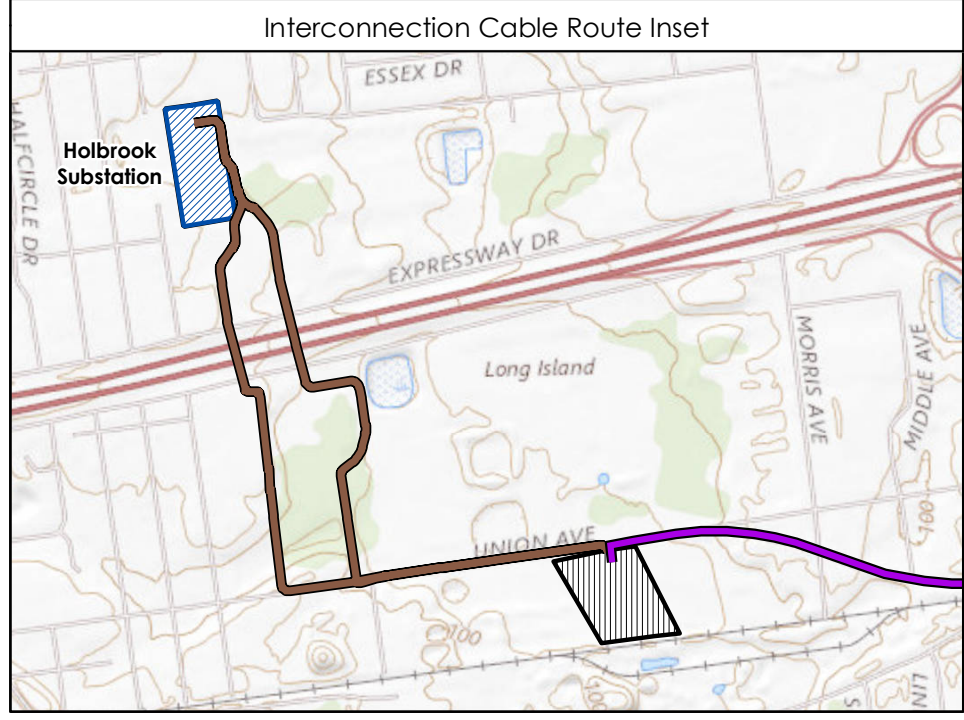
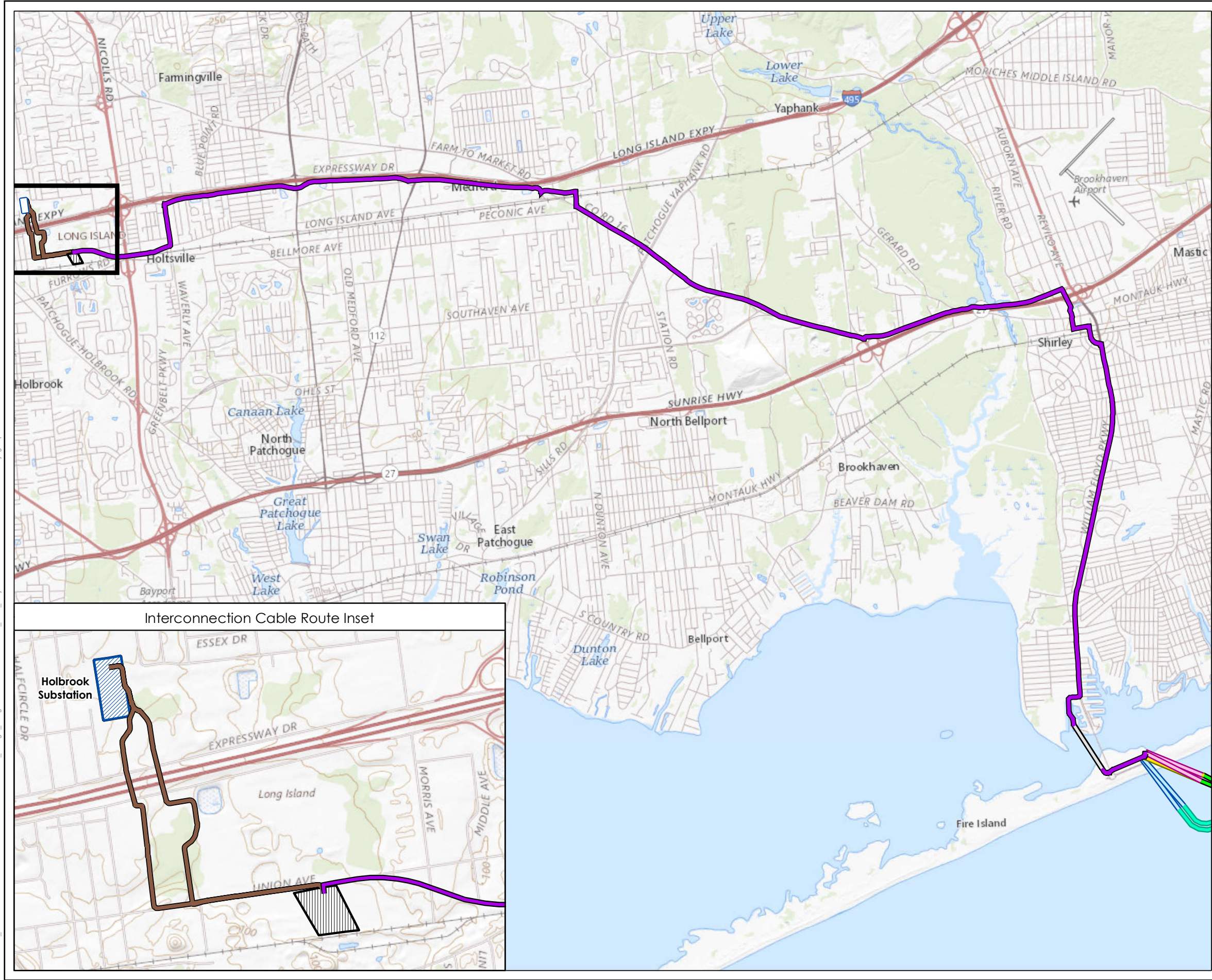
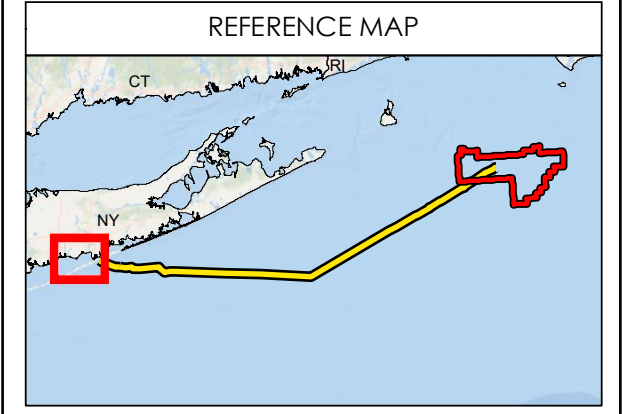
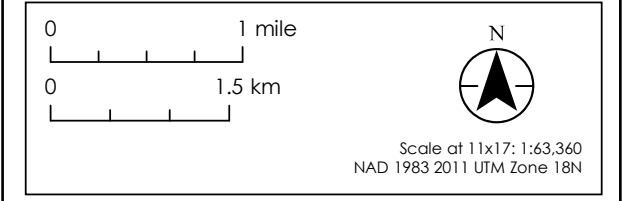

V:\1956\active_Task Owner and other Non-BC1956_Jobs\2028113199_03_data\gis_cad\gis\mxd\COP\2028113199_1-1-2_ProjectOnshore.mxd Revised: 2021-05-18 By: gcarpenter

This page intentionally left blank

CONSTRUCTION AND OPERATIONS PLAN

Introduction – Project Design Envelope

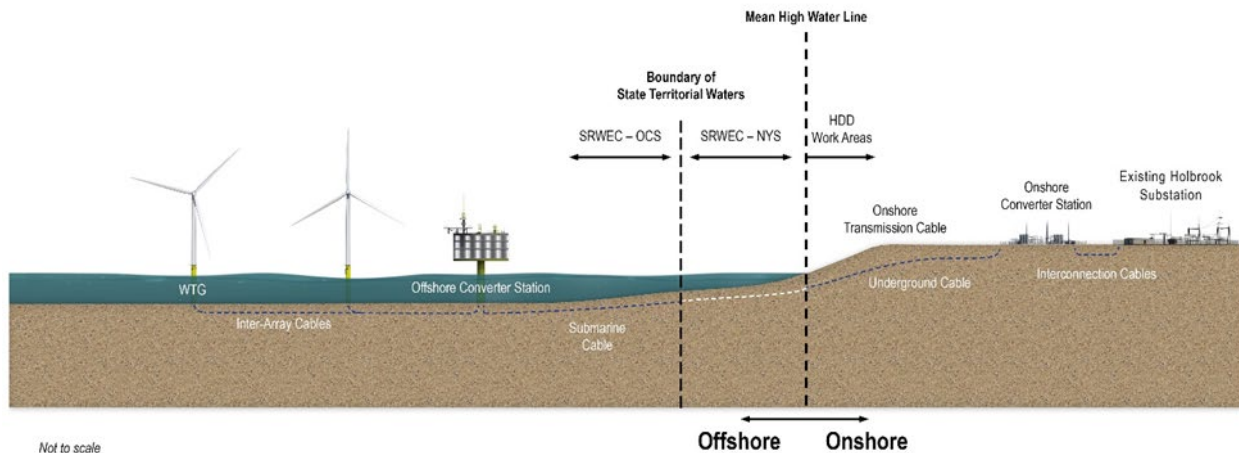

Figure 1.1-3 Simplified Project Schematic

Construction of the Project is expected to be supported by one or more temporary construction laydown yards(s) and construction port(s). The O&M phase of the Project will be supported by onshore O&M facilities.

Sunrise Wind is evaluating the potential use of several existing port facilities in New York, Connecticut, Maryland, Massachusetts, New Jersey, Rhode Island, and Virginia. At this time, no final determination has been made concerning the specific location(s) of these activities. Section 3.3.9.4 of this COP provides further detail regarding potential port options being considered.

1.2 Project Design Envelope

Development of an offshore wind farm is an extensive and complex process spanning several years. In addition, offshore wind technologies, including but not limited to WTGs, foundations, cable transmission, and installation techniques, are rapidly advancing and evolving. The flexibility to take advantage of industry advancements and innovative technologies as a project progresses through development (inclusive of the permitting, detailed engineering design, and procurement processes) is critical so that the most technologically sound, environmentally appropriate, and cost-effective project is constructed.

CONSTRUCTION AND OPERATIONS PLAN

Introduction – Project Design Envelope

For these reasons, BOEM issued a guidance document entitled *Draft Guidance Regarding the Use of a Project Design Envelope in a Construction and Operations Plan* (BOEM 2018). A project design envelope (PDE) is defined as “a reasonable range of project designs” associated with various components of a project (e.g., foundation and WTG options) (BOEM 2018). The PDE is used to assess the potential maximum impacts on key environmental and human use resources (e.g., marine mammals, fish, benthic habitats, commercial fisheries, and navigation), focusing on the design parameter (within the defined range) that represents the greatest potential impact (i.e., the maximum design scenario) for each unique resource (BOEM 2018).

The primary goal of applying a PDE is to allow for meaningful assessments by the jurisdictional agencies of the proposed project elements and activities while concurrently providing the developer reasonable flexibility to make prudent development and design decisions prior to construction. Jurisdictional agencies' evaluation of the maximum potential effects that may occur from project-related activities and corresponding mitigation or monitoring measures would be satisfied through the evaluation of the PDE's maximum design scenario. It should be noted, however, that even if a PDE is applied to support environmental review and permitting, in accordance with 30 CFR §§ 585.700(1) and (2), both a detailed Facility Design Report (FDR) and Fabrication and Installation Report (FIR) must be submitted to BOEM. Furthermore, these reports must be reviewed by the Project Certified Verification Agent (CVA) prior to submission to BOEM.

A summary of PDE parameters for the Project is provided below in Table 1.2-1. Section 3.0 of this COP fully describes the PDE of the Project. The PDE for the Project is based on an operating capacity ranging between 880 megawatts (MW) and 1,300 MW.

CONSTRUCTION AND OPERATIONS PLAN

Introduction – Project Design Envelope

Table 1.2-1 Summary of PDE Parameters

SRWF	Foundations
	<ul style="list-style-type: none"> • Monopile or piled jacket foundations • Up to 123 foundations for WTGs and OCS–DC • Maximum embedment depth of up to 164 feet (ft)(50 meters [m]) for WTG monopile foundations, and 295 ft (90 m) for OCS–DC piled jacket foundation • Maximum area of scour protection and CPS stabilization: 0.70 acres (ac) (2,854 m²) for WTG monopile foundations and 2.66 ac (10,780 m²) for the OCS–DC foundation structure.
	WTG
	<ul style="list-style-type: none"> • Up to 122 WTGs • Nameplate capacity ranging from 8 to 15 MW • Rotor diameter between 538 ft (164 m) and 787 ft (240 m) • Hub height between 367 ft (112 m) and 574 ft (175 m) above mean sea level (AMSL) • Upper blade tip height up to 636 ft (194 m) and 968 ft (295 m) AMSL
	IAC
	<ul style="list-style-type: none"> • Maximum 161 kilovolt AC cables buried up to a target depth of 3 to 7 ft (1 to 2 m) • Maximum total length of up to 186 mi (300 km) • Maximum cable diameter of 8 inches (in; 200 millimeters [mm]) • Maximum disturbance corridor width of 98 ft (30 m) per circuit
	OCS DC
	<ul style="list-style-type: none"> • One OCS–DC • Up to 361 ft (110.0 m) total structure height from lowest astronomical tide (LAT) (including lightning protection and ancillary structures)
SRWEC OCS and SRWEC NYS	SRWEC
	<ul style="list-style-type: none"> • One 320-kV DC export cable bundle buried to a target depth of 3 to 7 ft (1 to 2 m) • Maximum total corridor length of up to 106 mi (170 km) • Maximum individual cable diameter of 7.8 in (200 mm) • Maximum disturbance corridor width of 98 ft (30 m) • Maximum seafloor disturbance for horizontal directional drilling (HDD) exit pits of 61.8 ac (25 ha) • Maximum disturbance for Landfall Work Area (onshore) of up to 6.5 ac (2.6 ha)
Onshore Facilities	Onshore Transmission Cable and Onshore Interconnection Cable
	<ul style="list-style-type: none"> • Onshore Transmission Cable, including associated TJBs and fiber optic cable, up to 17.5 mi (28.2 km) long, with a temporary disturbance corridor of 30 ft (9.1 m) and maximum duct bank target burial depth of 6 ft (1.8 m) • Maximum cable diameter of 6 in (152 mm) • Onshore Interconnection Cable to connect to Holbrook Substation
	OnCS DC
	<ul style="list-style-type: none"> • An OnCS–DC with operational footprint of up to 6 ac (2.4 ha).

CONSTRUCTION AND OPERATIONS PLAN

Introduction – Project Purpose

1.3 Project Purpose

The Project will provide clean, reliable offshore wind energy that will increase the amount and availability of renewable energy to New York while creating the opportunity to displace electricity generated by fossil fuel-powered plants and offering substantial economic and environmental benefits. New York has adopted substantial renewable portfolio standards and clean energy targets to address issues associated with climate change, highlighting the current and future demand for this Project.

In 2014, New York State launched Reforming the Energy Vision (REV), a comprehensive energy strategy that strives to make energy more affordable, build a more resilient energy system, improve existing initiatives and infrastructure, create jobs and business opportunities and protect the environment. Further, REV is focused on building an integrated energy network able to harness the combined benefits of the central grid with clean, locally generated power.

In 2015, New York adopted the 2015 New York State Energy Plan (NYSEP) serving as a roadmap to advance the REV agenda. Among other clean energy goals, the NYSEP set forth the State's long-term goal to provide 50 percent of its electricity from renewable resources by 2030 (the "50 by 30" goal)⁴. The NYSEP included an offshore wind initiative to encourage long-term and strategic regulatory coordination for large-scale offshore wind projects, resulting in the New York State Public Service Commission's (NYSPSC) issuance of an order to implement the Clean Energy Standards (CES or CES Order)⁵. The CES Order requested NYSERDA to lead a research, analysis, and outreach program to evaluate the potential for offshore wind energy in the State resulting in the Offshore Wind Master Plan⁶, and a report titled "Offshore Wind Policy Options" paper (Options Paper) that served as a roadmap for meeting the State's goal of 2,400 MW of offshore energy generation by 2030.

As a result of the Options Paper, and following the completion of a Generic Environmental Impact Statement (GEIS)⁷, in 2018 the NYSPSC issued an Order Adopting the Offshore Wind Standard⁸ setting the stage for the first phase of procurements for offshore wind.

⁴ New York State Energy Planning Board. 2015. "New York State Energy Plan. Volume 1: The Energy to Lead." Accessed June 25, 2020. <https://energyplan.ny.gov/Plans/2015>.

⁵ Proceeding on Motion of the Commission to Implement a Large-Scale Renewable Program and a Clean Energy Standard, Case 15-E-0302, "Order Adopting a Clean Energy Standard", issued and effective August 1, 2016. <http://documents.dps.ny.gov/public/Common/ViewDoc.aspx?DocRefId={44C5D5B8-14C3-4F32-8399-F5487D6D8FE8}>

⁶ Additional information on the Offshore Wind Master Plan can be found at: <https://www.nyserda.ny.gov/All-Programs/Programs/Offshore-Wind/About-Offshore-Wind/Master-Plan>

⁷ In the Matter of Offshore Wind Energy, Case 18-E-0071 <http://documents.dps.ny.gov/public/MatterManagement/CaseMaster.aspx?MatterCaseNo=18-E-0071&submit=Search>

⁸ Order Establishing Offshore Wind Standard and Framework for Phase 1 Procurement. In the Matter of Offshore Wind Energy, Case 18-E-0071 <http://documents.dps.ny.gov/public/Common/ViewDoc.aspx?DocRefId={37EE76DF-81B1-47D4-B10A-73E21ABA1549}>

CONSTRUCTION AND OPERATIONS PLAN

Introduction – Project Purpose

In response to the expressed need and demand, Sunrise Wind executed a contract with NYSERDA for a 25-year OREC Agreement in October 2019. Under the OREC Agreement, NYSERDA will purchase ORECs for 880 MW of offshore wind energy, with the ability to increase by 5 percent without requiring an amendment (totaling up to 924 MW), generated by the operational Project and make them available for purchase by New York load-serving entities. The Project is being developed to fulfill its obligations to New York in accordance with its OREC Agreement. As specified in the OREC Agreement, the Project will generate electricity from an offshore wind farm located in the Lease Area for transmission and delivery to the LIPA Holbrook Substation. The Project will include up to 122 WTG, IAC, one OCS-DC, and one direct current SRWEC making landfall in the Town of Brookhaven, New York.

In addition to the 924 MW contracted to NYSERDA, Sunrise Wind has the opportunity to enter into other potential offtake agreements or sell additional electricity on a merchant basis without an offtake contract. Sunrise Wind is currently working with suppliers to determine the maximum capacity of the DC transmission system, and with the New York Independent System Operator to confirm the maximum interconnection capacity limits at the Holbrook Substation. Depending on the technical limitations of the DC transmission system, as well as the technical limitations for injecting power at the Holbrook Substation, the total nameplate capacity of the Project, inclusive of the 924 MW contracted to NYSERDA, could be up to 1,300 MW. Thus, the PDE for the Project described in Section 1.2 and Section 3 is based on an operating capacity ranging between 880 MW and 1,300 MW. If additional offtake contracts are signed or a decision is made to sell on a merchant basis, the additional capacity (up to 376 MW) would be installed during a single campaign with the 924 MW contracted to NYSERDA.

As such, the Project will help the State achieve the aggressive clean energy goals set forth in REV, the CES and more recently, the *Climate Leadership and Community Protection Act* (CLCPA), which was signed in July 2019 and adopts the most ambitious and comprehensive climate and clean energy legislation in the country. The CLCPA sets forth an ambitious plan that sets the NYS goal of achieving 100 percent carbon-free electricity by 2040 and 70 percent of electricity from renewable sources by 2030, including a target of reaching 9,000 MW of offshore wind by 2035.

CONSTRUCTION AND OPERATIONS PLAN

Introduction – Regulatory Framework

1.4 Regulatory Framework

Project components will be located in three areas: federal waters of the OCS, state waters of New York, and onshore in the Town of Brookhaven, New York. As such, several federal, state, and local regulatory agencies have jurisdictional authority over the Project. The federal, state, and local permits, approvals, and consultations applicable to the Project are listed in Table 1.4-1, along with the date of anticipated issuance. These are described further in the subsections that follow. A summary of consultations to-date with federal, state, and local agencies is provided in Appendix A – *Agency Correspondence* and a summary of strategies for fisheries communications is provided in Appendix B – *Fisheries Communication and Outreach Plan*.

Sunrise Wind was granted coverage under the “FAST-41” framework for improving the federal review and authorization of large-scale infrastructure projects on September 17, 2020. The purpose of Title 41 of Fixing America’s *Surface Transportation Act* (42 United States Code [USC] § 4,370 *et seq.*), known as FAST-41, is to “enhance timeliness, coordination, transparency, predictability and oversight of the federal reviews and permitting required prior to construction.” BOEM is one of 17 government agencies that have been identified as cooperating agencies under FAST-41 to conduct project reviews concurrently, rather than sequentially, in order to streamline the permitting process.

CONSTRUCTION AND OPERATIONS PLAN

Introduction – Regulatory Framework

Table 1.4-1 Summary of Permits, Approvals, and Consultations

Regulatory Authority	Permit/Approval	Statute/Regulation	Anticipated Approval Date
FEDERAL PERMITS, APPROVALS, AND CONSULTATIONS			
BOEM	Issuance of Commercial Lease of Submerged Lands for Renewable Energy Development on the OCS	30 CFR § 585; <i>Outer Continental Shelf Act</i> (43 USC §§ 1331 et seq.)	OCS-A-0487 Lease effective on October 1, 2013, Amended on March 15, 2021
	Approval of Site Assessment Plan	30 CFR §§ 585.610-618	TBD
	Approval of Construction and Operations Plan	30 CFR §§ 585.621-627	Anticipated Q2/Q3 2023
	Consultation with National Oceanic and Atmospheric Administration National Marine Fisheries Service (NOAA Fisheries) [(previously National Marine Fisheries Service [NMFS]) and United States Fish and Wildlife Service (USFWS)	Section 7 of the <i>Endangered Species Act</i> (ESA) (16 USC §§1531 et seq.)	
	Consultation with NOAA Fisheries	<i>Magnuson-Stevens Fishery Conservation and Management Act</i> (MSFCMA) (16 USC §§1801 et seq.), <i>Marine Mammal Protection Act</i> (50 CFR § 216, 16 USC §§ 1361 et seq.)	
	Consultation with USFWS	<i>Migratory Bird Treaty Act</i> (MBTA) (16 USC §§ 703 et seq.) and <i>Bald and Golden Eagle Protection Act</i> (16 USC §§ 668 et seq.)	
	Review under <i>National Environmental Policy Act</i> (NEPA) in consultation with the USACE, National Park Service (NPS) and other cooperating agencies	42 USC §§ 4321 et seq.), BOEM regulations (30 CFR §§ 585.646,585. 648(b)), and other relevant regulations	
	Review under Section 106 in consultation with Advisory Council on Historic Preservation, State Historic Preservation Offices (SHPO), and Tribal Historic Preservation Offices (THPO)	Section 106 of the <i>National Historic Preservation Act</i> of 1966, as amended (54 USC § 306.108)	
	Approval of Facility Design Report	30 CFR §§ 585.538.701	
	Approval of Fabrication and Installation Report	30 CFR § 585.700	
USACE	Issuance of Individual Permit	Section 404, <i>Clean Water Act</i> (CWA; 33 USC § 1344), Section 10, <i>Rivers and Harbors Act</i> (33 USC §§ 333, 403) and Section 14, <i>Rivers and Harbors Act</i> (33 USC § 408)	Anticipated Q2/Q3 2023

CONSTRUCTION AND OPERATIONS PLAN

Introduction – Regulatory Framework

Regulatory Authority	Permit/Approval	Statute/Regulation	Anticipated Approval Date
United States Environmental Protection Agency (EPA)	Issuance of OCS Air Permit and Conformity Determination	<i>Clean Air Act</i> (40 CFR § 55, 60; 42 USC § 7627)	Anticipated Q2/Q3 2023
	Issuance of National Pollutant Discharge Elimination System (NPDES) Individual Permit	<i>Clean Water Act</i> (Section 316(b), 40 CFR § 122, 33 USC § 1251)	Anticipated Q2/Q3 2023
NOAA	Approval of Letter of Authorization (LOA)	<i>Marine Mammal Protection Act</i> (50 CFR § 216, 16 USC §§ 1361 et seq.)	Anticipated Q2/Q3 2023
US Coast Guard (USCG)	Approval for Private Aids to Navigation	USCG regulations (33 CFR § 64.11)	Issued four weeks prior to start of offshore construction
	Local Notice to Mariners		Issued two weeks prior to start of vessel mobilization for offshore construction
NPS	Right-of-Way (ROW) Permit and Temporary Construction Permit	36 CFR § 14 (54 USC § 100902)	Anticipated Q2/Q3 2023
Federal Aviation Administration	Notice of Proposed Construction or Alteration	14 CFR Part 77.0	Anticipated Q3 2022
STATE PERMITS, APPROVALS, AND CONSULTATIONS			
New York State			
NYSPSC, New York State Department of Public Service	Certificate of Environmental Compatibility and Public Need	Article VII of the New York Public Service Law (PSL; 16 New York Codes, Rules and Regulations [NYCRR] Parts 85 through 88), New York Environmental Conservation Law (NYECL) Article 15, Article 24, and Article 25	Anticipated Q3 2022
	Water Quality Certification	Section 401 of the CWA and Implementing Regulations (6 NYCRR Parts 701, 702, 704, 754 and Part 800 to 941)	
	Consultation with New York State Department of Environmental Conservation	Protection of Waters Permit (Article 15 (6 NYCRR Part 608 and 621); Freshwater Wetlands Permit (Article 24, Parts 663 to 665); Tidal Wetlands Permit (Article 25 (6 NYCRR Part 661))	
		Threatened and endangered species (NYECL Article 11 Section 535; 6 NYCRR Part 182)	

CONSTRUCTION AND OPERATIONS PLAN

Introduction – Regulatory Framework

Regulatory Authority	Permit/Approval	Statute/Regulation	Anticipated Approval Date
NYSPPSC, New York State Department of Public Service (cont'd)	Consultation with New York State Office of Parks, Recreation and Historic Preservation, State Historic Preservation Offices (NYSHPPO)	Section 106 of the <i>National Historic Preservation Act</i> , Section 14.09 of the New York State <i>Historic Preservation Act</i> of 1980, and Section 233 of the State Education Law (submerged archaeological resources)	
	Consultation with New York State Department of Agriculture and Markets	Article 25-AA of the Agriculture and Markets Law of 1994	
	Section 68 Petition, Permission to exercise grants of municipal rights	Article VII (Section 68(1))	Anticipated Q3 2022
	Environmental Management and Construction Plan	Article VII (16 NYCRR Parts 85 through 88)	Anticipated Q1 2023
New York State Department of Environmental Conservation (NYSDEC)	State Pollutant Discharge Elimination System (SPDES) General Permit for Stormwater Discharges from Construction Activity	GP-0-20-001 for Stormwater Discharges from Construction Activity, pursuant to 6 NYCRR Part 750-757	Anticipated Q1 2023
New York State Department of Transportation (NYSDOT) – Region 10	Utility or Highway Work Permit	New York State Highway Law (Article 3, Subsection 52, 17 NYCRR Part 131) and 23 CFR Part 645	Anticipated Q1 2023
New York State Office of General Services (NYSOGS), Bureau of Land Management	Easement to Use New York State Lands Under Water	New York State Public Lands Law (Article 2, Section 3, Subsection 2)	Anticipated Q2/Q3 2023
New York State Department of State (NYSDOS), Division of Coastal Resources	Concurrence with Coastal Zone Management Program (CZMP) Federal Consistency Certification	<i>Coastal Zone Management Act (CZMA)</i> (16 USC 1451 et seq., 15 CFR Part 930, and 30 CFR 585.611 (b), 627(b)) and State Article 42 of the Executive Law (19 NYCRR Part 600 and 6 NYCRR Part 617)	Anticipated Q1 2022

CONSTRUCTION AND OPERATIONS PLAN

Introduction – Regulatory Framework

Regulatory Authority	Permit/Approval	Statute/Regulation	Anticipated Approval Date
Rhode Island			
Rhode Island Coastal Resources Management Council (RI CRMC)	Concurrence with CZMP Federal Consistency Determination	CZMA (16 USC §§ 1451 et seq., 15 CFR § 930, and 30 CFR §§ 585.611(b), 627(b)) and Rhode Island Coastal Resources Management Program (RI CRMP) (Section 400)	Anticipated Q1 2022
Massachusetts			
Massachusetts Coastal Zone Management (MACZM)	Concurrence with CZMP Federal Consistency Determination	Pursuant to CZMA (16 USC §§ 1451 et seq, 15 CFR § 930, and 30 CFR §§ 585.611(b), 627(b)), Massachusetts General Law (M.G.L.) (21A, Subpart 4A) and Massachusetts CZMP Policies (310 Code of Massachusetts Regulations [CMR] 20.00 and 21.00)	Anticipated Q1 2022

CONSTRUCTION AND OPERATIONS PLAN

Introduction – Regulatory Framework

1.4.1 BOEM-Led Permits and Approvals

BOEM has the authority and responsibility to regulate activities associated with the production, transportation, or transmission of renewable energy resources on the OCS under the *Outer Continental Shelf Lands Act (OCS Lands Act)* (43 USC § 1337). BOEM must ensure that any approved activities are safe, conserve natural resources on the OCS, are undertaken in coordination with relevant federal agencies, provide a fair return to the US, and are compliant with all applicable laws and regulations (30 CFR § 585.102), including the *National Environmental Policy Act (NEPA)*.

BOEM issued Renewable Energy Lease Area OCS-A 0487 to Sunrise Wind for development of a renewable energy project(s) within the Lease Area. The construction and O&M of the Project will require a COP that is compliant with BOEM regulations (30 CFR § 585) and that is approved by BOEM prior to the start of construction. With approval of this COP, Sunrise Wind requests that BOEM issue a project easement for the portions of the SRWEC located in federal waters (i.e., SRWEC–OCS).

BOEM is expected to coordinate with agencies such as the National Oceanic and Atmospheric Administration (NOAA), US Fish and Wildlife Service (USFWS), National Park Service (NPS), US Coast Guard (USCG), the US Department of Defense (DoD), US Department of Transportation's Federal Aviation Administration (FAA), and the US Bureau of Safety and Environmental Enforcement (BSEE) to complete necessary project reviews. In addition, federal agency review of the Project must also occur under NEPA, Section 106 of the *National Historic Preservation Act (NHPA)*, and Section 307 of the *Coastal Zone Management Act (CZMA)*, which requires concurrence from New York State, Rhode Island, and Massachusetts for the Coastal Zone Management Program (CZMP) federal consistency determination for each state, as described below.

1.4.1.1 *National Environmental Policy Act*

The NEPA (42 USC § 4321 et seq.) requires federal agencies to evaluate the potential impacts of any proposed federal action and to consider alternatives to the proposed action (42 USC § 4332, 40 CFR §§ 1500-1508). There are several federal actions associated with the Project that require review under NEPA including but not limited to: BOEM's approval of the COP; USACE issuance of an Individual Permit; NPS issuance of a right-of-way (ROW) Permit within Fire Island National Seashore; and NOAA issuance of a Letter of Authorization (LOA). For renewable energy facilities on the OCS, BOEM acts as the Lead Federal Agency for NEPA review and compliance.

BOEM will lead the preparation of an Environmental Impact Statement (EIS) to evaluate potential impacts associated with implementation of the Project (40 CFR § 1501.7[g]). Federal agencies, identified as cooperating agencies in the NEPA process, are responsible for reviewing the Project's impacts to protected resources under their jurisdiction and evaluating the need for mitigation measures. These agencies will have the opportunity to comment through interagency consultations required for federal permitting (NEPA, USACE Individual Permit Application). In addition, BOEM will be required to satisfy Section 106 of the NHPA, which requires consideration of historic properties.

CONSTRUCTION AND OPERATIONS PLAN

Introduction – Regulatory Framework

1.4.1.2 *Endangered Species Act*

Section 7 of the *Endangered Species Act* (ESA) requires that federal agencies ensure their actions do not destroy or jeopardize the existence of critical habitat of any threatened or endangered species listed under the ESA. To comply with this obligation, BOEM is required to consult with USFWS and NOAA Fisheries.

USFWS and NOAA Fisheries would be responsible for reviewing Project impacts to protected resources and evaluating the need for mitigation measures. These agencies will have the opportunity to comment through interagency consultations required for federal permitting. USFWS and NOAA Fisheries will review impacts to marine, coastal, and terrestrial threatened and endangered species protected by the ESA.

If construction or O&M is likely to adversely impact listed species under USFWS jurisdiction (such as terrestrial animal or plant species or avian species), or under NOAA Fisheries jurisdiction (such as fish species), then an Incidental Take Authorization may be required from USFWS or NOAA Fisheries under the ESA. In addition, NOAA Fisheries may be required to issue an LOA pursuant to the *Marine Mammal Protection Act* (MMPA) (described further in Section 1.4.2)

Impacts to non-listed species and habitats will also be evaluated under several other wildlife protection laws, including the *Migratory Bird Treaty Act* (MBTA) of 1918, the *Bald and Golden Eagle Protection Act* of 1940, the MMPA, and the *Magnuson-Stevens Fishery Conservation and Management Act* (MSFCMA) of 1976 as amended.

1.4.1.3 *National Historic Preservation Act*

Section 106 of the NHPA, as amended (54 USC § 306108) requires that federal agencies consider the effect of the undertaking on any district, site, building, structure, or object that is included in or eligible for inclusion in the National Register of Historic Places (NRHP). To comply with this obligation, BOEM is required to consult with the applicable State Historic Preservation Offices (SHPOs), Native American tribes commonly represented by Tribal Historic Preservation Offices (THPOs), and other interested parties.

1.4.1.4 *Coastal Zone Management Act*

The CZMA requires that federal actions impacting any coastal use or resource (defined as land or water use, or natural resource of a state's coastal zone), be conducted in a manner that is consistent with the enforceable policies of a state's federally approved CZMP or CRMP. Within this authority of the CZMA, state coastal programs that have been approved by NOAA may review federal actions impacting their coastal uses or resources or both, to verify that such activities are consistent with the state's enforceable program policies.

Sunrise Wind has prepared consistency certifications for review by New York, Rhode Island, and Massachusetts to confirm consistency with each state's enforceable policies impacting any coastal use or resource. In accordance with the "consistency" requirement of the CZMA (16 USC § 1456 as well as 307(c)(3)(A), and 15 CFR Part 930 §§ D and E), Appendix C – *Coastal Zone Management Consistency Certifications* presents a tabular summary of applicable enforceable policies under the CZMP or CRMP for these states and an evaluation of how the Project will be consistent with each policy, as well as cross references to specific sections of the COP where the policy is addressed.

CONSTRUCTION AND OPERATIONS PLAN

Introduction – Regulatory Framework

1.4.2 Other Federal Permits, Approvals, and Consultations

In addition to the approvals led by BOEM, the Project will also require other federal approvals. These include an Individual Permit and Letter of Authorization from USACE; OCS Air Permit and NPDES Individual Permit from the US Environmental Protection Agency (EPA); LOA from NOAA Fisheries; Private Aids to Navigation Permits (PATON[s]) and Local Notice to Mariners from the USCG; ROW Permit and Temporary Construction Permit from NPS; Notice of Proposed Construction or Alteration from the FAA; and an Analysis of Potential Military and Naval Impacts from the DoD.

1.4.2.1 USACE - Individual Permit and Section 408 Letter of Authorization

USACE has jurisdiction over the Project pursuant to Section 10 and Section 14 of the *Rivers and Harbors Appropriation Act of 1899* (RHA), and Section 404 of the *Clean Water Act* (CWA) due to the Project's location within navigable waters, federally maintained navigation channels, and Waters of the United States.⁹ Sunrise Wind will apply for an Individual Permit from USACE Region 2 for the planned activities. The Individual Permit process includes an application sufficiency review, as well as review of proposed Project impacts on the environment, public notice, and a public hearing, which will be conducted in coordination with BOEM's review of the COP.

Section 404 of the CWA (33 USC § 1344) establishes federal regulatory authority over the discharge of dredged or fill material into Waters of the United States, including wetlands. These activities may include side-casting of material during installation of the SRWEC–NYS, temporary excavation of material associated with construction activities at the landfill, placement of concrete matting associated with cable protection along the SRWEC–NYS, and any temporary or permanent fill associated with the Onshore Facilities.

Section 10 of the RHA (33 USC § 403) requires authorization from the USACE for the construction of any structure in or over any navigable water of the United States, as well as fixed structures on the OCS. This includes installation of foundations on the OCS, as well as installation of the SRWEC–OCS and SRWEC–NYS under the seafloor. USACE Section 10 review of the Project will occur concurrently with the Section 404 review.

Section 14 of the RHA (33 USC § 408) ensures that congressionally-authorized benefits of a project are protected and maintained (e.g., flood risk management, coastal storm damage reduction, navigation) and to ensure the proposed alteration is not injurious to the public interest. Section 408 of the RHA allows USACE to grant permission for another party to alter a Civil Works¹⁰ project constructed by the USACE, assuming such alteration will not be injurious to the public interest and will not impair the usefulness of the Civil Works project. The USACE will issue a Letter of Authorization for projects authorized under Section 408 of the RHA. This includes crossing of the Long Island Intracoastal Waterway (ICW), the Fire Island to Montauk Point Reformulation Study, and the Fire Island Inlet to Moriches Inlet Stabilization Project.

⁹ Waters of the United States are defined in 40 CFR 230.3(s)

¹⁰ The USACE Civil Works programs include water resource development projects, including flood risk management, navigation, recreation, and infrastructure and environmental stewardship, as well as emergency response.

CONSTRUCTION AND OPERATIONS PLAN

Introduction – Regulatory Framework

The USACE New York District will be a cooperating agency under BOEM's NEPA process to satisfy the NEPA requirements for these authorizations. USACE reviews under RHA Section 10 and 14, and CWA Section 404 will be processed concurrently with BOEM's NEPA review and USACE approval would be issued following conclusion of BOEM-led NEPA review.

1.4.2.2 EPA - Outer Continental Shelf Air Permit

The EPA regulates air quality on the OCS pursuant to the *Clean Air Act (CAA) Outer Continental Shelf Air Act* (42 USC § 7627; 40 CFR Part 55, 60), including emissions from the construction, O&M, and decommissioning of the Project, including any equipment, activity, or facility that emits, or has the potential to emit, any air pollutant; is regulated or authorized under the *OCS Lands Act*; and is located on the OCS, or in or on waters above the OCS. This definition includes vessels when they are permanently or temporarily attached to the seabed (40 CFR 55.2), as well as vessels associated with the Project while operating at the SRWF or within 25 mi (40.2 km) of the activity. Due to the location of the Project, it is possible that both Massachusetts and New York will be designated as the Corresponding Onshore Areas (COAs).

Additionally, activities located in state territorial waters and within state nonattainment areas for National Ambient Air Quality Standards (NAAQS) may require a General Conformity determination, as specified in 40 CFR §93, Subpart B, to demonstrate that the activity will not interfere with the state implementation plan for air quality control and will not cause or contribute to new violations, and to support attainment and maintenance of the NAAQS.

1.4.2.3 EPA - National Pollutant Discharge Elimination System (NPDES) Individual Permit

The EPA regulates point sources that discharge pollutants to waters of the United States pursuant to the CWA (Section 316(b), 40 CFR § 122, 125, 33 USC § 1251). New York State has partially delegated authority within state jurisdiction (discussed in 1.4.3) and the EPA retains authority over point sources on the OCS.

The OCS-DC is located in federal waters and therefore does not fall within any specific state's jurisdiction. Coordination thus far with the EPA indicates that issuance of the individual NPDES permit for operation of the OCS-DC will be administered through EPA Region 1. Consistent with the description provided in §125.81, the OCS-DC is a new facility that is considered a point source, has a cooling water intake system (CWIS) that uses at least 25 percent of the water withdrawn for cooling, has a design intake flow (DIF) and discharge volume of approximately 8.1 million gallons per day, and is thus subject to the Track I requirements for new facilities defined at §125.84(b) as it pertains to Section 316(b) of the CWA.

1.4.2.4 NOAA Fisheries - Letter of Authorization

Pursuant to the MMPA (16 USC § 1361 et seq.), certain species and population stocks of marine mammals that are, or may be, in danger of extinction or depletion as a result of man's activities should be protected and encouraged to develop to the greatest extent feasible commensurate with sound policies of resource management and the primary objective of their management should be to maintain the health and stability of the marine ecosystem.

CONSTRUCTION AND OPERATIONS PLAN

Introduction – Regulatory Framework

The MMPA designated NOAA Fisheries (previously known as the National Marine Fisheries Service [NMFS]) as the primary agency responsible for the protection of whales, dolphins, porpoises, seals, and sea lions.

Construction and O&M of the Project requires consultation with NOAA Fisheries and will likely require authorization from NOAA Fisheries for the unintentional “take” of marine mammals incidental to certain noise producing activities associated with the Project, including pile driving.

1.4.2.5 USCG - Private Aids to Navigation Permit and Local Notice to Mariners

The USCG exercises authority over maritime navigation in Waters of the United States pursuant to 33 CFR § 66 (49 USC § 44718). PATON includes all marine aids to navigation operated in the navigable Waters of the United States other than those operated by the Federal Government or those operated in State waters for private aids to navigation.

The USCG will issue a PATON approval for installation of the WTGs and OCS–DC to alert mariners to potential hazards to navigation. The PATON approval will be obtained after receipt of the USACE permit, approximately four weeks prior to the start of offshore construction.

A request for a Local Notice to Mariners (LNM) will be submitted to the USCG prior to vessel mobilization for construction activities to enable USCG to issue the LNM. An LNM is a weekly notification published by the USCG to disseminate information to mariners concerning aids to navigation, hazards to navigation, and other items of interest to marine users.

1.4.2.6 NPS - Right-of-Way Permit and Temporary Construction Permit

NPS exercises authority over public lands included in the National Park System. While Smith County Park is not owned by the federal government, it is designated within the Fire Island National Seashore, and portions of the SRWEC–NYS and Onshore Transmission Cable will be located under the seafloor within the Fire Island National Seashore. As such, the Secretary of the NPS must grant a ROW Permit pursuant to 54 USC § 100902, and may also issue a temporary construction permit.

1.4.2.7 Federal Aviation Administration (FAA) - Notice of Proposed Construction or Alteration

The FAA has jurisdiction to review and certify that structures greater than 199 ft (61 m) above ground level do not have adverse effects on the safety or efficient utilization of navigable airspace within 13.8 mi (12 nm; 22 km) of the shoreline (49 USC § 44718 and 14 CFR Part 77). Beyond this distance, BOEM assumes responsibility for review. Under 14 CFR Part 77.9, a Notice of Proposed Construction or Alternative is required to be filed with the FAA for the construction or alteration of structures that exceed the criteria set forth in 14 CFR Part 77.9, or if otherwise requested by the FAA, including construction cranes, to ensure activities will not impact air navigation or airport operations.

During final design and construction, Sunrise Wind will apply the Part 77.9 criteria to the OnCS–DC and, if required, will submit notice to the FAA to determine if the proposed structures and construction activities will impact air navigation. If the FAA requires, the final design and construction of the new structures will incorporate appropriate mitigation measures (e.g., lighting and/or marking).

CONSTRUCTION AND OPERATIONS PLAN

Introduction – Regulatory Framework

1.4.2.8 Department of Defense (DoD) - Analysis of Potential Military and Naval Impacts

Structures that fall under BOEM jurisdiction must also be reviewed by the DoD and the Department of Homeland Security to identify any potential interference with operations and/or radar systems. The SRWF is more than 13.8 mi (12 nm; 22 km) from shore and, therefore, is not subject to FAA review, but is subject to review by BOEM, DoD, and the Department of Homeland Security.

The Office of the Assistant Secretary of Defense for Energy, Installations, and Environment, US DoD Military Aviation and Installation Assurance Siting Clearinghouse will provide an analysis of potential Project impacts to military operations (e.g., military testing and training operations and military radar capabilities) and the US Naval Seafloor Cable Protection Office would provide recommendations to avoid the Navy's submarine assets, including cable systems.

1.4.3 State Permits, Approvals, and Consultations

The NYSPSC will lead the review of the SRWEC–NYS and Onshore Facilities within the territory of the State of New York under Article VII of the New York PSL, which will include review under Section 401 of the CWA.

The SRWEC has a design capacity that exceeds 125 kV and extends more than 1 mi (0.87 nm, 1.6 km); therefore, it is considered an electric transmission facility (16 New York Codes, Rules and Regulations [NYCRR] Subpart 85-2.1). As such, the portion of the SRWEC in New York State territorial waters (3 mi [2.6 nm, 4.8 km] offshore) to its onshore interconnection point with the LIPA transmission system (SRWEC–NYS and Onshore Facilities) is subject to review and approval by the NYSPSC under Article VII of the New York PSL (16 NYCRR Parts 85 through 88), which authorizes the Siting of Major Utility Transmission Facilities.

The Article VII process provides a full review of the need for and environmental impact of the siting, design, construction, and operation of the SRWEC–NYS and Onshore Facilities and results in the issuance of a Certificate of Environmental Compatibility and Public Need (CECPN). The CECPN will include Water Quality Certification, pursuant to Section 401 of the CWA and Implementing Regulations (6 NYCRR Parts 701, 702, 704, 754 and Part 800 to 941); issuance of Protection of Waters Permit, pursuant to New York Environmental Conservation Law (NYECL) Article 15 (6 NYCRR Part 608 and 621), Freshwater Wetlands Permit, pursuant to NYECL Article 24 (6 NYCRR Part 663 – 665), Tidal Wetlands Permit, pursuant to NYECL Article 25 (6 NYCRR Part 661); and review under Section 68 of the New York PSL.

Prior to construction, the NYSPSC must also approve an Environmental Management and Construction Plan (EM&CP) that describes the practices during construction that will demonstrate compliance with the CECPN.

In addition, prior to the start of construction, Sunrise Wind will apply for coverage under the SPDES General Permit for Stormwater Discharges from Construction Activity from New York State Department of Environmental Conservation (NYSDDEC), a Utility Work Permit and Highway Work Permit from New York State Department of Transportation (NYSDOT), and an Easement to Use New York State Lands Under Water from New York State Office of General Services (NYSOGS), Bureau of Land Management, as described further below.

CONSTRUCTION AND OPERATIONS PLAN

Introduction – Regulatory Framework

Consultation and review will also occur with NYSDEC for state-listed threatened and endangered species and unique or significant habitats; New York State Office of Parks, Recreation and Historic Preservation (NYSOPRHP) for cultural and historic resources; and New York State Department of Agriculture and Markets (NYSDAM) for agricultural lands.

1.4.3.1 NYSDEC - SPDES General Permit

Under the Federal CWA as implemented by New York State under NYECL Article 17, stormwater discharge(s) from construction activities that disturb one acre or more are required to be covered under the SPDES General Permit for Stormwater Discharges from Construction Activities (GP-0-20-001) or its successor issued by the NYSDEC. Because construction activities for the Project will result in soil disturbance exceeding the one-acre threshold, a Notice of Intent will be submitted to the NYSDEC seeking coverage under the General Permit prior to commencement of Project construction.

One of the requirements of the SPDES Permit is the development of a Stormwater Pollution Prevention Plan (SWPPP) in accordance with the requirements set forth in the SPDES Permit. The SWPPP will address stormwater management and temporary soil erosion, identifying site-specific measures to minimize pollution associated with stormwater runoff. In accordance with the General Permit, the Project will be subject to the requirements of a regulated traditional land use control, Municipal Separate Storm Sewers System (MS4), in the Town of Brookhaven. As such, Sunrise Wind will have the SWPPP reviewed and the MS4 SWPPP Acceptance form signed by the Town. The SWPPP will be included in the Project EM&CP.

1.4.3.2 NYSDOT - Utility Work Permit

Any utility work within a state highway ROW requires a highway work permit from the NYSDOT. Sunrise Wind will submit Form PERM 32 (Highway Work Permit Application for Utility) to the NYSDOT Region 10 office prior to construction and obtain highway work permit(s) from the NYSDOT Region 10 pursuant to 17 NYCRR Part 131 for the construction of the Onshore Transmission Cable and the Onshore Interconnection Cable in NYS highway ROWs. Sunrise Wind will also enter into a Use and Occupancy Agreement with NYSDOT, which will provide the conditions for the occupation of the highway ROWs.

1.4.3.3 NYSOGS - Easement for Lands Under Water

Pursuant to the New York Public Lands Law, real estate rights to the bed of numerous bodies of water are held in trust for the people of State of New York under the jurisdiction of the NYSOGS. An easement from NYSOGS is required to install utilities, including submarine cables, below lands that are under waters of state-owned waterbodies.

CONSTRUCTION AND OPERATIONS PLAN

Introduction – Agency and Stakeholder Outreach

1.4.4 Local Permits and Approvals

Sunrise Wind will seek a road use agreement with the Town of Brookhaven, pursuant to PSL § 68. Due to the pre-emptive effect of PSL § 130, the procedural requirements to obtain any local approval, consent, permit, certificate or other condition for the construction and operation of the Project do not apply. As such, in the CECPN Application to the NYSPSC, Sunrise Wind will demonstrate compliance with electric and magnetic field standards for new transmission lines (NYSPSC, 1990) and with the Coastal Erosion Hazard Area Law (Article 34), administered by the Town of Brookhaven. Sunrise Wind has sited the Onshore Facilities to be consistent with the goals of the *Pine Barrens Protection Act* (Article 57), overseen by the Central Pine Barrens Joint Planning and Policy Commission, to the extent practicable. Sunrise Wind has coordinated with, and will continue to coordinate with, the Central Pine Barrens Joint Planning and Policy Commission and will request a Core Preservation Area Hardship Waiver from the Central Pine Barrens Joint Planning and Policy Commission based on compelling public need for the portion of the Onshore Facilities that will traverse the Central Pine Barrens.

1.5 Agency and Stakeholder Outreach

Sunrise Wind has been actively engaged in extensive Project outreach with federal and state agencies, federally and state recognized Native American tribes, and local entities in the Town of Brookhaven, and Suffolk County, New York, which includes stakeholders representing a broad range of perspectives, and the public.

Sunrise Wind is committed to stakeholder communications and public outreach during Project development. A wide and varied range of communication methods will allow stakeholders and the public to be informed about the Project. The public involvement program for the Project includes:

- Regular and ongoing briefings with federal and state agencies, tribes, elected officials, and other stakeholders to provide Project updates, solicit input and concerns, and respond to inquiries;
- Communications and regular and ongoing briefings with commercial and recreational fishing industry;
- Communications and notification of upcoming survey activities with abutting residents; and
- Regular and ongoing outreach and briefings to civic, community, environmental, and business groups, as well as informational meetings for the public to provide Project updates.

A summary of agency, tribal, and stakeholder meetings through June 1, 2021 is provided in Appendix A, and the Fisheries Communications Plan is provided in Appendix B. A summary of engagement with stakeholders other than regulatory agencies and Native American tribes is provided in Table 1.5-1.

CONSTRUCTION AND OPERATIONS PLAN

Introduction – Agency and Stakeholder Outreach

Table 1.5-1 Stakeholder Engagement

Stakeholder	Summary of Engagement
<p>Fishing Communities and Other Mariners are important stakeholders with which the Project strives to achieve “shared use” of the Lease Area.</p>	<ul style="list-style-type: none"> • Established Fisheries Representative (FR) Program focused on working with fisheries organizations to achieve broad engagement within sectors of fishing industry and Fisheries Liaisons focused on direct outreach with fisheries. • Utilized Fishing Industry Representatives (FIRs) onboard survey vessels to promote “real-time” communication with fishermen while on the water and to facilitate positive coexistence with ongoing fishing activity. • Partnered with the Responsible Offshore Development Alliance (RODA) to create and establish opportunities for commercial fishermen to provide direct input to wind energy industry, such as a survey to the commercial fishing industry for preferences related to aids-to-navigation in wind farms. • Implemented port hours and online surveys at several ports in New York and New England to provide opportunity for fishermen and mariners to speak with Fisheries Liaisons regarding Project survey activities and Project questions. • Attended North Atlantic and Mid-Atlantic fisheries management council meetings, Massachusetts Fisheries Working Group and RICRMC Fishermen’s Advisory Board and Habitat Advisory Board (FAB/HAB) meetings. • Participates in NYSERDA Fisheries Technical Working Group (F-TWG) and Mariners Technical Working Group (M-TWG). • Attended fisheries trade events such as boat shows and fishing expos to interface with the recreational community. • Conducted over 100 meetings with fisheries businesses and individual fishermen to collect and implement feedback on layout, schedule, and other Project parameters.
<p>Labor and Local Business Interests can benefit from the Project through job creation, local purchasing of supplies and equipment, and other development and operations support opportunities.</p>	<ul style="list-style-type: none"> • Participated in regular meetings with NYSERDA and held 7 Open Houses in coordination with NYSERDA. • Participated in collaborative discussions on port utilization planning in regular meetings with local ports, port authorities, and related stakeholders in New York and New England. • Participated in supply chain development events engaging directly with local and regional businesses and applicable governmental agencies in New York to explore and promote opportunities in offshore wind supply chain. • Committed to seed funding of \$10M for a national offshore training center in New York; a commitment endorsed by local labor unions • Committed to fund an Upper Hudson Workforce Development Initiative for \$1M. • Committed to developing an O&M Port in New York.

CONSTRUCTION AND OPERATIONS PLAN

Introduction – Agency and Stakeholder Outreach

Stakeholder	Summary of Engagement
<p>Environmental Non-Governmental Organizations (eNGOs) (including but not limited to National Wildlife Federation, Conservation Law Foundation, and the Natural Resources Defense Council, Responsible Offshore Science Alliance) that are interested in the environmental benefits and potential impacts of the Project.</p>	<ul style="list-style-type: none"> • Participated in externally-led initiatives, including the ad-hoc Habitats Working Group, established by MACZM in collaboration with the Massachusetts Clean Energy Center, the American Wind Energy Association's Offshore Committee, and BOEM; • Participated in NYSERDA Environmental Technical Working Group (E-TWG). • Held and attended meetings with environmental organizations to gather input, hear concerns, and share updates regarding Project plans and status. • Attended and supported marine science conferences and workshops. • Sponsor of Whale Alert Network. • Founding member and represented on board of Responsible Offshore Science Alliance (ROSA).
<p>Local Communities have the potential to be impacted by construction and operation of the Project and Sunrise Wind is committed to engaging with these communities to share information and minimize potential disturbance.</p>	<ul style="list-style-type: none"> • Active presence on social media to provide updated information on surveys and other Project activities. • Maintained regular communication with several local and regional entities, including Suffolk County, the Town of Brookhaven, and Port Jefferson Village. • Provided communications to abutters about upcoming fieldwork. • Provided regular updates to state and federal legislators. • Held virtual open house, focused on onshore route, in November 2020, and open house materials available for public review through at least December 31, 2021.
<p>Universities and Institutions can provide a wealth of valuable data and have served as leaders in both science and job training.</p>	<ul style="list-style-type: none"> • Collaborated with several area universities including SUNY Stony Brook, Suffolk County Community College, and the Workforce Development Institute to support workforce development, training, and primary research in offshore-related fields of study. • Participated in forums led by these entities to share Project information and opportunities for additional collaboration. • Committed to funding of \$5M for research initiatives specific to the advancement of offshore wind through Stony Brook University's Advanced Energy Research and Technology Center.

CONSTRUCTION AND OPERATIONS PLAN

Introduction – Other Project Information

1.6 Other Project Information

1.6.1 Authorized Representative and Designated Operator

Sunrise Wind, a 50/50 joint venture between Orsted NA and Eversource, will be the operator of the Project. The contact information for the Authorized Representative for the Project is included in Table 1.6-1.

Table 1.6-1 Authorized Representative and Owner

Required Detail	Contact Information
Name of Authorized Representative	Peter Allen
Title	Director, North East Offshore, LLC Manager of Sunrise Wind LLC
Phone Number	917-596-8202
Email	PEALL@orsted.com
Address	437 Madison Avenue, Suite 1903, New York, NY 10022

Ørsted A/S (corporate parent of Orsted NA) is the global industry leader in offshore wind and has significant experience with the rigors and challenges of the offshore wind business. Over the past 25 years, Ørsted A/S has constructed 5.6 gigawatts (GW) of offshore wind capacity (just under 30 percent of globally installed offshore wind capacity), with an additional 3.4 GW currently under construction. Ørsted A/S's existing activities span a number of markets, including the US, Denmark, the United Kingdom, Germany, the Netherlands, and Taiwan. In 2018, Orsted NA acquired Deepwater Wind LLC, the company that built the United States' first offshore wind farm off Block Island near the Town of New Shoreham, Rhode Island. Orsted NA's legacy Deepwater Wind LLC team gained invaluable experience working with regulators, stakeholders, vendors, and US construction contractors through the development and execution of the Block Island Wind Farm project. Together, Orsted NA's expanded team is leading a stakeholder-centric approach to development up and down the eastern seaboard as we seek to develop offshore wind resources.

Currently, Orsted NA has in its US portfolio commitments for approximately 3 GW of offshore wind serving five states. In connection with the Block Island Wind Farm project, Orsted NA also fully developed the Block Island Transmission System, which includes a 30-mi onshore and offshore transmission system that connected Block Island to the mainland of Rhode Island for the first time. This was the first offshore renewable-energy transmission system constructed in the US.

Eversource is an industry leader in constructing and maintaining large transmission and distribution projects, including high-voltage and extra high-voltage overhead, underground, submarine, and hybrid transmission lines, and associated terminal equipment. Throughout New England and New York, Eversource has successfully completed hundreds of capital projects over the past decade, with a proven track record in successful single state and multi-state project siting and permitting; working closely with other companies to develop major projects; and safely and efficiently constructing transmission and distribution projects. It has successfully completed hundreds of traditional and major capital projects over the past

CONSTRUCTION AND OPERATIONS PLAN

Introduction – Other Project Information

decade, employing innovative solutions to technical and environmental challenges such as: the first and most extensive 345-kV applications of solid core cross-linked polyethylene (XLPE) underground cables in the US; laying marine cable in Long Island Sound from a purpose-built ship; and constructing overhead transmission support structures from the air, using helicopters. Eversource is one of only four North American energy companies certified as an Environmental, Social, and Governance leader, and is recognized as a leader in providing top-tier reliability with the utmost focus on safety.

1.6.2 Certified Verification Agent

Pursuant to 30 CFR § 585.705, a CVA must be engaged to certify to BOEM that the proposed facility is designed to withstand the environmental and functional load conditions for the intended life of a project at its proposed location. In accordance with 30 CFR § 585.706, Sunrise Wind has included a CVA nomination in this COP for BOEM approval. This nomination (inclusive of a nomination statement, statement of qualifications, and scope of work and verification plan) is provided in Appendix D – *Certified Verification Agent*, under confidential cover.

Sunrise Wind will develop individual codes and standards documents for technical areas, including foundations, cables, and WTG. These documents will be reviewed by the CVA prior to submission to BOEM. The CVA will review each document and provide a letter approving the use of standards. Sunrise Wind will provide the codes and standards documents, along with the CVA letters, to BOEM for review and comment.

1.6.3 Emergency Response Plan/Oil Spill Response Plan (ERP/OSRP)

Pursuant to 30 CFR § 585.627(c), an Oil Spill Response Plan (OSRP) must be submitted to the BSEE. In accordance with 30 CFR Part 254, Sunrise Wind has developed and presented Appendix E1 – *Emergency Response Plan/Oil Spill Response Plan*, which is provided under confidential cover.

1.6.4 Safety Management Plan

Pursuant to 30 CFR § 585.627(d), a Safety Management System must be submitted to BOEM. In accordance, with 30 CFR § 585.810, Sunrise Wind has developed and presented this in Appendix E2 – *Safety Management System*, which is provided under confidential cover.

1.6.5 Financial Assurance

Sunrise Wind will provide financial assurance in accordance with 30 CFR § 585.516, prior to BOEM approval of this COP. Orsted and Eversource are stable and diversified, publicly traded energy companies, with a combined market capitalization of approximately \$49 billion, and combined operating cash flows of approximately \$3 billion annually. Orsted is the global leader in financing, constructing, and operating offshore wind, and—as a result of the recent acquisition of Deepwater Wind LLC—its team now includes the individuals responsible for the first ever financing of an offshore wind farm in the US, and the first tax-equity financing of an offshore wind farm anywhere in the world.

CONSTRUCTION AND OPERATIONS PLAN

Introduction – BOEM COP Requirements and Lease Stipulations

1.7 BOEM COP Requirements and Lease Stipulations

Table 1.7-1 BOEM Requirements for Developing a Construction and Operations Plan

BOEM Requirements	Location in COP
30 CFR §585.105(a)	
a) The project will conform to all applicable laws, implementing regulations, lease provisions, and stipulations or conditions of the lease.	<ul style="list-style-type: none"> • Section 1.4. Regulatory Framework
b) The project will be safe.	<ul style="list-style-type: none"> • Appendix B. Fisheries Communication Plan • Appendix G1. Marine Site Investigation Report • Appendix E1. Emergency Response Plan/Oil Spill Response Plan • Appendix E2. Safety Management System • Appendix F. Conceptual Project Engineering Design Drawings/Additional Project Information • Appendix I2. Onshore Acoustic Assessment • Appendix J2. Onshore EMF Assessment • Appendix X. Navigation Safety Risk Assessment • Appendix Y1. Obstruction Evaluation and Air Space Analysis / Radar and Navigational Aid Screening Study • Appendix Y2. Air Traffic Flow Analysis/ADLS Analysis
c) The project will not unreasonably interfere with other uses of the outer continental shelf (OCS), including those involved with National security or defense.	<ul style="list-style-type: none"> • Section 4.7.3. Recreation and Tourism • Section 4.7.4. Commercial and Recreational Fisheries • Section 4.7.5. Other Marine Uses and Coastal Land Use • Section 4.8.1. Marine Transportation and Navigation • Appendix B. Fisheries Communication Plan • Appendix V. Commercial and Recreational Fisheries Data Report • Appendix X. Navigation Safety Risk Assessment
d) The project will not cause undue harm or damage to natural resources; life (including human and wildlife); property; the marine, coastal, or human environment; or sites, structures, or objects of historical or archeological significance.	<ul style="list-style-type: none"> • Table ES-1. Executive Summary • Section 4.0. Site Characterization and Assessment of Impacts • Appendix G1. Marine Site Investigation Report
e) The project will use the best available and safest technology.	<ul style="list-style-type: none"> • Section 3.0. Description of Proposed Activity
f) The project will use best management practices.	<ul style="list-style-type: none"> • Table ES-1. Executive Summary • Section 4.9. Summary of Potential Impacts and Environmental Protection Measures
g) The project will use properly trained personnel.	<ul style="list-style-type: none"> • Appendix E2. Safety Management System
30 CFR § 585.626(a) - You must submit the results of the following surveys for the proposed site(s) of your facility(ies). Your COP must include the following information:	
<p>1) Shallow hazards: The results of the shallow hazards survey with supporting data. Information sufficient to determine the presence of the following features and their likely effects on your proposed facility, including:</p> <ul style="list-style-type: none"> (i) Shallow faults; (ii) Gas seeps or shallow gas; (iii) Slump blocks or slump sediments; (iv) Hydrates; or (v) Ice scour of seabed sediments. 	<ul style="list-style-type: none"> • Appendix G1. Marine Site Investigation Report

CONSTRUCTION AND OPERATIONS PLAN

Introduction – BOEM COP Requirements and Lease Stipulations

BOEM Requirements		Location in COP
2) Geological survey relevant to the design and siting of your facility.	The results of the geological survey with supporting data. Assessment of: 1. Seismic activity at your proposed site; 2. Fault zones; 3. The possibility and effects of seabed subsidence; and 4. The extent and geometry of faulting attenuation effects of geologic conditions near your site.	<ul style="list-style-type: none"> • Section 4.3.2. Geological Conditions • Appendix G1. Marine Site Investigation Report • Appendix H. Sediment Transport Modeling Report
3) Biological: The results of the biological survey with supporting data. A description of the results of biological surveys used to determine the presence of:	Live bottoms and hard bottoms.	<ul style="list-style-type: none"> • Section 4.3.2. Geological Conditions • Section 4.4.2. Benthic and Shellfish Resources • Appendix G1. Marine Site Investigation Report • Appendix M1. Benthic Resources Characterization Report – Federal Waters • Appendix M2. Benthic Resources Characterization Report – New York State Waters • Appendix M3. Benthic Habitat Mapping Report
	Topographic features.	<ul style="list-style-type: none"> • Section 4.3.2. Geological Conditions • Appendix G1. Marine Site Investigation Report
	Surveys of other marine resources such as fish populations (including migratory populations).	<ul style="list-style-type: none"> • Section 4.4.2. Benthic and Shellfish Resources • Section 4.4.3. Finfish and Essential Fish Habitat • Appendix G1. Marine Site Investigation Report • Appendix M1. Benthic Resources Characterization Report – Federal Waters • Appendix M2. Benthic Resources Characterization Report – New York State Waters • Appendix M3. Benthic Habitat Mapping Report • Appendix N. Essential Fish Habitat Assessment
	Marine mammals.	<ul style="list-style-type: none"> • Section 4.4.4. Marine Mammals • Appendix O. Marine Mammal, Sea Turtle, and ESA-Listed Fish Assessment Report
	Sea turtles.	<ul style="list-style-type: none"> • Section 4.4.5. Sea Turtles • Appendix O. Marine Mammal, Sea Turtle, and ESA-Listed Fish Assessment Report
	Sea birds.	<ul style="list-style-type: none"> • Section 4.4.6. Avian Species • Appendix P. Avian and Bat Risk Assessment
4) Geotechnical survey: The results of your sediment testing program with supporting data, the various field and laboratory test methods employed, and the applicability of these methods as they pertain to the quality of the samples, the type of sediment, and the anticipated design application. You must explain how the engineering properties of each sediment stratum impact the design of your facility. In your explanation, you must describe the uncertainties inherent in your overall testing program, and the reliability and applicability of each test method.	(i) The results of a testing program used to investigate the stratigraphic and engineering properties of the sediment that may impact the foundations or anchoring systems for your facility.	<ul style="list-style-type: none"> • Section 4.3.2. Geological Conditions • Appendix G1. Marine Site Investigation Report • Appendix H. Sediment Transport Modeling Report • Note: Sunrise Wind requested a departure from 30 CFR § 585.626(a)(4)(ii) and (iii) to submit these results prior to construction as part of the FDR required under 30 CFR § 585.701. BOEM approved this request on April 26, 2021.
	(ii) The results of adequate <i>in situ</i> testing, boring, and sampling at each foundation location, to examine all important sediment and rock strata to determine its strength classification, deformation properties, and dynamic characteristics.	
	(iii) The results of a minimum of one deep boring (with soil sampling and testing) at each edge of the project area and within the project area as needed to determine the vertical and lateral variation in seabed conditions and to provide the relevant geotechnical data required for design.	
5) Archaeological resources. The results of the archaeological resource survey with supporting data.	A description of the historic and prehistoric archaeological resources, as required by the <i>National Historic Preservation Act</i> (NHPA) (54 USC 300101 et seq.), as amended.	<ul style="list-style-type: none"> • Section 4.6. Cultural Resources • Appendix R. Marine Archaeological Resources Assessment • Appendix S1. Terrestrial Archaeological Resources Assessment • Appendix S2. Terrestrial Archaeological Resources Phase IB Assessment

CONSTRUCTION AND OPERATIONS PLAN

Introduction – BOEM COP Requirements and Lease Stipulations

BOEM Requirements		Location in COP
<p>6) Overall site investigation.</p> <p>An overall site investigation report for your facility that integrates the findings of your shallow hazards surveys and geologic surveys, and, if required, your subsurface surveys with supporting data.</p>	An analysis of the potential for:	<ul style="list-style-type: none"> • Section 4.3.2. Geological Conditions • Appendix G1. Marine Site Investigation Report
	(i) Scouring of the seabed;	
	(ii) Hydraulic instability;	
	(iii) The occurrence of sand waves;	
	(iv) Instability of slopes at the facility location;	
	(v) Liquefaction, or possible reduction of sediment strength due to increased pore pressures;	
	(vi) Degradation of subsea permafrost layers;	
	(vii) Cyclic loading;	
	(viii) Lateral loading;	
	(ix) Dynamic loading;	
	(x) Settlements and displacements;	
	(xi) Plastic deformation and formation collapse mechanisms; and	
(xii) Sediment reactions on the facility foundations or anchoring systems.		
<p>30 CFR § 585.626(b) - Your COP must include the following project-specific information, as applicable.</p>		
1) Contact Information.	The name, address, e-mail address, and phone number of an authorized representative.	<ul style="list-style-type: none"> • Section 1.6.1 Authorized Representative and Designated Operator
2) Designation of operator, if applicable	As provided in § 585.405.	<ul style="list-style-type: none"> • Section 1.6.1 Authorized Representative and Designated Operator
3) The construction and operation concept	A discussion of the objectives,	<ul style="list-style-type: none"> • Section 1.3. Project Purpose
	Description of the proposed activities,	<ul style="list-style-type: none"> • Section 1.1. Project Overview • Section 3.0. Description of Proposed Activity
	Tentative schedule from start to completion, and	<ul style="list-style-type: none"> • Section 3.2.2 Project Schedule
	Plans for phased development, as provided in § 585.629.	<ul style="list-style-type: none"> • Not applicable. The Project is a single, complete, and independent project that will not be developed in phases
4) Commercial lease stipulations and compliance	A description of the measures you took, or will take, to satisfy the conditions of any lease stipulations related to your proposed activities.	<ul style="list-style-type: none"> • Table ES-1. Executive Summary • Section 1.4 Regulatory Framework • Section 4.9. Summary of Potential Impacts and Environmental Protection Measures
5) A location plat	The surface location and water depth for all proposed structures, facilities, and appurtenances located both offshore and onshore, including all anchor/mooring data.	<ul style="list-style-type: none"> • Section 1.1. Project Overview • Section 3.0. Description of Proposed Activity • Appendix F. Conceptual Project Engineering Design Drawings/Additional Project Information
6) General structural and project design, fabrication, and installation.	Information for each type of structure associated with your project and, unless BOEM provides otherwise, how you will use a Certified Verification Agent (CVA) to review and verify each stage of the project.	<ul style="list-style-type: none"> • Section 1.6.2. Certified Verification Agent • Section 3.0. Description of Proposed Activity • Appendix D. Certified Verification Agent • Appendix F. Conceptual Project Engineering Design Drawings/Additional Project Information

CONSTRUCTION AND OPERATIONS PLAN

Introduction – BOEM COP Requirements and Lease Stipulations

BOEM Requirements		Location in COP
7) All cables and pipelines, including cables on project easements.	Location, design and installation methods, testing, maintenance, repair, safety devices, exterior corrosion protection, inspections, and decommissioning.	<ul style="list-style-type: none"> • Section 3.0. Description of Proposed Activity
8) A description of the deployment activities	Safety, prevention, and environmental protection features or measures that you will use.	<ul style="list-style-type: none"> • Section 3.0. Description of Proposed Activity • Section 4.9. Summary of Potential Impacts and Environmental Protection Measures • Appendix E1. Emergency Response Plan/Oil Spill Response Plan • Appendix E2. Safety Management System • Appendix X. Navigation Safety Risk Assessment
9) A list of solid and liquid wastes generated	Disposal methods and locations.	<ul style="list-style-type: none"> • Section 3.0. Description of Proposed Activity • Section 4.2.5. Discharges and Releases
10) A listing of chemical products used (if stored volume exceeds Environmental Protection Agency (EPA) Reportable Quantities).	<p>A list of chemical products used; the volume stored on location; their treatment, discharge, or disposal methods used; and the name and location of the onshore waste receiving, treatment, and/or disposal facility.</p> <p>A description of how these products will be brought onsite, the number of transfers that may take place, and the quantity that that will be transferred each time.</p>	<ul style="list-style-type: none"> • Section 3.0. Description of Proposed Activity • Appendix E1. Emergency Response Plan/Oil Spill Response Plan
11) A description of any vessels, vehicles, and aircraft you will use to support your activities.	An estimate of the frequency and duration of vessel/vehicle/aircraft traffic.	<ul style="list-style-type: none"> • Section 3.0. Description of Proposed Activity • Section 4.2.7. Traffic (Vessels, Vehicles, Air) • Section 4.8. Transportation and Navigation • Appendix X. Navigation Safety Risk Assessment
12) A general description of the operating procedures and systems.	(i) Under normal conditions.	<ul style="list-style-type: none"> • Section 3.5. Operations and Maintenance
	(ii) In the case of accidents or emergencies, including those that are natural or manmade.	<ul style="list-style-type: none"> • Section 3.5. Operations and Maintenance • Appendix E1. Emergency Response Plan/Oil Spill Response Plan • Appendix E2. Safety Management System • Appendix X. Navigation Safety Risk Assessment
13) Decommissioning and site clearance procedures	A discussion of general concepts and methodologies.	<ul style="list-style-type: none"> • Section 3.6. Decommissioning
14) A listing of all Federal, State, and local authorizations, approvals, or permits that are required to conduct the proposed activities, including commercial operations.	(i) The U.S. Coast Guard (U.S. Coast Guard), U.S. Army Corps of Engineers (USACE), and any other applicable authorizations, approvals, or permits, including any Federal, State or local authorizations pertaining to energy gathering, transmission or distribution (e.g., interconnection authorizations).	<ul style="list-style-type: none"> • Section 1.4. Regulatory Framework
	(ii) A statement indicating whether you have applied for or obtained such authorization, approval, or permit.	<ul style="list-style-type: none"> • Section 1.4. Regulatory Framework
15) Your proposed measures for avoiding, minimizing, reducing, eliminating, and monitoring environmental impacts.	A description of the measures you will use to avoid or minimize adverse impacts and any potential incidental take before you conduct activities on your lease, and how you will mitigate environmental impacts from your proposed activities, including a description of the measures you will use as required by subpart H of this part.	<ul style="list-style-type: none"> • Section 4.9. Summary of Potential Impacts and Environmental Protection Measures
16) Information you incorporate by reference	A listing of the documents you referenced.	<ul style="list-style-type: none"> • Section 5. References • Appendices A–Y
17) A list of agencies and persons with whom you have communicated, or with whom you will communicate, regarding potential impacts associated with your proposed activities.	Contact information and issues discussed.	<ul style="list-style-type: none"> • Section 1.5. Agency and Stakeholder Outreach • Appendix A. Agency Correspondence
18) Reference	A list of any document or published source that you cite as part of your plan. You may reference information and data discussed in other plans you previously submitted or that are otherwise readily available to BOEM.	<ul style="list-style-type: none"> • Section 5. References • Appendices A–Y

CONSTRUCTION AND OPERATIONS PLAN

Introduction – BOEM COP Requirements and Lease Stipulations

BOEM Requirements		Location in COP
19) Financial assurance	Statements attesting that the activities and facilities proposed in your COP are or will be covered by an appropriate bond or security, as required by §§ 585.515 and 585.516.	<ul style="list-style-type: none"> • Section 1.6.5. Financial Assurance
20) CVA nominations for reports required in subpart G of this part.	CVA nominations for reports in subpart G of this part, as required by § 585.706, or a request for a waiver under § 585.705(c).	<ul style="list-style-type: none"> • Section 1.6.2. Certified Verification Agent • Appendix D. Certified Verification Agent
21) Construction schedule	A reasonable schedule of construction activity showing significant milestones leading to the commencement of commercial operations.	<ul style="list-style-type: none"> • Section 3.2.2 Project Schedule
22) Air quality information	As described in § 585.659 of this section.	<ul style="list-style-type: none"> • Section 4.3.4. Air Quality • Appendix K. Air Emissions Inventory
23) Other information	Additional information as required by BOEM.	<ul style="list-style-type: none"> • Not applicable. No additional information not already covered within this table.
30 CFR § 585.627(a) - You must submit with your COP detailed information to assist BOEM in complying with NEPA and other relevant laws. Your COP must describe those resources, conditions, and activities listed in the following table that could be affected by your proposed activities, or that could affect the activities proposed in your COP, including:		
1) Hazard Information	Meteorology and oceanography.	<ul style="list-style-type: none"> • Section 4.3.1. Oceanographic and Meteorological Conditions
	Sediment transport, geology, and shallow geological or manmade hazards.	<ul style="list-style-type: none"> • Section 4.3.2. Geological Conditions • Appendix G1. Marine Site Investigation Report • Appendix G2. MEC/UXO Risk Assessment with Risk Mitigation Strategy • Appendix H. Sediment Transport Modeling Report
2) Water Quality	Turbidity and total suspended solids from construction.	<ul style="list-style-type: none"> • Section 4.3.3. Water Quality • Appendix G1. Marine Site Investigation Report • Appendix H. Sediment Transport Modeling Report • Appendix L. Onshore Ecological Assessment and Field Survey Report
3) Biological resources	Benthic communities.	<ul style="list-style-type: none"> • Section 4.4.2. Benthic and Shellfish Resources • Appendix J1. Offshore EMF Assessment • Appendix M1. Benthic Resources Characterization Report – Federal Waters • Appendix M2. Benthic Resources Characterization Report – New York State Waters • Appendix M3. Benthic Habitat Mapping Report
	Marine mammals.	<ul style="list-style-type: none"> • Section 4.4.4. Marine Mammals • Appendix I1. Underwater Acoustic Assessment • Appendix J1. Offshore EMF Assessment • Appendix O. Marine Mammal, Sea Turtle, and ESA-Listed Fish Assessment Report
	Sea turtles.	<ul style="list-style-type: none"> • Section 4.4.5. Sea Turtles • Appendix I1. Underwater Acoustic Assessment • Appendix J1. Offshore EMF Assessment • Appendix O. Marine Mammal, Sea Turtle, and ESA-Listed Fish Assessment Report
	Coastal and marine birds.	<ul style="list-style-type: none"> • Section 4.4.6. Avian Species • Appendix P. Avian and Bat Risk Assessment

CONSTRUCTION AND OPERATIONS PLAN

Introduction – BOEM COP Requirements and Lease Stipulations

BOEM Requirements		Location in COP
3) Biological resources (cont'd)	Fish and shellfish.	<ul style="list-style-type: none"> • Section 4.4.2. Benthic and Shellfish Resources • Section 4.4.3. Finfish and Essential Fish Habitat • Appendix I1. Underwater Acoustic Assessment • Appendix J1. Offshore EMF Assessment • Appendix M1. Benthic Resources Characterization Report – Federal Waters • Appendix M2. Benthic Resources Characterization Report – New York State Waters • Appendix M3. Benthic Habitat Mapping Report • Appendix N. Essential Fish Habitat Assessment
	Plankton.	<ul style="list-style-type: none"> • Section 4.4.3. Finfish and Essential Fish Habitat • Appendix N. Essential Fish Habitat Assessment
	Seagrasses.	<ul style="list-style-type: none"> • Section 4.4.1. Coastal and Terrestrial Habitat • Section 4.4.2. Benthic and Shellfish Resources • Section 4.4.3. Finfish and Essential Fish Habitat • Appendix G1. Marine Site Investigation Report • Appendix M1. Benthic Resources Characterization Report – Federal Waters • Appendix M2. Benthic Resources Characterization Report – New York State Waters • Appendix M3. Benthic Habitat Mapping Report • Appendix N. Essential Fish Habitat Assessment
	Plant life.	<ul style="list-style-type: none"> • Section 4.4.1. Coastal and Terrestrial Habitat • Section 4.4.2. Benthic and Shellfish Resources • Section 4.4.3. Finfish and Essential Fish Habitat • Appendix M1. Benthic Resources Characterization Report – Federal Waters • Appendix M2. Benthic Resources Characterization Report – New York State Waters • Appendix M3. Benthic Habitat Mapping Report • Appendix L. Onshore Ecological Assessment and Field Survey Report
4) Threatened or endangered species	As defined by the <i>Endangered Species Act of 1973 (ESA)</i> (16 USC 1531 et seq.).	<ul style="list-style-type: none"> • Section 4.4.3. Finfish and Essential Fish Habitat • Section 4.4.4. Marine Mammals • Section 4.4.5. Sea Turtles • Section 4.4.6. Avian Species • Section 4.4.7. Bats • Appendix G1. Marine Site Investigation Report • Appendix L. Onshore Ecological Assessment and Field Survey Report • Appendix O. Marine Mammal, Sea Turtle, and ESA-Listed Fish Assessment Report • Appendix P. Avian and Bat Risk Assessment

CONSTRUCTION AND OPERATIONS PLAN

Introduction – BOEM COP Requirements and Lease Stipulations

BOEM Requirements		Location in COP
5) Sensitive biological resources or habitats	Essential fish habitat.	<ul style="list-style-type: none"> • Section 4.4.3. Finfish and Essential Fish Habitat • Appendix N. Essential Fish Habitat Assessment
	Refuges and preserves.	<ul style="list-style-type: none"> • Section 4.3.3. Water Quality • Section 4.4.1. Coastal and Terrestrial Habitat • Section 4.7.5. Other Marine Uses and Coastal Land Use • Appendix G1. Marine Site Investigation Report • Appendix L. Onshore Ecological Assessment and Field Survey Report
	Special management areas identified in coastal management programs, sanctuaries, rookeries.	<ul style="list-style-type: none"> • Section 4.3.3. M • Section 4.4.1. Coastal and Terrestrial Habitat • Section 4.4.6. Avian Species • Section 4.4.7. Bats • Section 4.7.5. Other Marine Uses and Coastal Land Use • Appendix G1. Marine Site Investigation Report • Appendix L. Onshore Ecological Assessment and Field Survey Report
	Hard bottom habitat.	<ul style="list-style-type: none"> • Section 4.3.2. Geological Conditions • Section 4.4.2. Benthic and Shellfish Resources • Appendix G1. Marine Site Investigation Report • Appendix M1. Benthic Resources Characterization Report – Federal Waters • Appendix M2. Benthic Resources Characterization Report – New York State Waters • Appendix M3. Benthic Habitat Mapping Report
	Chemosynthetic communities.	<ul style="list-style-type: none"> • Not applicable. Chemosynthetic communities are not expected to be found within the Project Area.
	Calving grounds.	<ul style="list-style-type: none"> • Not applicable. Calving grounds are not expected to be found within the Project Area.
	Barrier islands, beaches, and dunes.	<ul style="list-style-type: none"> • Section 4.4.1. Coastal and Terrestrial Habitat
	Wetlands.	<ul style="list-style-type: none"> • Section 4.4.1. Coastal and Terrestrial Habitat
6) Archaeological resources	As required by the NHPA (54 USC 300101 et seq.), as amended.	<ul style="list-style-type: none"> • Section 4.6. Cultural Resources • Appendix R. Marine Archaeological Resources Assessment • Appendix S1. Terrestrial Archaeological Resources Assessment • Appendix S2. Terrestrial Archaeological Resources Phase IB Assessment • Appendix T. Historic Resources Visual Effects Assessment • Appendix U. Onshore Above-ground Historic Properties Report
7) Social and Economic resources	Employment.	<ul style="list-style-type: none"> • Section 4.7.1. Employment, Economics, and Demographics • Appendix W. Economic Modeling Report
	Existing offshore and coastal infrastructure (including major sources of supplies, services, energy, and water).	<ul style="list-style-type: none"> • Section 4.7.2. Public Services • Section 4.7.5. Other Marine Uses and Coastal Land Use
	Land use.	<ul style="list-style-type: none"> • Section 4.7.5. Other Marine Uses and Coastal Land Use
	Subsistence resources and harvest practices.	<ul style="list-style-type: none"> • Section 4.7.4. Commercial and Recreational Fisheries

CONSTRUCTION AND OPERATIONS PLAN

Introduction – BOEM COP Requirements and Lease Stipulations

BOEM Requirements		Location in COP
7) Social and Economic resources (cont'd)	Recreation, recreational and commercial fishing (including typical fishing seasons, location, and type).	<ul style="list-style-type: none"> • Section 4.7.4. Commercial and Recreational Fisheries • Appendix B. Fisheries Communication Plan • Appendix V. Commercial and Recreational Fisheries Data Report
	Minority and lower income groups.	<ul style="list-style-type: none"> • Section 4.7.1. Employment, Economics, and Demographics • Section 4.7.6. Environmental Justice
	Coastal zone management programs.	<ul style="list-style-type: none"> • Appendix C. Coastal Zone Management Consistency Certifications
	Viewshed.	<ul style="list-style-type: none"> • Section 4.5.1. Visual Resources • Section 4.6.3. Above-ground Historic Properties • Appendix Q1. Offshore Visual Impacts Assessment • Appendix Q2. Onshore Visual Resources Assessment • Appendix T. Historic Resources Visual Effects Assessment • Appendix U. Onshore Above-ground Historic Properties Report
8) Coastal and marine uses	Military activities.	<ul style="list-style-type: none"> • Section 4.7.5. Other Marine Uses and Coastal Land Use • Section 4.8.1 Marine Transportation • Appendix X. Navigation Safety Risk Assessment
	Vessel traffic.	
	Energy and nonenergy mineral exploration or development.	
9) Consistency Certification	As required by the <i>Coastal Zone Management Act (CZMA)</i> : (i) 15 CFR part 930, subpart D, for non-competitive leases. (ii) 15 CFR part 930, subpart E, for competitive leases.	<ul style="list-style-type: none"> • Appendix C. Coastal Zone Management Consistency Certifications
10) Other resources, conditions, and activities	As identified by BOEM.	<ul style="list-style-type: none"> • Not applicable. No additional resources, conditions, or activities as identified by BOEM at this time.
30 CFR § 585.627(b) - You must submit one paper copy and one electronic copy of your consistency certification. Your consistency certification must include:		
CZMA Consistency Certification	1) One copy of your consistency certification under subsection 307(c)(3)(B) of the CZMA (16 USC 1456(c)(3)(B)) and 15 CFR 930.76 stating that the proposed activities described in detail in your plans comply with the State(s) approved coastal management program(s) and will be conducted in a manner that is consistent with such program(s); 2) "Information," as required by 15 CFR 930.76(a) and 15 CFR 930.58(a)(2), and "Analysis," as required by 15 CFR 930.58(a)(3).	<ul style="list-style-type: none"> • Appendix C. Coastal Zone Management Consistency Certifications
30 CFR § 585.627(c)		
Oil Spill Response Plan	In accordance with 30 Part 254.	<ul style="list-style-type: none"> • Appendix E1. Emergency Response Plan/Oil Spill Response Plan
30 CFR § 585.627(d)		
Safety Management System	In accordance with 30 CFR 585.810.	<ul style="list-style-type: none"> • Appendix E2. Safety Management System

CONSTRUCTION AND OPERATIONS PLAN

Introduction – BOEM COP Requirements and Lease Stipulations

Table 1.7-2 Summary of Relevant Lease Requirements for SRWF and SRWEC from OCS-A 0487

Lease Requirements	Description	Compliance Statement/Location within COP
Section 4: Payments (a)	The lessee must make all rent payments to the Lessor in accordance with applicable regulations in 30 CFR Part 585, unless otherwise specified Addendum "B".	Sunrise Wind will comply.
Section 4: Payments (b)	The Lessee must make all operating fee payments to the Lessor in accordance with applicable regulations in 30 CFR Part 585, as specified in Addendum "B".	Sunrise Wind will comply.
Section 5: Plans	The Lessee may conduct those activities described in Addendum "A" only in accordance with a Site Assessment Plan (SAP) or COP approved by the Lessor. The Lessee may not deviate from an approved SAP or COP except as provided in applicable regulations in 30 CFR Part 585.	Understood.
Section 6: Associated Project Easements	Pursuant to 30 CFR 585.200(b), the Lessee has the right to one or more project easements, without further competition, for the purpose of installing, gathering, transmission, and distribution cables, pipelines, and appurtenances on the OCS, as necessary for the full enjoyment of the lease, and under applicable regulations in 30 CFR Part 585. As part of submitting a COP for approval, the Lessee may request that one or more easement(s) be granted by the Lessor. If the Lessee requests that one or more easements be granted when submitting a COP for approval, such project easements will be granted by the Lessor in accordance with the Act and applicable regulations in 30 CFR Part 585 upon approval of the COP in which the Lessee has demonstrated a need for such easements. Such easements must be in a location acceptable to the Lessor and will be subject to such conditions as the Lessor may require. The project easements that would be issued in conjunction with an approved COP under this lease will be described in Addendum "D" to this lease, which will be updated as necessary.	With approval of this COP, Sunrise Wind requests that BOEM issue a project easement for the portions of SRWEC located in federal waters, under the applicable regulations in 30 CFR Part 585.
Section 7: Conduct of Activities	<p>The Lessee must conduct, and agrees to conduct, all activities in the leased area in accordance with an approved SAP or COP, and with all applicable laws and regulations.</p> <p>The Lessee further agrees that no activities authorized by this lease will be carried out in a manner that:</p> <ul style="list-style-type: none"> (a) could unreasonably interfere with or endanger activities or operations carried out under any lease or grant issued or maintained pursuant to the Act, or under any other license or approval from any Federal agency; (b) could cause any undue harm or damage to the environment; (c) could create hazardous or unsafe conditions; or (d) could adversely affect sites, structures, or objects of historical, cultural, or archaeological significance, without notice to and direction from the Lessor on how to proceed. 	Sunrise Wind will comply.

CONSTRUCTION AND OPERATIONS PLAN

Introduction – BOEM COP Requirements and Lease Stipulations

Lease Requirements	Description	Compliance Statement/Location within COP
Section 10: Financial Assurance	The Lessee must provide and maintain at all times a surety bond(s) or other form(s) of financial assurance approved by the Lessor in the amount specified in Addendum "B". As required by the applicable regulations in 30 CFR Part 585, if, at any time during the term of this lease, the Lessor requires additional financial assurance, then the Lessee must furnish the additional financial assurance required by the Lessor in a form acceptable to the Lessor within 90 days after receipt of the Lessor's notice of such adjustment.	Section 1.6.5 Financial Assurance
Section 13: Removal of Property and Restoration of the Leased Area on Termination of Lease	Unless otherwise authorized by the Lessor, pursuant to the applicable regulations in 30 CFR Part 585, the Lessee must remove or decommission all facilities, projects, cables, pipelines, and obstructions and clear the seafloor of all obstructions created by activities on the leased area, including any project easements within two years following lease termination, whether by expiration, cancellation, contraction, or relinquishment, in accordance with any approved SAP, COP, or approved Decommissioning Application, and applicable regulations in 30 CFR Part 585.	Section 3.6 Decommissioning
Section 14: Safety Requirements	<p>The Lessee must:</p> <p>(a) Maintain all places of employment for activities authorized under this lease in compliance with occupational safety and health standards and, in addition, free from recognized hazards to employees of the Lessee or of any contractor or subcontractor operating under this lease;</p> <p>(b) Maintain all operations within the leased areas in compliance with regulations in 30 CFR Part 585 and orders from the Lessor and other Federal agencies with jurisdiction, intended to protect persons, property and the environment on the OCS; and</p> <p>(c) Provide any requested documents and records, which are pertinent to occupational or public health, safety, or environmental protection, and allow prompt access, at the site of any operation or activity conducted under this lease, to any inspector authorized by the Lessor or other Federal agency with jurisdiction.</p>	<p>Section 1.4 Regulatory Framework</p> <p>Appendix E2 Safety Management Systems</p>
Section 15: Debarment Compliance	The Lessee must comply with the Department of the Interior's non-procurement debarment and suspension regulations set forth in 2 CFR Parts 180 and 1400 and must communicate the requirement to comply with these regulations to persons with whom it does business related to this lease by including this requirement in all relevant contracts and transactions	Sunrise Wind will comply.

CONSTRUCTION AND OPERATIONS PLAN

Introduction – BOEM COP Requirements and Lease Stipulations

Lease Requirements	Description	Compliance Statement/Location within COP
Section 16: Notices	All notices or reports provided from one party to the other under the terms of this lease must be in writing except as provided herein and in the applicable regulations in 30 CFR Part 585. Written notices must be delivered to the party's Lease Representative, as specifically listed in Addendum "A," either electronically, by hand, by facsimile, or by United States first class mail, adequate postage prepaid. Either party may notify the other of a change of address by doing so in writing. Until notice of any change of address is delivered as provided in this section, the last recorded address of either party will be deemed the address for all notices required under this lease. For all operational matters, notices must be provided to the party's Operations Representative, as specifically listed in Addendum "A," as well as the Lease Representative.	Sunrise Wind will comply.
Addendum B - Lease Term and Financial Schedule; Section III - Payments	Unless otherwise authorized by the Lessor in accordance with the applicable regulations in 30 CFR Part 585, the Lessee must make payments as described below (see Lease document for payment schedule).	Sunrise Wind will comply.

This page intentionally left blank

CONSTRUCTION AND OPERATIONS PLAN

Project Siting and Design Development – Siting History

SECTION 2 – PROJECT SITING AND DESIGN DEVELOPMENT

This section presents a description of the siting process undertaken by Sunrise Wind for development of the Project. Section 2.1 presents the siting history, including the siting of the Rhode Island/Massachusetts Wind Energy Area (RI-MA WEA) and the Massachusetts Wind Energy Area (MA WEA), establishment of the Lease Area, and the proposed location of the SRWF. Section 2.2 provides a summary of the alternatives considered by Sunrise Wind for the siting, design, and construction of the Project. Section 2.3 summarizes the proposed Project, which is described in further detail in Section 3.

2.1 Siting History

SRWF is located in Lease OCS-A 0487, which is located both in OCS blocks that were previously designated as Lease OCS-A 0487 in the RI-MA WEA as well as OCS blocks designated as Lease OCS-A 0500 in the MA WEA. This section provides the history of the siting and screening of the RI-MA WEA and the MA WEA, which are now generally described together as the New England WEA.

In 2013, BOEM designated and auctioned the RI-MA WEA as two lease areas (North Lease OCS-A 0486 and South Lease OCS-A 0487). Both leases were competitively awarded to Deepwater Wind New England LLC. The North Lease Area consisted of 97,498 acres (39,456 ha) and the South Lease Area consisted of approximately 67,252 acres (27,216 ha) (Figure 2.1-1). In 2015, BOEM competitively awarded the MA WEA (Lease OCS-A 0500) to RES America Developments, Inc, consisting of approximately 187,523 acres (75,888 ha), and it was subsequently assigned to Bay State Wind, LLC (Figure 2.1-1).

Sunrise Wind requested that BOEM assign a portion of Lease OCS-A 0500 (Bay State Wind, LLC) and the entirety of Lease Area OCS-A 0487 (formerly Deepwater Wind New England LLC) to Sunrise Wind LLC, and to merge the two areas to accommodate the SRWF. The assignment to Sunrise Wind LLC was approved on September 3, 2020, and the two areas were merged and a revised Lease OCS-A 0487 was issued on March 15, 2021.

This page intentionally left blank

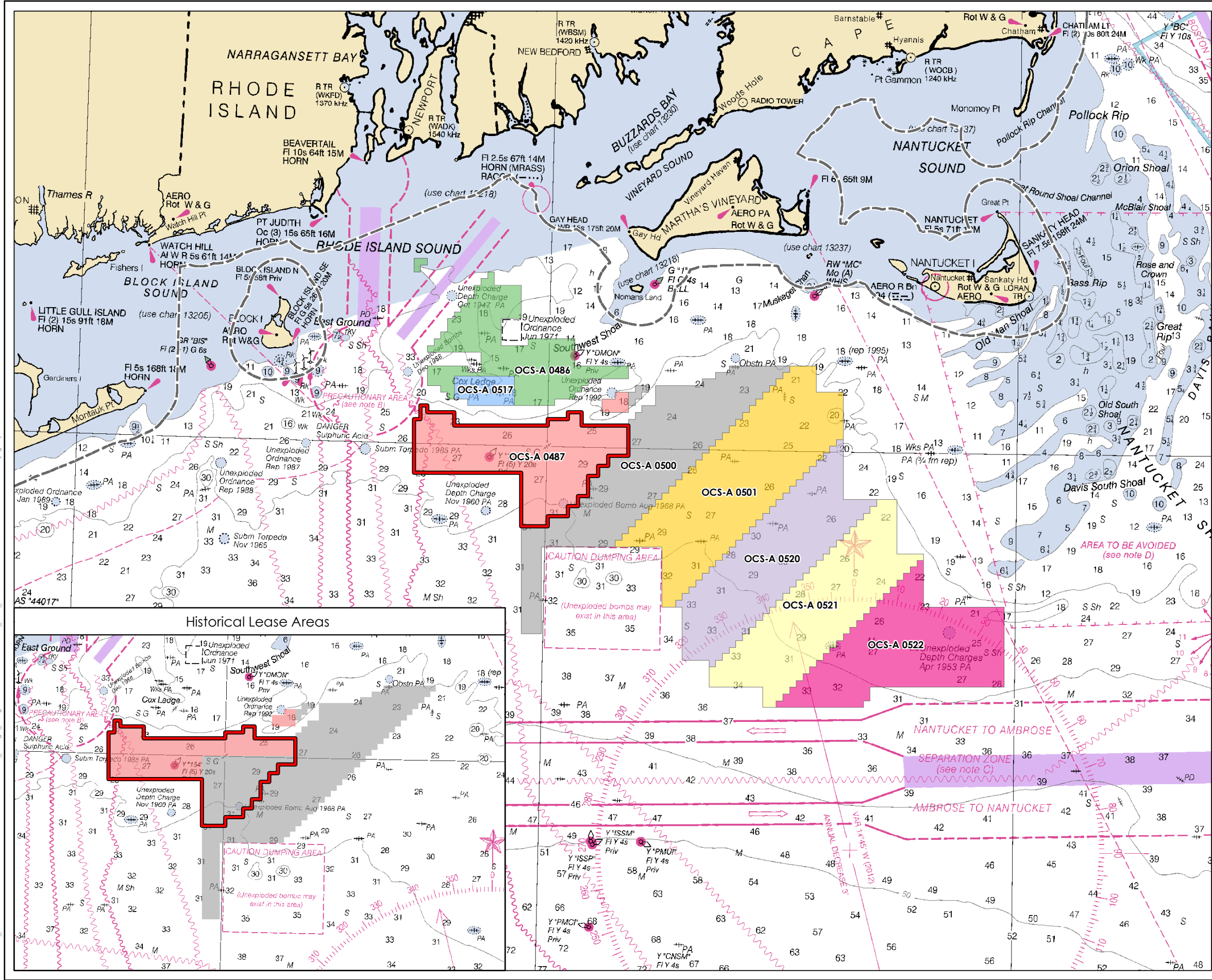

Figure 2.1-1
Location of Lease Areas

Sunrise Wind | Powered by Ørsted & Eversource

Legend

- Sunrise Wind Farm (SRWF)
- 3-nm State Waters Boundary

BOEM Lease Area

- OCS-A 0486
- OCS-A 0487
- OCS-A 0500
- OCS-A 0517
- OCS-A 0501
- OCS-A 0520
- OCS-A 0521
- OCS-A 0522

Sources
BOEM, Ørsted
Base Map: NOAA Chart 13006

Date	12/18/2020 Revised: 6/1/2021
Project Number	2028113199
Prepared By	GC
Reviewed By	LJ

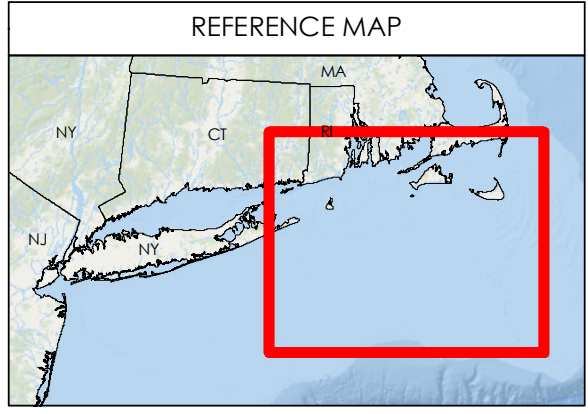
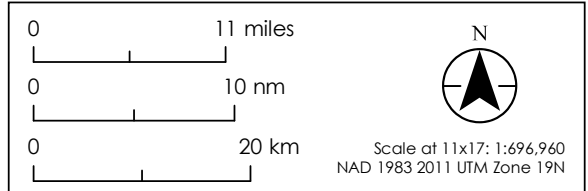

V:\1956\active\Task Owner and other Non-BC1956\Jobs\2028113199\2.1-1_LeaseLocations.mxd Revised: 2021-05-20 By: gspanier

This page intentionally left blank

CONSTRUCTION AND OPERATIONS PLAN

Project Siting and Design Development – Siting History

2.1.1 Siting and Screening of the RI-MA WEA and MA WEA

The siting of the RI-MA WEA and MA WEA were the result of a multi-year effort by state and federal regulatory agencies to identify OCS areas suitable for offshore renewable energy development. The areas were identified based on four years of preliminary site characterization, environmental assessment, and stakeholder discussions that occurred during development of the Rhode Island Ocean Special Area Management Plan (SAMP) and the Massachusetts Ocean Management Plan. Significant investment of public resources went into the compilation and review of site characterization data and the assessment of potential environmental impacts. A wide range of impacts were examined including environmental, economic, cultural, and visual resources, and use conflicts.

Several planning efforts organized by federal and state entities involving private and public interest groups, as well as members of the academic community and the public, led to the identification of the areas that were eventually leased.

The primary efforts and process milestones applicable to both the RI-MA WEA and MA WEA were as follows:

- BOEM's 2009 Intergovernmental Renewable Energy Task Forces in Massachusetts and Rhode Island.
- The *2015 Massachusetts Ocean Management Plan*, an update of the 2009 plan, which defined the Commonwealth's goals, siting priorities, and standards, and identified appropriate locations and performance standards for activities, uses, and facilities (Commonwealth of Massachusetts 2015).
- The *Rhode Island Ocean Special Area Management Plan 2010*, which assessed environmental, economic, cultural, and visual resource data, and use conflicts of the entire Ocean SAMP region, creating a baseline of information that was considered during the designation of the RI-MA WEA (RI Coastal Resources Management Council [CRMC] 2015).
- Executive Order (EO) 13547 of July 19, 2010, which established the National Ocean Policy and provided a national framework and governance structure for sustainable management of US ocean, coastal, and Great Lakes resources. This EO began a multi-year process which resulted in the Northeast Regional Ocean Plan (The White House 2010).

2.1.1.1 Rhode Island/Massachusetts Wind Energy Area

The primary efforts and process milestones applicable to the RI-MA WEA and Lease OCS-A 0487 (Figure 2.1-2) were as follows:

- In 2010, the Governors of Rhode Island and Massachusetts signed a Memorandum of Understanding, forming a partnership to collaborate with BOEM and defining an Area of Mutual Interest (AMI) for wind energy project development. The AMI was a contiguous block of 45 OCS lease blocks (256,199 acres or 1,035 square kilometers [km²] or 302 square nm) (BOEM et al. 2010).

CONSTRUCTION AND OPERATIONS PLAN

Project Siting and Design Development – Siting History

- In 2011, BOEM published in the *Federal Register* a Commercial Leasing for Wind Power on the Outer Continental Shelf Offshore Rhode Island and Massachusetts-Call for Information and Nominations (Docket No. BOEM-2011-0049, *76 Federal Register* 51383-51391), requesting expressions of interest from potential wind project developers (BOEM 2011a).
- In 2011, in compliance with its obligations under NEPA, BOEM published in the *Federal Register* a Notice of Intent to Prepare an Environmental Assessment (Docket No. BOEM-2011-0063, *76 Federal Register* 51391-51393) (BOEM 2011b).
- In July 2012, BOEM published a Notice of Availability for the Commercial Wind Lease Issuance and Site Assessment Activities on the Atlantic Outer Continental Shelf Offshore Rhode Island and Massachusetts Environmental Assessment (*77 Federal Register* 39508). A 30-day comment period was opened, and BOEM held public informational meetings in Massachusetts and Rhode Island (BOEM 2012).
- In May 2013, BOEM revised the 2012 Environmental Assessment for the RI-MA WEA to address issues raised by stakeholders and agency consultation about lease issuances and site assessment activities. BOEM issued a Finding of No Significant Impact for these activities within the RI-MA WEA (BOEM 2013a). BOEM reduced the original area considered for leasing based on environmental constraints, efforts to decrease user group conflicts, navigational safety, public health and safety, and stakeholder concerns (e.g., commercial fishing). The key considerations used to refine the RI-MA WEA included:
 - The Governors of Massachusetts and Rhode Island agreement to a boundary that was at least 6 nm (16.7 km or 10.4 mi) away from any coastal area of either state.
 - A lengthy stakeholder and scientific review process that identified “high value” fishing grounds and excluded those areas from the RI-MA WEA. High value fishing includes the overlap between fixed gear fisheries (traps, pots, and gillnets) and mobile fisheries (trawls, dredges). Areas excluded from the RI-MA WEA had three to four types of fishing pressure from participating fisheries such as bottom trawling, scallop dredging, and lobster trap fisheries.
 - Removal of certain aliquots to avoid marine traffic, navigation zones, and an area of unexploded ordinance.
- In July 2013, BOEM held a competitive lease sale (i.e., auction) for the RI-MA WEA. Deepwater Wind New England LLC was identified as the winner of both Lease Area OCS-A 0486 and OCS-A 0487. The commercial wind energy lease of Submerged Lands for Renewable Energy Development on the Outer Continental Shelf (OCS-A 0487) for 67,252 acres (27,216 ha) was signed by BOEM on September 12, 2013, and went into effect on October 1, 2013. Lease Area OCS-A 0487 was subsequently assigned to Sunrise Wind LLC on September 3, 2020, and on March 15, 2021 was merged with the 19,571-acre (7,920-ha) portion of Lease Area OCS-A 0500 that was also assigned to Sunrise Wind LLC on September 3, 2020 (Figure 2.1-2).

CONSTRUCTION AND OPERATIONS PLAN

Project Siting and Design Development – Siting History

The RI-MA WEA and Lease Area OCS-A 0487 were both established by BOEM through a coordinated, rigorous, and thorough siting and screening process consistent with the objectives of the National Ocean Policy and NEPA, and also took into consideration the policies and objectives of the State of Rhode Island and the Commonwealth of Massachusetts.

2.1.1.2 Massachusetts Wind Energy Area

The primary efforts and process milestones applicable to the MA WEA and Lease Area OCS-A 0500 were as follows:

- In 2010, BOEM published in the *Federal Register* a Commercial Leasing for Wind Power on the Outer Continental Shelf Offshore Massachusetts-Request for Interest (Docket No. BOEM-2010-0063, 75 *Federal Register* 2010-32767), requesting expressions of interest from potential wind project developers.
- In 2011, based on public comments and Commonwealth of Massachusetts comments, BOEM reopened the Request for Interest comment period for the selection of the MA WEA.
- In February 2012, BOEM published in the *Federal Register* a Commercial Leasing for Wind Power on the Outer Continental Shelf Offshore Massachusetts-Call for Information and Nominations (Docket ID. BOEM-2011-0116, 77 FR 5820-5830) to identify locations within the offshore Call Area. In addition, BOEM published a Notice of Intent to prepare an Environmental Assessment of the Call Area (77 FR 5830-5832).
- In May 2012, BOEM announced the completion of the MA WEA identification. The area was identified as being located off the coast of Massachusetts beginning approximately 12 nm south of Martha's Vineyard and 13 nm southwest of Nantucket.
- In December 2013, the Department of Energy's National Renewable Energy (NREL) submitted a report to BOEM that focuses on the Massachusetts Wind Energy Area. NREL provided technical assistance to identify and delineate leasing areas for offshore wind energy development within Wind Energy Areas on the Atlantic Coast (NREL 2013).
- In January 2015, BOEM held a competitive lease sale (i.e., auction) for the Wind Energy Area offshore Massachusetts. RES America Developments, Inc. was identified as the winner of Lease Area OCS-A 0500. The commercial wind energy lease of Submerged Lands for Renewable Energy Development on the Outer Continental Shelf (OCS-A 0500) for 187,523 acres (75,888 ha) was signed by BOEM on March 23, 2015, and went into effect on April 1, 2015. It was subsequently assigned to Bay State Wind LLC on June 12, 2015. A 19,571-acre (7,920-ha) portion of Lease Area OCS-A 0500 was subsequently assigned to Sunrise Wind LLC on September 3, 2020, and was merged with Lease Area OCS-A 0487 on March 15, 2021.

The MA WEA and Lease Area OCS-A 0500 were designated for offshore renewable energy development as the result of a coordinated, rigorous, and thorough siting and screening process consistent with the objectives of the National Ocean Policy and NEPA and also took into consideration the policies and objectives of the Commonwealth of Massachusetts.

This page intentionally left blank

V:\1956\active_Task Owner and other Non-BC1956.Jobs\2028113199\03_data\gis_cad\gis\MA\XDs\COP\2028113199_2.1-2_RI_MA_Wind.mxd Revised: 2021-05-07 By: garpenier

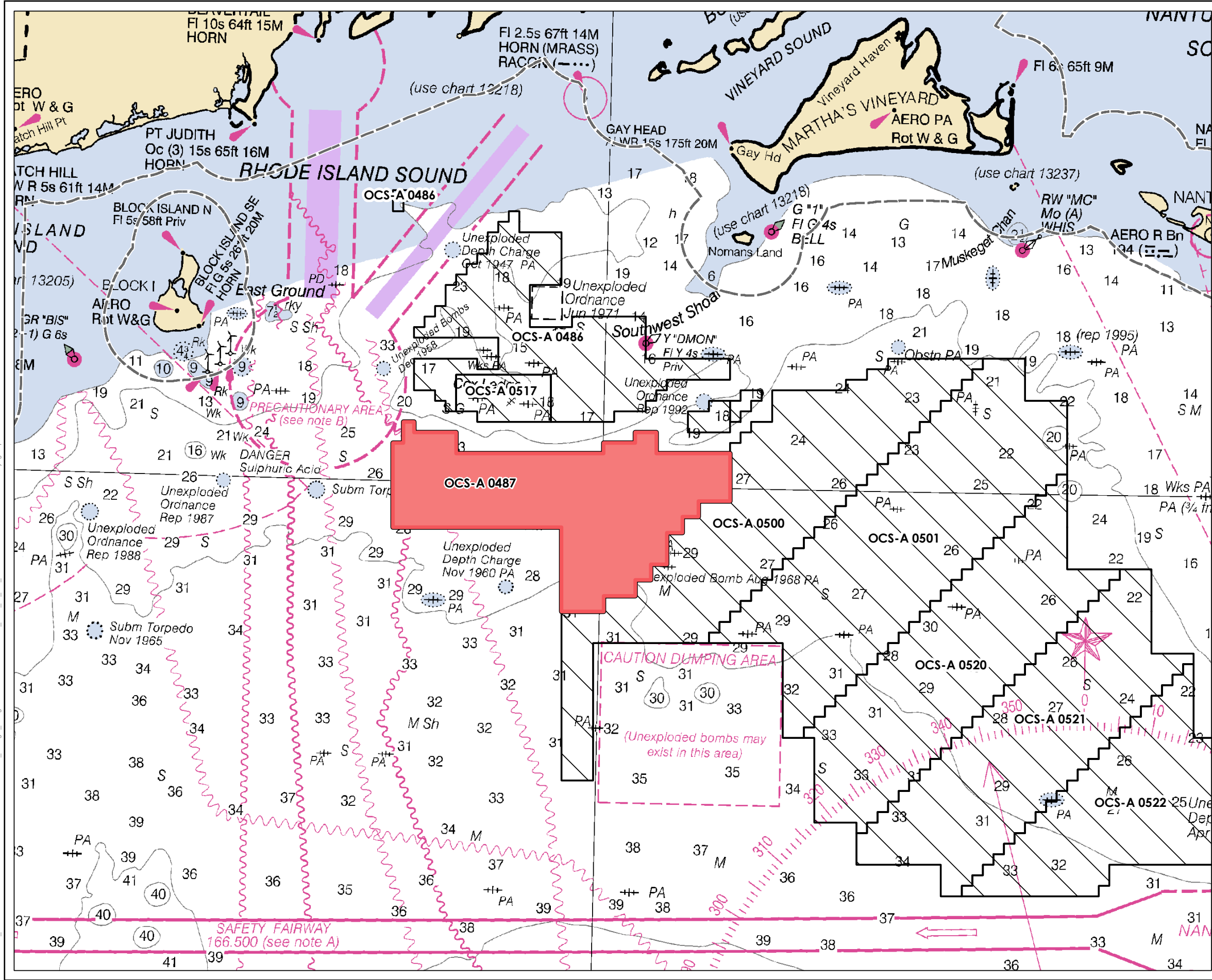

Figure 2.1-2
Siting History for Lease
OCS-A 0487

Sunrise Wind | Powered by Ørsted & Eversource

Legend

- Sunrise Wind Farm (SRWF)
- BOEM Lease Areas
- Other Offshore Lease Area
- 3-nm State Waters Boundary

Sources
 BOEM, Ørsted
 Base Map: NOAA Chart 13006

Date	09/01/2020 Revised: 12/18/2020
Project Number	2028113199
Prepared By	GC
Reviewed By	LJ

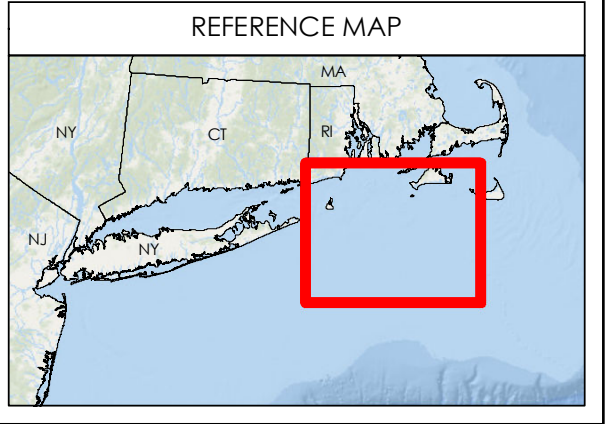
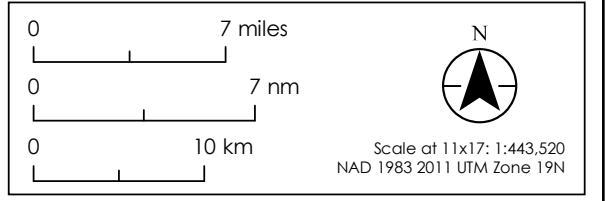

This page intentionally left blank

CONSTRUCTION AND OPERATIONS PLAN

Project Siting and Design Development – Siting History

2.1.2 SRWF Siting and Screening

As described in Section 1.3, the Project executed an OREC Agreement with NYSERDA. The siting and design of the Project was selected to fulfill the OREC Agreement and New York's mandate to develop 9,000 MW of offshore wind energy by 2035. As specified in the OREC Agreement, the Project will generate electricity from an offshore wind farm located in the Lease Area for transmission and delivery to the LIPA Holbrook Substation.

Beginning in 2019, Sunrise Wind conducted comprehensive desktop studies of oceanographic, geologic, shallow hazards, archeological, and environmental resources in the Lease Area. These desktop studies expanded on site characterization information collected from previous geotechnical and geophysical surveys conducted in Lease Area OCS-A 0500 in 2016, 2017, and 2018, and informed the preliminary siting of the Project and supported the development of COP Survey Plans; the associated surveys were conducted in 2019 and 2020. The purpose of these surveys was to conduct the site characterization, marine archaeological, and benthic studies necessary to further evaluate the seabed in the Lease Area and along potential SRWEC routes. The areas surveyed in support of this COP are shown on Figure 1.1-1. The COP Survey Plans were submitted in accordance with the stipulations of the existing Leases, as well as the following BOEM regulations and guidelines:

- *Guidelines for Providing Geophysical, Geotechnical, and Geohazard Information Pursuant to CFR Title 30, Part 585* dated May 27, 2020 (BOEM 2020);
- *Guidelines for Submission of Spatial Data for Atlantic Offshore Renewable Energy Development Site Characterization Survey* dated February 2013 (BOEM 2013b);
- *Guidelines for Providing Archaeological and Historic Property Information Pursuant to 30 CFR Part 585* dated May 27, 2020 (BOEM 2020);
- *Guidelines for Providing Benthic Habitat Survey Information for Renewable Energy Development on the Atlantic Outer Continental Shelf* dated June 2019 (BOEM 2019); and
- *Information Guidelines for a Renewable Energy Construction and Operations Plan (COP)* dated May 27, 2020 (Version 4.0) (BOEM 2020).

CONSTRUCTION AND OPERATIONS PLAN

Project Siting and Design Development – Project Alternatives

2.2 Project Alternatives

Sunrise Wind considered multiple alternatives to achieve the Project purpose (see Section 1.3), which includes delivery of up to 1,300 MW from Lease OCS-A 0487 to the Long Island Power Authority (PSEG LIPA) via a point of interconnection at the Holbrook Substation in the Town of Brookhaven, NY. The evaluation of alternatives was completed in the context of creating the PDE for the Project (see Section 1.2) to allow for reasonable flexibility in certain Project elements while supporting Project review and approval processes by BOEM, as well as other federal, state, and local regulations. The process involved siting, design, and construction alternatives for the Project, including:

- Siting Alternatives
 - Location of onshore transmission facilities, including sites for OnCS–DC, sites for landfall, and routes for Onshore Transmission Cable
 - Location of offshore transmission facilities, including the SRWEC
 - WTG layouts
- Design Alternatives
 - Transmission cable technology
 - WTG models
 - Foundation designs
- Construction Alternatives
 - Onshore Transmission Cable and Onshore Interconnection Cable installation methods
 - Submarine cable installation methods
 - Foundation installation methods

General criteria for the evaluation of alternatives included:

- Meeting the Project purpose, as described in Section 1.3;
- Consideration of environmental resources;
- Consideration of human/social resources;
- Consideration of design characteristics;
- Consideration of construction methodologies and feasibility;
- Consideration of future O&M requirements;
- Implications to the Project schedule; and
- Consideration of capital and maintenance costs.

The following subsections describe the alternatives considered and provide the rationale for their inclusion or exclusion from the proposed Project.

CONSTRUCTION AND OPERATIONS PLAN

Project Siting and Design Development – Project Alternatives

2.2.1 Siting Alternatives

Sunrise Wind undertook a multi-phased approach to evaluate siting alternatives for transmission and interconnection facilities (i.e., Onshore Facilities, including the OnCS–DC, Landfall, and Onshore Transmission Cable, as well as the SRWEC) and the WTG layout. The following sections describe the siting alternatives considered for the Project.

2.2.1.1 Onshore Facilities

Transmission and interconnection facilities are necessary to transmit electricity generated by the Project to the electrical grid. This specifically requires conveying [or delivering] electricity from the offshore wind farm to existing onshore electrical transmission facilities associated with the Project (i.e., the Holbrook Substation). The Project includes multiple transmission and interconnection components: the OnCS–DC and Onshore Interconnection Cable, Onshore Transmission Cable, and SRWEC. Alternatives considered for these Project components are discussed in the following subsections. Once the interconnection point was determined in the OREC Agreement, Sunrise Wind reviewed alternative landfall sites and considered potential routes for Onshore Transmission Cable and SRWEC.

OnCS–DC Siting Alternatives

An OnCS–DC will be constructed to support interconnection to the existing Holbrook Substation, located near Union Avenue at the intersection of the Long Island Expressway (LIE; i.e., Interstate 495) and Route 97 in the Town of Brookhaven, NY.

Sunrise Wind evaluated siting alternatives for the OnCS–DC using the following criteria:

- Proximity to the preferred grid interconnection point and parcel availability;
- A parcel of adequate size (approximately 6 to 10 acres), suitable shape, and ground conditions (e.g., no severe slopes or shallow groundwater);
- Appropriate zoning/land-use compatibility (e.g., avoidance of residential areas and/or other sensitive receptors [schools, hospitals, day care centers, open space, and recreational areas]) for construction and operation of the OnCS–DC; and
- Avoidance or minimization of disturbance to sensitive natural resources (e.g., wetlands, waterbodies, forested areas; other protected and/or ecologically sensitive areas) and/or cultural resources (e.g., areas of potential archaeological sensitivity, avoidance of NRHP structures/sites on the NRHP or tribal lands).

Sunrise Wind identified multiple sites in the general vicinity of the existing Holbrook Substation that were potentially available and undeveloped.

This evaluation generally considered four sites, as depicted in Figure 2.2-1.

- Union Avenue South Site: Located south of Union Avenue in the Town of Brookhaven, NY, this approximately 7-acre (2.8-ha) area includes two parcels to be improved jointly as a common development. This site is approximately 1.0 mi (1.6 km) from the existing Holbrook Substation. This site is currently minimally vegetated and contains gravel and paved locations, multiple buildings, and equipment storage areas associated with various commercial developments;

CONSTRUCTION AND OPERATIONS PLAN

Project Siting and Design Development – Project Alternatives

- Union Avenue North Site: Located north of Union Avenue in the Town of Brookhaven, NY, this approximately 8-acre (3.2-ha) site is located on one parcel. This site is approximately 0.8 mi (1.3 km) from the existing Holbrook substation. This site is currently undeveloped and contains both forested areas and open land;
- North Ocean Avenue Site: A 16-acre (6.5-ha) site with two parcels, located near the intersection of North Ocean Avenue and LIE in the Town of Brookhaven, NY, approximately 3.1 mi (5.0 km) from the existing Holbrook Substation. This site is currently undeveloped and contains primarily forested areas; and
- Long Island Avenue Site: a 15-acre (6.0-ha) site with two parcels, located near the intersection of Horseblock Road, Long Island Ave, and LIE, approximately 5.0 mi (8.0 km) from the existing Holbrook Substation. The site contains both undeveloped and gravel areas.

Evaluated sites for the OnCS–DC are depicted in Figure 2.2-1 and Table 2.2-1 summarizes the constraints that were identified for each site.

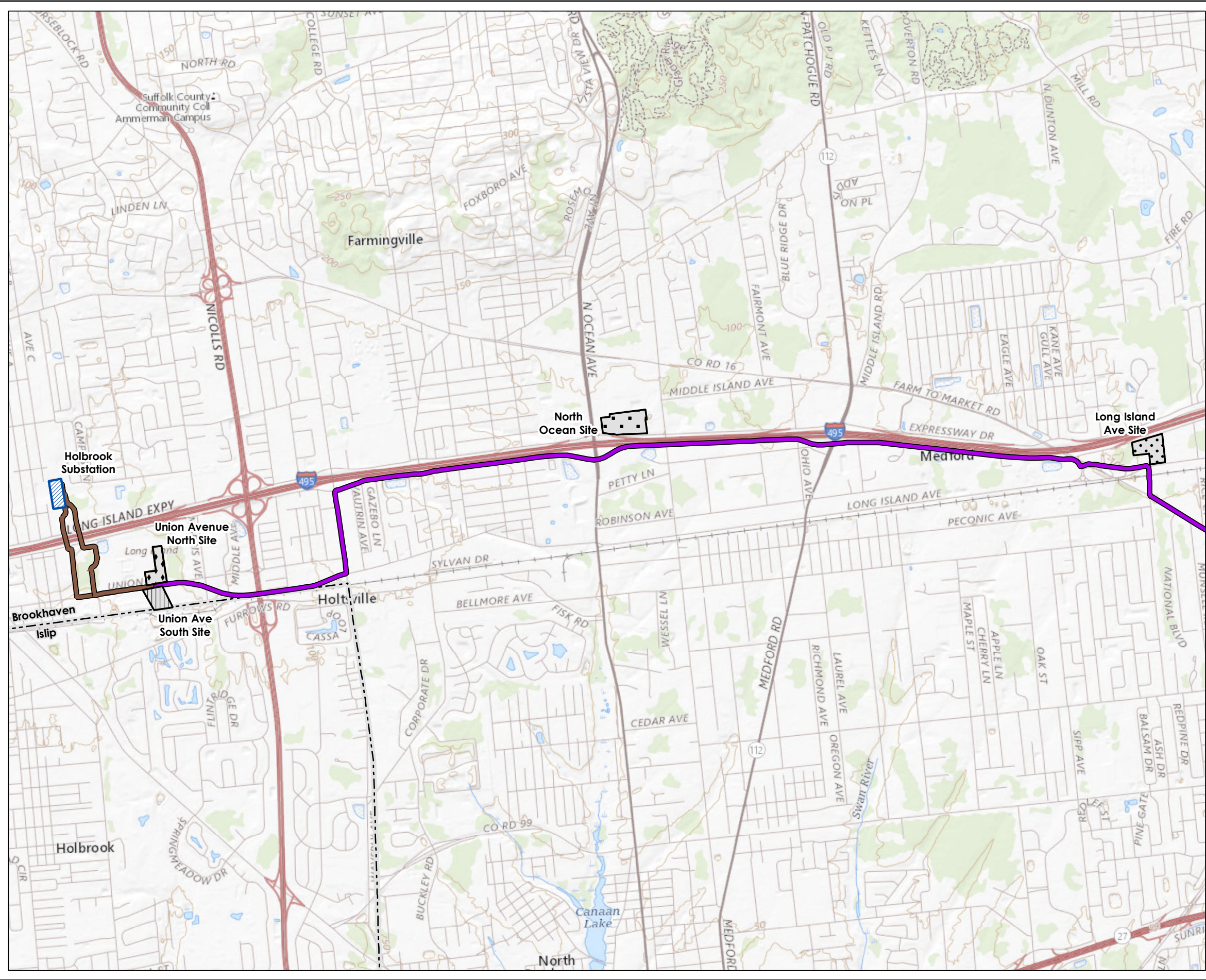

Figure 2.2-1
Onshore Converter Station
Site Alternatives



- Legend**
- Onshore Transmission Cable
 - Onshore Interconnection Cable Route
 - Sunrise Wind Export Cable (SRWEC-NYS)
 - Union Avenue South – Site for Onshore Converter Station
 - Union Avenue North Site
 - Long Island Ave Site
 - North Ocean Site
 - Holbrook Substation

Sources
 NYS Office of IT Services GPO, NYS Boundaries, 2018
 Base Map: USGS Topo

Note
 The cable route centerline and trenchless crossing work areas are indicative and subject to final engineering design.

Date	12/18/2020 Revised: 6/1/2021
Project Number	2028113199
Prepared By	PWB
Reviewed By	SBG

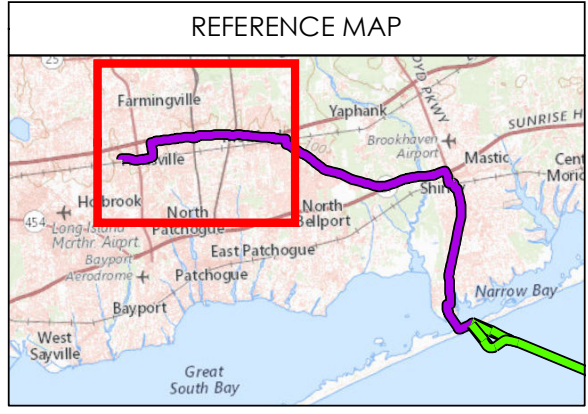
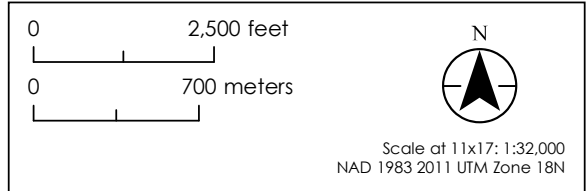

This page intentionally left blank

CONSTRUCTION AND OPERATIONS PLAN

Project Siting and Design Development – Project Alternatives

Table 2.2-1 Summary of Sites Evaluated for OnCS–DC

OnCS DC Sites		Constraints Identified
1	Union Avenue South Site	Site advantageous based on proximity to existing substation and other industrial development. Union Avenue South contains minimal vegetated areas and contains existing buildings and other infrastructure. Site selected for OnCS–DC.
2	Union Avenue North Site	Site advantageous based on proximity to existing substation and other industrial development. Union Avenue North is currently undeveloped and contains both forested areas and open land. Site excluded from further consideration due to clearing and grading requirements, which result in a greater potential for disturbing suitable habitat for protected species, result in a greater chance to encounter archaeological resources, and result in an increase in impervious area and the need for stormwater management facilities to be created.
3	North Ocean Site	Site excluded from further consideration due to distance from existing Holbrook Substation.
4	Long Island Avenue site	Site excluded from further consideration due to distance from existing Holbrook Substation.

As reflected in Table 2.2-1, the North Ocean and Long Island Avenue Sites were removed from consideration as the longer distances from the point of interconnection at the Holbrook Substation would be less advantageous. A factor in site selection for the OnCS–DC is proximity to the point of interconnection via the existing transmission grid and locating a suitable site for the OnCS–DC as close as practical to the point of interconnection is important in reducing Project costs and impacts. Both the Union Avenue North Site and Union Avenue South Site are closer to the Holbrook Substation and are proximal to existing industrial development. However, after further evaluation, the Union Avenue North Site was removed from consideration due to the extent of forest clearing and grading that would be required. As a result of the extent of existing forested areas and need for approximately 4.5 ac (1.8 ha) of tree clearing required at the Union Avenue North Site, there is a greater potential for suitable roosting habitat for the northern long-eared bat (*Myotis septentrionalis*) to exist. As the site is currently undeveloped, there is also a greater potential for encountering archaeological resources during construction activities. Further, the development would result in an increase in impervious area and need for stormwater management facilities to be created. The Union Avenue South Site was ultimately selected for the OnCS–DC due to the fact that the site is in close proximity to other industrial developments, is close to the Holbrook Substation, and contains minimal vegetated areas, as it is currently being utilized for industrial/commercial purposes. The Union Avenue South Site is referenced throughout the remainder of this COP as the “Union Avenue Site¹¹.”

¹¹ The Project is in discussion with the owners of the site regarding acquisition or lease of the property for the Project.

CONSTRUCTION AND OPERATIONS PLAN

Project Siting and Design Development – Project Alternatives

Landfall Alternative Sites

Identification of a suitable landfall site must take into account a variety of factors including:

- Proximity to interconnection point to the onshore transmission grid and proximity to the coastline to minimize the onshore transmission routes;
- Proximity to the Lease Area;
- Technical feasibility, including sufficient available area for cable landfall installation activities, site slope, and other site conditions; and
- Minimal conflicts with existing environmental and anthropogenic constraints and uses, both onshore and offshore.

Sunrise Wind completed a desktop evaluation between the Lease Area and Long Island, New York, to identify constraints of potential offshore cable routes based on publicly available information on oceanography, geology, potential hazards, archaeological and environmental resources, and existing/sensitive infrastructure. This evaluation generally considered two corridors, the Long Island Sound Approach, routed through the Atlantic Ocean and Long Island Sound, and Atlantic Shore Approach, routed through the Atlantic Ocean, south of Long Island. Several constraints were identified with the Long Island Sound Approach including increased offshore distance of cable route; presence of natural rock reefs between Montauk, Block Island, and Orient Point-Fishers Island; presence of numerous significant habitat designations; and higher-concentration of shipwrecks in portions of Long Island Sound Approach than along the Atlantic Shore Approach.

Based on this evaluation, Sunrise Wind investigated potential landfall sites on the south shore of Long Island associated with the Atlantic Shore Approach and conducted a desktop evaluation to identify potential constraints, based on publicly available information on biological resources, geology, potential for contamination, cultural resources, existing and sensitive infrastructure, fisheries, and existing coastal infrastructure projects. Landfall sites evaluated are depicted in Figure 2.2-2 and Table 2.2-2 summarizes the constraints that were identified for each landfall site.

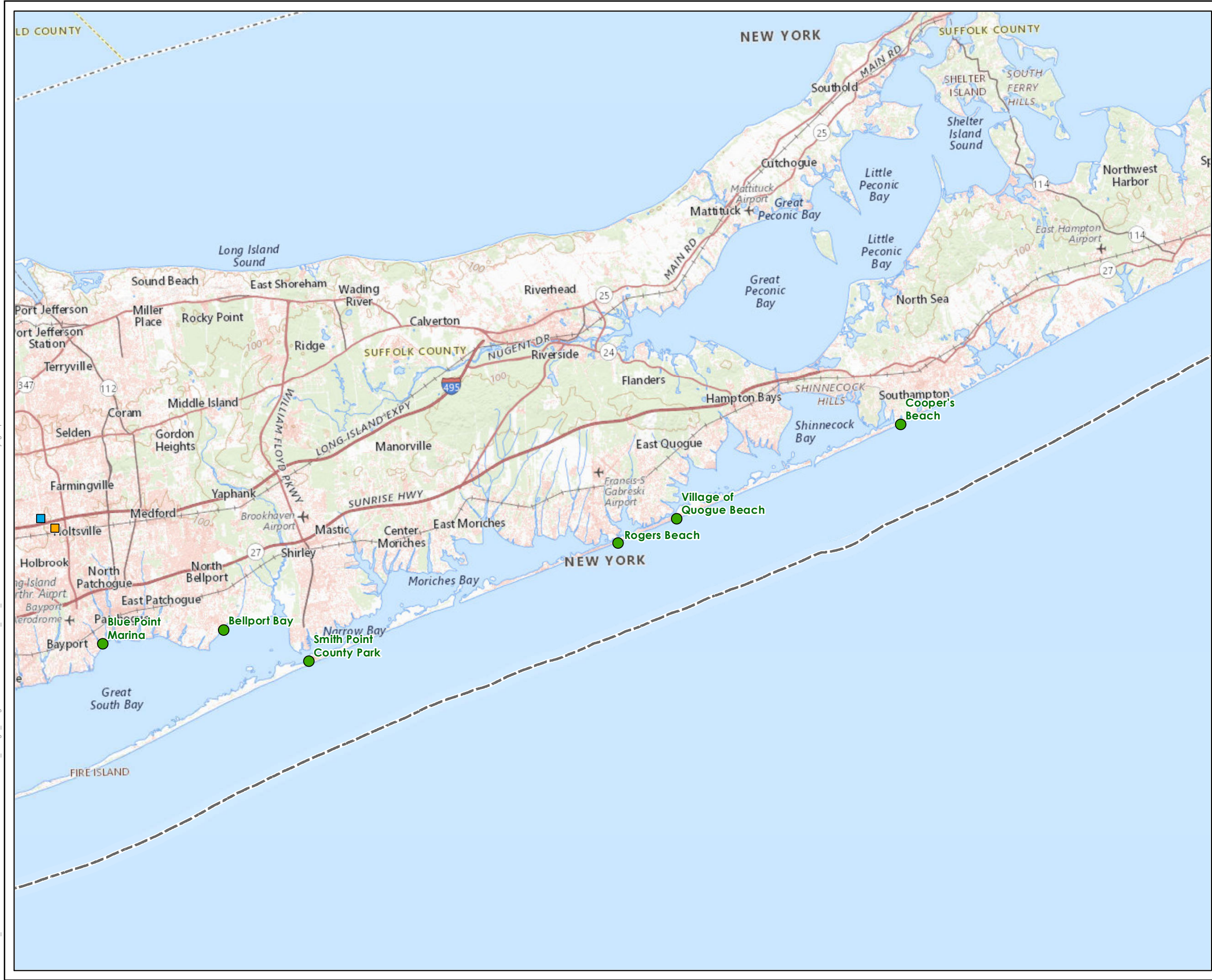

V:\1956\active_Task Owner and other Non-BC\1956_Jobs\2028113199\03_data\gis_ced\gis\Map\XDs\COP\2028113199_2.2-2_LandfallAlternatives.mxd Revised: 2021-05-07 By: gcarpentier

Figure 2.2-2
Landfall Site Alternatives

Sunrise Wind | Powered by Ørsted & Eversource

- Legend**
- Potential Landfall Location
 - Onshore Converter Station (OnCS-DC)
 - Holbrook Substation
 - - - 3-nm State Waters Boundary

Sources
1. Base map: USGS The National Map

Date	09/01/2020 Revised: 12/18/2020
Project Number	2028113199
Prepared By	GC
Reviewed By	LJ

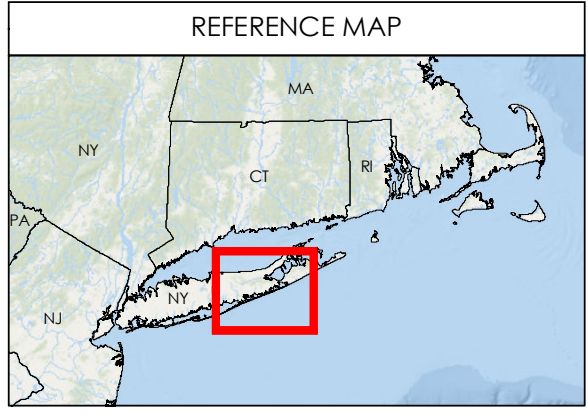
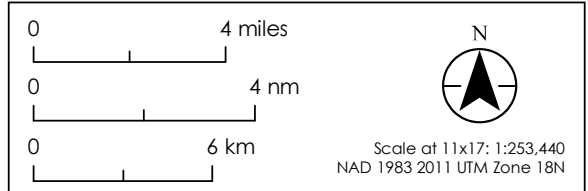

This page intentionally left blank

CONSTRUCTION AND OPERATIONS PLAN

Project Siting and Design Development – Project Alternatives

Table 2.2-2 Summary of Landfall Sites Evaluated

Landfall Site		Constraints Identified
1	Smith Point County Park, Town of Brookhaven, NY	Site advantageous because of anticipated suitable offshore geology and onshore workspace; distance from existing sand borrow areas, mapped shipwrecks or obstructions and recreational boating activity; minimal impacts on natural resources.
2	Village of Quogue Beach, Town of Southampton, NY	Site excluded from further consideration based on limited areas available for temporary work areas; floodplains, significant coastal fish and wildlife habitat; and extended length of Onshore Transmission Cable.
3	Coopers Beach, Southampton, NY	Site excluded from further consideration based on potential conflicts with existing sand borrow areas, and recreational boating activity; proximity to cultural and historic resources; and extended length of Onshore Transmission Cable.
4	Rogers Beach, Westhampton, NY	Site excluded from further consideration based on close proximity to residential areas; limited area available for temporary work areas; and potential conflicts with existing sand borrow areas and recreational boating activity.
5	Bellport Bay, Town of Brookhaven, NY	Sites excluded from further consideration based on adjacent land uses; proximity to federally designated wilderness area and federal navigation channels; and potential conflicts with commercial and recreational fishing activities.
6	Bluepoint Marina/Corey Beach, Town of Brookhaven, NY	

The Village of Quogue Beach, Coopers Beach, and Rogers Beach landfall sites were excluded from further consideration as additional evaluation determined that these routes would result in greater seabed and/or terrestrial disturbance due to increased length of transmission route and/or conflicts with existing anthropogenic constraints and uses. The Bellport Bay and Bluepoint Marina/Corey Beach landfall sites were excluded from further consideration based on potential regulatory and stakeholder concerns about proximity to a federally designated wilderness area and recreational and commercial fishing activities within Great South Bay.

Based on this analysis, Sunrise Wind identified Smith Point County Park as the preferred landfall site for the SRWEC, as described in Section 3.0. This site provides sufficient area to accommodate onshore horizontal directional drilling (HDD) operations within developed areas, with minimal disruption to adjacent land uses, and minimizes direct disturbance to natural or cultural resources in the nearshore, coastal, and intracoastal areas.

Onshore Transmission Cable Routing Alternatives

Potential routes for the Onshore Transmission Cable were considered once the OnCS–DC site and landfall site were selected. Identification of a suitable route for the Onshore Transmission Cable must consider a variety of factors including:

- Maximum use of existing linear corridors and existing ROWs while also minimizing the length of the transmission line and constructability and engineering conflicts;
- Minimal effects to sensitive environmental resources; and
- Minimal conflicts with other land uses, and human/social factors.

CONSTRUCTION AND OPERATIONS PLAN

Project Siting and Design Development – Project Alternatives

Based on the selection of the Union Avenue Site for the OnCS–DC and Smith Point County Park for the landfall, Sunrise Wind conducted multiple rounds of review to identify potential routes that would be suitable for the Onshore Transmission Cable. Initially, Sunrise Wind completed preliminary review of potential corridors within existing roadway and utility ROWs (e.g., William Floyd Parkway and Transmission Line ROW, Long Island Rail Road [LIRR], Sunrise Highway). This initial review identified characteristics and potential constraints of the potential routes, based on publicly available information and local stakeholder engagement. Factors considered during the evaluation included route length, constructability (e.g., route length, number of roadway and railroad crossings, width of corridor), adjacent land uses (e.g., developed parcels, number of residences, public lands), and proximity to environmental and cultural resources (e.g., streams, wetlands, floodplains, unique habitats, cultural and historic properties). This review was used to reduce the potential number of routes, and for further discussions to solicit stakeholder feedback to identify a preferred route for the onshore cable route.

This evaluation generally considered five routes and two variations, as depicted in Figure 2.2-3. Some sections of these routes are located within the same ROW. The routes were studied using a corridor approach, rather than along a specific centerline. The corridors generally consisted of the extents of public road ROW and are described below.

- **LIE Service Road Route** – From Smith Point County Park, the LIE Service Road Route runs parallel to Fire Island Beach Road within the paved Smith Point County Park parking lot, crossing under the William Floyd Parkway to a recreational area located to the west of the William Floyd Parkway. The LIE Service Road Route is then routed across the ICW and turns north along East Concourse, north along William Floyd Parkway and Surrey Circle, , crosses the LIRR via trenchless crossing. The LIE Service Road Route then turns west along Mastic Boulevard (W), north along Francine Place and crosses Montauk Highway to Revilo Avenue. It continues north along Revilo Avenue crossing Sunrise Highway and then turns west along Victory Avenue. It crosses Carmans River , continues west along Victory Avenue, and turns northwest along Horseblock Road. The LIE Service Road Route then crosses the LIRR at Manor Road to Long Island Avenue, turns west along the LIE South Service Road, continues to Waverly Avenue, and turns south on Waverly Avenue to Long Island Avenue, turns west to Long Island Avenue and continues west to Union Avenue to reach the OnCS–DC. An alternative variation to the LIE Service Road Route was also evaluated:
 - *Nicolls Avenue Variation*, which measures approximately 0.9 mi (1.4 km) long; under this alternative variation, the LIE Service Road Route corridor continues west along the LIE South Service Road to Nicolls Road, and then turns south on Nicolls Road to Union Avenue.
- **Montauk Highway Route** – The Montauk Highway Route initially follows the same route as the LIE Service Road Route, except that the route continues north along William Floyd Parkway and turns west along Mastic Boulevard, turns north along Ashley Place, west along Montauk Highway across Carmans River, crosses Yaphank Creek, turns onto Yaphank Avenue and turns northwest on Horseblock Road, where it converges with the LIE Service Road Route.

CONSTRUCTION AND OPERATIONS PLAN

Project Siting and Design Development – Project Alternatives

An alternative variation to the Montauk Highway Route was also evaluated:

- *William Floyd Parkway to Montauk Highway Variation*, which measures approximately 0.5 mi (0.8 km) long; under this alternative variation, the Montauk Highway Route corridor continues further north along William Floyd Parkway to the intersection with Montauk Highway and turns west along Montauk Highway.
- **Peconic Avenue Route** – The Peconic Avenue Route initially follows the same route as the LIE Service Road Route, but diverts off Horseblock Road at Peconic Avenue and continues west along Peconic Avenue to North Ocean Avenue. The Peconic Avenue Route turns north along North Ocean Avenue, west to Long Island Avenue, and continues west along Long Island Avenue to Union Avenue to reach the OnCS–DC.
- **East Woodside Avenue Route** – The East Woodside Route initially follows the same route as LIE Service Road Route, but diverts off Horseblock Road at East Woodside Avenue. The East Woodside Avenue Route continues west on East Woodside Avenue, turns north along North Ocean Avenue, west along Long Island Avenue to Union Avenue to reach the OnCS–DC.
- **Smith Road Route** – The Smith Road Route initially follows the same route as LIE Service Road Route, but diverts off the William Floyd Parkway at Ranch Drive and continues west along Ranch Drive to Smith Road. The route follows Smith Road north to Montauk Highway. The Smith Road Route turns west on Montauk Highway and proceeds along the same route as the LIE Service Road Route.

Routes and alternative variations evaluated for the Onshore Transmission Cable are depicted in Figure 2.2-3 and Table 2.2-3 summarizes the constraints that were identified for each route.

This page intentionally left blank

V:\1956\active_Task Owner and other Non-BC\1956_Jobs\2028113199\03_data\gis_cad\gis\Map\XDs\COP\2028113199_2.2-3_OnshoreAlternatives.mxd Revised: 2021-05-18 By: gearpentier

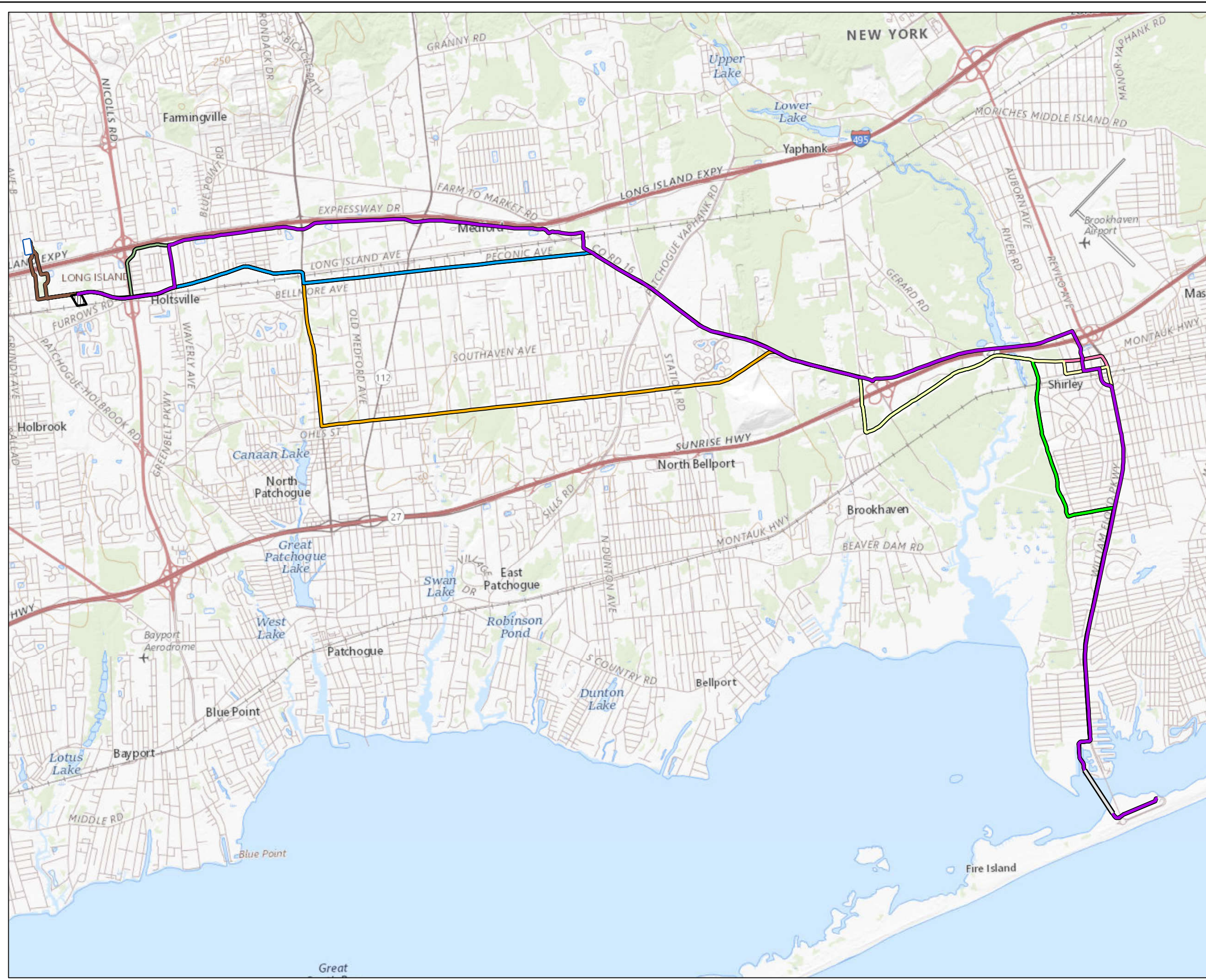

**Figure 2.2-3
Onshore Transmission
Cable Route Alternatives**

**Sunrise
Wind**

Powered by
**Ørsted &
Eversource**

Legend

- Onshore Transmission Cable LIE Service Road Route
- Onshore Transmission Cable Peconic Avenue Route
- Onshore Transmission Cable East Woodside Route
- Onshore Transmission Cable Smith Road Route
- Montauk Highway Route
- William Floyd Parkway to Montauk Highway Variation
- Nicolls Avenue Variation
- Intracoastal Waterway Horizontal Directional Drilling (ICW HDD)
- Union Avenue Site / Onshore Converter Station (OnCS-DC)
- Onshore Interconnection Cable Route
- Holbrook Substation

Note
The cable route centerline and trenchless crossing work areas are indicative and subject to final engineering design.
Sources
Base map: USGS The National Map

Date	12/18/2020 Revised: 6/1/2021
Project Number	2028113199
Prepared By	PB
Reviewed By	LJ

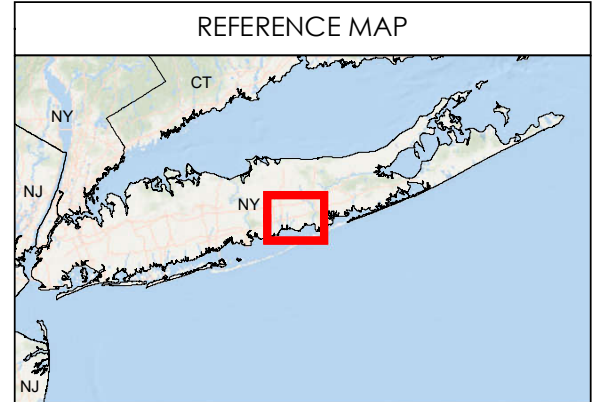
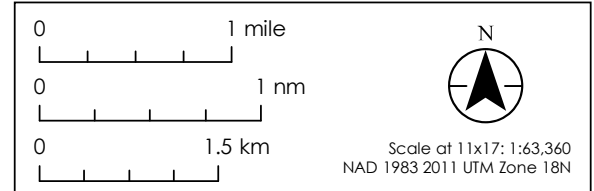

This page intentionally left blank

CONSTRUCTION AND OPERATIONS PLAN

Project Siting and Design Development – Project Alternatives

Table 2.2-3 Summary of Routes Evaluated for Onshore Transmission Cable

Onshore Transmission Cable Routes		Constraints Identified
1	LIE Service Road Route	Route advantageous because of location primarily within existing ROW; minimal presence of sensitive natural resources; limited presence of potential cultural resources; and limited residential impacts.
2	Montauk Highway Route	Route excluded from further consideration based on proximity to sensitive natural and cultural resources, including the Yaphank Creek and the Wertheim National Wildlife Refuge as well as proximity to residences and higher traffic volumes.
3	Peconic Avenue Route	Route excluded from further consideration based on the proximity to residences and narrow road ROW.
4	Woodside Avenue Route	Route excluded from further consideration based on constructability constraints and length of route; proximity to stream and wetlands; and proximity and quantity of residences in some areas.
5	Smith Road Route	Route excluded from further consideration based on proximity to residences; narrow ROW; potential utility conflicts; ownership of underlying land under federal and private control; and proximity to natural resources and historic and cultural resources.

All routes are predominantly along currently paved roads or previously disturbed areas. However, Sunrise Wind identified several technical, commercial, stakeholder, cultural and environmental constraints with the Montauk Highway Route, Peconic Avenue Route, Woodside Avenue Route, and Smith Road Route. Based on this analysis, Sunrise Wind excluded these from further consideration. Additionally, the alternative variations were not selected to avoid certain intersections located along the route, due to permitting and/or traffic impacts, specifically the William Floyd Parkway and Montauk Highway intersection and the LIE South Service Road entry and exit ramps along Nicolls Road.

For these reasons, Sunrise Wind selected the LIE Service Road Route for the Onshore Transmission Cable, as depicted on Figure 1.1-2, and discussed further in Section 3.3.2.

2.2.1.2 Sunrise Wind Export Cable

Sunrise Wind completed a desktop evaluation between the Lease Area and Long Island, NY, to review potential locations for the SRWEC. The constraints considered in the analysis included the potential AC booster station location, the USCG Atlantic Coast Port Access Route Study (ACPARS), automatic identification system (AIS) and vessel monitoring system (VMS) traffic, mapped geology, shipwrecks, artificial reefs, sand borrow pits, existing cables, and other mapped resources. The SRWEC route was selected after considering all of these constraints, which are discussed further below.

The initial routing study conducted in the early part of the Project design phase considered both AC and DC transmission technologies. The AC option included an AC booster station, a single above-water structure located approximately half-way along the export cable, which would have been required to stabilize the voltage and minimize electrical losses along an AC export cable. The siting process of the AC booster station balanced electrical requirements with efforts to reduce potential visual and navigation impacts and influenced the siting of the SRWEC (Figure 2.2-4).

CONSTRUCTION AND OPERATIONS PLAN

Project Siting and Design Development – Project Alternatives

The USCG has commenced rulemaking related to the ACPARS to evaluate routes between Atlantic coast port approaches and international entry and departure transit lanes. An initial ACPARS report included the identification of suitable navigation corridors and recommendations to develop fairway regulations using the navigation corridors as a starting point (USCG 2016). The report included a Tug and Tow Lane, which runs along the coast of Long Island, and a Tug and Tow Extension Lane, which runs diagonally between the end of the proposed Tug Tow Lane and a Deep Draft Lane off the coast of New Jersey. The potential tug and tow lanes were considered when evaluating future vessel traffic scenarios related to SRWEC and AC booster station siting.

Sunrise Wind also evaluated recent AIS and VMS data and navigational features, including identifying high vessel density areas and existing routes where multiple vessels regularly utilize a similar passage and assessed potential future scenarios of vessel traffic based on the establishment of the ACPARS tug and tow lanes.

Based on this evaluation, a SRWEC route was identified that supported both AC and DC options. The SRWEC corridor was then further modified based upon the desktop analysis findings on mapped geology, shipwrecks, artificial reefs, sand borrow pits, existing cables, and other mapped resources. Previously considered SRWEC route alternatives are depicted in Figure 2.2-4.

AREA TO BE AVOIDED
 In order to significantly reduce the risk of ship strikes to the highly endangered North Atlantic Right Whale, ships of 300 gross tons and above should avoid the area between the period of April 1st through July 31st. Reference IMO Sn/Circ. 272.
 Where the boundary of the Area to Be Avoided (ATBA) is co-linear with the boundary of the Traffic Separation Scheme or the boundary of the Mandatory Ship Reporting Area, it has been offset slightly for clarity.

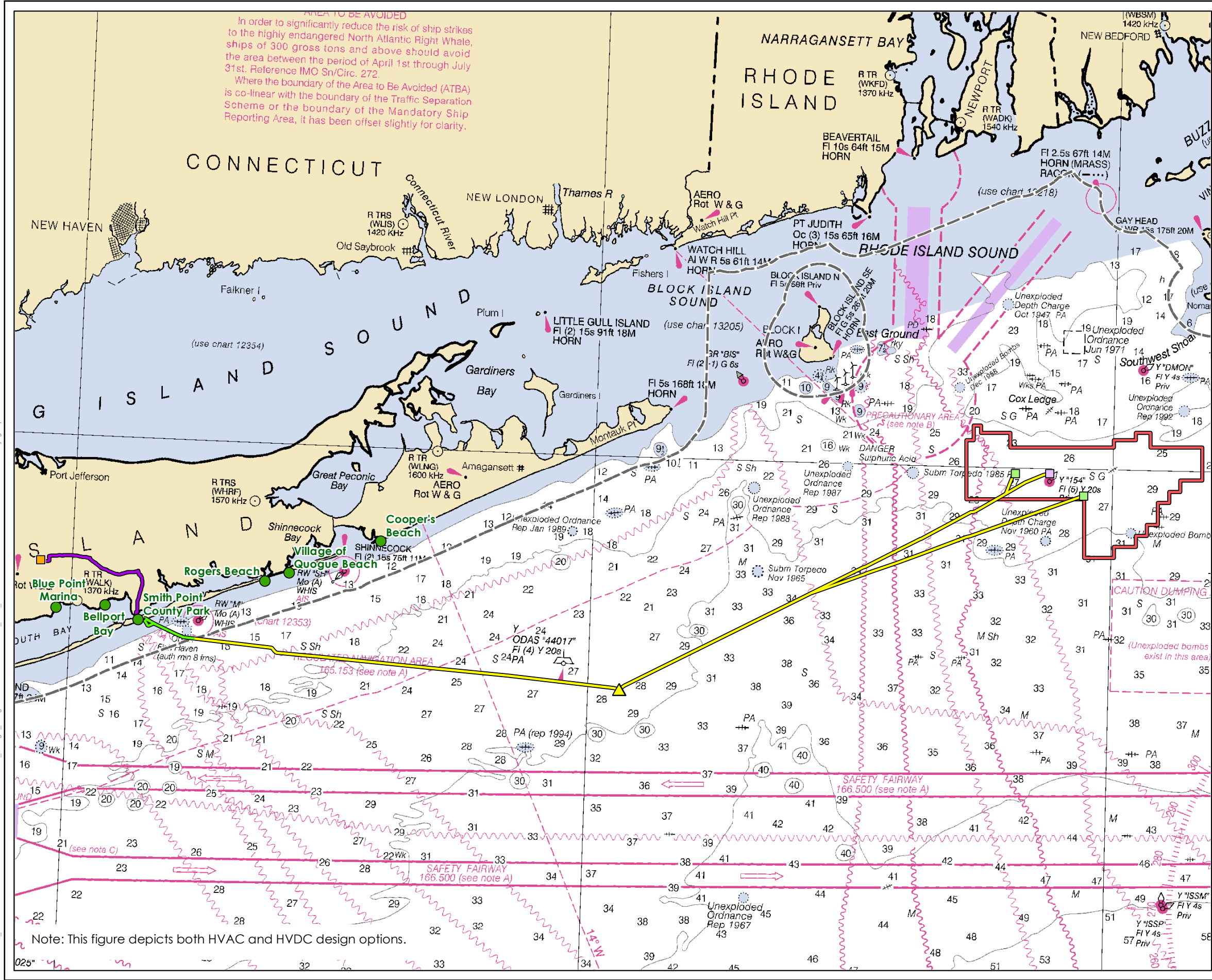

Figure 2.2-4
SRWEC and AC Booster
Station Alternatives

Sunrise Wind | Powered by Ørsted & Eversource

Legend

- Sunrise Wind Farm (SRWF)
- Offshore Substation (OSS-AC)
- Offshore Converter
- Station (OCS-DC) or OSS-AC
- ▲ AC Booster Station Site 1
- Potential Landfall Location
- Onshore Substation (OnSS-AC)/Onshore Converter Station (OnCS-DC)
- Sunrise Wind Export Cable (SRWEC-OCS) Alternatives
- Sunrise Wind Export Cable (SRWEC-NYS)
- Onshore Transmission Cable
- LIE Service Road Route
- 3-nm State Waters Boundary

Note
 Routes are indicative and subject to engineering design changes.

Sources
 1. Base map: NOAA Nautical Chart 13006 West Quoddy Head to New York.

Date	12/18/2020 Revised: 6/1/2021
Project Number	2028113199
Prepared By	PB
Reviewed By	LJ

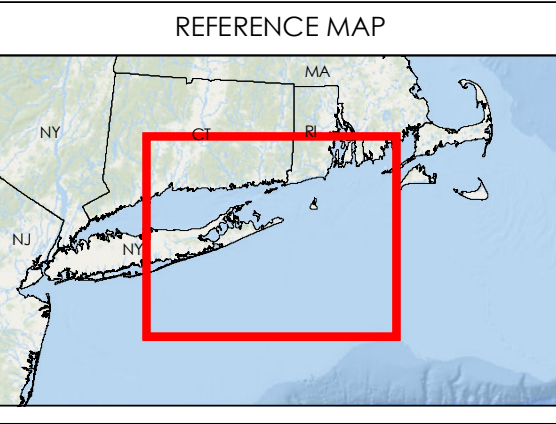
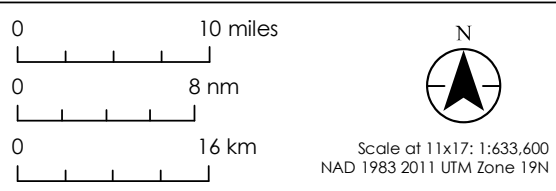

Note: This figure depicts both HVAC and HVDC design options.

V:\1956\active_Task Owner and other Non-BC1956 Jobs\2028113199\03_data\gis_cad\gis\mxd\COP2028113199_2.2-4_OffshoreAlternatives.mxd Revised: 2021-05-07 By: gcarpentier

This page intentionally left blank

CONSTRUCTION AND OPERATIONS PLAN

Project Siting and Design Development – Project Alternatives

2.2.1.3 Sunrise Wind Farm

Generally, the offshore location of the Project is fixed in that the WTGs, IAC, and OCS–DC must be located within the BOEM-designated Lease Area. However, Sunrise Wind evaluated different WTG layouts within the Lease Area in an effort to satisfy the following criteria:

- Maximize use of available space of the Lease Area;
- Maximize use of available wind resources and energy production;
- Minimize interference with commercial and recreational use of the Lease Area and avoid and/or minimize interference with navigation and search and rescue operations, in accordance with the USCG Massachusetts and Rhode Island Port Access Route Study (USCG 2020);
- Avoid and/or minimize impacts to sensitive biological habitat and cultural marine resource sites; and
- Minimize impacts to other sensitive environmental receptors in the surrounding area.

The location for the OCS–DC within the array was influenced by electrical constraints on the number of WTGs that can be connected to a single IAC. The IAC layout is driven by the location of the OCS–DC, WTG layout, and seabed constraints (e.g., boulders). Three WTG layout alternatives were considered relative to these criteria: a Non-Orthogonal Array Layout, a Variable East-West Layout, and an Aligned Grid Layout.

- **Non-Orthogonal Array Layout.** The WTGs in this layout are positioned in an “optimized” array format commonly used in European developments. In this type of array, the WTGs are positioned to minimize wake effects such that energy production is maximized. As a result, the spacing appears to be randomized. Because this layout maximizes efficiency, it can significantly decrease the cost of energy production, resulting in significant savings for local ratepayers.
- **Variable East-West Layout.** The WTGs in this layout are positioned along east-west corridors as necessary to maintain optimization and minimize wake loss. North-south spacing between each east-west row would be 1.15 mi (1 nm, 1.8 km). Within the east-west rows, WTGs would have an average spacing of 0.8 mi (0.7 nm, 1.3 km), and a minimum of 0.7 mi (0.6 nm, 1.1 km).
- **Aligned Grid Layout.** The WTGs in this layout are sited in a uniform east-west/north-south grid with in a 1.15 mi (1 nm x 1 nm, 1.8 km x 1.8 km) spacing that aligns with other proposed adjacent offshore wind projects proposed in the RI-MA WEA and MA WEA. In accordance with 30 CFR § 585.634(c)(6), micrositing of WTG foundations may occur within a 500-ft (152-m) radius around each proposed WTG location. This micrositing will be performed on a case-by-case basis to avoid significant seabed hazards such as surface and subsurface boulders.

The Non-Orthogonal Array Layout and Variable East-West Layout offered several advantages and certain challenges for the Project. While these layouts offer increased micrositing flexibility, engagement with stakeholders, including federal and state regulatory agencies and the maritime community, highlighted that these layouts posed potential challenges for ensuring safe navigation by fishing vessels.

CONSTRUCTION AND OPERATIONS PLAN

Project Siting and Design Development – Project Alternatives

In November 2019, Orsted, Eversource, Vineyard Wind, Equinor, and Mayflower Wind submitted a collaborative letter to the USCG, which proposed a uniform 1 x 1 nm wind turbine layout for the New England WEA¹². As such, Sunrise Wind proceeded with Project development activities based on an Aligned Grid Layout. While this layout reduces the overall efficiency, it increases the overall footprint of the SRWF within the Lease Area. It addresses concerns from regulatory agencies and the maritime community, and still allows for commercially feasible development of the Lease Area. The Aligned Grid Layout maintains some flexibility for micrositing to address the constraints associated with the Lease Area's heterogeneous seabed. For these reasons, the Aligned Grid Layout was selected as the WTG layout for the Project and is further described in Section 3.2.

2.2.2 Design Alternatives

From a design perspective, Sunrise Wind considered alternative transmission cable technology, WTG sizes, and foundation types for WTGs and the OCS–DC. These design alternatives are discussed in the following subsections.

2.2.2.1 Transmission Cable Technology

Sunrise Wind had been considering both an AC and DC option for the Project's transmission system and has finalized its selection of the DC option. Sunrise Wind has performed analysis on both options and has worked closely with several suppliers and determined the DC option is not only viable, but preferable. Due to the length of the Project's transmission system, a DC option provides a more efficient electrical design that will reduce losses – providing a more effective transmission system for the Project. The DC system is also expected to result in greater overall grid stability when compared to an AC system due to the way a DC system is able to decouple any electrical disturbances present from the onshore grid to the WTGs and vice versa. As an added benefit, the DC system will also reduce the number of Project components, and will reduce the environmental impacts from the Project compared to an AC solution.

¹² The November 2019 agreement for the New England WEA was based partially on a study of historic vessel transit patterns in the region that analyzed a uniform 1 x 1 nm layout using vessel safety guidelines (W.F. Baird & Associates Ltd., 2019). This study determined that most traffic in the general region is transiting around, or along the outside edges of, the New England WEA; most transiting vessels are fishing vessels that follow a wide range of transit paths; vessels up to 400' length can safely operate within a 1 x 1 nm layout, and longer vessels tend to follow existing Traffic Separation Schemes outside the New England WEA.

CONSTRUCTION AND OPERATIONS PLAN

Project Siting and Design Development – Project Alternatives

An AC transmission system would include an offshore substation (OSS-AC), or two OSS-AC connected by an inter-link cable, to collect the power generated by the WTGs, transform it to a higher voltage for transmission, and transfer the electricity to the onshore electrical infrastructure via two export cables and a booster station (see Figure 2.2-4 for considered alternatives). Due to the distance from the OSS-AC to the onshore substation (OnSS-AC), the AC transmission system would also require reactive compensation to stabilize the voltage and minimize electrical losses along the export cables. Thus, a booster station would be required, located approximately midway between the OnSS-AC and the OSS-AC. The booster station would be of similar size as the OSS-AC. The offshore DC transmission system only includes one Offshore Converter Station (OCS-DC), one distinct cable bundle, and does not require a booster station to reach the Onshore Converter Station (OnCS-DC).

Because two distinct buried subsea export cables are required for the AC transmission system, whereas the DC transmission system only requires a single cable bundle, the impacts resulting from the construction, O&M, and decommissioning of two AC export cables would be greater than those resulting from the single DC export cable bundle. The total length of an AC export cable corridor would also be greater than the DC export cable corridor if two OSS-AC were to be utilized, and an OSS-Link cable would be required to connect the two OSS-AC.

The booster station required for an AC transmission also creates additional impacts that are avoided by the DC transmission system. Although Sunrise Wind conducted a thorough assessment to identify a suitable location for a booster station, the structure would result in impacts that are avoided by the use of a DC transmission system.

Onshore, the AC transmission system would include transmission cables (two circuits of three cables each within a duct bank of roughly 4 ft width), an OnSS-AC, and interconnection cables connecting the OnSS-AC to the transmission grid (two circuits of six cables each). The DC transmission system would consist of two cables within a single duct bank of roughly 3 ft width, an OnCS-DC, and interconnection cables of similar size as the AC system. The AC system would require a pair of cable splice vaults approximately every 2000 ft, whereas the DC system would require only one splice vault at that same distance. The OnCS-DC has a similar fenced footprint size as an OnSS-AC, but a taller enclosure height than an OnSS-AC.

Based on the above technical and environmental considerations, Sunrise Wind has determined that a DC transmission system is most appropriate for the Project to meet its purpose and need.

2.2.2.2 Wind Turbine Generator Models

Sunrise Wind considered multiple offshore WTG models based on various sizes that are commercially available, and rapidly evolving technology. WTG models ranging in nameplate capacity of 8 to 15 MW were evaluated based on environmental, technical, and commercial suitability for the Project.

CONSTRUCTION AND OPERATIONS PLAN

Project Siting and Design Development – Project Alternatives

2.2.2.3 Foundation Designs

Criteria for the evaluations of foundation alternatives for the WTGs and OCS–DC included the following:

- Size of WTG and OCS–DC platform selected (i.e., foundation needed to be able to support both the proposed minimum and maximum sized WTG);
- Fabrication and installation requirements;
- Maturity of supply chain and procurement approach;
- Environmental risks (e.g., soil/seabed conditions, metocean conditions); and
- Cost.

Five alternative foundation designs were considered:

- **Monopile**, which consists of a single tubular steel foundation that is driven into the soil, upon which a Transition Piece may be placed;
- **Piled Jacket**, which is formed with a steel lattice construction (comprising tubular steel members and welded joints) fixed to the seabed by means of hollow steel pins attached to the jacket. Three- or four-legged jackets were considered for WTGs, and four- to eight-legged jackets were considered for the OCS–DC;
- **Suction Bucket Jackets**, which is similar to the piled jacket, and formed from steel lattice construction. Instead of piles, the suction bucket jacket uses pre-attached (welded) up-down bucket structure, which is secured into the seabed via suction.
- **Monopod Suction Caisson**, which consists of a monopile-type structure that is welded to the top of a single suction caisson; and
- **Gravity Base Structure**, which is generally comprised of solid or hollow concrete caissons with a circular or cruciform shaped base, and a flat-based or conical profile.

These foundation designs are depicted in Figure 2.2-5.

CONSTRUCTION AND OPERATIONS PLAN

Project Siting and Design Development – Project Alternatives



Monopile



Piled Jacket



Monopod Suction Caisson

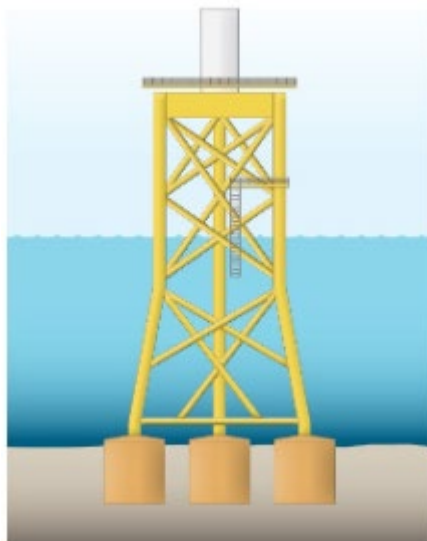

Suction Jacket Bucket

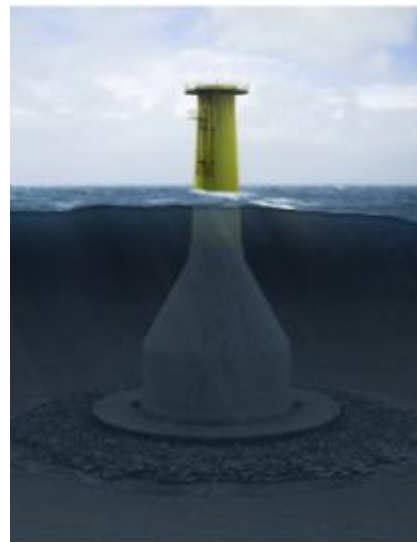

Gravity Base Structure

Figure 2.2-5 Alternative Foundation Concepts for WTG and OCS–DC

In addition to these foundation types, floating platforms have also been identified as possible options. Floating platforms are still in the prototype development stage and have not been deployed for commercial offshore wind projects. Floating platforms are not considered feasible for the Project, given the prototypical nature of the platform and because the water is not deep enough to justify the additional costs and engineering considerations.

CONSTRUCTION AND OPERATIONS PLAN

Project Siting and Design Development – Project Alternatives

Of the foundation designs considered, the monopod suction caisson, suction bucket jacket, and gravity base structure foundation alternatives would not require impact pile driving, which generates underwater noise that may impact marine life. However, there are several other environmental, technical, and commercial challenges associated with utilizing these options for the Project's foundations, including:

- A larger footprint, resulting in greater long-term impact on the seabed than other alternatives;
- Potentially limited suitability for site-specific conditions found within the Lease Area (e.g., water depth, geological substrate, boulders); and
- The supply chain is not mature enough at the present to make these options cost effective.

While these foundation types would not require impact pile driving, they would increase seabed disturbance area, are more difficult to site due to the requirement for a large level area with no boulders, and would create less room for fishing activities between turbines when compared to monopile or piled jacket foundations. Moreover, site preparation and dredging activities could increase environmental impacts when compared to monopile or piled jacket foundations. Overall, these alternative foundation types are not feasible for the Project.

For these reasons, Sunrise Wind has eliminated the monopod suction caisson, suction bucket jacket, and gravity base structure foundation designs from further consideration for this Project. Monopile and piled jacket foundations are a proven technology for offshore WTGs and offshore platforms (such as the OCS-DC) and represent commercially available, mature technological solutions that may be appropriate for the site-specific conditions in the Lease Area. Although monopile foundations have been used for offshore platforms in wind farms in Europe, Sunrise Wind has eliminated the monopile foundation from further consideration for the OCS-DC due to the topside size and weight, water depth, and equipment sensitivity, which require a stiffness of the support structure that can only be achieved by means of a jacket foundation. That said, jacket foundations require a custom-made jacket to match the seabed and water depth at the siting location; thus, the logistics for construction and transportation of jacket foundations can be significant. As such, a piled jacket foundation has been selected for the OCS-DC, but has been ruled out for the WTGs. The PDE, described in Section 3.0, therefore includes only the monopile foundation design for the WTGs and the piled jacket foundation design for the OCS-DC.

2.2.3 Construction Alternatives

Sunrise Wind considered various alternatives for installation of the Onshore Transmission Cable, the submarine cables (i.e., the SRWEC and IAC), and foundations. Construction alternatives related to installation of these Project components are discussed in the following subsections.

CONSTRUCTION AND OPERATIONS PLAN

Project Siting and Design Development – Project Alternatives

2.2.3.1 Onshore Transmission Cable and Onshore Interconnection Cable Installation Methods

Sunrise Wind considered various options for installation of the Onshore Transmission Cable and Onshore Interconnection Cable, including use of above-ground structures and underground duct banks. Although above-ground installation would minimize construction time and cost, identifying and developing a transmission ROW in this area was not considered practical due to potential siting and permitting requirements. In addition, a buried cable reduces visual impacts and operation and maintenance requirements. Therefore, Sunrise Wind plans to bury the Onshore Transmission Cable and Onshore Interconnection Cable within existing ROWs, where practicable.

2.2.3.2 Submarine Cable Installation Methods

Various options for installation of submarine cables were considered, including placement on the seabed and burial beneath the seabed. Although placement on the seabed would minimize installation time and cost as well as potential sediment disturbance, Sunrise Wind plans to bury the cable beneath the seabed. Burying the cable is a means of protecting it from potential damage caused by various external forces (e.g., fishing equipment, anchors) and minimizing the potential for interference with other marine uses. Burying the cable also minimizes the need for maintenance and associated potential for seabed disturbance. The burial depths are selected to balance the following design criteria: 1) physical conditions; 2) avoidance of physical damage from anchors, vessels, or other equipment that might penetrate the seabed; 3) avoidance and minimization of interference with other marine uses; and 4) to allow heat to flow away from the cable so that the temperature does not exceed the design basis of the cable.

Various installation methods for the SRWEC and IAC were also considered, including hydraulic plow (i.e., jet-plow and controlled flow excavation), mechanical plow, and mechanical dredging (i.e., mechanical cutter and trailing suction hopper dredger). Due to the variability of surface and subsurface seabed conditions, Sunrise Wind may use a combination of cable installation methods to install the cable at the target burial depth. Due to the acentric nature of the DC cable bundle, methods typically used for simultaneous lay and bury methodology (e.g., mechanical plowing) have been unsuccessful for bundled DC cables, as they result in uneven forces on the cable, resulting in damage. Thus, a simultaneous lay and bury methodology cannot be used for the SRWEC.

Sunrise Wind also considered multiple installation methods for the SRWEC at the landfall site, including open trench and HDD methods for the SRWEC at the landfall location. Installation via open cut trench would include jet plowing (i.e., trenching via high pressure seawater) and could be used to bury the cable in the nearshore zone up to the mean high-water line (MHWL) on the beach. In this scenario, either an open cut trench or a short-length HDD (likely with a cofferdam on the beach) would be used to install the cable from the MHWL to a transition vault located at an onshore location. This method is not considered preferable based on impacts to intertidal, beach, and dune habitats during construction, as well as impacts to the Fire Island National Seashore. As such, only a longer-length HDD is under consideration, which will bore under the beach and nearshore area, exiting in deeper water past the MHWL. Section 3.3.3 provides further information on the installation method.

CONSTRUCTION AND OPERATIONS PLAN

Project Siting and Design Development – Summary of Proposed Project

2.2.3.3 Foundation Installation Methods

As described above in Section 2.2.2.3, monopile foundations were selected for the WTGs, and piled jackets were selected for the OCS–DC. The monopile and piled jacket foundation types require tubular steel piles to be driven into the seabed to a target depth of embedment. Sunrise Wind considered two methods for installation of the monopile or pin piles for jacket foundations: impact pile driving and vibratory piling driving. Impact pile driving requires use of a hydraulic hammer to embed foundations into the seabed. Vibratory driven piles have a number of vibratory drivers installed on top of the pile, which apply quick sequences of downward and upward motions to the pile in order to reach target depth of embedment. This method can be used independently of, or in combination with (prior to), impact pile driving to final target depth. Both installation methods are still under consideration; thus, these options are assessed within this COP. Section 3.3.5 provides further information on these methods for foundation installation.

2.3 Summary of Proposed Project

Sunrise Wind identified the sites for the OnCS–DC, Landfall, and the WTG layout for the Project based on the results of the alternative evaluations discussed above. Each of these separate Project component alternative evaluations were considered and, as a whole, define the Project's PDE (Section 1.2) and meet the established purpose of the Project (Section 1.3), which consists of the following:

- OnCS–DC: Union Avenue Site, with Interconnection Cables connecting to the existing Holbrook Substation.
- Onshore Transmission Cable: LIE Service Road route, installed in underground duct banks in existing ROW, to the extent practicable.
- SRWEC: Atlantic shore approach with landfall location at Smith Point County Park, installed via a combination of cable installation methods, with HDD for the landfall; and
- SRWF: Aligned Grid Layout with WTG sited in a uniform east-west/north-south grid with 1.15 mi by 1.15-mi (1 by 1-nm; 1.85 by 1.85-km) spacing, and monopile (WTGs) and piled jacket (OCS–DC) foundations.

Retaining these options allows for greater flexibility as the Project design advances, as technological advances occur, and as supply chain characteristics evolve in the US offshore wind market. Each of these are described in additional detail in Section 3.

CONSTRUCTION AND OPERATIONS PLAN

Description of Proposed Activity – Project Description

SECTION 3 – DESCRIPTION OF PROPOSED ACTIVITY

The following section provides a description of the Project, including the location and schedule and a description of construction, commissioning, O&M, and decommissioning.

3.1 Project Description

3.1.1 Project Location

The proposed facility locations for development of the Project have been selected based on the environmental and engineering site characterization studies that have been completed to date, as part of the ongoing evolution of the PDE. The use of the PDE in the COP is discussed in Section 1.2. The location of Project facilities will be further refined based on final engineering design as well as ongoing and continuing discussions, agency reviews, public input, and the NEPA review process.

A Project overview figure is provided in Figure 1.1-1. The onshore components of the Project will include an Onshore Converter Station (OnCS–DC), Onshore Transmission Cable, Onshore Interconnection Cable, and fiber optic cable, which will be located in the Town of Brookhaven, Long Island, New York (see Section 3.3.2). The offshore components of the Project, including the WTGs, Offshore Converter Station (OCS–DC), and IAC, will be located in federal waters in the SRWF within the Lease Area. The SRWEC will traverse both federal waters (SRWEC–OCS) and state territorial waters of New York (SRWEC–NYS).

During construction, the Project will require support from temporary construction laydown yard(s) and construction port(s). The operation phase of the Project will require support from onshore O&M facilities. Additional detail regarding potential port options being considered is provided in Sections 3.3.9.4 and 3.5.5.

For the purposes of this COP, the Project Area refers to the potential maximum footprint of the facilities including the SRWF, SRWEC, and the Onshore Facilities (OnCS–DC, Onshore Transmission Cable, and Onshore Interconnection Cable).

3.2 Project Infrastructure Overview and Schedule

3.2.1 Project Infrastructure Overview

The design of an offshore wind project requires a number of elements that are designed in consideration of the characteristics of the environment in which they will be located and for the purpose they serve. While much of an offshore wind project is located in the marine offshore environment, the need to interconnect with the existing electrical grid requires that elements are located on land. As described in Section 1.2 relative to and consistent with the PDE concept, Sunrise Wind is considering a range of potential Project design values and construction techniques associated with various components of the Project. The use of a PDE is necessary to accommodate changes in available technology and Project economics, and the outcome of the Project environmental review, design refinements, and approval process that can be accommodated within the Project's final design.

CONSTRUCTION AND OPERATIONS PLAN

Description of Proposed Activity – Project Infrastructure Overview and Schedule

The Project will be comprised of the following offshore and onshore infrastructure:

Onshore:

- Onshore Transmission Cable, TJBs and concrete and/or direct buried joint bays, and associated components;
- Onshore Interconnection Cable;
- Fiber optic cable co-located with the Onshore Transmission and Onshore Interconnection Cables; and
- One Onshore Converter Station (OnCS–DC).

Offshore:

- Up to 122 WTGs;
- Up to 123 foundations (for WTGs and an OCS–DC);
- Up to 186 mi (300 km) of IAC;
- One Offshore Converter Station (OCS–DC); and
- One SRWEC located within an up to 106-mi (170-km)-long corridor.

An overview of the Project location, and schematic overview of the Project infrastructure are provided in Figure 3.2.1-1 and Figure 3.2.1-2 respectively. Section 3.3 provides additional detail on each of the Project components, including the various design and construction parameters under consideration.

V:\1956\active_Task Owner and other Non-BC1956 Jobs\2028113199\03_data\gis_cad\gis\Map\KDs\COP\2028113199_3.2.1-1_ProjectOverview.mxd Revised: 2021-05-18 By: gcarpentier

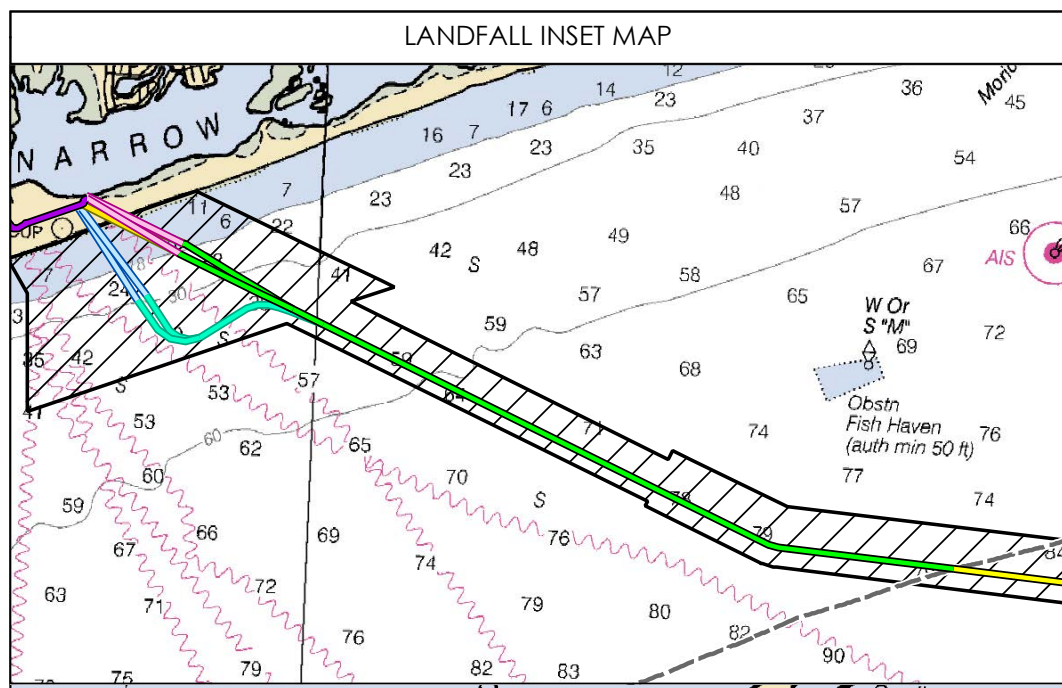
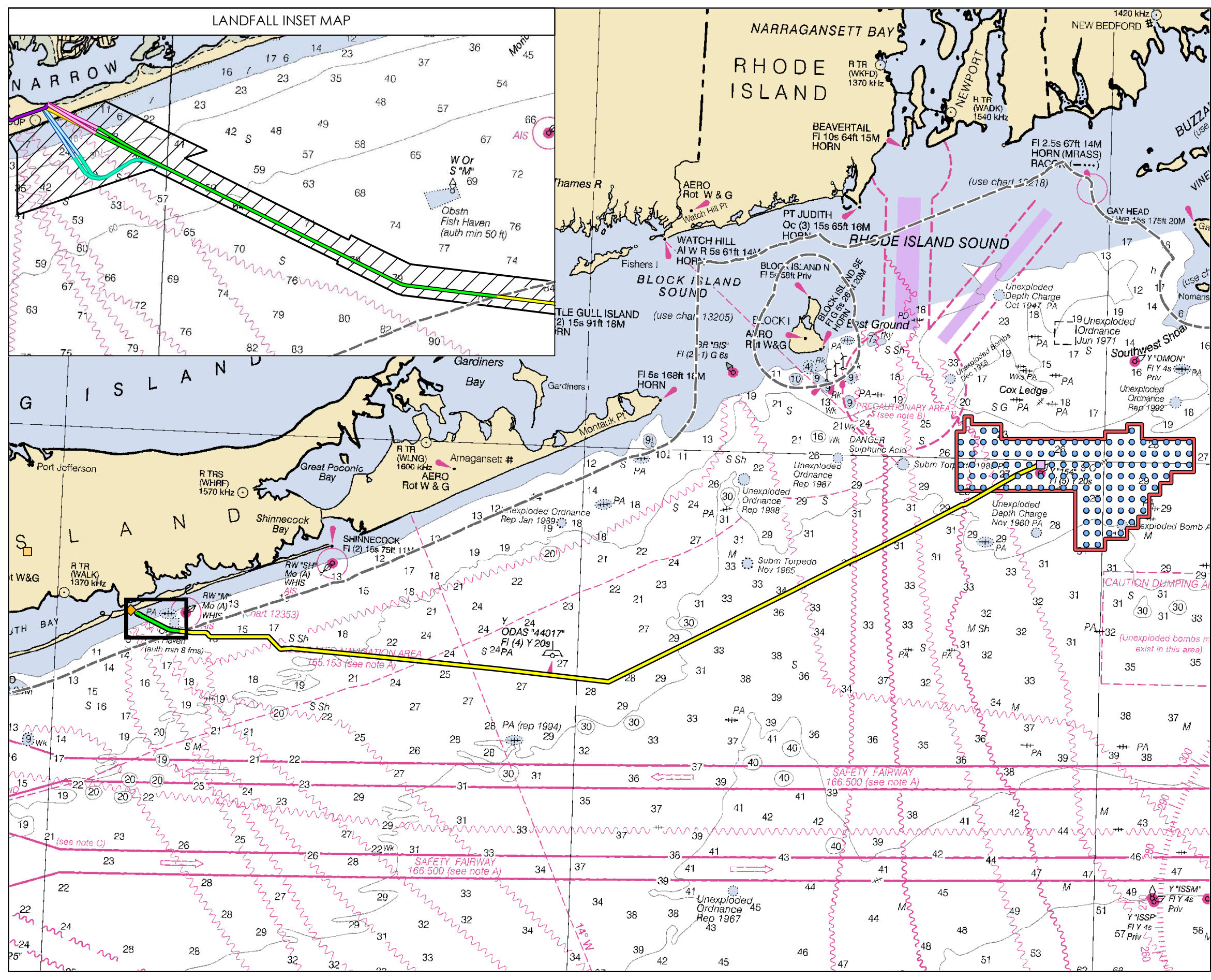

**Figure 3.2.1-1
Project Overview**

Sunrise Wind | Powered by Ørsted & Eversource

- Legend**
- Sunrise Wind Farm (SRWF)
 - Indicative Turbine Layout (WTG)
 - Offshore Converter Station (OCS-DC)
 - ◆ SRWEC Landfall Location
 - Sunrise Wind Export Cable (SRWEC-OCS)
 - Sunrise Wind Export Cable (SRWEC-NYS)
 - Onshore Converter Station (OnCS-DC)
 - SRWEC-NYS (Western Landfall Option)
 - Landfall HDD A
 - Landfall HDD B
 - Landfall HDD C
 - Onshore Transmission Cable
 - LIE Service Road Route
 - SRWEC Corridor
 - 3-nm State Waters Boundary

Sources

1. BOEM Outer Continental Shelf Submerged Lands Act Boundary
2. Base map: NOAA Nautical Chart 13006 West Quoddy Head to New York.

Date	12/18/2020 Revised: 6/1/2021
Project Number	2028113199
Prepared By	GC
Reviewed By	LJ

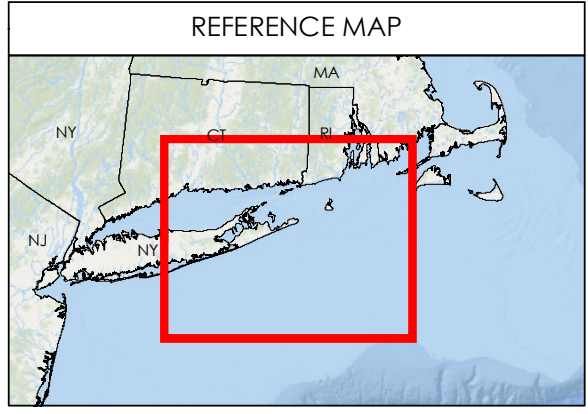
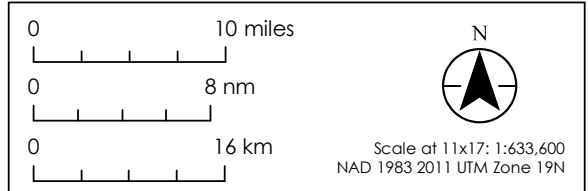

This page intentionally left blank

CONSTRUCTION AND OPERATIONS PLAN

Description of Proposed Activity – Project Infrastructure Overview and Schedule

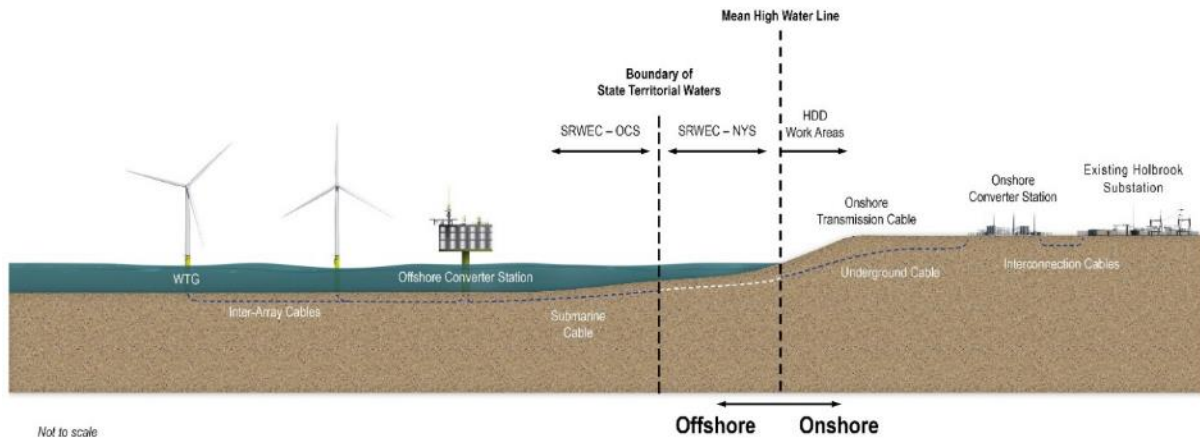

Figure 3.2.1-2 Overview of Project Infrastructure

In addition to the proposed infrastructure, Sunrise Wind is currently investigating existing facilities in New York, Connecticut, Massachusetts, Maryland, New Jersey, Rhode Island, and Virginia for potential use for staging, construction, and/or for O&M purposes. At this time, no final determination has been made concerning the specific location(s) of these activities (see Sections 3.3.10 and 3.5.5).

The following sections provide details regarding the PDE under consideration for each of the major Project components and associated construction processes. The final selections and installation strategies will be reviewed by the CVA and submitted to BOEM prior to construction. BOEM indicated in May 2018 that submittal of a separate FDR/FIR for each component of the Project (e.g., WTGs, OCS-DC) is allowed under the regulations, provided coordination with BOEM is undertaken to concur on approach.

CONSTRUCTION AND OPERATIONS PLAN

Description of Proposed Activity – Project Infrastructure Overview and Schedule

3.2.2 Project Schedule

A high-level indicative construction schedule is provided in Figure 3.2.2-1. The Project will be commissioned and operational by Q4 2025. Sunrise Wind assumes all permits will be obtained by Q3 2023, to allow for final engineering and design, contract negotiations, procurement, and manufacturing prior to installation. It is further assumed construction will begin in Q3 2023, with installation of the onshore components and initiation of seafloor preparation activities (clearing of debris and obstructions). Offshore installation is anticipated to begin in Q2 2024.

Anticipated construction durations (inclusive of commissioning) are summarized below:

- Onshore Facilities (OnCS–DC, Onshore Interconnection Cable, and Onshore Transmission Cable): approximately 2 years;
- SRWEC: approximately 8 months (including 4 months route clearance, and 4 months installation);
- Offshore Foundations (WTG and OCS–DC): approximately 4–5 months;
- IAC: approximately 7 months (including 3 months route clearance and 4 months installation and termination);
- WTGs: approximately 10 months;
- OCS–DC: approximately 12 months;

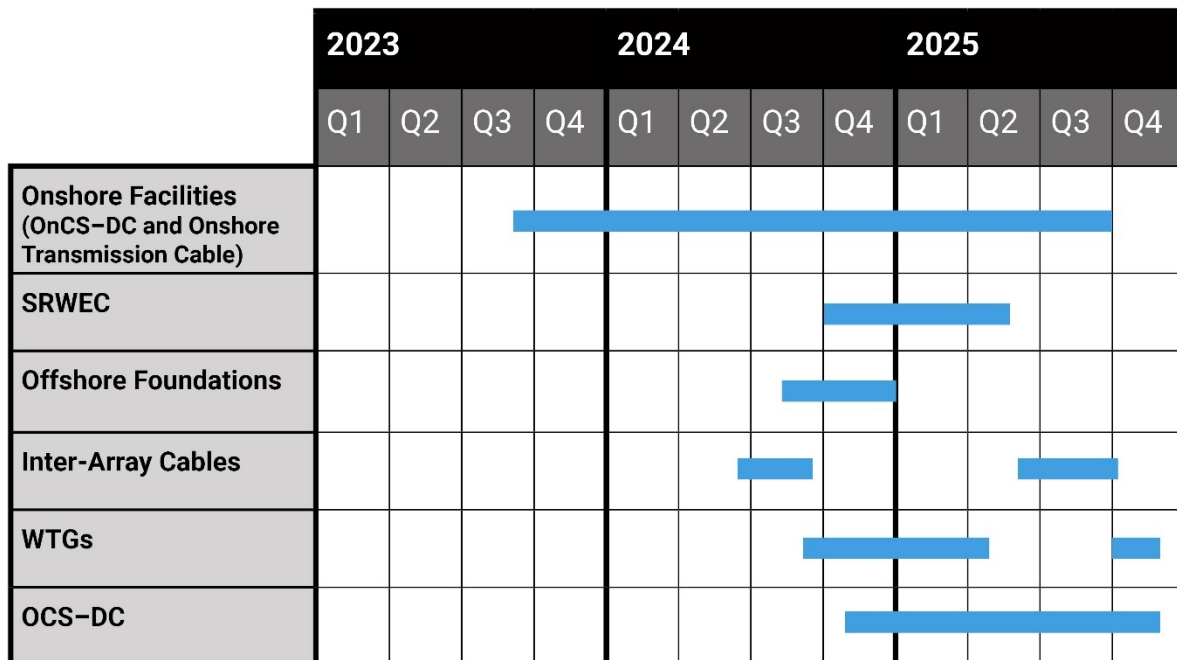

Figure 3.2.2-1 Indicative Project Construction Schedule

CONSTRUCTION AND OPERATIONS PLAN

Description of Proposed Activity – Project Design and Construction Activities

3.3 Project Design and Construction Activities

The following sections describe the proposed Project infrastructure and provide details on design and construction methodologies. Section 3.3 is organized in accordance with the standard construction sequence of an offshore wind farm as outlined in the Project Schedule (see Figure 3.2.2-1) with construction of the onshore components beginning first.

3.3.1 Onshore Converter Station Facilities

Power from the Project will be delivered to the electric grid via an Onshore Converter Station (OnCS–DC), to be constructed in the Town of Brookhaven, Long Island, New York. The OnCS–DC will support the Project's interconnection to the existing electrical grid by transforming the Project voltage to 138 kV AC. Interconnection to the electric grid will occur at the existing Holbrook Substation also located in the Town of Brookhaven, New York.

As discussed in Section 2.0, Sunrise Wind evaluated several locations for the OnCS–DC based on parcel availability, environmental resources, land use and zoning, distance to shore, design requirements, and construction feasibility. The Union Avenue Site was ultimately selected. Located south of Union Avenue in the Town of Brookhaven, New York, this approximately 7-acre (2.8-ha) area is located on two parcels to be improved jointly as a common development. The site is bound to the north by Union Avenue; to the east by commercial development; to the south by the LIRR and commercial development; and to the west by commercial and industrial development. Sunrise Wind is in discussion with the owner regarding acquisition or lease of this property for the Project.

The entire station footprint area will be graveled and surrounded by a 7-ft (2.1-m)-high fence topped with a 1-ft (0.3-m) tall, barbed wire extension for a total height of 8 ft (2.4 m). Access will be provided through a minimum of one drive-through gate and one walk-through gate. Vegetative screening of the site will be provided as needed subject to New York permitting requirements. General yard lighting will be provided within the site for assessment of equipment. In general, yard lighting will be minimal at night and subject to state and local requirements unless there is work in progress on site or lights are required for safety and security purposes.

The Union Avenue Site is depicted in Figure 3.3.1-1. Equipment and structures for the OnCS–DC will be supported on foundations expected to be of concrete and will be of a design suitable for existing soil conditions. The majority of the site equipment will require shallow foundations, 4 to 5 ft (1.2 to 1.5 m) in depth based on the expected equipment size. Larger structures may require drilled shaft equipment foundations of 12 to 30 ft (4 to 9 m) in depth.

The final foundation design and equipment layout may vary based on site-specific geotechnical evaluations and subsequent engineering design.

The OnCS–DC will be equipped with a Supervisory Control and Data Acquisition (SCADA) system. The SCADA interface system provides monitoring, control, and protection of the high voltage and low voltage equipment and auxiliary components. This ensures safe monitoring and control of the windfarm in operation. The protection and control equipment, such as relays and other electronics, will be housed within a control building or encased in secure weatherproof cabinets.

CONSTRUCTION AND OPERATIONS PLAN

Description of Proposed Activity – Project Design and Construction Activities

Onshore Facilities will be designed in accordance with the National Electric Safety Code (NESC), American National Standards Institute (ANSI)/ Institute of Electrical and Electronics Engineers (IEEE) Standards and New York Independent System Operator (NYISO) requirements. Grading at the OnCS-DC will ensure adequate drainage and ensure that the site is graded appropriately to reduce impacts from water accumulation. The design will consider the potential effects of erosion, high winds, and ice. The OnCS-DC is located in the Town of Brookhaven and is well inland of the 100-year and 500-year floodplain and the minimum equipment elevations at the OnCS-DC site exceed both the present day and future worst-case Design Flood Elevation, as recommended in American Society of Civil Engineers (ASCE) 24-14. Because the OnCS-DC is located inland, impacts from sea level rise, storm surge, overland wave propagation, and runup and overtopping hazard would not be expected to affect the OnCS-DC during the lifetime of the Project.

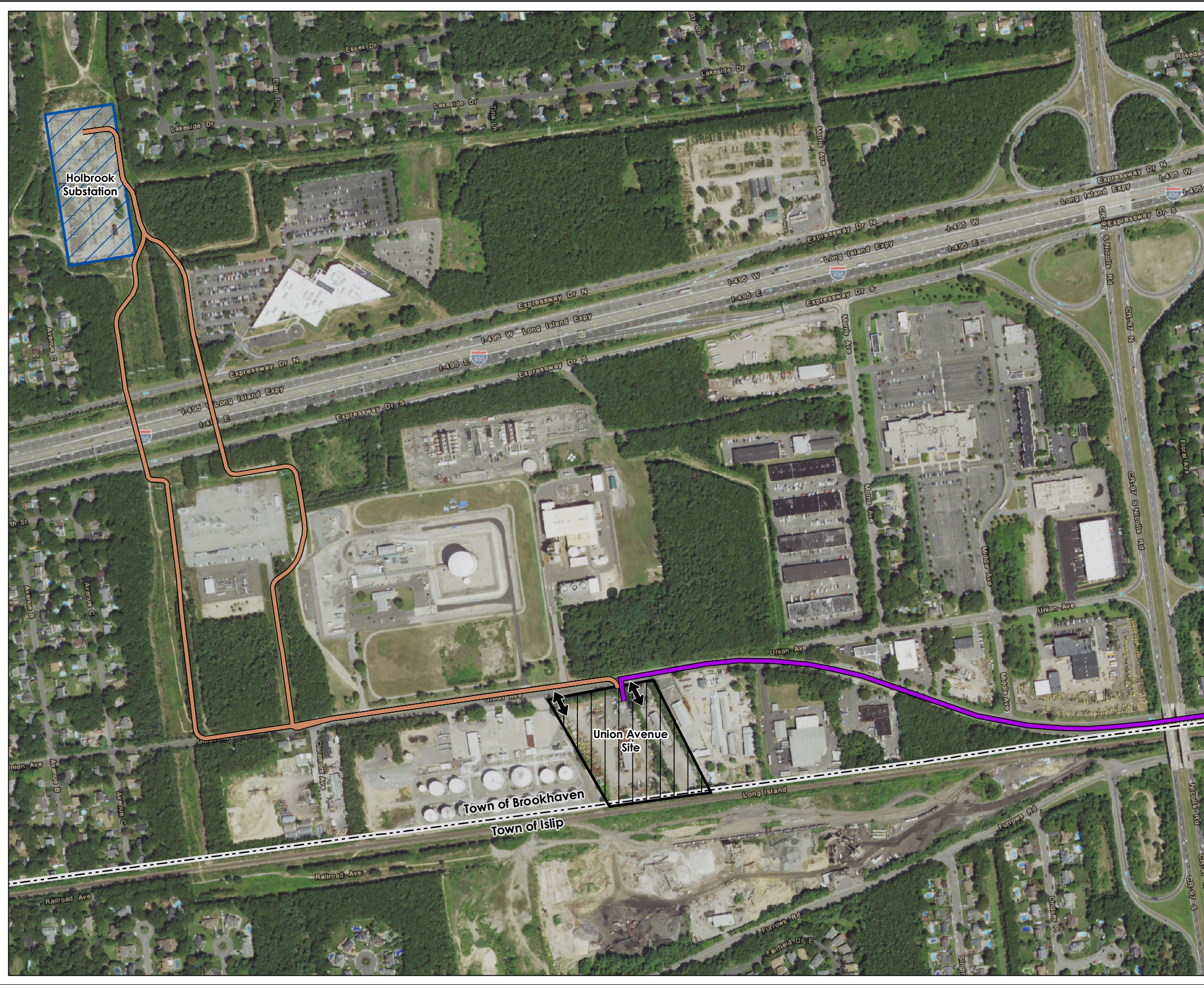

Figure 3.3.1-1
Union Avenue Site and
Onshore Interconnection Cable

Sunrise Wind | Powered by Ørsted & Eversource

Legend

- Sunrise Wind Export Cable (SRWEC-NYS)
- Onshore Transmission Cable
- Onshore Interconnection Cable Route
- Union Avenue Site Access Location
- Union Avenue Site / Onshore Converter Station (OnCS-DC)
- Holbrook Substation
- Town Boundary

Note
 Routes are indicative and subject to engineering design changes.

Sources
 Base map: NAIP 2019

Date	12/18/2020 Revised: 6/1/2021
Project Number	2028113199
Prepared By	GC
Reviewed By	LJ

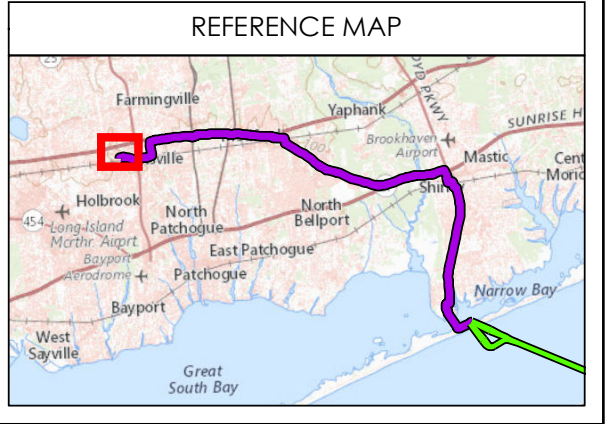
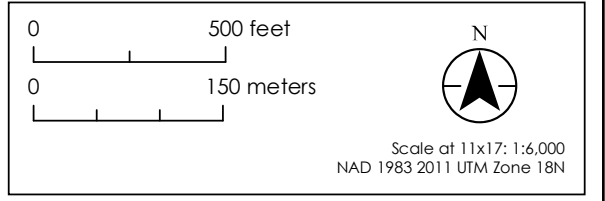

This page intentionally left blank

CONSTRUCTION AND OPERATIONS PLAN

Description of Proposed Activity – Project Design and Construction Activities

3.3.1.1 Design

The OnCS–DC will convert DC power from the Onshore Transmission Cable to AC power at 138 kV. The DC portion of the OnCS–DC will consist of a valve hall and cooling devices, which are unique to the converter design. The AC portion of the OnCS–DC will consist of gas or air insulated switchgear system bay positions using 138-kV equipment.

The OnCS–DC will be equipped with up to two cable termination bays for connection of up to two Onshore DC monopole cables and up to two Onshore AC Interconnection Cable bays to the Holbrook Substation. Major equipment associated with the OnCS–DC is summarized in Table 3.3.1-1. A new control enclosure at the OnCS–DC will be equipped with control systems, as well as systems for local and remote control of the equipment.

Table 3.3.1-1 Onshore Converter Station Equipment

Onshore Converter Station Feature	Maximum Number Required
High-Voltage Shunt Reactor (fixed)	2
High-Voltage Shunt Reactor (variable)	2
High-Voltage Harmonic Filter	2
Gas-Insulated Switchgear Bay	10
Grid Transformer (single phase)	4

The OnCS–DC will require mineral oils and sulfur hexafluoride (SF₆) to support safe and efficient operation of the facility equipment. Table 3.3.1-2 provides a summary of the maximum anticipated volumes. The equipment listed will be mounted on concrete foundations with concrete secondary oil containment designed in accordance with industry and local utility standards. A Spill Prevention, Control, and Countermeasure (SPCC) Plan will be developed in support of SPDES permitting. Additionally, OnCS–DC devices containing SF₆ will be equipped with integral low-pressure detectors to detect SF₆ gas leakages should they occur.

Table 3.3.1-2 Summary of Maximum Potential Volumes, Oils, Fuels, Gas and Lubricants for the Onshore Converter Station

Onshore Converter Station Equipment/System	Oil/Fuel/Gas Type	Total Oil/Fuel/Gas Volume
(2) High-Voltage Shunt Reactor (fixed)	Mineral Oil Dielectric Fluid	26,640 gallons (gal) (100,844 liters [L])
(2) High-Voltage Shunt Reactor (variable)	Mineral Oil Dielectric Fluid	37,000 gal (140,060 L)
(4) 345/275-kV Grid Transformers	Mineral Oil Dielectric Fluid	37,693 gal (107,014 L)
Gas-Insulated Switchgear Bay	Sulfur Hexafluoride (SF ₆)	3,500 lbs

CONSTRUCTION AND OPERATIONS PLAN

Description of Proposed Activity – Project Design and Construction Activities

3.3.1.2 Construction

Construction of the OnCS–DC will involve surveys and protection of sensitive areas, clearing and grading, foundation and equipment installation, site restoration, and commissioning, as described in Table 3.3.1-3. Sunrise Wind may utilize temporary laydown yards to support the staging of necessary equipment and materials for development of the OnCS–DC. Locations selected for the use of temporary laydown yards will be approved by the applicable permitting agencies prior to utilization and Sunrise Wind anticipates that identification efforts at such locations would be conducted under BOEM's process for deferred identification of historic properties. These areas will be generally confined to locations containing open land or previously disturbed commercial/industrial sites with existing roadway access, such that no or minimal site improvements are required. Sunrise Wind will use mechanical clearing methods for the construction of the Project and does not intend to use any pesticides/herbicides during construction and installation. Following the completion of the Project, locations used for temporary laydown yards will be restored to pre-existing conditions in accordance with landowner requests and permit requirements.

Table 3.3.1-3 Typical OnCS–DC Construction Sequence

Stage	Activity/ Action	Construction Details
1	Surveys and Protection of Sensitive Areas	Work at the OnCS–DC site will begin with the survey, staking, and protection of any sensitive areas/services. Access to the work site will then be established, segregated from the public, and the required safety measures will be implemented.
2	Clearing and Grading	The work site will be cleared of vegetation, and temporary environmental erosion controls such as swales and erosion control socks will be installed in accordance with best management practices (BMPs). These controls will be maintained until the site is restored and stabilized. The work site will be graded; the disturbed areas outside of the final site footprint will be restored.
3	Installation	Installation of foundations will require excavation to support construction of stormwater management components and installation of other equipment. Blasting is not expected; however, if required, the appropriate blasting plans and approvals will be obtained prior to any such activity. All the major equipment will be installed upon completion of concrete foundations and cable duct banks. The equipment will be rigged and placed on the concrete foundations. The transport and logistics company who acts as sub-contractor to the equipment manufacturer is responsible for all logistical services, e.g., engineered rigging/skidding and hauling plans, routing, permitting, clearance checking, escort, police escort, load analysis of transport, as well as dimensional restrictions. Upon installation of the equipment on the foundations, earthing and alignment checking will be performed, and when required anchoring and temporary protection from weather will be applied. Upon placing the equipment, a site acceptance test will be undertaken; all attachments will be completed associated with each equipment. When required, the equipment will be filled with insulating fluid and/or insulating gas.
4	Restoration	Restoration of any disturbed areas and appropriate landscaping will be performed, as necessary. Temporary environmental controls will remain (as needed) until the site is stabilized in accordance with permit requirements.

CONSTRUCTION AND OPERATIONS PLAN

Description of Proposed Activity – Project Design and Construction Activities

Stage	Activity/ Action	Construction Details
5	Commissioning	<p>Upon the acceptance testing of the OnCS–DC control center, the commissioning of the OnCS–DC will commence. Prior to energization, all equipment will be tested to confirm proper operation. Energization is a sequential process that energizes the equipment and facilities in a logical order to coordinate with the equipment and system requirements to meet the Project milestones.</p> <p>The testing and commissioning will be performed by qualified testing personnel. The work will be performed in accordance with the applicable industry standards. The commissioning will be performed in strict adherence to the Independent System Operator's protocol on receiving permits and clearances.</p>

The maximum areas of land disturbance associated with the construction of the OnCS–DC are provided in Table 3.3.1-4. Site grading may be between 7 to 10 ft (2.1 to 3.0 m) deep in areas that require excavation but will be further refined as geotechnical work is completed. The anticipated construction timeframe for the OnCS–DC is provided in the construction schedule in Section 3.2.2.

Table 3.3.1-4 Maximum Disturbance Areas for the OnCS–DC Site

Parameter	Maximum Design Scenario
Area Disturbed During Construction (acres) a/	7 acres (2.8 ha)
Operations Site Area b/	6 acres (2.4 ha)
Lightning Mast Height	100 ft (30.5 m)
Enclosure Height	70 ft (21.3 m)
NOTES: a/ Limit of disturbance during construction, inclusive of permanent footprint of the OnCS–DC and temporary disturbance. b/ Permanent footprint of the OnCS–DC facilities.	

3.3.2 Onshore Transmission Facilities

Electrical transmission facilities for the Project will be comprised of both onshore and offshore cable systems. Specifically, power from the SRWF will be delivered to the electric grid via distinct transmission cable segments: the SRWEC and Onshore Transmission Cable will carry the power from the TJB to the existing grid at the Holbrook Substation. The SRWEC and Onshore Transmission Cable will be spliced together at co-located TJBs and link boxes located at Smith Point County Park on Fire Island in the Town of Brookhaven, New York. The SRWEC and Onshore Transmission Cable have different design and construction parameters; therefore, these transmission components are described separately. The Onshore Transmission Cable is described in this section while the SRWEC and TJBs are described in Section 3.3.3.

The Onshore Transmission Cable route has been sited within existing disturbed ROW to the extent practicable. The Onshore Transmission Cable would originate at the TJB on the eastern portion of Smith Point County Park, as described below. The Onshore Transmission Cable would then follow the LIE Service Road Route to the OnCS–DC at the Union Avenue Site.

CONSTRUCTION AND OPERATIONS PLAN

Description of Proposed Activity – Project Design and Construction Activities

The LIE Service Road Route (hereinafter the Onshore Transmission Cable route) will travel up to 17.5 mi (28.2 km) in length to the OnCS–DC as described below and depicted in Figure 3.3.2-1. From the Landfall Work Area, the Onshore Transmission Cable runs parallel to Fire Island Beach Road within the paved Smith Point County Park parking lot, crossing under the William Floyd Parkway to a recreational area located to the west of William Floyd Parkway. The Onshore Transmission Cable is routed across the ICW via the ICW HDD to a paved parking lot within the Smith Point Marina along East Concourse Drive. From the ICW Work Area, the Onshore Transmission Cable turns north along East Concourse and north along William Floyd Parkway to the intersection with Surrey Circle. The Onshore Transmission Cable will be routed along Surrey Circle and will continue north along Church Road then turn west along Mastic Boulevard, north along Francine Place, to the intersection with Montauk Highway. It will cross Montauk Highway to Revalo Avenue and will continue north along Revalo Avenue to the work area for the Sunrise Highway crossing. The Onshore Transmission Cable will then cross Sunrise Highway via trenchless methods to Revalo Avenue, continuing north to the intersection with Victory Avenue and then continue west on Victory Avenue to Horseblock Road, crossing the Carmans River via HDD. The Onshore Transmission Cable will continue northwest along Horseblock Road to Manor Road, then turn north onto Manor Road and cross the LIRR to Long Island Avenue via trenchless methods. The Onshore Transmission Cable turns west along the LIE Service Road, then turns south on Waverly Avenue to Long Island Avenue. The Onshore Transmission Cable then turns west on Long Island Avenue to Union Avenue and reaches the Union Avenue Site.

The Onshore Interconnection Cable will begin at a set of termination structures located at the OnCS–DC and will be routed entirely underground along Union Avenue to an existing utility-owned or controlled property for connection to the Holbrook Substation (Figure 3.3.1-1).

The design of the Onshore Transmission Facilities will take into account geologic and local climatic conditions. The selection of an underground design avoids overhead weather-related disturbances such as from wind, ice, and lightning. The HDD also provides some amount of protection from storm surges, flooding, sea level rise, wave runup, and overland wave propagation. Additionally, the route is almost entirely within existing roadways that are designed for adequate drainage to handle such events, and there would be no change to grading or drainage of those facilities as a result of the Project construction. At the landfall location at Smith Point County Park, storm surge levels are to 13.9 ft (4.2 m), which is inclusive of both the stillwater elevation and wave setup, an increase in water levels caused by wave breaking, along the Atlantic-facing coast (Federal Emergency Management Agency [FEMA] 2009). Within Bellport Bay, storm surge decreases due to the protection of offshore barrier islands.

V:\1956\active_Task Owner and other Non-BC\1956_Jobs\2028113199\03_data\gis_cad\gis\mxd\COP\2028113199_3.3.2-1_OnshoreCables.mxd Revis ed: 2021-05-18 By: gcarpentier

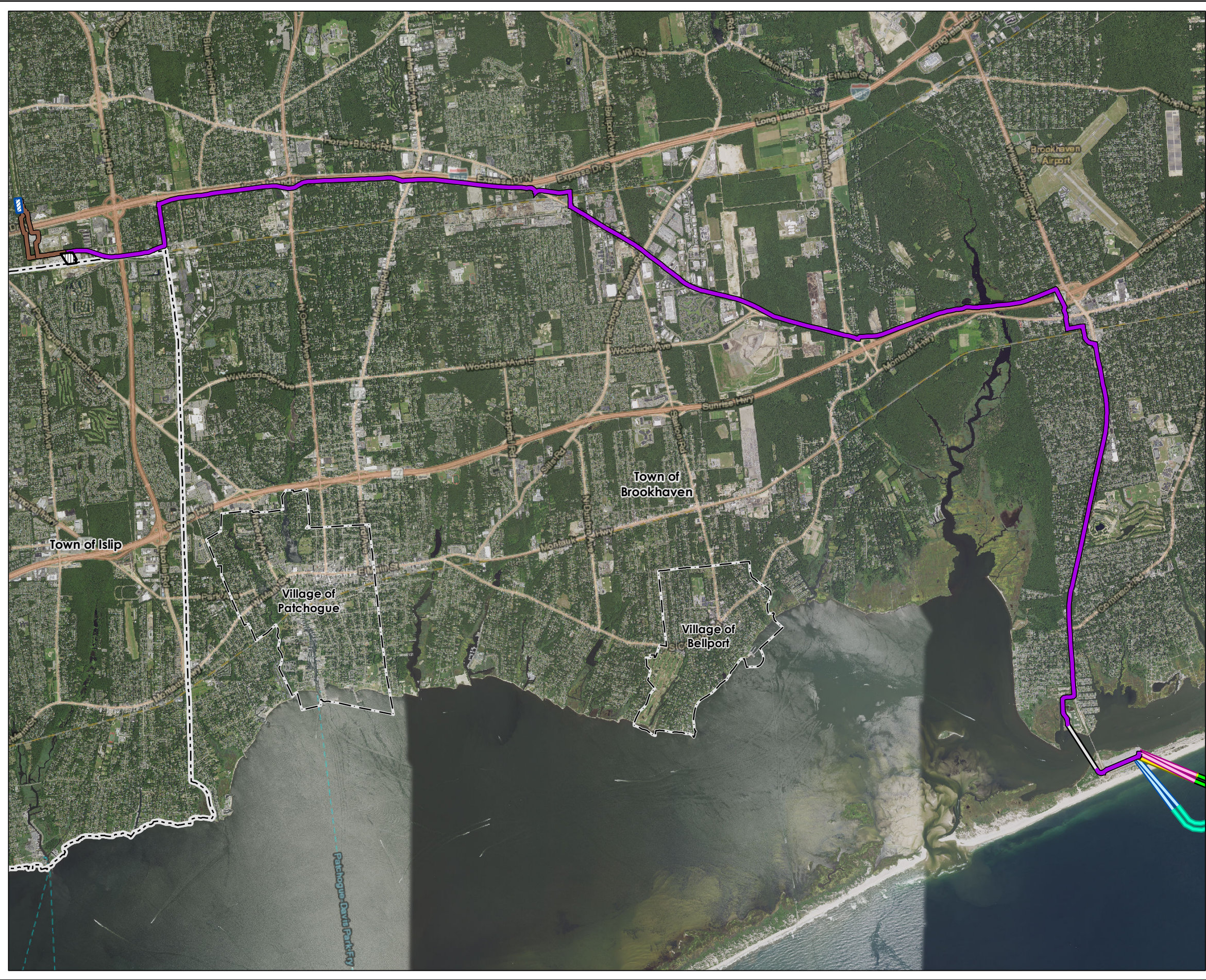

**Figure 3.3.2-1
Onshore Transmission
Cable Route**



- Legend**
- Sunrise Wind Farm (SRWF)
 - Sunrise Wind Export Cable (SRWEC-OCS)
 - Sunrise Wind Export Cable (SRWEC-NYS)
 - SRWEC-NYS (Western Landfall Option)
 - Landfall HDD A
 - Landfall HDD B
 - Landfall HDD C
 - Intracoastal Waterway HDD (ICW HDD)
 - Onshore Transmission Cable LIE Service Road Route
 - Onshore Interconnection Cable Route
 - Union Avenue Site / Onshore Converter Station (OnCS-DC)
 - Holbrook Substation
 - Village Boundary
 - Town Boundary

Notes
1. SRWEC route will have one landfall location. Routes are indicative and subject to engineering design changes.
Sources
Base map: NAIP 2019

Date	12/18/2020 Revised: 6/1/2021
Project Number	2028113199
Prepared By	PB
Reviewed By	LJ

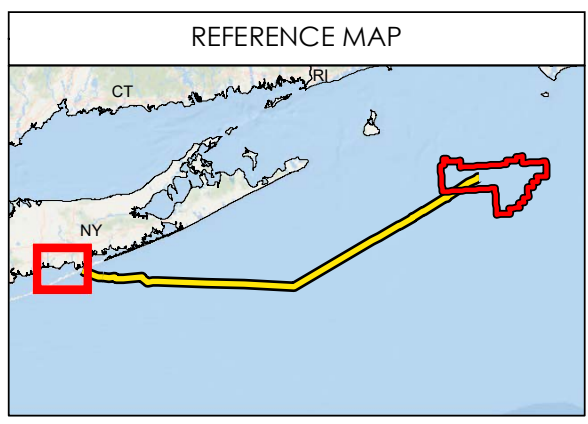
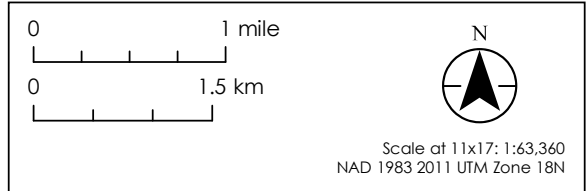

This page intentionally left blank

CONSTRUCTION AND OPERATIONS PLAN

Description of Proposed Activity – Project Design and Construction Activities

3.3.2.1 Onshore Interconnection Cable

The Onshore Interconnection Cable will convey AC power from the OnCS–DC to the existing Holbrook Substation. A cross section of a typical onshore AC transmission cable is provided in Figure 3.3.2-2 below.

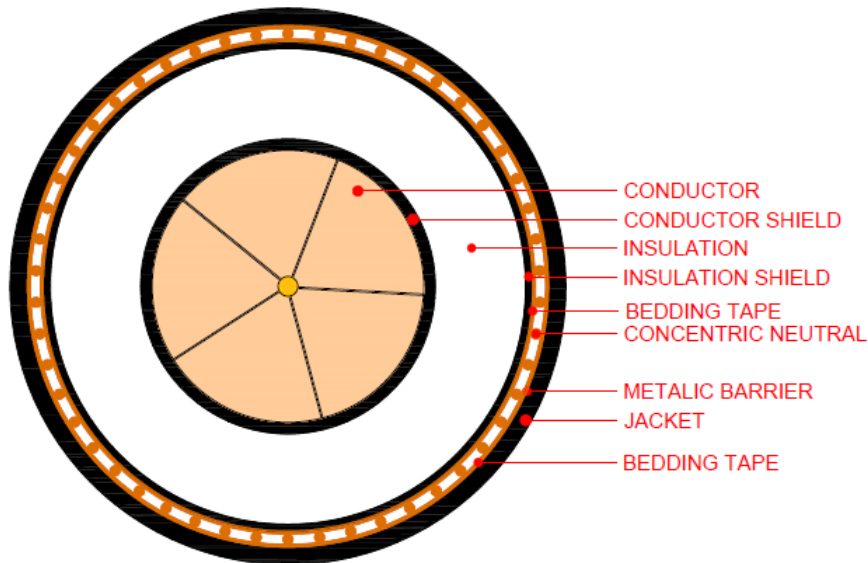

Figure 3.3.2-2 Typical Onshore Single-Phase Cable Cross-Section

The maximum design scenario for the AC Onshore Interconnection Cable is provided in Table 3.3.2-1.

Table 3.3.2-1 Onshore Interconnection Cable Maximum Design Scenario

Onshore Interconnection Cable Feature	Maximum Design Scenario
Number of Onshore Interconnection Cables (138-kV)	12
Number of fiber optic cables	2
Voltage Onshore Interconnection Cables	138 kV
Onshore Interconnection Cable diameter	6 in (152 mm)
Fiber optic cable diameter	1 in (2.5 cm)

3.3.2.2 Onshore Transmission Cable

The Onshore Transmission Cable will convey the energy produced by the SRWF to the OnCS–DC. As stated in Section 3.3.2, the SRWEC will connect to the Onshore Transmission Cable within TJBs and link boxes located within the Landfall Work Area. From this location, the two monopole DC cables will be spliced into two DC Onshore Transmission Cables (each comprising a single-phase cable) and two fiber optic cables. A cross section of a typical onshore DC transmission cable is provided in Figure 3.3.2-3 below.

CONSTRUCTION AND OPERATIONS PLAN

Description of Proposed Activity – Project Design and Construction Activities

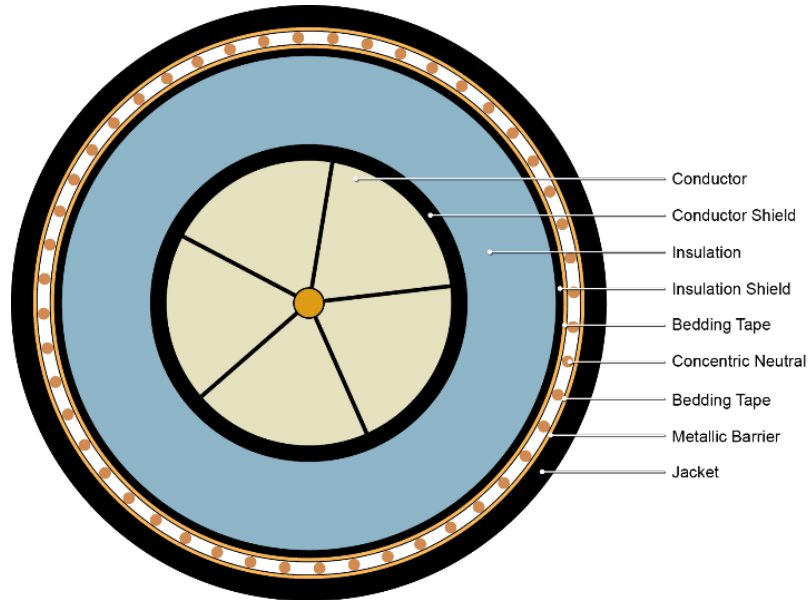

Figure 3.3.2-3 Typical Onshore Single-Phase Cable Cross-Section

The maximum design scenario for the Onshore Transmission Cable is provided in Table 3.3.2-2.

Table 3.3.2-2 Onshore Transmission Cable Maximum Design Scenario

Onshore Transmission Cable Feature	Maximum Design Scenario
Number of Onshore Transmission Cables	2
Number of fiber optic cables	2
Voltage Onshore Transmission Cables	±320 kV
Onshore Transmission Cable diameter	6 in (152 mm)
Fiber optic cable diameter	1 in (2.5 cm)

3.3.2.3 Construction

Construction of the Onshore Transmission Cable and Onshore Interconnection Cable will involve site preparation, trench excavation, duct bank and vault installation, cable installation, cable jointing, and final testing, and restoration with additional steps associated with HDD and other trenchless crossing methods. The typical underground transmission cable construction sequence is provided in Table 3.3.2-3. Temporary laydown yards will be required to support the staging of necessary equipment and materials for the installation of the Onshore Transmission Cable and Onshore Interconnection Cable. Locations selected for the use of temporary laydown yards may require additional assessments prior to use and will be approved by the applicable permitting agencies prior to utilization. These areas will be generally confined to locations containing open land or previously disturbed commercial/industrial sites with existing roadway access, such that no or minimal site improvements are required. Following the completion of the Project, locations used for temporary laydown yards will be restored to pre-existing conditions in accordance with landowner requests and permit requirements.

CONSTRUCTION AND OPERATIONS PLAN

Description of Proposed Activity – Project Design and Construction Activities

Table 3.3.2-3 Typical Underground Transmission Cable Construction Sequence

Activity/Action	Construction Details
Surveys and Protection of Sensitive Areas	Work along the Onshore Transmission Cable route will begin with the survey, staking, and protection of any sensitive areas/services. Access to the work area will then be established and the required safety measures will be implemented.
Site Preparation	Site preparation involves the surveying and staking the proposed Onshore Transmission Cable alignments, implementation of the specified traffic control measures required to perform the work, and soil erosion control methods to prevent runoff into the existing infrastructure and sensitive areas. This stage of the construction will also include identification of any existing underground utilities (DigSafe or test pits) along the proposed alignment.
Clearing and Grading	The work area for the cable route will be cleared of vegetation (where required), and temporary environmental erosion controls such as swales and erosion control socks will be installed in accordance with BMPs. These controls will be maintained until the site is restored and stabilized. Portions of the work area may also require grading.
Duct Bank and Vault Installation	Splice vaults will be spaced approximately every 1,800 to 2,200 ft (549 to 671 m) (1 per circuit) along the route to facilitate the pulling and splicing of cable. These will typically be precast concrete pieces (top and bottom) set within an excavation pit, and then backfilled. The cable ductbank will connect the vaults along the route and consists of conduits installed within an approved concrete or thermal equivalent material. The duct bank will be installed via open trench excavation for the majority of the Project. Once excavated, the conduits will be arranged within the open trench per the design drawings and held in place using conduit spacers to allow the concrete to be poured and set around the ducts. Once the concrete has been poured, it will be allowed to set up to a specific strength before the trench is backfilled. The backfill must meet certain heat transfer requirements and may consist of a fluidized thermal backfill (i.e., weak mix concrete) or a compacted sand or approved gravel mixture. This operation will be repeated until all conduit and concrete has been installed to the specified jointing locations (i.e., manholes, termination structures, etc.). At the completion of the installation, all conduits will be proofed and mandreled to verify continuity of the raceway for cable installation.
Trenchless Installation	<p>The Project will utilize trenchless crossing installation to avoid sensitive environmental resources or other physical obstructions (i.e., railroads) at certain crossing locations. Most of the onshore trenchless installation(s) will utilize the "pipe-jacking" method, which consists of excavating pits on each side of the crossing to facilitate forcing, or jacking, a pipe under a crossing (i.e., railroad). Alternatively, the use of an HDD may be required, which would consist of boring a pilot hole to provide the correct alignment. Once the pilot hole has been completed, the hole will be reamed out to the specific diameter for the ducts within which the cable will be installed to be pulled into the borehole. The installed ducts will facilitate the installation of the power cable and fiber optic cable.</p> <p>To minimize the potential risks associated with an inadvertent drilling fluid return/release, an Inadvertent Return Plan for the inadvertent release of drilling fluids prior to construction and will implement appropriate BMPs.</p>
Cable Installation	Upon completion of the proofing and mandreling of the conduits cable, pulling operations can begin. The cable will be pulled through the duct bank conduits from vault to vault, and is cut leaving a sufficient amount of cable to perform the jointing operations. Once pulling has been completed, and appropriate testing of the cable performed to ensure no damage has occurred during installation (i.e., cable jacket integrity test). The cables will then be sealed to prevent moisture ingress until jointing operations can be performed.
Cable Jointing	Cable jointing refers to the splicing and/or terminating of the cables. Splicing and terminating is performed once all the cables for a specific section have been successfully pulled into the vault, jointing bay, or termination structure. Once splicing and terminating is complete, the cables and accessories will be secured to the associated racking systems with the use of cable clamps. This mitigates lateral movements experienced by the cable during operation.

CONSTRUCTION AND OPERATIONS PLAN

Description of Proposed Activity – Project Design and Construction Activities

Activity/Action	Construction Details
Final Restoration Activities	Once the duct bank and splice vaults have been installed, permanent restoration as required by the governing authority will be completed. For roadway installations, this will include the surface repaving, including installation of the road subbase and base layers followed by the surface layer (i.e., concrete or asphalt). For installations outside of roadways, such as greenbelt areas, final restoration typically involves backfilling to the original grade elevation and hydroseeding to prevent soil erosion.

Installation of the Onshore Transmission Cable will generally require excavation of a trench within a temporary disturbance corridor. The Onshore Transmission Cable will be installed within a concrete or thermal equivalent duct bank buried to a depth consistent with local utility standards. From the OnCS–DC, the Onshore Interconnection Cable will be installed underground within a duct bank to the Holbrook Substation. A typical configuration of an underground onshore transmission circuit is shown in Figure 3.3.2-4. A typical configuration of the installation of an underground onshore transmission circuit within a road ROW is shown in Figure 3.3.2-5. A typical configuration of an underground onshore interconnection circuit is shown in Figure 3.3.2-6.

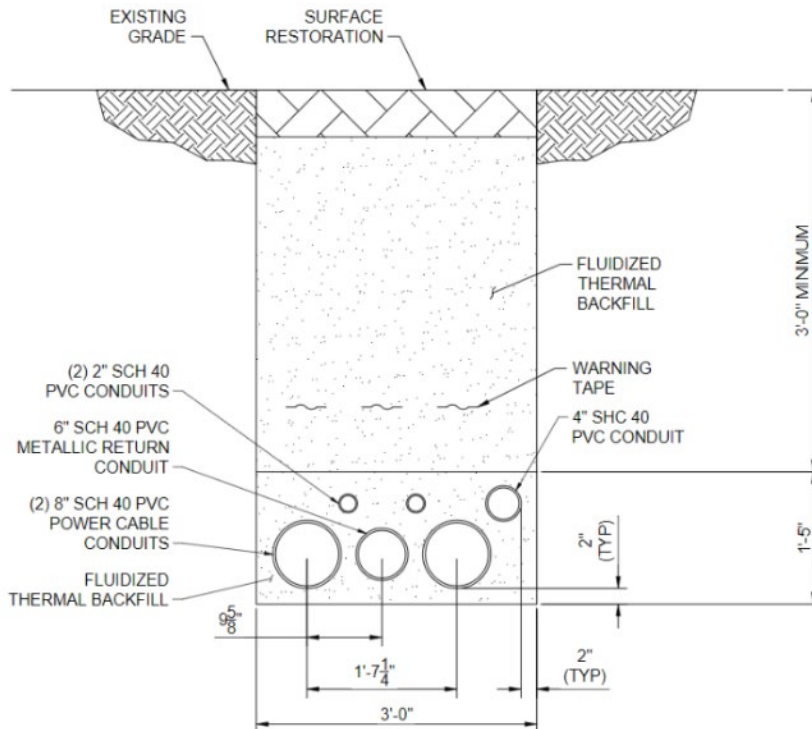

Figure 3.3.2-4 Typical Installation Configuration of Underground Onshore Transmission Circuit

CONSTRUCTION AND OPERATIONS PLAN

Description of Proposed Activity – Project Design and Construction Activities

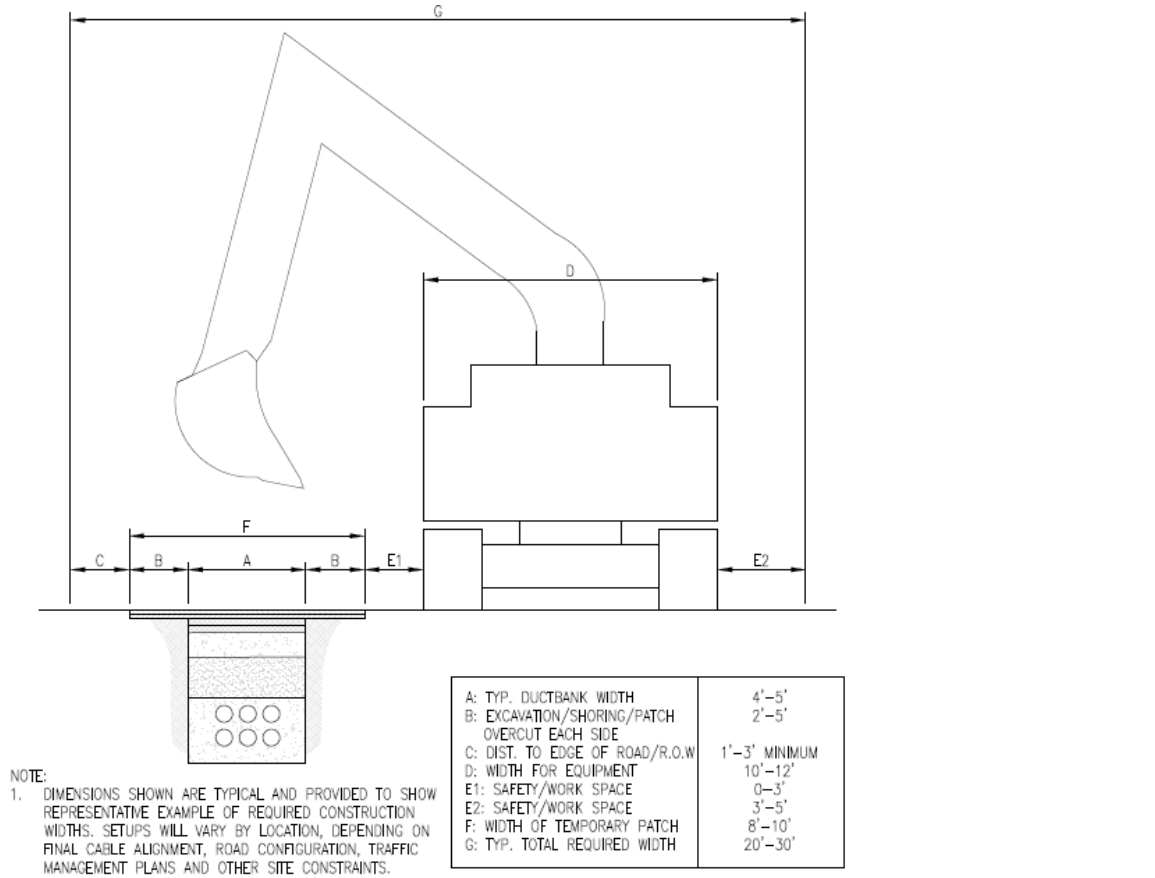

Figure 3.3.2-5 Typical Underground Onshore Transmission Circuit Installation within a Road Right-of-Way

CONSTRUCTION AND OPERATIONS PLAN

Description of Proposed Activity – Project Design and Construction Activities

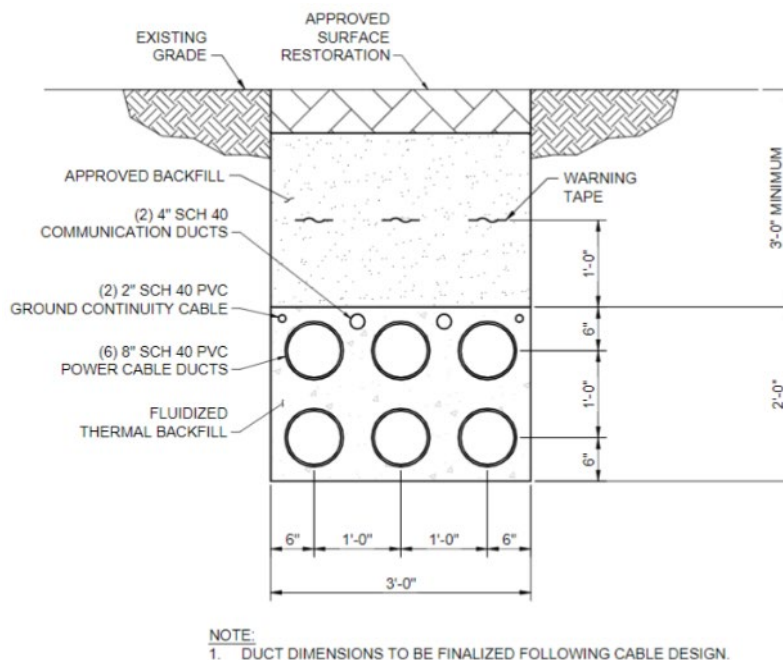

Figure 3.3.2-6 Typical Installation Configuration of Underground Onshore Interconnection Circuit

Due to the length of Onshore Transmission Cable, sections of cable will need to be spliced together with joints for each circuit. Splicing will occur along the entirety of the route approximately every 1,800 to 2,200 ft (549 to 671 m). At each splice location, a splice vault/pit will be required. Once a detailed below grade utility survey is completed, more refined distances between splice vaults/pits can be determined based upon site specifics. In these locations, the temporary disturbance area required will be larger than for the duct bank installation. The splice vaults will be buried to a depth consistent with local utility standards. The entire temporary disturbance corridor will be restored to pre-construction conditions following installation of the Onshore Transmission Cable. The maximum design scenario for the construction of the Onshore Transmission and Onshore Interconnection Cable is provided in Table 3.3.2-4.

Table 3.3.2-4 Onshore Transmission/Interconnection Cable Construction Maximum Design Scenario

Onshore Transmission/Interconnection Cable Feature	Maximum Design Scenario
Temporary Disturbance Width a/	30 ft (9.1 m)
Trench Width	8 ft (2.4 m)
Duct Bank Target Burial Depth (to top of duct bank) b/	3 to 6 ft (0.9 m to 1.8 m)
Splice Vault Construction Disturbance Area	50 ft x 40 ft (15 m x 12 m)
Splice Vault Burial Depth (from surface to bottom of the vault)	Up to 15 ft (4.6 m)
NOTES: a/ Maximum temporary disturbance width excludes disturbance area for crossing locations and splice vaults. b/ Duct bank target burial depth with vary based on site-specific conditions and may be deeper in areas of HDD or trenchless crossings.	

CONSTRUCTION AND OPERATIONS PLAN

Description of Proposed Activity – Project Design and Construction Activities

Installation of the Onshore Transmission Cable will result in the crossing of multiple waterways, major roadways, and rail roads, which will require additional temporary disturbance areas to support the setup of equipment necessary to perform each crossing. The maximum design scenario, identifying the associated crossing method, overall crossing distance, approximate area of temporary and/or permanent impact, along with a description of the workspace locations that will be impacted to facilitate the various major crossings are provided in Table 3.3.2-5.

Table 3.3.2-5 Onshore Transmission Cable and Onshore Interconnection Cable Crossing Locations Maximum Design Scenario

Crossing Name	Crossing Method	Approximate Crossing Length	Approximate Area of Temporary Disturbance	Description of Location and Potential Impacts
Onshore Transmission Cable—LIE Service Road Route				
Intracoastal Waterway (ICW)	Horizontal Directional Drill	2,660 ft (811 m)	80,000 sq ft (7,432 m ²)	Parking lot at Smith Point Marina located off East Concourse/Duneview Drive on the north side of Narrow Bay Recreational area at Smith Point County Park, west of William Floyd Parkway on the south side of Narrow Bay
LIRR Crossing at Church Road	Pipe Jacking	93 ft (28 m)	5,300 sq ft (493 m ²)	Green space to the north of LIRR along paper road Green space to the south of LIRR along paper road
Sunrise Highway (State Route [SR] 27) at Revilo Avenue	Horizontal Directional Drill	877 ft (267 m)	38,700 sq ft (3,596 m ²)	Green space within NYSDOT-owned retention basin to the south of Sunrise Highway east of Revilo Avenue Green space to the north of Sunrise Highway Paved roadway of Revilo Avenue to the north of Sunrise Highway
Carmans River Crossing	Horizontal Directional Drill	1,990 ft (607 m)	75,000 sq ft (6,968 m ²)	Green space to the north of Victory Avenue within Southaven County Park to the west of Carmans River Southern edge of ROW and paved shoulder of Victory Avenue to the east of Carmans River Southern edge of ROW and paved shoulder of Victory Avenue to the west of Carmans River
Manor Road Crossing of LIRR	Pipe Jacking	99 ft (30 m)	5,000 sq ft (465 m ²)	Green space to the north of LIRR on Manor Road Paved portions of Manor Road and green space to the south of LIRR
Onshore Interconnection Cable Route				
LIE (I-495) Trenchless Crossing - LIPA ROW	Pipe Jacking	400 ft (122 m)	5,800 sq ft (539 m ²)	Green space on North Service Road, LIPA overhead transmission ROW Green Space to the south of South Service Road, LIPA overhead transmission ROW

CONSTRUCTION AND OPERATIONS PLAN

Description of Proposed Activity – Project Design and Construction Activities

3.3.3 Sunrise Wind Export Cable

The SRWEC will be spliced together with the Onshore Transmission Cable at the co-located TJBs and link boxes located at the landfall location at Smith Point County Park, in the Town of Brookhaven, New York. The SRWEC will traverse both federal and New York state waters (see Figure 1.1-1). In addition, a segment of the SRWEC (up to 1,575 ft [480 m]) will be located onshore (i.e., above the MHWL) and underground, up to the TJBs.

Sunrise Wind has completed geophysical and geotechnical surveys (G&G) to inform the siting and design of the SRWEC. A detailed overview of the surveys that have occurred along the SRWEC and the results of the investigations are provided in Appendix G1 – *Marine Site Investigation Report (MSIR)*, under confidential cover. Sunrise Wind has identified certain geologic features, including areas of boulders and mobile sediment, and anthropogenic hazards and sub-surface geological hazards along the SRWEC route, which are discussed in more detail in Appendix G1 and will be taken into account during the engineering process..

From August 2019 through November 2019, a geophysical reconnaissance survey for the SRWEC corridor (Sunrise Wind GP1A/1B Export Cable Corridor Recon [2019]) was conducted. The survey covered the SRWEC from the SRWF to the landfall at Smith Point County Park in the Town of Brookhaven, New York. The objectives of the survey were to obtain accurate bathymetry, map the seabed morphology and classify the seabed sediments, construct a shallow seismic stratigraphic and structural model, identify ferromagnetic objects and archeological features, and provide information on potential geo-hazards related to cable installation. Additional geophysical surveys were conducted along the SRWEC from March 2020 through August 2020 as a continuation of the Sunrise Wind GP1A/1B ECC Recon (2019) survey to characterize the seabed and subsurface geologic conditions in detail to support the engineering and design plan for the SRWEC. The results of these surveys are provided in the MSIR.

Geotechnical surveys of the SRWEC were conducted from May 2020 through January 2021. The purpose of the surveys was to acquire geotechnical data along the SRWEC to support the engineering and design plan for the export cables and HDD. The results of the survey are included in the MSIR, with additional geotechnical information obtained to support the HDD design at Smith Point County Park to be provided in the FDR/FIR.

3.3.3.1 TJB and Link Box Design

TJBs are comprised of pits that are dug in the soil and lined with concrete. The purpose of a TJB is to provide a clean, dry environment for the jointing of the SRWEC and Onshore Transmission Cable as well as protecting the joint once the jointing is completed and allowing for inspections if necessary. There will be up to two TJBs (i.e., one for each SRWEC cable). In each TJB, each SRWEC cable will be spliced into one single-phase conductor onshore cable. The sheaths from the SRWEC and the Onshore Transmission Cable will be terminated into the link box via the cable joints. The fiber optic cable from the SRWEC and Onshore Transmission Cable will be joined inside the fiber optic joint box. There will be up to two TJBs, two link boxes, and two fiber optic cable joint boxes.

CONSTRUCTION AND OPERATIONS PLAN

Description of Proposed Activity – Project Design and Construction Activities

A conceptual schematic of the TJBs is provided in Figure 3.3.3-1. Each of the co-located TJBs will be up to 82 ft x 16 ft x 16 ft (25 m x 5 m x 5 m). The Project-specific TJB is in the preliminary design stages and will be finalized with detailed design in the Project EM&CP. Should a fiber optic cable joint box and link box be required, an additional concrete pit approximately 6.6 ft x 6.6 ft x 6.6 ft (2 m x 2 m x 2 m) would be needed for each. The TJBs, link boxes, and fiber optic cable joint boxes will be located entirely within the Landfall Work Area. Access to the fiber optic handhole and link box handhole near the TJBs during the operational phase will be via manhole covers. Access to the splices in a TJB would require excavation from grade to expose the splices.

A precast splice vault may also be used as an alternative to TJBs. The precast splice vault would consist of dimensions similar to the TJB; however, the splices would be housed in a precast enclosure on all sides, with manhole risers and covers for access from grade. Access to the link box would be provided via the splice vault and access to the fiber optic cable joint box would be via manhole cover to a separate chamber outside of the splice vault. The amount of ground disturbance would be similar between the two options.

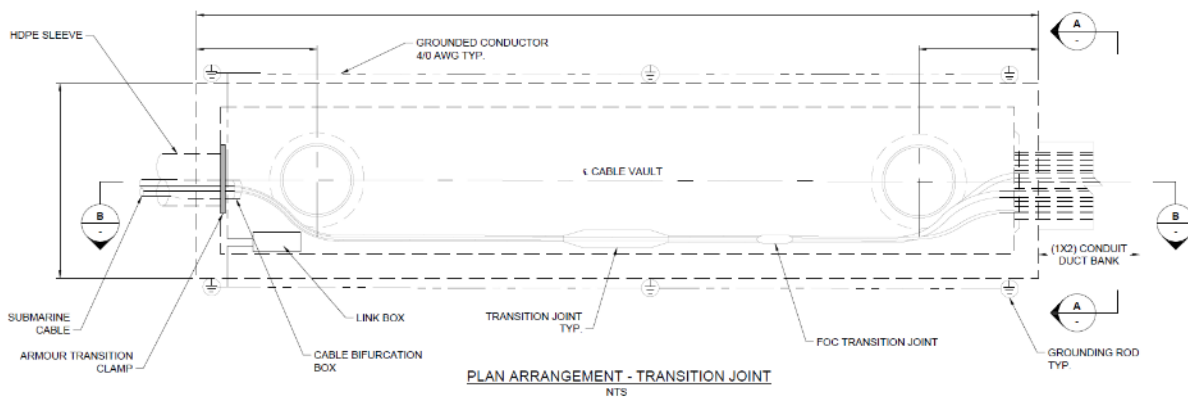

Figure 3.3.3-1 Example TJBs and Link Boxes

The design of the TJB, fiber optic cable joint boxes, and link boxes will take into account site conditions, including geology and potential for flooding. The conduits for the TJB, fiber optic cable joint boxes, and link boxes are sealed to prevent the ingress of water. As sea level rises, the frequency of flooding from high tides and storm surges will also increase. The location of the TJB at Smith Point County Park is located on the landward side of the Limit of Moderate Wave Action line as depicted on the effective FEMA Flood Insurance Rate Maps (see Section 4.4.1 and Figure 6 of Appendix L – *Onshore Ecological Assessment and Field Survey Report*). As such, the Base Flood Elevation for the site is located in an area where the controlling wave heights are less than 1.5 ft (0.5 m). According to the Flood Insurance Study, the “stillwater” elevation at these locations would be 9.3 ft (2.8 m) North American Vertical Datum of 1988 (NAVD88) for the 100-year storm and 11.3 ft (3.4 m) NAVD88 for the 500-year storm (FEMA 2009). Adding the worst case 1.7 ft (0.5 m) of sea level rise provides a future design flood elevation (DFE) of 13.0 ft (3.9 m) NAVD88.

CONSTRUCTION AND OPERATIONS PLAN

Description of Proposed Activity – Project Design and Construction Activities

The following subsections further describe the design and construction of the SRWEC. From a construction perspective, installation techniques will vary by segment of the SRWEC. Therefore, there are separate subsections describing construction of the SRWEC at the landfall location and more generally in the offshore environment.

3.3.3.2 SRWEC Design

The SRWEC will be comprised of one distinct cable bundle and will transfer the electricity from the OCS-DC to the TJBs located within the Landfall Work Area at Smith Point County Park. The SRWEC will be joined with the Onshore Transmission Cable at the TJB.

The SRWEC will consist of one cable bundle comprised of two cables traversing through both federal and NYS waters. Each subsea cable is connected to one pole of the OCS-DC and cables are bundled together during installation. Each cable within the single bundle will consist of one copper or aluminum conductor core surrounded by layers of cross-linked polyethylene insulation and various protective armoring and sheathing to protect the cable from external damage and keep it watertight. A fiber optic cable will be bundled together with the two main conductors. Continuous monitoring of the SRWEC is provided by the fiber optic cable, as discussed below, which assists in cable fault detection, control and monitoring, and communication. A cross-section of a typical DC subsea cable is provided in Figure 3.3.3-2. The survey corridor width varies between approximately 1,312 ft and 2,625 ft (400 and 800 m) depending on water depth.

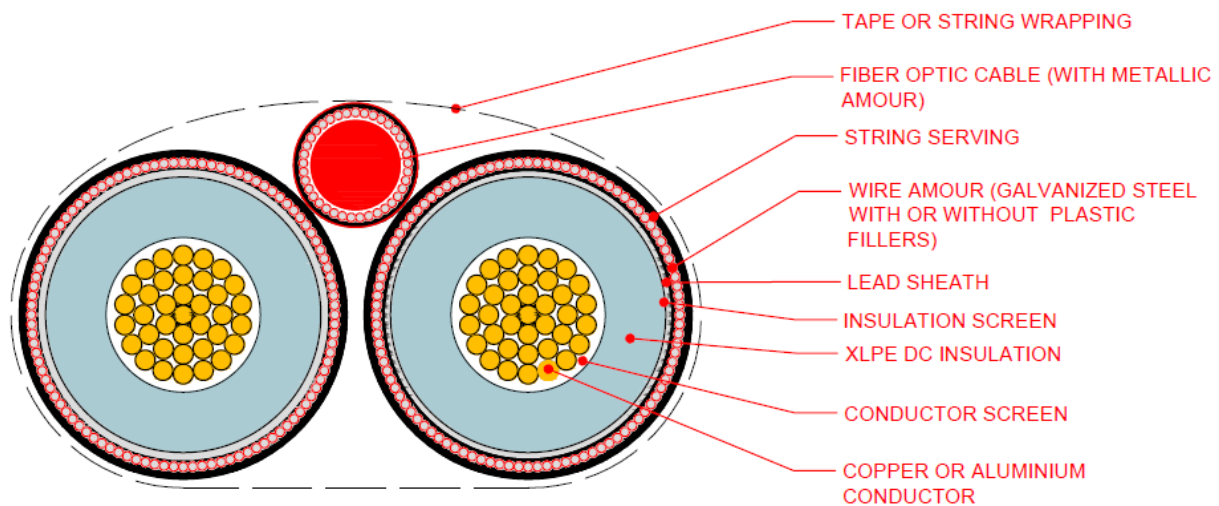

Figure 3.3.3-2 Typical DC Subsea Cable Cross-Section

CONSTRUCTION AND OPERATIONS PLAN

Description of Proposed Activity – Project Design and Construction Activities

The maximum design scenario for the SRWEC is provided in Table 3.3.3-1.

Table 3.3.3-1 SRWEC Maximum Design Scenario

Offshore Export Cable Feature	Maximum Design Scenario
Number of Cables	2 cables bundled together with a fiber optic cable
Voltage per Circuit	±320 DC
Individual Cable Diameter	7.8 in (200 mm)
Target Burial Depth a/	3 to 7 ft (1 to 2 m)
Number of Joints Per Cable	up to 4
Approximate Total Corridor Length	106 mi (170 km)
<i>Federal</i>	99.4 mi (160 km)
<i>New York</i>	6.2 mi (10 km)
Survey Corridor Width b/	1,312 to 2,625 ft (400 to 800 m)
Max Water Depth	
<i>Federal c/</i>	223 ft (68 m)
<i>New York c/</i>	95 ft (29 m)
Requested Project Easement for Operational ROW d/	
<i>Federal</i>	200 ft (61 m)
<i>New York</i>	30 ft (9 m)
<p>NOTES:</p> <p>a/ Burial of the SRWEC will typically target a depth of 3 to 7 ft (1 to 2 m). The target burial depth for the SRWEC will be determined based on an assessment of seabed conditions, seabed mobility, the risk of interaction with external hazards such as fishing gear and vessel anchors, and a site-specific Cable Burial Risk Assessment.</p> <p>b/ Survey corridor width varies based on water depth.</p> <p>c/ Maximum water depth is based on site-specific geophysical surveys, and reflects the mean lower low water (MLLW) along the SRWEC.</p> <p>d/ The Project Easement for Operational ROW is based on default Project Easement for Operational ROW widths for BOEM and NYS. A Project Easement for Operational ROW will also be requested from NPS. Project Easement for Operational ROW does not include O&M activities.</p>	

3.3.3.3 Landfall Construction

Sunrise Wind will land the SRWEC at the landfall location via HDD methodology. The HDD installation would have a minimal impact on coastal resources at Smith Point. Up to three HDDs will be installed to support the landfall of the SWREC, including one for each of the transmission cables of the bundle, as well as one additional third borehole to be used if it is technically or physically infeasible for the fiber optic cable to be included with the transmission cables. . Up to two ducts will be installed in each drilled hole, one for the transmission cable, and one for the fiber optic cable. The HDD methodology will require temporary use of a Landfall Work Area located onshore within which the TJBs will be installed and HDD construction activities will occur, including cable pull in activities (Figure 3.3.3-3). The Landfall Work Area is not inclusive of the area required for HDD cable duct stringing activities nor the area required for a temporary floating pier to support barging equipment and materials to Smith Point County Park required for

CONSTRUCTION AND OPERATIONS PLAN

Description of Proposed Activity – Project Design and Construction Activities

the Landfall HDD and ICW HDD (3.3.10.2). Three approaches are being explored for the HDD path for the SRWEC to reach the Landfall Work Area (Figure 3.3.3-3) due to the presence of an existing telecommunications cable in proximity to the landfall location.

- Landfall HDD A would require no crossing of the existing telecommunications cable with the SRWEC. If Landfall HDD A were utilized, the existing telecommunications cable would be crossed onshore with the Onshore Transmission Cable.
- Landfall HDD B would require crossing of the existing telecommunications cable with the HDD itself, and the SRWEC would cross beneath the existing telecommunications cable via HDD.
- Landfall HDD C would involve crossing the existing cable offshore.

Selection of an approach will be dependent on review of the final G&G survey data and continued coordination with the asset owner, Suffolk County Parks Department, and NPS.

The HDD installation involves drilling a horizontal bore underneath the seafloor surface and the intertidal area using a drilling rig located onshore within the Landfall Work Area. The process uses drilling heads and reaming tools of various sizes controlled from the rig to create a passage that is wide enough to accommodate the cable duct. Drilling fluid, comprised of bentonite, drilling additives, and water is pumped to the drilling head during the drilling process to stabilize the hole preventing collapse, and to return the cuttings to the rig site where the cuttings will be separated from the drilling fluids and the fluid recycled for re-use. Sunrise Wind will use a casing pipe, if the geology and site is suitable, to support drilling operations. The casing pipe will contain and collect drilling fluid within the casing to minimize dispersal into the marine environment. The casing pipe solution will likely require a steel casing and supporting sheetpiles to be installed temporarily at the HDD exit pit locations during HDD installation and provide a closed system for the drilling fluids. Additional details will be provided in the Project EM&CP. A temporary sheetpile anchor wall may be installed onshore in front of the HDD rig to anchor the rig into position and provide stability while conducting drilling activities. Due to the forces exerted during the HDD installation process, particularly while the HDD rig is used to pull the duct through the borehole from offshore to onshore, additional stability provided by the sheetpiles are required for the onshore rig. Additional details will be provided in the Project EM&CP.

In addition to the anchor wall, the workspace may also require the installation of other temporary sheetpiles to aid in anchoring of the rig and/or to provide soil stabilization of the excavated area. The location of the Landfall/ICW Work Area is depicted in Figure 3.3.3-3 and a simplified HDD installation schematic is provided in Figure 3.3.3-4.

V:\1956\active\Task Owner and other Non-BC1956.Jobs\2028113199\03_data\gis_ced\gis\mxd\COP\2028113199_3.3.3-3_LandfallStudyArea.mxd Revised: 2021-05-18 By: gcarpentier

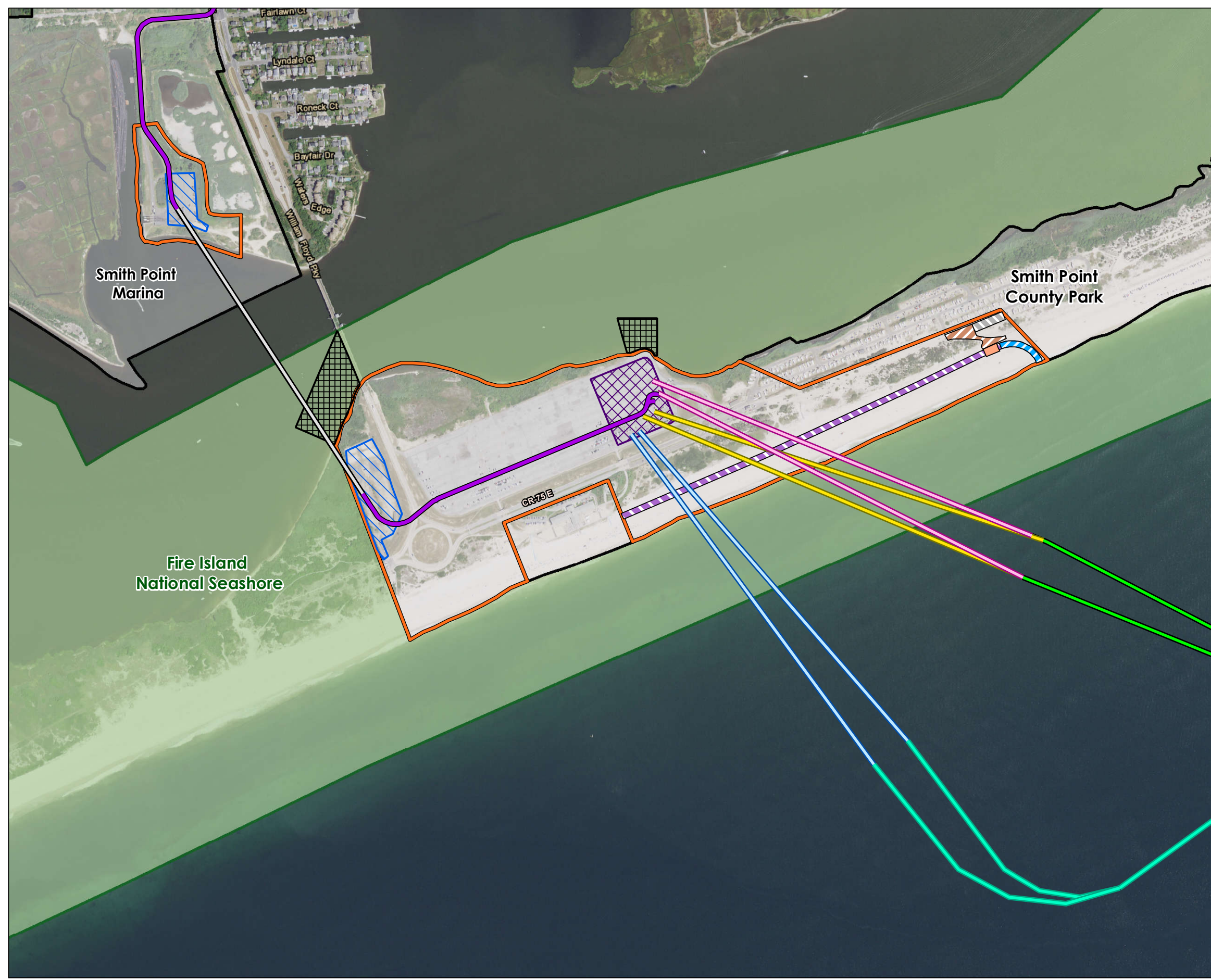

Figure 3.3.3-3
Landfall/ICW Study Area

Sunrise Wind

Powered by
Ørsted & Eversource

- Legend**
- Sunrise Wind Export Cable (SRWEC-NYS)
 - SRWEC-NYS (Western Landfall Option)
 - Landfall HDD A
 - Landfall HDD B
 - Landfall HDD C
 - Intracoastal Waterway HDD (ICW HDD)
 - Onshore Transmission Cable
 - LIE Service Road Route
 - Landfall/ICW Study Area
 - Landfall Work Area
 - Temporary Floating Pier Area
 - ICW Work Area
 - Pipe Welding Area
 - Pipe Sea Access
 - Pipe Storage
 - Pipe Stringing Area
 - Indicative Access to Beach Work Area
 - Smith Point County Park
 - Fire Island National Seashore

Notes
1. SRWEC route will have one landfall location. Routes are indicative and subject to engineering design changes.

Sources
NYSDEC, NPS
Base map: NAIP 2019

Date	12/18/2020 Revised: 6/1/2021
Project Number	2028113199
Prepared By	GC
Reviewed By	LJ

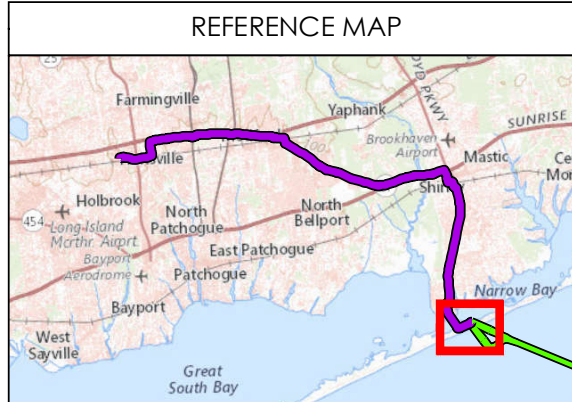
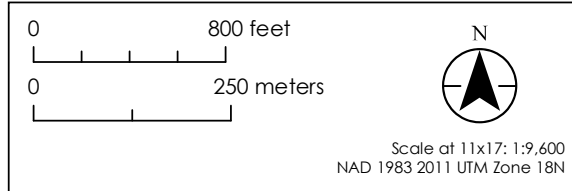

This page intentionally left blank

CONSTRUCTION AND OPERATIONS PLAN

Description of Proposed Activity – Project Design and Construction Activities

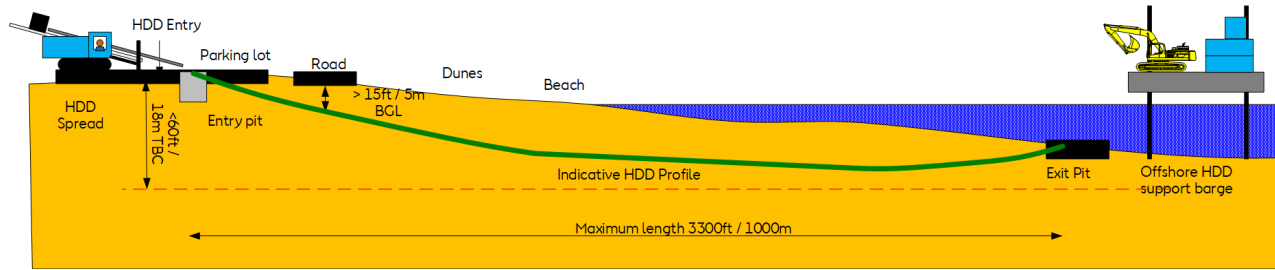

Figure 3.3.3-4 Simplified Landfall HDD Schematic

Once the bore has been sufficiently enlarged and cleansed, the duct is connected to the drill string either on the barge or with the assistance of divers and the marine support spread and pulled into the prepared hole by the onshore HDD rig from offshore towards the drilling rig located at the Landfall Work Area. The duct will be assembled offsite and floated to the site by tugs, or it will be assembled on the beach at Smith Point County Park and maneuvered offshore for installation (see Appendix F – *Conceptual Design Drawings*, provided under confidential cover). If assembled on the beach, this action would require welding and short-term placement (i.e., 2–3 weeks per duct) of assembled HDD conduit sections laid out on approximately 3,500 ft (1,067 m) of beach. HDD conduit stringing is anticipated to occur between October and March.

Up to two ducts will be installed in each drilled hole, one for the transmission cable and one for the fiber optic cable, pending engineering design. Once the duct(s) are installed in the first drilled hole, the drilling rig will be repositioned, and the process will be repeated for drilling and installing the next duct(s). The offshore duct end will be laid down and secured using a suitable form of ballast such as concrete mattress and/or rock bags awaiting the subsequent installation of the export cable. When the export cable installation begins, a pull winch attached to either a piled anchor or a gravity anchor (e.g., a large bulldozer) will then be used to pull the cable through the conduit. Sunrise Wind will drill up to three HDDs to support the landfall of the SRWEC–NYS. Depending on the geology and engineering design, the fiber optic cable will either be installed in one of the boreholes that contains one of the transmission cables or the fiber optic cable will be installed separately in the third HDD borehole. Following installation, the HDD exit pits would be predominantly backfilled.

To support HDD installation, HDD exit pits will be excavated offshore within the surveyed corridor and outside of the Fire Island National Seashore boundary. HDD exit pits (one per HDD) will be excavated where the drill will reach the seafloor surface and to support subsequent burial of the HDD duct beneath the seabed. Upon completion of the excavation of the offshore exit pit(s), it is anticipated that temporary rock bags may be lowered into the excavation from the marine support vessel. The rock bags will prevent the natural backfill of the excavation during the drilling process and therefore prevent a need to re-excavate later. Once the drilling has been completed, the rock bags will be removed to enable the lowering of the duct end and awaiting subsequent cable installation and final backfill of the excavation. The depth and actual length of the HDD will depend on the soil conditions and final cable specifications. A barge or jack-up vessel may be used at this location to assist the drilling process, excavate the exit pit, and handle the duct for pull in.

CONSTRUCTION AND OPERATIONS PLAN

Description of Proposed Activity – Project Design and Construction Activities

To minimize the potential risks associated with an inadvertent drilling fluid return/release, Sunrise Wind will develop an Inadvertent Return Plan prior to construction for the inadvertent release of drilling fluids. The maximum design scenario for the Landfall HDD is provided in Table 3.3.3-2.

Table 3.3.3-2 Landfall HDD Maximum Design Scenario

HDD Feature	Maximum Design Scenario
Number of HDDs a/	3
Number of HDD Cable Ducts b/	6
Diameter of Ducts	3.0 ft (0.9 m)
Maximum Length of Ducts	0.9 mi (1.5 km)
HDD Target Burial Depth c/	5 to 75 ft (1.5 to 25 m)
HDD Exit Pit dimensions (Length x Width x Depth)	164 ft x 49 ft x 16 ft (50 m x 15 m x 5 m)
Onshore HDD Temporary Anchor Wall Dimensions	33 ft (10 m) wide, driven to a depth of 26 ft (8 m)
NOTES: a/ Assumes up to three HDDs at the cable landfall location (one for each transmission cable of the bundle and one spare). b/ Assumes 6 ducts (2 ducts per HDD) c/ The depth of drilling will be defined during the engineering process.	

Once the Landfall HDD is installed and cable pull in has occurred, the SRWEC will be installed via excavation of a trench from the Landfall HDD onshore entry point to the TJB where the jointing of the SREWC and Onshore Transmission Cable will occur. The trenching will be completed via open cut and possibly extending the ducts installed for the Landfall HDD to the TJBs. The trenching between the Landfall HDD onshore entry point and the TJB would occur within the Landfall Work Area. The maximum disturbance areas for construction and operation of the SRWEC Landfall are provided in Table 3.3.3-3.

CONSTRUCTION AND OPERATIONS PLAN

Description of Proposed Activity – Project Design and Construction Activities

Table 3.3.3-3 Maximum Disturbance Areas for SRWEC Landfall

Parameter	Maximum Area of Disturbance
Onshore	
Landfall Work Area a/ b/	6.5 ac (2.6 ha)
TJB Area (per TJB) c/	0.03 ac (0.0125 ha)
Offshore	
Area of Seafloor Disturbance for HDD Exit Pits a/ d/	61.8 ac (25 ha)
<p>NOTES:</p> <p>a/ Post construction, all work areas would be graded and/or backfilled and returned to pre-construction conditions.</p> <p>b/ The Landfall Work Area defines the area within which the indicative workspace and ancillary equipment will be sited. The anticipated area used will be a minimum of 328 ft x 328 ft (100 m x 100 m) within the Landfall Work Area. The work area is inclusive of all Landfall HDD installation activities, including onshore trenching between end of HDD ducts and TJB is included, as well as construction of TJBs and link boxes. Trenching of Onshore Transmission Cable from TJB to ICW Work Area and HDD cable duct stringing activities are not included in this area. Area assumes 328 ft x 328 ft (100 m x 100 m).</p> <p>c/ 82 ft x 16 ft (25 m x 5 m), not including link boxes or fiber optic cable boxes.</p> <p>d/ HDD exit pits will be approximately 164 ft x 49 ft x 16 ft (50 m x 15 m x 5 m) in dimension; a maximum of three exit pits will be required for the Project. Area of Disturbance is inclusive of the HDD exit pit and perimeter bund, anchoring area (approximately 1,640 ft x 1,640 ft [500 m x 500 m]) and separation of the HDD exit pits at the seafloor (HDD exit pits will be approximately 328 ft [100 m] apart).</p>	

3.3.3.4 Offshore Construction

Offshore, the SRWEC will be installed within a survey corridor ranging in width from 1,312 to 2,625 ft (400 to 800 m), depending on water depth. The total width of the disturbance corridor for installation of the SRWEC will be up to 98 ft (30 m), inclusive of any required sand wave leveling and boulder clearance. Dynamic Positioning (DP) vessels will generally be used for cable burial activities. If anchoring (or a pull ahead anchor) is necessary during cable installation, it will occur within the survey corridor (see Section 3.3.9.4 for additional information on vessel anchoring).

Burial of the SRWEC will typically target a depth of 3 to 7 ft (1 to 2 m). The target burial depth for the SRWEC will be determined based on an assessment of seafloor conditions, seafloor mobility, the risk of interaction with external hazards such as fishing gear and vessel anchors, and a site-specific Cable Burial Risk Assessment. The Cable Burial Risk Assessment will be prepared for the FDR to be reviewed by the CVA and submitted to BOEM prior to construction. The *Cable Burial Feasibility Assessment*, which provides an assessment of cable burial based on review of site-specific survey data, is provided with the MSIR as Appendix G4, under confidential cover. Where burial cannot occur, sufficient burial depth cannot be achieved, or protection is required due to cables crossing other existing cables, additional cable protection methods may be used (cable protection is discussed further below). The location of the SRWEC and associated cable protection will be provided to NOAA's Office of Coast Survey after installation is completed so that they may be marked on nautical charts. Burial depths at specific locations will be formalized in the FDR/FIR.

CONSTRUCTION AND OPERATIONS PLAN

Description of Proposed Activity – Project Design and Construction Activities

Installation of the SRWEC consists of a sequence of events, including pre-lay cable surveys, seafloor preparation, offshore cable installation, beginning with cable pull in to the landfall, joint construction, cable installation surveys, cable protection, and connection to the OCS–DC, as summarized in Table 3.3.3-4. The construction schedule for the SRWEC is provided in Section 3.2. In addition to the summary provided in Table 3.3.3-4, the following subsections describe seafloor preparation, cable installation methodologies, and cable protection strategies further.

Table 3.3.3-4 Typical Offshore Export Cable Installation Sequence

Activity/Action	Construction Summary
Pre-lay Cable Surveys	Prior to installation, geophysical surveys will be performed to check for debris and obstructions that may affect cable installation.
Seafloor Preparation	Seafloor preparation will include required sand wave leveling, boulder clearance, and removal of any out of service cables. Boulder clearance trials may be performed prior to wide-scale seafloor preparation activities to evaluate efficacy of boulder clearing techniques.
Pre-Lay Grapnel Runs (PLGR)	PLGR runs will be undertaken to remove any seafloor debris along the export cable route. A specialized vessel will tow a grapnel rig along the centerline of each cable to recover any debris to the deck for appropriate licensed disposal ashore.
Cable Installation	Following cable pull in at the landfall through the Landfall HDD cable pipe, the HDD duct will be filled with thermal grout. From the landfall location towards the SRWF, the offshore cable laying vessel will move along the pre-determined route within the established corridor. Cable lay and burial trials within the 98-ft (30-m)-wide disturbance corridor may be performed prior to main cable installation activities to test equipment. The cable bundle will be laid on the seafloor and then trenched post-lay. Alternatively, a trench may be pre-cut prior to cable installation.
Joint Construction	Installation of the SRWEC will require offshore subsea joints due to the length of the SRWEC. The joints will be located in federal waters within the 98-ft (30-m)-wide disturbance corridor. The subsea joint will be protected by maritized housing approximately four times the cross-sectional diameter of the cable. The joint housing will be protected using similar methods to those described below for cable protection. In case of repair due to damage additional joints may be required during construction.
Cable Installation Surveys	Cable installation surveys will be required, including pre- and post-installation surveys, to determine the cable lay-down position and the cable burial depth. Depending on the instruments selected, type of survey, length of cable, etc., the survey will be completed by vessel mounted equipment.
Cable Protection	Cable protection in the form of rock placement, rock/grout bags and/or mattresses may be installed in areas where the target burial depths have not been achieved depending on factors such as the as-built burial depths, cable burial risk and suitability to perform remedial works. Cable protection will be installed from an anchored or DP support vessel that will place the protection material over the designated area(s).
Connection to OCS–DC	At the OCS–DC, the export cables will be pulled through pre-installed j-tubes and secured.

CONSTRUCTION AND OPERATIONS PLAN

Description of Proposed Activity – Project Design and Construction Activities

MEC/UXO Risk Mitigation

While during Project construction, the likelihood of munitions and explosives of concern / unexploded ordnance (MEC/UXO) encounter is very low, prior to seafloor preparation, cable routing, and micrositing of all assets, the Project will implement a munitions and explosives of concern / unexploded ordnance (MEC/UXO) Risk Assessment with Risk Mitigation Strategy (RARMS) designed to evaluate and reduce risk in accordance with the As Low As Reasonably Practicable (ALARP) risk mitigation principle. The RARMS consists of a phased process beginning with a Desktop Study and Risk Assessment that identifies potential sources of MEC/UXO hazard based on charted MEC/UXO locations and historical activities, assesses the baseline (pre-mitigation) risk that MEC/UXO pose to the Project, and recommends a strategy to mitigate that risk to ALARP. Appendix G2 – *MEC/UXO Risk Assessment with Risk Mitigation Strategy* presents this study and strategies, and is provided under confidential cover.

Avoidance is the preferred approach for MEC/UXO mitigation; however, it is anticipated that there may be instances where confirmed MEC/UXO avoidance is not possible due to layout restrictions, presence of archaeological resources, or other factors that preclude micro siting. In such situations, confirmed MEC/UXO may be removed through in-situ disposal or physical relocation. Selection of a removal method will depend on the location, size, and condition of the confirmed MEC/UXO, and will be made in consultation with a MEC/UXO specialist and in coordination with the appropriate agencies.

In-situ disposal will be done with low noise methods like deflagration of the MEC/UXO or cutting the MEC/UXO up to extract the explosive components. The MEC/UXO might also be relocated through a “Lift and Shift” operation, the relocation will be to another suitable location on the seabed within the APE or previous designated disposal areas for either wet storage or disposal through low noise methods as described for in situ disposal. For all MEC/UXO clearance methods, safety measures such as the use of guard vessels, enforcement of safety zones, and others will be identified in consultation with a UXO/MEC specialist and the appropriate agencies and implemented as appropriate.

During Project construction, the likelihood of MEC/UXO encounter is very low. Sunrise Wind will work with BOEM to identify appropriate response actions, which may include developing an emergency response plan, conducting MEC/UXO-specific safety briefings, retaining an on-call MEC/UXO consultant, or other measures (See Appendix G2 for additional detail).

Boulder Removal

Boulder removal may be required in targeted locations to clear boulders along the SRWEC prior to installation. Boulder removal can be performed using a combination of methods to optimize clearance of boulder debris of varying size and frequency. Removal is based on pre-surveys to identify location, size, and density of boulders. Where required, Sunrise Wind has assumed the route would be cleared of boulders up to 98 ft (30 m) in width along the final SRWEC centerline. Boulder removal would occur prior to installation and would be completed by a support vessel based on pre-construction surveys.

CONSTRUCTION AND OPERATIONS PLAN

Description of Proposed Activity – Project Design and Construction Activities

The following two techniques may be used to complete boulder removal prior to installation of the SRWEC:

Boulder Grab: Boulder grabs are most likely deployed from a DP offshore support vessel and are completed prior to cable installation works. Removal is based on pre-construction surveys to identify both location and size of boulders. This method is typically used to remove large boulders and is most suited to low density boulder areas. A drawing of a typical boulder grab configuration is provided in Figure 3.3.3-5.



Figure 3.3.3-5 Typical Boulder Grab Configuration

The typical boulder grab methodology includes the following steps:

1. A grab is lowered to the seafloor over the target boulder.
 2. Once grabbed, the boulder is either relocated away from the lay corridor or recovered to deck.
- **Boulder Plow:** Boulder removal is completed by a high-bollard pull vessel prior to cable installation works. A towed plow is configured for boulder clearance, generally forming an extended V-configuration, splaying from the rear of the main chassis. A drawing of a typical boulder plow configuration is provided in Figure 3.3.3-6.

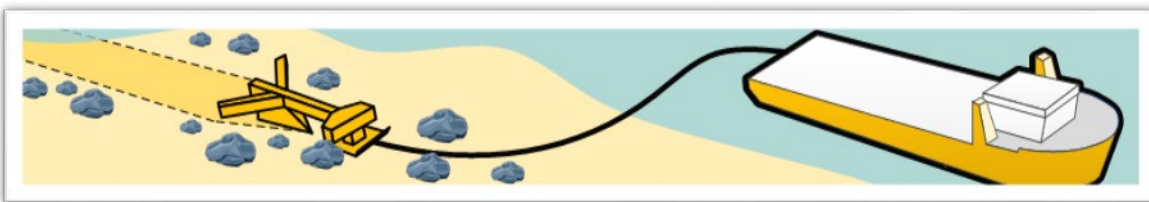

Figure 3.3.3-6 Typical Boulder Plow Configuration

CONSTRUCTION AND OPERATIONS PLAN

Description of Proposed Activity – Project Design and Construction Activities

The typical boulder plow methodology includes the following steps:

1. The vessel is positioned on the cable route and the plow is launched and lowered to seafloor.
2. The vessel moves along the route dragging the plow along the seafloor.
3. The “V” shaped configuration forces boulders to the plow’s extremities, thus establishing a clear corridor for cable installation.
4. Multiple passes of the boulder plow along the cable route may be required to gain the required width.
5. Boulder grab campaign could be required afterwards to remove any remaining boulders.
6. On completion of the operation, a post clearance survey is carried out, using either Multibeam Echo Sounding (MBES) or a Side-Scan Sonar (SSS) to confirm that boulder removal has been achieved.

Sand Wave Leveling

Sand wave leveling (inclusive of leveling of sand accumulation areas) may also be required during seafloor preparation activities prior to installation of the SRWEC. Based on geophysical data, sand waves have not been identified along the SRWEC–OCS, however, some sand accumulation areas have been identified. Sunrise Wind has assumed a maximum of 10 percent of the SRWEC–OCS will require sand wave leveling before the cable can be installed. Sand accumulation areas have been identified along the SRWEC–NYS. Sunrise Wind has assumed a maximum of 40 percent of the SRWEC–NYS will require sand wave leveling before the cable can be installed (see Appendix G1 for additional information). This is a conservative estimate as it assumes that all seafloor features along the route are mobile; the actual number will be refined following the results of additional sediment mobility studies. Where required, Sunrise Wind has assumed the 98-ft (30-m) construction corridor would be cleared of sand waves. Sand wave removal is typically completed for the following reasons:

- Many of the cable installation tools proposed require a relatively flat seafloor surface so that the operational criteria (pitch and roll) of the tools is not exceeded. The seafloor slope angles may be leveled to ensure burial tool maneuverability. The maximum acceptable slope angle will depend on the burial tool selected; and
- Export cables must be buried beneath the stable seafloor elevation to avoid cable exposure during the lifetime of the Project. A portion of the dynamic seafloor layer may be removed if the stable seafloor elevation is out of the burial tool’s reach.

CONSTRUCTION AND OPERATIONS PLAN

Description of Proposed Activity – Project Design and Construction Activities

Available methodologies for sand wave leveling include dredging and controlled flow excavation (CFE), which can be used as stand-alone or in combination. CFE methodology is described below in the offshore cable installation methodology section. The dredging technique is used to recover and relocate material from one location to another by means of suction hopper dredger, as described below.

- **Suction Hopper Dredger:** This system consists of one or more suction downpipes equipped with a seafloor drag head. The drag head is towed over the sand wave by the vessel, while a pump system “sucks” fluidized sand into the vessel's storage hopper. Any sediment removed would be relocated within the local sand wave field along the SRWEC and IAC via continuous overflow from the vessel. Alternatively, the removed sediment can be caught in the hopper storage and the vessel can relocate to a designated storage or disposal area, and either offload material through a hatch in the vessel's hull, or more carefully position material subsea via means of a downpipe.

Pre-Lay Grapnel Run (PLGR)

As described in Table 3.3.3-4, seafloor preparation activities, including pre-lay grapnel run (PLGR), may be required prior to installation of the SRWEC. A PLGR campaign is carried-out to remove debris such as wires, ropes, fishing nets, and out of service cable removal from the seafloor. The goal of this process is to remove any risk of entanglements with submarine cables and installation tools.

Once deployed on the seafloor, the PLGR equipment is towed once along the planned submarine cable route within an accuracy of approximately ± 32 ft (10 m) and a penetration depth of up to 1.6 ft (0.5 m) (subject to soil conditions). Best practice recommends a PLGR campaign to take place no more than two weeks prior to the start of the submarine cable installation campaign.

Offshore Cable Installation Methodology

Selection of cable installation methodologies is dependent on sediment conditions. As sediment conditions range along the SRWEC and within the SRWF, several different cable installation methodologies may be required during installation. Sunrise Wind has completed geophysical surveys of the SRWEC to inform preliminary cable routing and selection of the most appropriate tools for installation of the SRWEC to the target burial depths. The cable bundle will be laid on the seafloor and then trenched post-lay. Alternatively, a trench may be pre-cut prior to cable installation. Based on current understanding of site-specific conditions between landfall at Smith Point, Long Island, and the SRWF, Sunrise Wind is considering the following techniques to support cable installation, as described below.

CONSTRUCTION AND OPERATIONS PLAN

Description of Proposed Activity – Project Design and Construction Activities

- **Mechanical Plowing:** Simultaneous lay and bury mechanical plowing involves pulling a plow along the cable route to simultaneously lay and bury the cable. The plow's share cuts into the soil, opening a temporary trench that is held open by the side walls of the share, while the cable is lowered to the base of the trench via a depressor. This narrow trench infills itself behind the tool, primarily by collapse of the trench walls and/or by natural infill, usually over a relatively brief period. Some plows may use additional jets to fluidize the soil in front of the share. The plow pulling force is either provided by bollard pull (moving vessel) or winches (anchored vessel). This technique may be used for installation of the IAC, but not for the SRWEC, as simultaneous lay and bury methods have been unsuccessful for bundled DC cables.

A drawing of a typical configuration of a simultaneous lay and bury mechanical plow is provided in Figure 3.3.3-7.

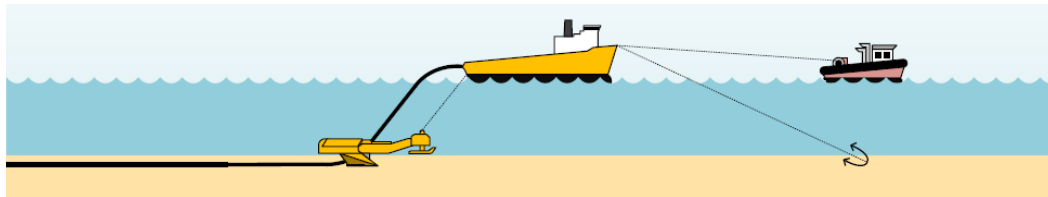

Figure 3.3.3-7 Typical Configuration of a Simultaneous Lay and Bury Mechanical Plow, Aided by Pull Anchor and Tugboat

The typical simultaneous lay and bury mechanical plow installation methodology includes the following steps:

1. At start of lay, the cable is deployed and fed through the plow. The cable is then pulled-in to shore or a structure, as applicable.
 2. As normal lay commences, the plow grades in to burial depth.
 3. Once at depth, normal lay and simultaneous plowing may continue. The plow direction is steered by vessel movements.
 4. Depending on the bollard pull of the vessel, a pull anchor and handler or tugboat may assist the vessel in increasing the bollard pull.
 5. On completion of simultaneous lay and burial operations, a post burial survey is carried out using a MBES or SSS to confirm the mean seafloor and a cable detection system to confirm the target depth of lowering.
- **Jet-Plowing:** This technique involves the use of water jets to fluidize the soil, temporarily opening a channel to enable the cable to be lowered under its own weight or be pushed to the bottom of the trench via a cable depressor. The cable is typically installed after the cable has been laid on the seafloor (post-lay burial). Simultaneous lay and burial with this method is possible for the IAC installation, but not common practice. A drawing of a typical jet plow (post-lay burial) configuration is provided in Figure 3.3.3-8.

CONSTRUCTION AND OPERATIONS PLAN

Description of Proposed Activity – Project Design and Construction Activities

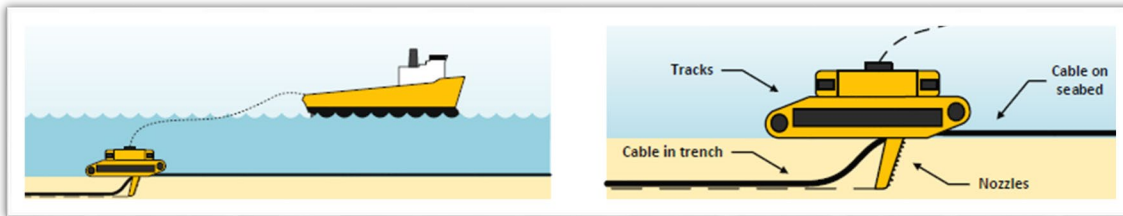

Figure 3.3.3-8 Typical Configuration of a Jet Plow (Post-lay Burial)

The typical jet plow installation methodology includes the following steps:

1. The cable is laid on the seafloor and as-laid/found data is supplied to the burial vessel.
 2. The tool is launched and landed on the seafloor. The tool is typically lowered to the seafloor with a safe distance from any existing subsea cables or pipelines.
 3. Once deployed on the seafloor, the tool will drive over the surface laid cable. It may be necessary to land the tool over the cable.
 4. The tool is then positioned so that the cable is centralized between the tracks (as applicable).
 5. Once in position, the jetting swords are powered and lowered, fluidizing the local seafloor.
 6. The tool moves forward, and the cable is deployed within the trench under gravity or by depressor.
 7. Multiple passes may be required to reach the target burial depth.
 8. On completion of post lay cutting operations, a post burial survey is carried out using a combination of MBES or SSS to confirm the mean seafloor and a cable detection system to confirm the target cable burial depth.
- **Mechanical Cutting:** This technique employs either a cutting wheel or an excavation chain to cut a narrow trench into the seafloor allowing the cable to sink under its own weight or be pushed to the bottom of the trench via a cable depressor. This installation methodology is typically used for post lay burial operations. Although not frequently used as an option, cutting can also be used as a pre-lay solution, the only difference being that the tool is not required to handle the cable while cutting. The cutting tool is unsuitable for areas of cobbles and boulders. It may often incorporate systems for jetting, either simultaneously or independently.

The typical mechanical cutting installation methodology includes the following steps:

1. The cable is laid on the seafloor and as-laid/found data is provided to the burial vessel.
2. The tool is launched from support vessel offset from the cable.
3. Once stable, the tool is positioned with the cable centralized between its tracks.
4. Once in position, mechanical arms lift the cable from the seafloor, clear of the cutting tool.

CONSTRUCTION AND OPERATIONS PLAN

Description of Proposed Activity – Project Design and Construction Activities

5. The cutting tool is lowered to seafloor and commences trench cutting while traversing forward.
6. At the rear of the cutting tool, the cable is lowered into the trench.
7. On completion of post-lay cutting operations, a post-burial survey is carried out using a combination of MBES or SSS for confirming the mean seafloor and a cable detection system to confirm the target cable burial depth.

During cable installation, there may be scenarios where installation to the target burial depth is not achievable using the primary installation methodologies due to mechanical problems with the trencher, adverse weather conditions, and/or unforeseen soil conditions. Therefore, the following alternative installation methodologies would be utilized.

- **CFE:** CFE is a non-contact dredging tool, providing a method of clearing loose sediment below submarine cables, enabling burial. The method utilizes thrust to direct waterflow into sediment, creating liquefaction and subsequent dispersal. The CFE tool draws in seawater from the sides and then jets this water out from a vertical down pipe at a specified pressure and volume. The down pipe is positioned over the cable alignment, enabling the stream of water to fluidize the sands around the cable, which allows the cable to settle into the trench under its own weight.
- **Pre-cut mechanical plowing** involves pre-cutting a trench to the target burial depth in advance of the cable lay operations. Following cable lay, the trench is backfilled via an additional pass using the displaced material to provide sufficient cover on the cable. This method is typically suited for harder soil types, which allows the trench to stay open until cable lay. In softer soils, the trench walls may collapse. The pre-cut plow may also be used for surface boulder clearance, as described previously. This method is unsuitable for IAC installation without significant distances of external protection, as the tool is not able to plow up to installed foundations. A drawing of a typical configuration of a typical pre-cut mechanical plow is provided in Figure 3.3.3-9.

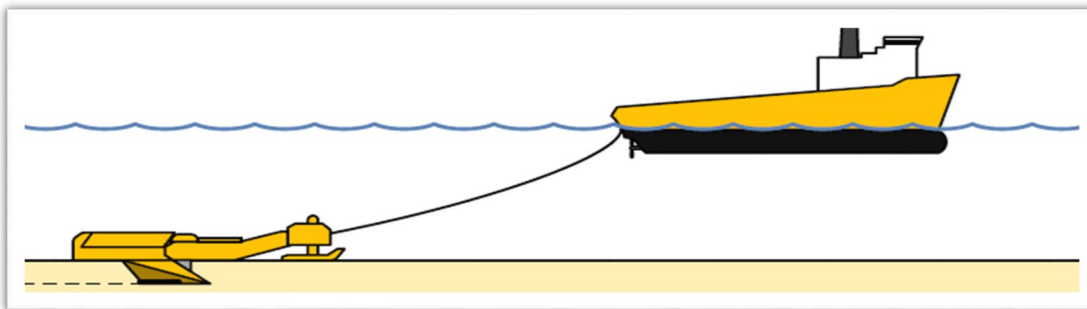

Figure 3.3.3-9 Typical Configuration of a Pre-cut Mechanical Plow

CONSTRUCTION AND OPERATIONS PLAN

Description of Proposed Activity – Project Design and Construction Activities

The typical pre-cut mechanical plow installation methodology includes the following steps:

1. Prior to cable installation, a plow is pulled along the cable lay route, creating a "V" or "box" shaped trench into which the cable can be laid. Note that once deployed on the seafloor, the plow is towed behind the vessel with a lay tolerance of ± 32 ft (10 m) either side of the designed cable route.
 2. Multiple passes may be required to reach the target trench depth.
 3. After the trenching operation, a post trenching survey is carried out using a MBES or SSS to confirm the target trench depth.
 4. For long interim periods, pre-sweeping via a jetting or CFE pass may be required to remove debris/natural backfilling from the trench, prior to cable lay.
- **Pre-Cut Dredging:** This technique is an alternative to pre-cut plowing. A drag head offers another option to pre-form a trench into which the cable can be laid. The drag head is a steel structure that is connected to the dredge vessel via a suction pipe. This technique can utilize one of two methods for managing spoil. Material removed from the trench can be either side-cast as berms on either side of the tool path for subsequent backfill, or material can be recovered to the vessel for subsequent relocation and storage at a pre-designated site. Additional information regarding the use of suction hopper dredging systems is provided above.

The typical pre-cut dredging installation methodology includes the following steps:

1. The drag head and suction pipe are deployed to the seafloor by a crane/gantry and hydraulic winches.
2. The drag head incorporates teeth and water jet nozzles to form the trench shape.
3. Dredged material is either placed within the vessel, and then disposed of on-site, or at an appropriate dredge disposal site. Alternatively, the spoil can be placed beside the trench and used after cable lay for backfilling.
4. Multiple passes may be required to reach the target trench depth.
5. After the trenching operation, a post trenching survey is carried out using a MBES or SSS to confirm the target trench depth.
6. For long interim periods, pre-sweeping via a jetting or CFE pass may be required to remove debris/natural backfilling from the trench, prior to cable lay

Based on the identified range of installation methods and requirements, Sunrise Wind has established a design envelope for installation of the SRWEC that reflects the maximum seafloor disturbance associated with construction (see Table 3.3.3-5). Temporary seafloor disturbance during installation includes the construction disturbance corridor where seafloor preparation would occur prior to cable installation, as well as the installation of the cable. Vessel anchoring occurring within the surveyed corridor during cable installation would also result in temporary seafloor disturbance. Permanent seafloor disturbance includes areas where additional cable protection may be required post-installation.

CONSTRUCTION AND OPERATIONS PLAN

Description of Proposed Activity – Project Design and Construction Activities

Table 3.3.3-5 Maximum Construction Disturbance Areas for SRWEC

Parameter	Maximum Area of Disturbance a/
SRWEC–OCS (Corridor is 99.4 mi [160 km])	
Construction Disturbance Corridor b/	1,185 ac (480 ha)
Boulder Clearance c/	59.3 ac (24 ha)
Sand wave Leveling d/	118.5 ac (48 ha)
Secondary Cable Protection Per Cable e/	23.7 ac (9.6 ha)
Cable Crossing Protection Per Export Cable of Existing Cables f/	14.8 ac (6.0 ha)
SRWEC–NYS (Corridor is 6.2 mi [10 km])	
Construction Disturbance Corridor b/	74 ac (30 ha)
Boulder Clearance b/	22.2 ac (9 ha)
Sand wave Leveling d/	29.6 ac (12 ha)
Secondary Cable Protection e/	1.5 ac (0.6 ha)
Cable Crossing Protection of Existing Cables f/	7.4 ac (2.99 ha)
<p>NOTES:</p> <p>a/ Disturbances area includes installation of one distinct DC cable bundle.</p> <p>b/ SRWEC corridor length x 98 ft (30 m) wide disturbance corridor. Boulder clearance, sand wave leveling, and cable protection will not extend beyond this corridor.</p> <p>c/ Assumes up to 5% of the SRWEC–OCS and up to 30% of SRWEC–NYS may be cleared by using a boulder plow or grab within the 98 ft (30 m) wide corridor.</p> <p>d/ Assumes 10% of the SRWEC–OCS may be cleared of sand waves within a 98 ft (30 m) width corridor (SRWEC–OCS corridor length x 0.1 x 98 ft (30 m)). Assumes up to 40% of SRWEC–NYS may be cleared of sand waves within a 98 ft (30 m) width corridor (SRWEC–NYS corridor length x 0.4 x 98 ft (30 m)).</p> <p>e/ Assumes up to 5% of the SRWEC–OCS would require secondary cable protection, which includes cable protection needed for jointing. Secondary protection will be up to 39 ft (12 m) wide (SRWEC–OCS corridor length x 0.05 x 39 ft (12 m)). Includes areas where additional cable protection may be required post-installation. Assumes up to 5% of the SRWEC–NYS would require secondary cable protection. Secondary protection will be up to 39 ft (12 m) wide (SRWEC–NYS corridor length x 0.05 x 39 ft (12 m)). Includes areas where additional cable protection may be required post-installation.</p> <p>f/ Assumes seven known crossings and three unknowns of the SRWEC in federal waters and up to three known crossing and two unknowns of the SRWEC in NY state waters, requiring additional cable protection and a maximum 1.48 acres (0.6 ha) of seafloor disturbance per cable crossing.</p>	

Upon receipt of the final G&G data, the Project will complete final cable route engineering. The purpose of the final cable routing process is to avoid, where practicable, features along the route that have the potential to impact cable installation. In addition to cable routing, the Project will complete a Cable Burial Risk Assessment, which will support the definition of burial depths for the cable. Furthermore, the installation contractor will perform a burial assessment study in which the site conditions will be described in detail, identifying features such as boulder distribution and dimensions, sand wave height (where applicable), soil strength and classification, seafloor obstructions, and MEC/UXO. Following this detailed information on the installation, final technique(s) will be selected, and burial requirements will be included in the FDR/FIR, to be reviewed by the CVA and submitted to BOEM prior to construction.

CONSTRUCTION AND OPERATIONS PLAN

Description of Proposed Activity – Project Design and Construction Activities

The *Cable Burial Feasibility Assessment*, based on review of site-specific survey data, is provided with the MSIR as Appendix G4.

Cable Protection

Secondary cable protection may be applied where burial cannot occur, sufficient burial depth cannot be achieved due to seafloor conditions, or to avoid risk of interaction with external hazards. The need for secondary cable protection in specific locations will be based on factors such as the as-built burial depths, cable burial risk, and suitability to perform remedial works. Sunrise Wind assumes 5 percent of the route for each cable comprising the SRWEC will require secondary cable protection. The area of impact for secondary cable protection is accounted for in Table 3.3.3-5. It is assumed that secondary cable protection will measure up to 39 ft (12 m) wide.

One or more of the following cable protection solutions may be used for secondary cable protection; schematics of these measures are provided in Appendix F. Cable protection solutions implemented will be of the type that minimizes the potential for gear snags, as feasible.

- **Rock placement:** Rock placement involves dumping or placing rock overtop of a cable to cover and protect it from physical damage. Rocks are normally placed on the seafloor via a fall pipe vessel.
- **Mattressing:** Standard mattresses are composed of concrete blocks linked together by ropes to form a flexible, articulated mat, which can be placed on the seafloor over a cable. Alternatively, Frond Mattresses incorporate aerated polyethylene fronds, which essentially mimic natural seaweed. The purpose of this arrangement is to trap sediment and mitigate scour erosion around the vicinity of the mattress. A standard mattress size is 9.8 ft x 19.6 ft x 0.9 ft (3 m x 6 m x 0.3 m).
- **Rock filter bags:** Rock filter bags consist of a mesh fabric, in which rocks can be deployed subsea. Rock filter bags are suitable for low density coverage and allow more precise placement of material and limit rock migration relative to dumped rock.
- **Grout bags:** Grout bags are suitable for low density coverage.

As noted previously, the location of the SRWEC and associated cable protection will be provided to NOAA's Office of Coast Survey after installation is completed so that they may be marked on nautical charts.

Cable Crossings

The Project's network of submarine cable (inclusive of the SRWEC and IAC) will cross existing submarine assets. There are 7 known telecommunications cables that will be crossed by the SRWEC, two of which may also be crossed by the IAC (Table 3.3.3-6 and Figure 3.3.3-10).

CONSTRUCTION AND OPERATIONS PLAN

Description of Proposed Activity – Project Design and Construction Activities

Table 3.3.3-6 Existing Cable Potential Crossing Locations by the SRWEC and IAC a/

Name of Existing Cable	Facility Owner	Status	Location	Project Component Crossing	Crossing X Latitude b/	Crossing Y Longitude b/
CB-1 (Bermuda Challenger)	Verizon	In service	Federal	SRWEC	40.95969	-71.2098
				IAC	40.9731	-71.2166
				IAC	40.9930	-71.2261
TAT 6	AT&T	Out of service	Federal	SRWEC	40.9340	-71.2668
				IAC	40.9572	-71.2632
				IAC	40.9740	-71.2566
				IAC	40.9910	-71.2501
TAT 12 Seg E1	AT&T	In service	Federal	SRWEC	40.8921	-71.3684
TAT 5	AT&T	Out of service	Federal	SRWEC	40.8728	-71.4158
TAT 10 Seg B	AT&T	Out of service	Federal	SRWEC	40.8494	-71.4740
FLAG Atlantic North	Reliance Globalcom	In service	Federal	SRWEC	40.8082	-71.5763
TAT 12-13 Interlink	AT&T	In service	Federal	SRWEC	40.6973	-72.6056
Apollo North	Apollo	In service	NY State	SRWEC c/	40.7357	-72.8579
				SRWEC d/	40.7271	-72.8438

NOTES:

a/ The existing utilities are indicatively based on a combination of survey data and information provided by utility owners, NOAA, and the North American Submarine Cable Association, and potential crossing locations are indicative. Other utilities may be present.

b/ The Spatial Reference for the Longitude and Latitude coordinates are: NAD83 (2011) – EPSG 6318.

c/ Potential crossing location for Landfall HDD B. Crossing would occur under land with the Landfall HDD.

d/ Potential crossing location for Landfall HDD C.

Cable protection at these crossings will be applied for both in-service assets as well as out-of-service assets that cannot be safely removed and pose a risk to the SRWEC or IAC.

Where appropriate, inactive cable systems will be cut and cleared from the burial route for a short distance on each side. Any cut and cleared cables will typically have the exposed ends weighted with clump weights or short-section chain so that the cable cannot be snagged by other seafloor users, such as fishermen.

CONSTRUCTION AND OPERATIONS PLAN

Description of Proposed Activity – Project Design and Construction Activities

Rock berm or concrete mattress separation layers will be installed prior to cable installation, while the rock berm or concrete mattress cover layers will be installed after cable installation. Any rock berm separation and cover layers will be installed using suitably approved rock material. The rock berm separation and cover layers are defined by minimum geometry and vertical and horizontal tolerances. The amount of cable protection will be as required for suitable coverage and technical agreements with respective asset owners. It is assumed up to 1.48 acres (0.6 ha) of cable protection will be required per crossing. The cable protection required for cable crossings is in addition to the secondary cable protection requirements previously described above.

Sunrise Wind has engaged with each of the identified telecommunication owners during G&G surveys and to discuss crossing and proximity agreements. Four potential WTG positions within the uniform east-west/north-south grid (1.15 by 1.15-mi [1 by 1-nm; 1.85 by 1.85-km] spacing), have been removed due to proximity to existing cables. Final crossing designs will be completed in coordination with each of the asset owners and formalized in crossing and proximity agreements, in line with International Cable Protection Committee recommendations. Crossing and proximity agreements will be provided in the FDR/FIR, to be reviewed by the CVA and submitted to BOEM prior to construction.

V:\1956\active_Task Owner and other Non-BC1956_Jobs\2028113199\03_data\gis_cad\gis\mxd\COP\2028113199_3.3.3-10_Cables\Pipeline.mxd Revised: 2021-05-07 By: gcarpentier

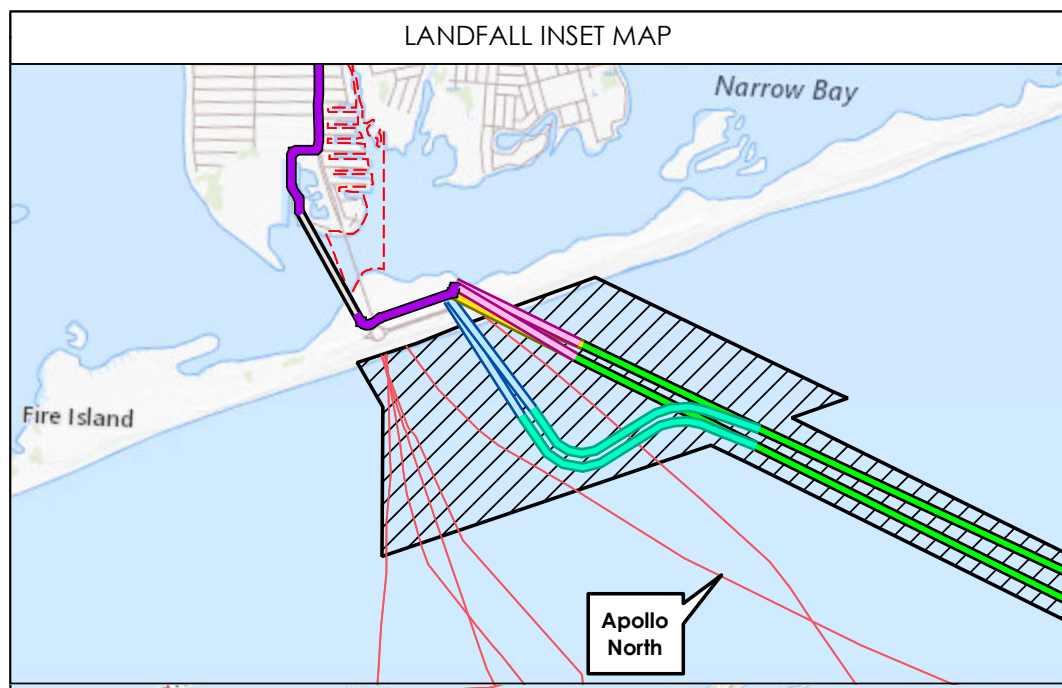
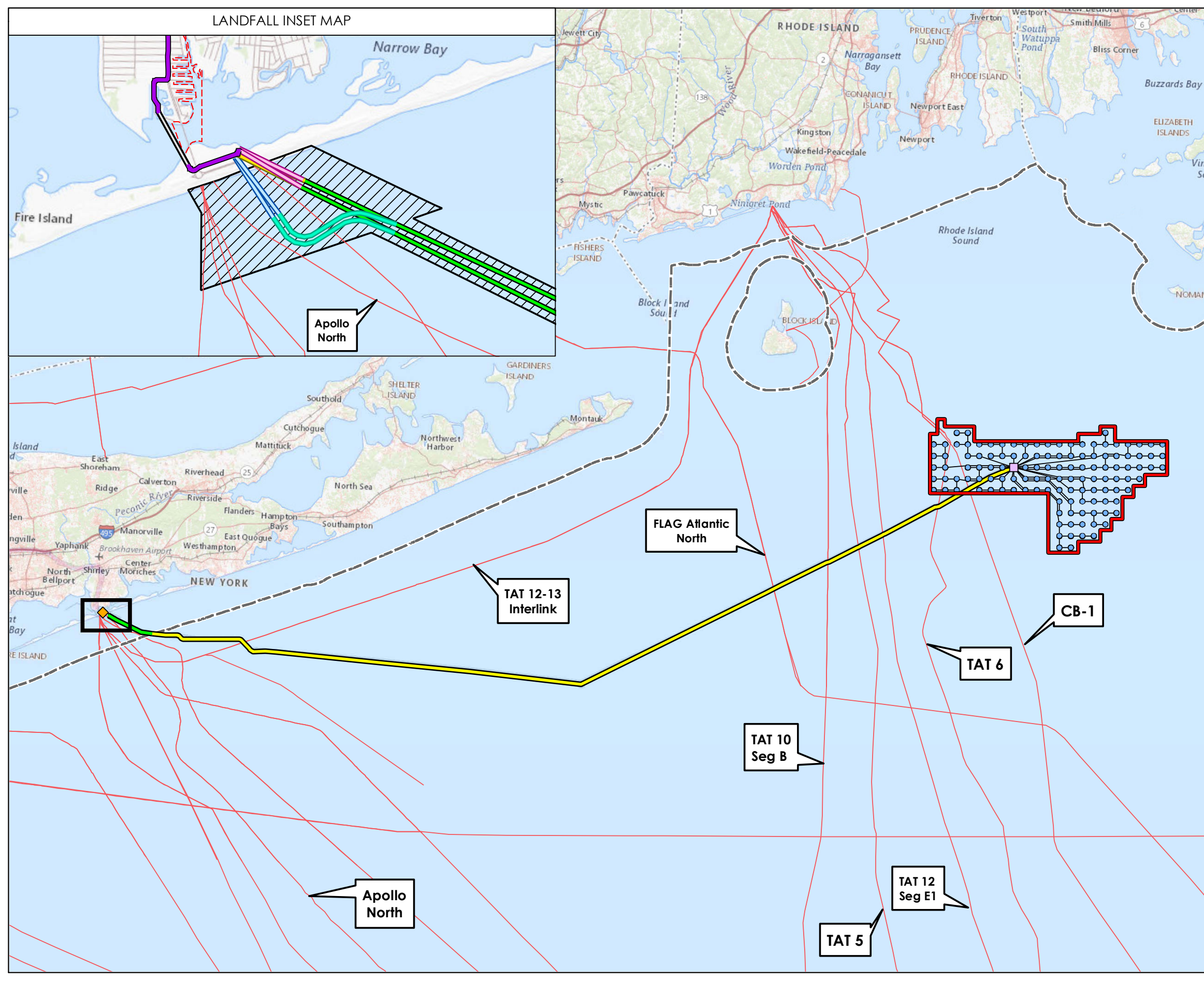

Figure 3.3-10
Existing Cables Crossed
by the SRWEC

Sunrise Wind | Powered by **Ørsted & Eversource**

Legend

- Sunrise Wind Farm (SRWF)
- Indicative Turbine Layout (WTG)
- Offshore Converter Station (OCS-DC)
- Inter-Array Cables (IAC)
- Sunrise Wind Export Cable (SRWEC-OCS)
- Sunrise Wind Export Cable (SRWEC-NYS)
- SRWEC-NYS (Western Landfall Option)
- Landfall HDD A
- Landfall HDD B
- Landfall HDD C
- Intracoastal Waterway HDD (ICW HDD)
- Onshore Transmission Cable LIE Service Road Route
- SRWEC Corridor
- Submarine Cable
- Submarine Cable Area
- 3-nm State Waters Boundary

Note
 Routes are indicative and subject to engineering design changes.

Sources
 1. BOEM, NOAA Office of Ocean Survey
 2. Base map: USGS The National Map

Date	12/18/2020 Revised: 6/1/2021
Project Number	2028113199
Prepared By	GC
Reviewed By	LJ

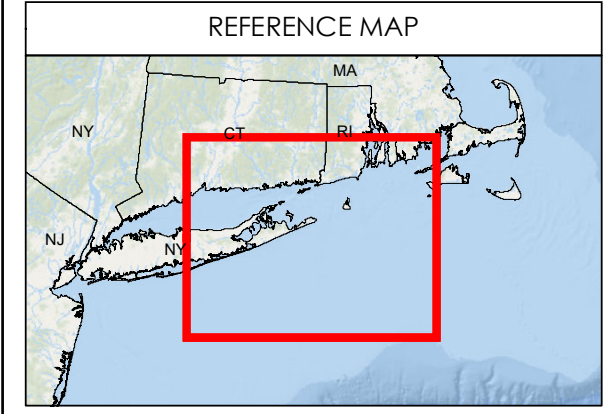
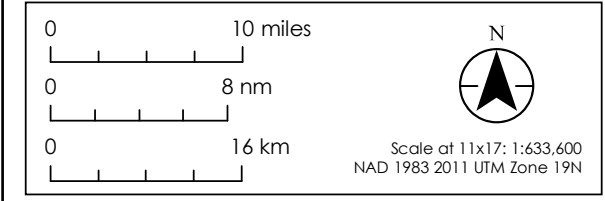

This page intentionally left blank

CONSTRUCTION AND OPERATIONS PLAN

Description of Proposed Activity – Project Design and Construction Activities

3.3.4 Layout Design

Designing and optimizing the layout of WTGs and OCS–DC is a complex, iterative process taking into account a large number of inputs and constraints including, but not necessarily limited to: site conditions (e.g., wind speed and direction, water depth, seafloor conditions, environmental constraints, existing telecommunications cables, and seafloor obstructions); design considerations (e.g., WTG type, installation set-up, foundation design, and electrical design); and stakeholder considerations (e.g., safe navigation and commercial and recreational fishing).

For this COP and associated environmental assessments, Sunrise Wind has committed to an indicative layout scenario with WTGs and the OCS–DC sited in a uniform east-west/ north-south grid with 1.15 by 1.15-mi (1 by 1-nm; 1.85 by 1.85-km) spacing that aligns with other proposed adjacent offshore wind projects in the RI-MA WEA and MA WEA (see Figure 3.3.4-1). In accordance with 30 CFR § 585.634(c)(6), micro-siting of some foundations may occur within a 500-ft (152-m) radius around locations identified in the indicative layout scenario in accordance with USCG Massachusetts and Rhode Island Port Access Routes (MARIPARs) study. Consistent with USCG MARIPARs study recommendations, Sunrise Wind will maintain diagonal lanes between 0.7 and 0.9 mi (0.6 and 0.8 nm; 1.1 and 1.5 km) wide when micro-siting foundations.

The design history for this layout and the alternative layouts considered are described in Section 2.0. The layout as described below is considered in this COP and the associated environmental assessments. A final layout for the Project will be provided as part of the FDR/FIR, to be reviewed by the CVA and submitted to BOEM prior to construction.

Sunrise Wind has completed extensive G&G surveys to inform siting and design of the Project. A detailed overview of the surveys that have occurred in the SRWF and the results of the investigations are provided in Appendix G1. Sunrise Wind has identified certain geologic features, including areas of boulders and mobile sediment, and anthropogenic hazards in the SRWF, which are discussed in more detail in Appendix G1 and will be taken into account during the engineering process..

There have been five previously completed geophysical surveys in the Lease Area that have informed the siting and design of the Project: Bay State Wind Geophys 1A Site (2016); Bay State Wind Geophys 1B Site (2017); Bay State Wind Geophys 1B/APE Site (2018); Sunrise Wind Geophys 1B/APE Site (2019); and Sunrise Wind Geophys 1B (2020). The objective of these surveys was to acquire accurate bathymetry information, classify seabed sediments, map seabed morphology, identify geohazards and anthropogenic features, gather information on ferromagnetic objects, and create a shallow seismic stratigraphic and structural model of the SRWF. These surveys accommodate BOEM's guidelines (BOEM 2020) and results of the surveys are provided in the MSIR.

CONSTRUCTION AND OPERATIONS PLAN

Description of Proposed Activity – Project Design and Construction Activities

Additionally, there have been five previous phases of geotechnical surveys within the SRWF that have informed siting and design of the Project: Bay State Wind Geotech 1A Site (2016); Bay State Wind Geotech 1B Site (2018); Bay State Wind Geotech 2 Site (2019); Sunrise Wind Geotech 1B Site (2019); and Sunrise Wind Geotech IAC Survey (2020). Data from the geotechnical surveys is included in the MSIR. Sunrise Wind is conducting a geotechnical survey at each of the proposed WTG positions (Sunrise Wind Geotech 2 Site), which began in April 2021. The results of the Sunrise Wind Geotech 2 Site survey will be included with the FDR/FIR, in accordance with the Departure Request, which was approved by BOEM on April 26, 2021.

Soil parameters from the results of the Geotech 1B investigation were benchmarked against proprietary data from similar types of offshore wind farm sites. The density and soil characteristics of the majority of soil deposits encountered across the site appear to be conducive to foundation design both from a strength and stiffness perspective. The ground conditions are very comparable to what Ørsted has experienced in several areas of the North Sea where driven monopiles have been successfully installed across numerous offshore wind farm sites in the past. Based on Ørsted's extensive offshore wind experience from more than 1,500 foundations and current knowledge of the ground conditions from the completed geotechnical investigations in the SRWF, Sunrise Wind believes that it is possible to design and install the size and type of foundations included in the PDE to desired target penetration depth.

The indicative SRWF layout is shown in Figure 3.3.4-1. As previously described the layout includes:

- Up to 122 WTGs;
- Up to 123 foundations (for WTGs and an OCS-DC);
- Up to 186 mi (300 km) of IAC;
- One Offshore Converter Station (OCS-DC); and
- One SRWEC, comprised of one distinct cable bundle, located within an up to 106-mi (170-km)-long corridor.

V:\1956\active_Task Owner and other Non-BC\1956_Jobs\2028113199\03_data\gis_cad\gis\mxd\COP\2028113199_3.3.4-1_IndSRFWL layout.mxd Revised: 2021-05-07 By: gcarpenier

Figure 3.3.4-1
Indicative SRWF Layout Design

Sunrise Wind

Powered by
Ørsted & Eversource

Legend

- Sunrise Wind Farm (SRWF)
- Indicative Turbine Layout (WTG)
- Indicative Offshore Converter Station (OCS-DC)
- Indicative Inter-Array Cable (IAC)

Sources

Base map: ESRI World Ocean Base Map

Date	09/01/2020 Revised: 12/18/2020
Project Number	2028113199
Prepared By	GC
Reviewed By	LJ

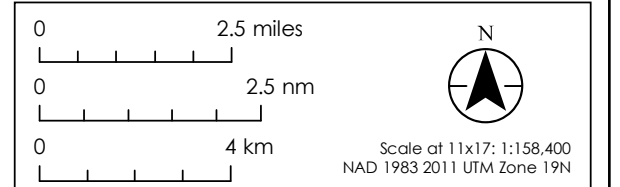

REFERENCE MAP

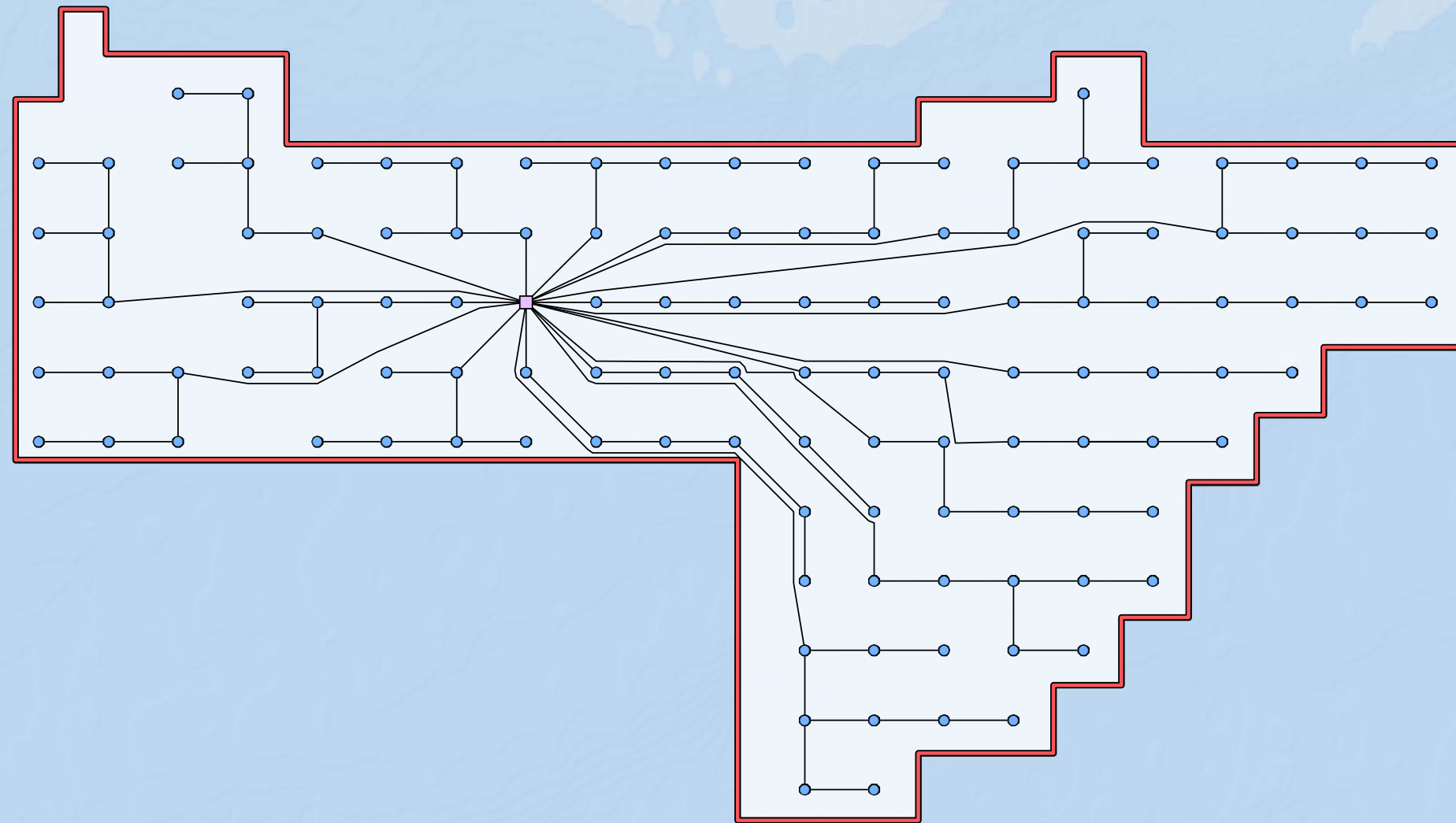
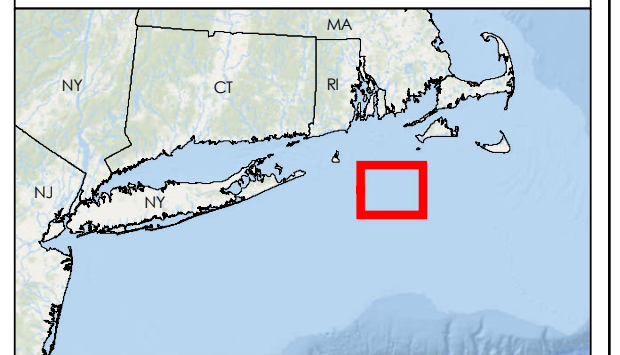

This page intentionally left blank

CONSTRUCTION AND OPERATIONS PLAN

Description of Proposed Activity – Project Design and Construction Activities

3.3.5 Wind Turbine Generator and Offshore Converter Station Foundations

Sunrise Wind requires flexibility in foundation design so that anticipated advancements in the available technology may be accommodated within the Project's final design. For the purpose of this COP, monopile foundations are being considered to support WTGs, and a piled jacket foundation is being considered to support the OCS–DC.

3.3.5.1 Foundation Design

The dimensions for the WTG and OCS–DC foundation types are summarized in Table 3.3.5-1 and conceptual examples are depicted in Figure 3.3.5-1 and Figure 3.3.5-2, as well as in Appendix F. WTG support structures (i.e., towers and foundations) will be designed according to international (e.g., International Electrotechnical Commission [IEC], DNV GL) and American Petroleum Institute (API) standards, including a robustness level assessment based on 500-year return period wind and wave conditions, and an external platform level above the 1,000-year wave crest. The OCS–DC foundations will be designed to a robustness level consistent with the 1,000-year return period wind and wave conditions in accordance with API standards. The foundations will be custom-built to the SRWF site conditions. The reliability of the structures will be based on thousands of load-case calculations, including modeled extreme operational and environmental conditions. These will be performed by both Sunrise Wind, with in-house developed software, and by external engineering companies. The *Foundation Feasibility Assessment* (Appendix G3) has been prepared based on the results of the Project-specific G&G data and is submitted under confidential cover. Finally, the results will be compared, reviewed, and certified by the CVA, and submitted to BOEM, prior to construction.

A monopile foundation typically consists of a single steel tubular section, with several sections of rolled steel plate welded together. For a WTG monopile foundation, a Transition Piece (TP) may be fitted over the top of the monopile and secured via a bolted connection. Secondary structures on each WTG monopile foundation will include a boat landing or alternative means of safe access (e.g., Get Up Safe – a motion compensated hoist system allowing vessel to foundation personnel transfers without a boat landing), ladders, a crane, and other ancillary components. The TP may either be installed separately following the monopile installation or the monopile and TP may be fabricated and installed as an integrated single component. If the monopile and TP are fabricated and installed as an integrated component, the secondary structures will be installed on the TP subsequently and in separate smaller operations. The TP portion will be painted yellow and marked according to USCG requirements. A monopile foundation will only be used for the WTGs. Scour protection will have a radial extension of approximately five times the monopile radius and a height of approximately 6.5 ft (2 m) from original seabed level around selected monopile foundations. Additional cable protection system (CPS) stabilization may be used where the IAC are pulled into the foundation, which would require additional rock cover on top of the scour protection. This additional rock cover would have a height of approximately 6.5 ft (2 m), for a total of up to 13.1 ft (4 m) height from the original seabed level, inclusive of the scour protection and CPS stabilization.

CONSTRUCTION AND OPERATIONS PLAN

Description of Proposed Activity – Project Design and Construction Activities

An up to eight-legged piled jacket foundation will be used for the OCS–DC. A piled jacket foundation is formed of a steel lattice construction (comprising tubular steel members and welded joints) secured to the seafloor by means of hollow steel pin piles attached to the jacket. Unlike monopiles, there is no separate TP; the TP and ancillary components are fabricated as an integrated part of the jacket. Rock may be used to provide a level seafloor around the base of the structure. Scour protection, if required, will cover the entire jacket footprint, extending an additional 33 to 66 ft (10 to 20 m) beyond the base of the structure and reaching a height of approximately 6.5 ft (2 m) from original seabed level. Additional CPS stabilization may be used where the IAC and SRWEC are pulled into the foundation, which would require additional rock cover on top of the scour protection. This additional rock cover would have a height of approximately 6.5 ft (2 m), for a total of up to 13.1 ft (4 m) height from the original seabed level, inclusive of the scour protection and CPS stabilization.

Offshore platform piled jacket substructures such as those that will be used for the OCS–DC are typically designed with mudmats to ensure on-bottom stability of the jacket during installation. The permanent anchoring of the jacket is provided by the piles once installation is complete. Mudmats are typically made up of horizontal plates with vertical stiffeners. Mudmats are designed to distribute the load from the piled jacket into the seafloor, from initial set down of the foundation by the installation vessel, through pile installation and grouting, until the piled jacket is sufficiently supported by piles. The design takes into account environmental loads and the static weight of the piled jacket, as well as bearing capacity of the upper soil layers.

CONSTRUCTION AND OPERATIONS PLAN

Description of Proposed Activity – Project Design and Construction Activities

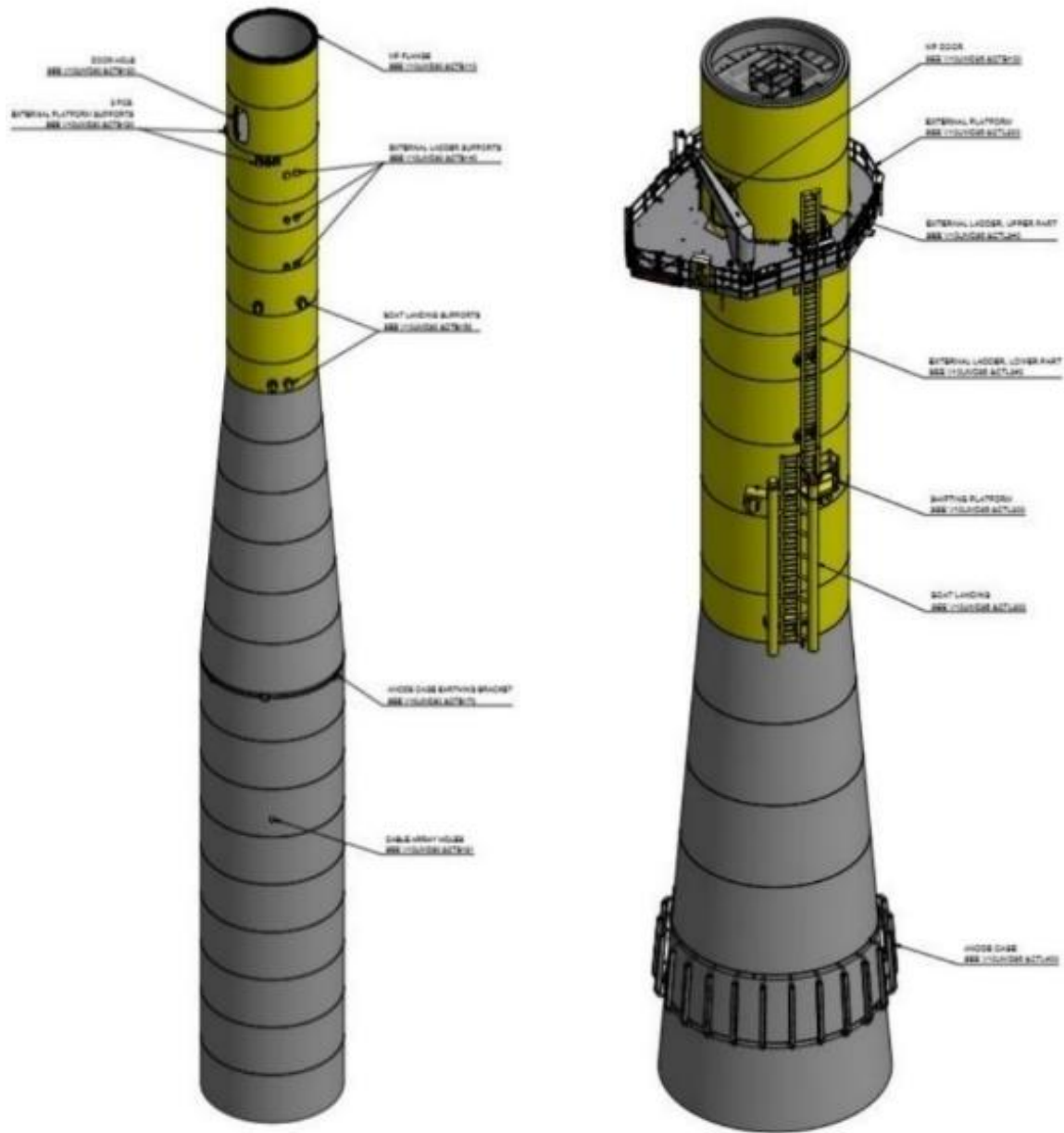

Figure 3.3.5-1 Conceptual Monopile Foundation with Secondary Structure after Installation

CONSTRUCTION AND OPERATIONS PLAN

Description of Proposed Activity – Project Design and Construction Activities

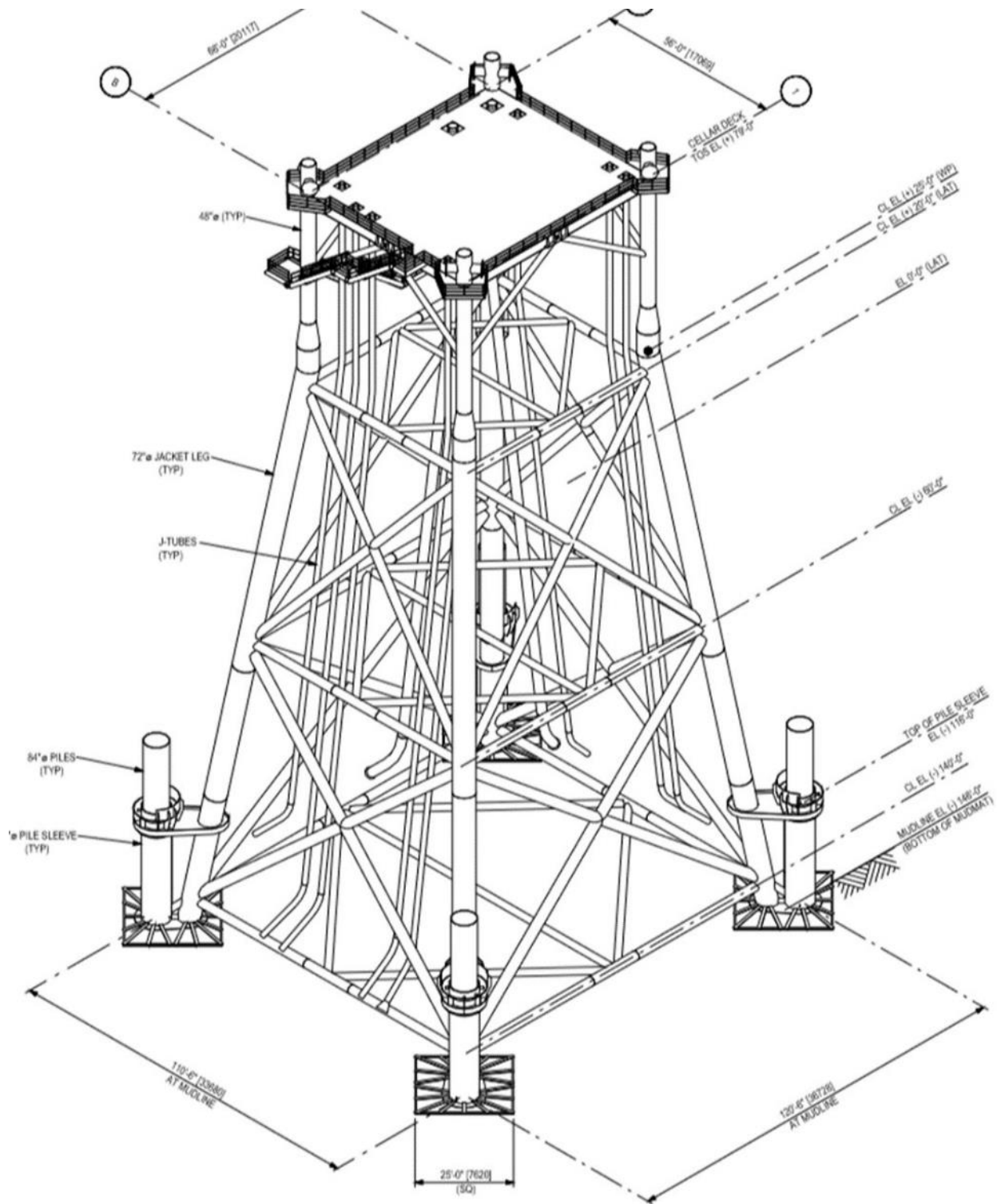

Figure 3.3.5-2 Conceptual Piled Jacket Foundation

CONSTRUCTION AND OPERATIONS PLAN

Description of Proposed Activity – Project Design and Construction Activities

Table 3.3.5-1 Summary of WTG and Offshore Converter Station Foundation Types

Foundation Characteristics	Maximum Parameters (WTGs)	Maximum Parameters (OCS DC)
Monopile		
Diameter of Monopile	39 ft (12 m)	-
Embedment Depth (below seafloor)	164 ft (50 m)	-
Height of Platform Above LAT	67 ft (20.4 m)	-
Weight of Monopile	3,755 metric tons (mT)	-
Maximum Impact Hammer Energy	4,000 kJ	-
Piled Jacket		
Number of Legs	-	8
Total Piles per Structure a/	-	16
Leg Diameter	-	15 ft (4.6 m)
Pin (skirt) Pile Diameter	-	13 ft (4 m)
Embedment Depth (below seafloor)	-	295 ft (90 m)
Height of Platform Above MHHW b/	-	88 ft (26.8 m)
Dimensions of Piled Jacket at MSL b/	-	220 ft x 220 ft (67 m x 67 m)
Dimensions of Piled Jacket at Seafloor Level	-	262 ft x 262 ft (80 m x 80 m)
Mud-mat Area	-	75 ft x 75 ft (23 m x 23 m)
Piled Jacket Structure Weight	-	7,500 mT
Weight of total number of Piles c/	-	7,200 mT
Maximum Impact Hammer Energy	-	4,000 kJ
NOTES: a/ Up to two piles per leg for the OCS-DC b/ MHHW = Mean Higher High Water; MSL = Mean Sea Level c/ assumes 450 mT/pile		

The final foundation design specifications will be determined by the final engineering design process, informed by factors including soil conditions, wave and tidal conditions, Project economics, and procurement approach. Detailed information on the foundations will be included in the FDR/FIR, to be reviewed by the CVA and submitted to BOEM prior to construction.

To promote safety while the foundations are awaiting installation of the TPs (if used) and WTGs, each foundation will be marked and lit in accordance with USCG requirements. In addition, without the TPs or ancillary structures with the equivalent features, there will be no means for unauthorized access to the foundation.

CONSTRUCTION AND OPERATIONS PLAN

Description of Proposed Activity – Project Design and Construction Activities

3.3.5.2 Construction

Maximum seafloor disturbance associated with foundation construction is summarized in Table 3.3.5-2.

Table 3.3.5-2 Maximum Seafloor Disturbance for Foundations

Parameter	Maximum Area of Seafloor Disturbance
WTG Foundations—Monopile	
Seafloor Preparation Area per Foundation a/	37.6 ac (152,053 m ²)
Seafloor Footprint per Foundation	0.73 ac (2,967 m ²)
Scour Protection and CPS Stabilization per Foundation b/	0.70 ac (2,854 m ²)
Total Maximum Area of Seafloor Disturbance c/	4,587 ac (1,855 ha)
Offshore Converter Station Foundations—Piled Jacket	
Seafloor Preparation Area a/	37.6 ac (152,053 m ²)
Seafloor Footprint	2.66 ac (10,780 m ²)
Scour Protection and CPS Stabilization d/	2.66 ac (10,780 m ²)
Total Maximum Area of Seafloor Disturbance	37.6 ac (152,053 m ²)
<p>NOTES:</p> <p>a/ Seafloor Preparation Area will occur within a 722 ft (220 m) radius centered on the foundations to ensure safe foundation installation as well as safe vessel jack-up. Dynamic positioning heavy lift vessels or jack-up vessels with up to four spudcans will be used for foundation installation; jack-up will occur within the Seafloor Preparation Area. Additionally, the seafloor preparation area for the OCS–DC includes up to 0.99 ac (4,000 m²) of additional rock to provide a level seafloor around the base of the structure. Seafloor preparation area is inclusive of impacts due to turbine/OCS–DC installation.</p> <p>b/ Scour protection will have a radial extension of approximately 5 times the radius of the monopile. This value also includes CPS stabilization where the IAC are pulled into the foundation (two IAC per WTG foundation). The additional CPS rock cover around the IAC would extend beyond the scour protection by approximately the radius of the monopile and would be approximately 39 ft (12 m) wide per IAC.</p> <p>c/ Total maximum area assumes 122 WTG foundations.</p> <p>d/ Scour protection will extend up to 66 ft (20 m) beyond the base of the structure. This value also includes CPS stabilization where the cables are pulled into the foundation (12 IAC and SRWEC). The additional CPS rock cover over the IAC and SRWEC would extend beyond the scour protection by an additional 16 ft (5 m) and be approximately 39 ft (12 m) wide per cable.</p>	

A number of operations will be completed prior to the foundation installation process, including:

- **Geophysical Surveys:** to identify seafloor debris and potential MEC/UXO;
- **Geotechnical Surveys:** to identify the geological, archaeological, and cultural resource conditions;
- **MEC/UXO Clearance Surveys:** to identify and confirm MEC/UXO targets for removal/disposal, as described in Section 3.3.3.4; and

CONSTRUCTION AND OPERATIONS PLAN

Description of Proposed Activity – Project Design and Construction Activities

- **Seafloor Debris Clearance:** removal of seafloor debris, boulder clearance, etc., where necessary to ensure the seafloor is suitable for safe foundation installation, as described in Section 3.3.2. Sunrise Wind assumes boulder clearance will occur within a 722-ft (220-m) radius centered on the foundations to ensure safe foundation installation as well as safe vessel jack-up.

The Project will implement measures identified in Appendix G2, as described in Section 3.3.3.4, to evaluate and reduce MEC/UXO risk in accordance with the ALARP risk mitigation principle.

Foundations will be installed following completion of these operations, as summarized in Table 3.3.5-3 (monopile foundations) and Table 3.3.5-4 (piled jacket foundations).

Monopile foundations or pin piles for the piled jacket foundation will be driven to target embedment depths using impact pile driving and/or vibratory pile driving. The maximum impact hammer energies and target embedment depths for each foundation type are presented in Table 3.3.5-3. Installation of a single monopile foundation is estimated to normally require 1 to 4 hours (6 to 12 hours maximum) of pile driving; up to three monopile foundations will be installed in a 24-hour period. Installation of a single piled jacket foundation for the OCS–DC is estimated to require approximately 64 hours maximum of pile driving. It is anticipated that separate installation vessels will complete installation of the WTG monopile foundations and the OCS–DC piled jacket foundation. Piling for the monopile foundations and piled jacket foundation thus may occur simultaneously.

The anticipated foundation installation campaign for WTGs and the OCS–DC is presented in Section 3.2.

Table 3.3.5-3 Typical Monopile Installation Sequence

Activity/Action	Installation Details
Pre-Installation Surveys	Prior to installation, geophysical surveys will be performed to check for debris and obstructions that may affect installation.
Seafloor Preparation	Seafloor preparation will include required boulder clearance and removal of any obstructions within the Seafloor Preparation Area at each foundation location.
Scour Protection	Scour protection installation will occur prior to installation and will involve a rock dumping vessel placing scour at each foundation location.
Foundation Delivery	Monopiles may be transported directly to the Lease Area for installation or to the construction staging port. Monopiles (and TPs if used) are transported to site by an installation vessel, heavy transport vessel and/or a feeder barge.
Foundation Setup	At the foundation location, the main installation vessel upends the monopile in a vertical position in the pile gripper mounted on the side of the vessel. The hydraulic hammer is lifted on top of the pile to commence pile driving.
Pile Driving	Piles are driven until the target embedment depth is met, then the pile hammer is removed and the monopile is released from the pile gripper.
TP Installation (if used) or Secondary Structures Installation	Once the monopile is installed to the target depth, the TP or separate secondary structures will be lifted over the pile by the installation vessel. If used, the TP will be bolted to the monopile.
Completion	Once installation of the monopile and TP is complete, the vessel moves to the next installation location.

CONSTRUCTION AND OPERATIONS PLAN

Description of Proposed Activity – Project Design and Construction Activities

Table 3.3.5-4 Typical Piled Jacket Foundation Installation Sequence

Activity/Action	Installation Details
Pre-Installation Surveys	Prior to installation, geophysical surveys will be performed to check for debris and obstructions that may affect installation.
Seafloor Preparation	Seafloor preparation will include required boulder clearance and removal of any obstructions within the Seafloor Preparation Area at each foundation location.
Scour Protection	Scour protection installation will occur prior to installation and will involve a rock dumping vessel placing scour at each foundation location.
Foundation Delivery	Pin piles and the associated jacket foundations may be transported directly to the Lease Area for construction or to the construction staging port. They are delivered to site by an installation vessel, heavy transport vessel, and/or a feeder barge.
Foundation Setup	If pin piles are installed first, a piling template is lowered to the seafloor and the pin piles are upended and lifted into place in the piling template. The pile hammer is then placed on top of the pin piles for driving. If the jacket is installed first, the jacket is lifted vertically and lowered onto the seafloor and the pin piles lifted into place through the jacket feet for driving.
Pin Pile Driving	Each pin pile is driven in turn until the target embedment depth is met for each pin, then the pile hammer is removed, and the piling template is recovered.
Drilling (optional)	If pile driving for the entire piling installation is not possible due to the presence of rock or hard soil in some lower part of the substrate, the drive and drill method will be used. When the pin pile meets refusal, the pile will be drilled out below the pile tip (couple of meters). Then the piling will be re-established again and piled to its final position. If refusal appears again, however, the drilling/driving will continue until the pin pile has reached its final position.
Piled Jacket Installation	If pin piles are installed first, then after driving (and drilling if necessary) the jacket structure is lifted into place by the installation vessel and the jacket leg stab-ins will be inserted into the pre-installed piles.
Grouting	The joint between the pin piles and the jacket may be cemented using grout, an inert cement mix. Grout is pumped from the installation vessel or another support vessel into the joint while being monitored to minimize loss to the environment.
Completion	Once installation of the jacket foundation is complete, the vessel moves to next location.

Final engineering design may indicate that scour protection is necessary for the foundations, although every individual foundation may not require scour protection. Scour protection is designed to prevent foundation structures from being undermined by hydrodynamic and sedimentary processes, resulting in seafloor erosion and subsequent scour hole formation. The shape of the foundation structure is an important parameter influencing the potential depth of scour hole formation.

It is anticipated that scour protection will be installed prior to installation of the foundations. Several types of scour protection may be considered, including rock placement, mattress protection, sandbags, and stone bags. However, rock placement, in which large quantities of crushed rock are placed around the base of the foundation structure, is the most frequently used solution. The rock placement scour protection solution may comprise a rock armor layer resting on a rock filter layer. The rock filter layer can either be installed before the foundation is installed ('pre-installed') or afterwards ('post-installed'). Rock filter layers may only be used on limited, selected foundations, to prevent erosion of the seabed close to or around the foundation. Furthermore, the filter layer will stabilize a potential armor layer should a two-layer scour protection solution be preferred for a specific foundation position.

CONSTRUCTION AND OPERATIONS PLAN

Description of Proposed Activity – Project Design and Construction Activities

Alternatively, by using heavier rock material with a wider gradation, it is possible to avoid using a filter layer and pre- or post-install a single layer of scour protection.

The amount of scour protection required will vary for the different foundation types being considered and based on the local site conditions. The final choice and design of a scour protection solution for the Project will be made after detailed design of the foundation structure, taking into account a range of aspects including geotechnical data, metocean data, water depth, foundation type, maintenance strategy, agency coordination, stakeholder concerns, and cost. The maximum anticipated area of scour protection per foundation type is provided in Table 3.3.5-2.

3.3.6 Offshore Converter Station

The purpose of the OCS–DC is to collect the power generated by the WTGs, transform it to a higher voltage for transmission, and transport that power to the Project's onshore electrical infrastructure (via the SRWEC). The design of the OCS–DC is described below. As described in Section 3.3.5.1, the OCS–DC will be installed on a piled jacket foundation.

Though the OCS–DC will be unmanned, additional facilities on the OCS–DC include break rooms, bathrooms, locker facilities, and general storage rooms for staff and equipment. There will not be any running water facilities on the platform and wastewater will be collected in holding tanks and removed by transfer to a crew transfer vessel (CTV) or services operations vessel (SOV). Solid waste will also be removed by a CTV or a SOV and brought to shore for proper disposal.

Appropriate safety systems will be included on the OCS–DC, including fire alarm and fire suppression systems, first aid and lifesaving equipment, emergency power supply, and lightning protection. The OCS–DC will not be manned; however, once functional, the OCS–DC will be subject to periodic O&M. Access to the OCS–DC will be provided from a boat landing or potentially a helicopter with a helideck located onsite. The boat landing located at the OCS–DC substructure provides access to the cable deck via a staircase and an intruder cage, to prevent unauthorized access to the OCS–DC. In case of emergency on the OCS–DC, the platform can be abandoned by means of life rafts. There will be an emergency room on the platform to house O&M staff in case of inclement weather.

The OCS–DC will be lit and marked in accordance with FAA, BOEM, and USCG requirements for aviation and navigation obstruction lighting, respectively. The proposed lighting and marking for the OCS–DC is presented in Section 3.5.7. The lights will be equipped with back-up battery power, as well as an emergency power supply, to maintain operation should a power outage occur on an OCS–DC. Additional detail regarding Project safety systems and equipment is provided in Appendix E2.

CONSTRUCTION AND OPERATIONS PLAN

Description of Proposed Activity – Project Design and Construction Activities

3.3.6.1 Design

An Offshore Converter Station (OCS–DC) will be required to support the Project's maximum design capacity. The water depth at the OCS–DC location will be approximately 164 ft (50 m) MSL based on NOAA Coastal Relief Model data (166 ft [51 m] mean lower low water [MLLW] based on site-specific geophysical surveys). The OCS–DC will convert the medium voltage AC generated by WTGs and transported to the OCS–DC via the IAC to DC for transmission to the onshore electrical infrastructure to reduce the energy losses that incur while transmitting energy over a long distance. Onshore, the OnCS–DC would convert the DC back to AC for interconnection to the electrical grid.

The OCS will house DC equipment. The DC equipment on the OCS–DC is expected to be rated up to ± 320 kV DC. The OCS–DC will house equipment for high-voltage transmission and conversion of electric power from alternating current (AC) to direct current (DC). The main equipment includes medium voltage AC (66-kV) gas-insulated switchgear, one or more converter transformers, and converter reactors. The OCS–DC would also include AC and DC gas- or air-insulated switchgears at voltages to be defined during detailed design, converter valves based on state-of-art voltage-source converter technology, DC smoothing reactors, and SCADA and protection systems.

In addition to the power transmission system above, the OCS–DC will be equipped with the necessary low voltage (LV) and utility systems. These systems include emergency power generation and uninterrupted power supply (UPS) seawater cooling, offshore crane, fire and safety, small power and lighting, and communications, sanitary facilities, and lifesaving and rescue. A helideck may also be located on the OCS–DC. The OCS–DC will also be designed to support select measurement equipment, as further described in Section 3.3.9.

The AC to DC conversion process at the OCS–DC requires a CWIS. Raw seawater for the OCS–DC will be withdrawn through three individual vertical pipes attached to a leg of the steel foundation jacket. The openings of each of the three intake pipes are located at a height 30 ft (10 m) above the seafloor. A seawater lift pump (SWLP) equipped with a variable frequency drive is dedicated to each of the three vertical intake pipes. The three SWLPs will pump water into a single manifold that leads into a coarse filtering element that is designed to remove suspended particles larger than 500 microns. The filtered cooling water will then be exposed to heat exchange equipment and ultimately discharged back to the source water through a dump caisson. The dump caisson is a single vertical pipe whose terminus is located 40 ft (12 m) below MSL. Additional design details will be included in the NPDES permit application, which is expected to be submitted in Q4 2021. The maximum topside design scenario for the OCS–DC is provided in Table 3.3.6-1.

CONSTRUCTION AND OPERATIONS PLAN

Description of Proposed Activity – Project Design and Construction Activities

Table 3.3.6-1 OCS–DC Maximum Topside Design Scenario

OCS DC Parameters	Maximum Design Scenario
OCS–DC Parameters	
Number of OCSs	1
Topside – main structure length and width	328 ft x 262 ft (100.0 m x 80.0 m)
Topside – main structure height	197 ft (60.0 m)
Air gap (MHHW to bottom of topside)	78 ft (23.8 m)
Topside height above LAT (excluding lightning protection)	295 ft (90.0 m)
Total structure height from LAT (including lightning protection & ancillary structures)	361 ft (110.0 m)
Topside weight	9,500 mT

The OCS–DC will require various oils, fuels, and lubricants to support its operation. Table 3.3.6-2 provides a summary of the maximum potential volumes of oils, fuels, and lubricants for the OCS–DC. The spill containment strategy for the OCS–DC is comprised of preventive, detective, and containment measures. The OCS–DC will be designed with a minimum of 110 percent of secondary containment of all identified oils, grease, and lubricants. These measures are discussed in more detail in Appendix E1. OCS–DC gas insulated switchgears containing SF₆ will be equipped with gas density monitoring devices to detect SF₆ gas leakages should they occur. Any chemicals used in the auxiliary systems will be brought onto and taken off the platform during O&M and are not anticipated to be stored on the platform.

Table 3.3.6-2 Summary of Maximum Potential Volumes Oils, Fuels, Gases and Lubricants for OCS–DC

OCS DC Equipment	Oil/Fuel/Gas Type	Oil/Fuel/Gas Volume
Transformers and Reactors	Transformer Oil	105,700 gal (400,000 L)
Generator fuel tank	Diesel Fuel	24,304 gal (92,000 L)
Medium and High-Voltage Gas-insulated Switchgears	Sulfur Hexafluoride (SF ₆)	3,960 lbs (1,796 kg)
Crane	Hydraulic Oil	528 gal (2,000 L)
Crane ¹	Grease	TBD
Rotating Equipment ¹	Lube Oil	TBD
Auxiliary Diesel Generator	Lube Oil	53 gal (200 L)
Seawater Lift Pumps	Lube Oil	119 gal (450 L)
Auxiliary Inert Gas System	High Pressure Nitrogen	52,834 gal (200,000 L), at 300 bar
Auxiliary Diesel Generator Fire Suppression System ¹	Inert Gas	TBD
Auxiliary Transformers	Synthetic Ester Oil	3,170 gal (12,000 L)
Chiller units	Refrigerant HFO1234ze(E)	40 gal (150 L)
Compressed Air Foam System ¹	Foam Concentrate	TBD
Uninterruptible Power Supply Battery ¹	Battery Acid	TBD

CONSTRUCTION AND OPERATIONS PLAN

Description of Proposed Activity – Project Design and Construction Activities

OCS DC Equipment	Oil/Fuel/Gas Type	Oil/Fuel/Gas Volume
Cooling Medium System	Glycol/Water Mix	7,925 gal (30,000 L)
Chilled Water Medium System	Glycol/Water Mix	5,283 gal (20,000 L)
NOTES: ¹ The volumes listed as “TBD” are pending further engineering and will be provided when the design is further progressed.		

3.3.6.2 Construction

The typical sequence for the OCS–DC installation is summarized in Table 3.3.6-3. The schedule for installation and commissioning of the OCS–DC is provided in Section 3.2, not including cable pull-in. Seafloor disturbance associated with installation of the OCS–DC is accounted for in Table 3.3.5-2, which summarizes disturbances associated with foundations.

Table 3.3.6-3 Typical Offshore Converter Station Construction Sequence

Activity/Action	Construction Details
Foundation Delivery and Installation	The OCS–DC will be supported by a piled jacket foundation. The foundation delivery and installation process is described in Table 3.3.5-4.
Topside Transport	Offshore platform components are typically transported directly from the fabrication yard via a heavy transport vessel or on a single transportation barge. If the OCS–DC components are fabricated in different locations, or if the OCS–DC is large (800 MW+), they may be transported on separate barges.
Topside Installation	The topside platform, including the transformer module and switchgear, will be assembled as a single unit prior to being transported to the Lease Area via a heavy transport vessel or barge. This expedites the lift of the module onto the foundation. The lift will commence using a suitable installation vessel and the topside platform will be lowered onto the pre-installed foundation. The topside is then secured into position by use of grouted, bolted, or welded connection. This step will occur following installation of the OCS–DC foundation.
Commissioning	Once the topside is secured to the foundation, the SRWEC and IAC will be connected. Communication systems will be set-up with the shore, as well as lighting, fire-fighting system, etc. Once all systems are enabled, the electrical systems will be commissioned using back-feed (i.e., electricity is fed to the OCS–DC from the onshore grid via the export cables). When completed, the OCS–DC is operational.

3.3.7 Inter-Array Cables

The IAC will carry the electrical current produced by the WTGs to the OCS–DC. The length of the entire network of IAC will be up to 186 mi (300 km). Figure 3.3.4-1 presents the indicative IAC layout for the Project. The following subsections describe the design and construction of the IAC.

CONSTRUCTION AND OPERATIONS PLAN

Description of Proposed Activity – Project Design and Construction Activities

3.3.7.1 Design

The network of AC IAC will be comprised of a series of cable “strings” that interconnect a small grouping of WTGs to the OCS–DC. The IAC will be installed within surveyed corridors ranging approximately 328 ft to 1,608 ft (100 m to 490 m) in width. The IAC will consist of three bundled copper or aluminum conductor cores surrounded by layers of cross-linked polyethylene or ethylene propylene rubber (EPR) insulation and various protective armoring and sheathing to protect the cable from external damage and keep it watertight. A fiber optic cable will also be included in the interstitial space between the three conductors and will be used to transmit data from each of the WTGs to the SCADA system. Table 3.3.7-1 provides a summary of the IAC maximum design scenario.

Table 3.3.7-1 Inter-Array Cable Maximum Design Scenario

Inter Array Cable Feature	Maximum Design Scenario
Voltage	66 - 161 kV
Cable Diameter	8 in (200 mm)
Approximate Total Length a/	186 mi (300 km)
Survey Corridor Width per circuit	328 ft to 1,608 ft (100 m to 490 m)
Construction Corridor Width per circuit b/	98 ft (30 m)
NOTES: a/ Maximum combined total of all cable strings. b/ Total cable installation area including areas where boulder clearance and/or sand wave removal may need to be removed and any associated additional cable protection requirements.	

3.3.7.2 Construction

The IAC will be installed within a 148-ft (45-m)-wide corridor. Burial of the IAC will typically target a depth of 3 to 7 ft (1 to 2 m). The target burial depth for the IAC will be determined based on an assessment of seafloor conditions, seafloor mobility, the risk of interaction with external hazards such as fishing gear and vessel anchors, and a site-specific Cable Burial Risk Assessment. Installation of the IAC will follow a similar sequence as described for the SRWEC in Table 3.3.3-4, with two exceptions:

- After pre-lay cable surveys and seafloor preparation activities are completed, a cable-laying vessel will be pre-loaded with the IAC. Prior to the first end-pull, the cable will be fitted with a cable protection system and the cable will be pulled into the WTG or OCS–DC. The vessel will then move towards the second WTG (or the OCS–DC). Cable may be laid on the seafloor and then trenched post-lay or, alternatively, cable laying and burial may occur simultaneously using a lay and bury tool. Alternatively, a trench may be pre-cut prior to cable installation. The pull and lay operation, inclusive of fitting the cable with a cable protection system, is then repeated for the remaining IAC lengths, connecting the WTGs and the OCS–DC together.
- The IAC will typically not require in-field joints; thus, “Joint Construction,” as described for the SRWEC, will generally not be required. However, joints may be required in case of a cable repair.

CONSTRUCTION AND OPERATIONS PLAN

Description of Proposed Activity – Project Design and Construction Activities

Installation methods for the IAC will be similar to those described for the SRWEC (see Section 3.3.3.4). As described for the installation of the SRWEC, seafloor preparation (specifically boulder clearance and sand wave leveling) will be required; boulder clearance trials, as previously described for the SRWEC, may also be implemented prior to wide-scale seafloor preparation activities. Sunrise Wind assumes up to 10 percent of the total IAC network will require boulder clearance and up to 5 percent of the total IAC network will require sand wave leveling prior to installation of the cables. As with the SRWEC, boulder clearance will involve the use of a boulder grab or towed plow to relocate boulders along the IAC routes. The installation and commissioning of the IAC system is presented in the construction schedule provided in Section 3.2.

Cable protection strategies will be required for the IAC. Sunrise Wind assumes up to 15 percent of the entire IAC network may require secondary cable protection in areas where burial cannot occur, sufficient burial depth cannot be achieved due to seafloor conditions, or to avoid risk of interaction with external hazards. As previously described in Section 3.3.5, additional CPS stabilization may be used where the IACs are pulled into the foundations. As previously described in Section 3.3.3.4 (Cable Crossings), the SRWEC and IAC will also need to cross existing cables, which will require cable protection. The anticipated locations where IAC will cross existing cables is provided in Table 3.3.3-6. As previously described, rock berm or concrete mattress separation layers will be installed over the previously installed cable prior to installing a crossing cable, while the rock berm or concrete mattress cover layers will be installed after cable installation. The location of the IAC and associated cable protection will be provided to NOAA's Office of Coast Survey after installation is completed so that they may be marked on nautical charts.

The installation methods and burial depths will be determined by the engineering design process, informed by detailed geotechnical data, discussion with the chosen installation contractor, and coordination with regulatory agencies and stakeholders. Detailed information on the technique(s) selected, burial requirements, and the Cable Burial Risk Assessment will be included in the FDR/FIR, to be reviewed by the CVA and submitted to BOEM prior to construction. The *Cable Burial Feasibility Assessment*, based on review of site-specific survey data, is provided with the MSIR as Appendix G4.

Maximum seafloor disturbance associated with construction and operation of the IAC is summarized in Table 3.3.7-2

CONSTRUCTION AND OPERATIONS PLAN

Description of Proposed Activity – Project Design and Construction Activities

Table 3.3.7-2 Maximum Inter-Array Cable Seafloor Disturbance

Parameter	Maximum Area of Disturbance
IAC General Disturbance Corridor a/	2,224 ac (900 ha)
Boulder Clearance b/	222 ac (90 ha)
Sand wave Leveling c/	111 ac (45 ha)
Secondary Cable Protection d/	133 ac (54 ha)
Cable Crossing Protection of Existing Cables e/	7.4 ac (3.0 ha)
<p>NOTES:</p> <p>a/ Total IAC network length x 30 m wide corridor per cable. Boulder clearance, sand wave leveling, and cable protection will not extend beyond this corridor.</p> <p>b/ Assumes 10% of Inter-Array Cable Corridor may be cleared of boulders (total IAC network length x 0.1 x 30 m)</p> <p>c/ Assumes 5% of Inter-Array Cable Corridor may be cleared of sand waves (total IAC network length x 0.05 x 30 m).</p> <p>d/ Assumes 15% of Inter-Array Cables may require cable protection. Secondary protection will be up to 39 ft (12 m) wide (Total IAC network length x 0.15 x 12 m). Includes area where additional protection may be required post-installation. This number is not inclusive of the CPS stabilization previously described in Section 3.3.5.</p> <p>e/ Assumes 5 known crossings requiring additional protection with a maximum area of 1.48 acres (0.6 ha) of seafloor disturbance per cable crossing.</p>	

3.3.8 Wind Turbine Generators

The Project will consist of up to 122 WTGs, sited in a uniform east-west/north-south grid with 1.15 by 1.15-mi (1 by 1-nm; 1.85 by 1.85-km) spacing (see Section 3.3.4 and Figure 3.3.4-1). The water depths where the WTGs will be located range from 135 to 190 ft (41 to 58 m) MSL, based on NOAA Coastal Relief Model data (115 to 203 ft [35 to 62 m] MLLW based on site-specific geophysical surveys). As previously noted, a final layout of the Project will be provided as part of the FDR/FIR, to be reviewed by the CVA and submitted to BOEM prior to construction. Design and installation of the WTGs are described further in the following subsections.

3.3.8.1 Design

Sunrise Wind requires flexibility in WTG choice to anticipate advancements in the available WTG technology. Sunrise Wind will select the WTG model that is best suited for the Project and that is commercially available to support the Project schedule. The selected WTG model and nameplate capacity will ultimately determine the number of WTGs. WTGs being considered range in nameplate capacity between 8 and 15 MW.

While a range of WTG models from various suppliers may be considered, all WTGs for the Project are expected to follow the traditional offshore WTG design with three blades and a horizontal rotor axis. Specifically, the blades will be connected to a central hub, forming a rotor that turns a shaft connected to the generator or gearbox (if required). The generator and gearbox¹³ will be located within a containing structure known as the nacelle situated adjacent to the rotor hub. The nacelle will be supported by a tower structure affixed to the foundation. The nacelle will be able to rotate or “yaw” on the vertical axis to face the oncoming wind direction.

¹³ If applicable; some WTG models do not have a gearbox.

CONSTRUCTION AND OPERATIONS PLAN

Description of Proposed Activity – Project Design and Construction Activities

Figure 3.3.8-1 shows a conceptual rendering of the WTGs with the maximum and minimum representative dimensions provided.

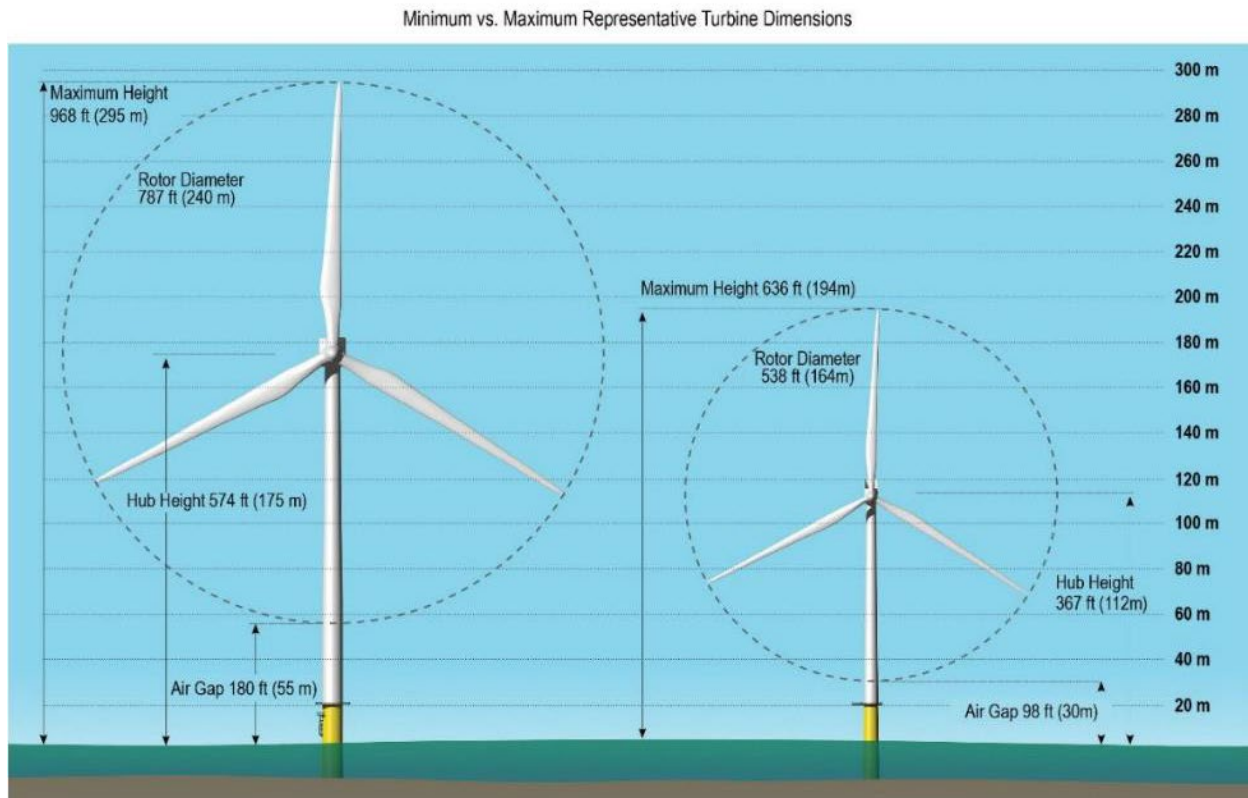

Figure 3.3.8-1 Conceptual Rendering of the Minimum and Maximum WTGs under Consideration

In support of the development of the Project, Sunrise Wind is evaluating a range of WTG sizes. For the purpose of the assessments presented within this COP, the WTG design envelope has been defined by minimum and maximum parameters that are representative of the WTGs currently on the market or expected to become available in time to be used for the Project based on ongoing discussions with suppliers.

Table 3.3.8-1 provides a summary of the indicative minimum and maximum physical parameters of the WTG design scenarios under consideration for the Project. The WTGs will be designed following Class I-B specifications of the standards IEC-61400-1/IEC-61400-3. The design is specifically suited for offshore wind sites with referenced wind speeds of 112 miles per hour (mph) (50 meters per second [m/s] over a 10-minute average) and 50-year extreme gusts of 157 mph (70 m/s over a 3-second average) as well as air temperatures greater than -4 degrees Fahrenheit (°F) (-20 degrees Celsius [°C]) and less than 122° F (50°C). However, standard environmental operating conditions for the proposed WTGs include cut-in wind speeds of 7 to 11 mph (3 to 5 m/s) and cut-out wind speeds of 55–80 mph (25–35 m/s), and air temperatures between 14°F and 104° F (-20°C and +40°C). The WTGs will automatically shut down outside of the operational criterion for the WTG design.

CONSTRUCTION AND OPERATIONS PLAN

Description of Proposed Activity – Project Design and Construction Activities

The WTGs will also be designed to minimize the effects of potential icing conditions in the SRWF. In addition, the SCADA monitoring system and turbine control management system are designed to detect the buildup of ice and/or snow on the WTG and shut down operations, as necessary.

The WTGs will be type certified according to IEC standards. The WTGs will comply with EC machinery directive (CE marked). Sunrise Wind will seek compliance with American Wind Energy Association (AWEA) Offshore Compliance Recommended Practices (2012) and future revisions as well as BOEM and BSEE regulations that directly govern operations and in-service inspections for offshore wind facilities in the US.

Table 3.3.8-1 WTG Design Envelope Specifications

WTG Component/Parameter	Minimum (8 MW)	Maximum (15 MW)
Turbine Height (from MSL) a/	636 ft (194 m)	968 ft (295 m)
Hub Height (from MSL) a/	367 ft (112 m)	574 ft (175 m)
Air Gap (from MSL) to the Bottom of the Blade Tip a/	98 ft (30 m)	180 ft (55 m)
Base Height (foundation height – top of TP) (from MSL) a/	79 ft (24 m)	98 ft (30 m)
Base (tower) Width (at the bottom)	20 ft (6 m)	30 ft (9 m)
Base (tower) Width (at the top)	13 ft (4 m)	23 ft (7 m)
Nacelle Dimensions (length x width x height)	39 ft x 23 ft x 20 ft (12 m x 7 m x 6 m)	82 ft x 36 ft x 39 ft (25 m x 11 m x 12 m)
Blade Length	262 ft (80 m)	377 ft (115 m)
Maximum Blade Width	16 ft (5 m)	30 ft (9 m)
Rotor Diameter	538 ft (164 m)	787 ft (240 m)
Operation Cut-in Wind Speed	7 to 11 mph (3 to 5 m/s)	
Operational Cut-out Wind Speed	55 to 80 mph (25 to 35 m/s)	
NOTES: a/ MSL = Mean Sea Level		

Each of the WTGs will require various oils, fuels, and lubricants to support the operation of the WTGs; SF6 may also be used for insulation purposes. Table 3.3.8-2 provides a summary of the maximum potential quantities of oils, fuels, lubricants, and SF6 per WTG. The spill containment strategy for each WTG is comprised of preventive, detective, and containment measures. These measures include 100 percent leakage-free joints to prevent leaks at the connectors; high pressure and oil level sensors that can detect both water and oil leakage; and appropriate integrated retention reservoirs capable of containing 110 percent of the volume of potential leakages at each WTG. Additionally, WTG switchgear containing SF6 will be equipped with integral low-pressure detectors to detect SF6 gas leakages should they occur.

CONSTRUCTION AND OPERATIONS PLAN

Description of Proposed Activity – Project Design and Construction Activities

Table 3.3.8-2 Summary of Maximum Potential Volumes Oils, Fuels, Gases and Lubricants per WTG

WTG System/Component	Oil/Fuel/Gas Type	Oil/Fuel/Gas Volume
WTG Bearings and Yaw Pinions	Grease a/	343 gal (1,300 L)
Hydraulic Pumping Unit, Hydraulic Pitch Actuators, Hydraulic Pitch Accumulators	Hydraulic Oil	528 gal (2,000 L)
Drive Train Gearbox (if applicable), Yaw Drives Gearbox	Gear Oil	582 gal (2,200 L)
Blades and Generator Accumulators	Nitrogen	104 cubic yd (80 m ³)
High-Voltage Transformer	Transformer Silicon/Ester Oil	1,850 gal (7,000 L)
Emergency Generator b/	Diesel Fuel	793 gal (3,000 L)
Switchgear	Sulfur Hexafluoride (SF ₆)	13 lbs (6 kg)
Tower Damper and Cooling System	Glycol/Coolants	3,434 gal (13,000 L)
<p>NOTES:</p> <p>a/ Approximately 26 gal to 40 gal (100 L to 150 L) per large bearing.</p> <p>b/ Emergency generator is not housed on the WTG but would be brought to the WTG during commissioning or in an emergency power outage.</p>		

Each WTG will have its own control system to carry out functions like yaw control and ramp down in high wind speeds. Each turbine will also connect to a central SCADA system for control of the wind farm remotely. This allows functions such as remote turbine shutdown if faults occur. The Project will be able to shut down a WTG within two minutes of initiating a shutdown signal. The SCADA system will communicate with the wind farm via fiber optic cable(s), microwave, or satellite links. Individual WTGs can also be controlled manually from within the nacelle or tower base to control and/or lock out the WTG during commissioning or maintenance activities. In case of a power outage or during commissioning, the turbine may be powered by a permanent battery back-up power solution with integrated energy harvest from the rotor or by a diesel generator located temporarily on each WTG.

The WTGs will also be protected both externally and internally by a lightning protection system. The external lightning protection system is comprised of lightning receptors located within both the nacelle and blade tips, which are designed to handle direct lightning strikes and will conduct the lightning's peak current through a conductive cabling system that leads through the tower into the WTG grounding/earthing system. To avoid and/or minimize internal damage from the secondary effects of lightning (e.g., power surges), the internal electrical systems will be protected by equipotential bonding, overvoltage protection, and electromagnetic coordination.

WTGs may be accessed either from a vessel via a boat landing or alternative means of safe access (e.g., Get Up Safe). The WTGs will be lit and marked in accordance with FAA, BOEM, and USCG requirements for aviation and navigation obstruction lighting, respectively. The lights will be equipped with back-up battery power to maintain operation should a power outage occur on a WTG. Additional operational safety systems on each WTG include fire suppression, first aid, and survival equipment.

CONSTRUCTION AND OPERATIONS PLAN

Description of Proposed Activity – Project Design and Construction Activities

The WTGs will each be lit, individually marked, and maintained as PATONs in accordance with the guidance provided in the Aids to Navigation Manual (USCG 2015) and will also comply with International Association of Marine Aids to Navigation and Lighthouse Authorities (IALA) Recommendation O-139 on The Marking of Man-Made Offshore Structures (IALA 2013) and recently proposed BOEM guidance on marking and lighting of offshore wind farms (84 FR 57471), pursuant to agreement with the USCG and BOEM. Sunrise Wind may also install AIS on select WTGs.

Additionally, Sunrise Wind will also light and mark all WTGs in accordance with FAA Advisory Circular 70/7460-1L (2018), as recommended by BOEM's recently draft proposed guidance on marking and lighting of offshore wind farms (BOEM 2019). Select WTG(s) may also be designed to support measurement equipment, as further described in Section 3.3.9.

Finally, the Project is evaluating the implementation of methods to limit the visual impact of the aviation light, for example light dimming or the use of a radar-based Aircraft Detection Lighting System (ADLS) to turn on, and off, the aviation obstruction lights in response to detection of aircraft in proximity to the SRWF. Sunrise Wind will use ADLS or related means (e.g., dimming or shielding) to limit visual impact, pursuant to approval by the FAA and BOEM and commercial and technical feasibility at the time of FDR/FIR approval.

3.3.8.2 Construction

The typical sequence for WTG installation is summarized in Table 3.3.8-3.

Table 3.3.8-3 Typical WTG Construction Sequence

Activity/Action	Construction Details
Transport	WTG components will be transported to the laydown construction port to prepare components for loading and installation. Activities include pre-assembling tower sections, as well as preparing the nacelles, blades, and equipment necessary for WTG installation. The WTGs are anticipated to be transported to the Lease Area by either an installation vessel or feeder vessel.
WTG Towers	Once positioned, the installation vessel will install the tower either as a single lift if pre-assembled, or in multiple lifts for separate sections. The tower is then bolted to the foundation.
WTG Nacelle	Installation vessel then installs nacelle on top of the tower and secures it with bolts.
WTG Blades	Blades are installed either as a pre-assembled full rotor or in single lifts.
Commissioning	Once the WTG installation is complete the installation vessel will move on to the next installation location. Commissioning of the turbine can be executed by commissioning technicians working from separate commissioning vessels or from the WTG installation vessel.

It is currently estimated that the construction of each WTG may take up to 36 hours allowing for vessel positioning and completion of all lifts; however, to allow time for vessel maneuvering between WTG locations as well as weather downtime, the total duration of the installation campaign for the WTGs is presented in see Section 3.2.

Vessel activity during installation of WTGs will occur within area cleared during seafloor preparations as described in Section 3.3.6. Seafloor disturbance associated with installation of WTGs will result from jack-up vessel spudcans. Seafloor disturbance associated with WTG foundations is summarized in Table 3.3.5-2.

CONSTRUCTION AND OPERATIONS PLAN

Description of Proposed Activity – Project Design and Construction Activities

3.3.9 Measurement Equipment

Sunrise Wind plans to install a series of monitoring instrumentation to monitor metocean conditions as part of the Project's construction and operation activities. The monitoring instrumentation may consist of a floating light detection and ranging (flidar), wave buoys, Acoustic Doppler Current Profiler (ADCP), ground-based lidar, wave radar sensor, and weather stations measuring air temperature, air pressure, humidity, wind speed and direction, and visibility readings. Each type of measurement equipment is described below in further detail.

3.3.9.1 Flidar

A single flidar may be installed in the Lease Area prior to or during the construction to measure blockage and wake effects from the South Fork Wind Farm and Revolution Wind Farm. The flidar will be maintained through construction and will provide real time data for the vessels operating offshore to support lifting operation, cargo transfer, and overall weather monitoring for logistics decisions. The position where the flidar may be located in the Lease Area will be identified at a later date and a Site Assessment Plan (SAP) will be submitted to BOEM at that time.

The flidar will consist of a floating platform with sensors and equipment that measure ocean parameters and atmospheric conditions, including wind velocity. The flidar will be anchored to the seabed with an anchor or weight block and chain and the buoy will weather vane with the waves, wind and tides. The anchoring and mooring system will be designed to withstand the loads and site conditions for the 10-year return period storm. The flidar will be powered using a set of external wind turbines, solar panels, internal batteries, and diesel generators or fuel cells that work as per a hierarchy order. The flidar is generally equipped with satellite data transmission options that transmit data to an onshore server. Deployment of the flidar would occur from a vessel and would be conducted in accordance with manufacturer specifications by trained personnel. Additional details on the flidar will be provided in the SAP to be submitted to BOEM.

3.3.9.2 Wave Buoys

Up to two wave buoys will be deployed to support the SRWF installation stage with one wave buoy within the SRWF proximate to the WTGs in the eastern region of the windfarm and one wave buoy deployed nearshore along the SRWEC–NYS near the HDD exit pit location. The wave buoys will collect information about the wave and current information to be transmitted in real time to the installation vessel(s) for monitoring the safety of operations and also to feed into a forecasting system for real time calibration and accuracy improvement of the local forecast. The number and exact coordinates of the wave buoys will be determined at a later date. The wave buoys would be installed during the construction phase. The nearshore wave buoy will only remain deployed during the cable installation process. The wave buoy in the SRWF would remain in place during the installation works and may remain deployed in the water after windfarm commissioning, until Sunrise Wind has reviewed and confirmed calibration of the data. During the operations phase, the wave radar sensor, together with the weather and wave forecast service, would support asset management, structural monitoring, and marine transfer operations. Data collected will be stored locally and transmitted via telemetry to a satellite gateway to an onshore server.

CONSTRUCTION AND OPERATIONS PLAN

Description of Proposed Activity – Project Design and Construction Activities

The wave buoys will measure wave heights, periods, and directions and may also be equipped with a downward facing current profiler, which measures water velocity and direction through the water column. The top side of the wave buoy is comprised of a tall mast (7 feet above sea level approx.) where a set of equipment is fixed: navigational light, navigation radar, solar panels, antenna, visibility sensors and ultra-sonic anemometer. Generally, wave buoy diameters range from 1.6 to over 5 ft (0.5 to over 1.5 m) and range in weight from 440 to 1,320 lbs (200 to 600 kg). The mooring configuration will be dependent on buoy type, water depth, and environmental considerations, but generally consists of an anchor weight (approximately 11 ft² [1 m²] and 1,765 lbs [800 kg]), mooring line, and are equipped with navigational lighting. The wave buoys would be powered by lead acid and lithium batteries that are charged through solar panels but would operate using only solar power when available. Deployment of the wave buoys would occur from vessels equipped with a crane or A-Frame and winch and would be conducted in accordance with manufacturer specifications by trained personnel.

3.3.9.3 Acoustic Doppler Current Profiler

Up to two near-shore ADCPs will be deployed during construction in the nearshore area in the vicinity of the HDD exit pit and along the cable route to support cable installation activities. Any ADCPs deployed will only be used during the installation period and recovery of the ADCPs would occur within a few months of installation completion. ADCPs collect current measurements, including direction and velocity through the water column by sending pulses through the water column at varying frequencies. This data may be stored internally and transferred upon equipment recovery or, for real-time monitoring, the data may be transmitted via telemetry to a satellite gateway to an onshore server using a transmission buoy. The number and locations of ADCPs will be determined as the cable route, seabed conditions, and ocean dynamics are further defined and in coordination with stakeholders.

The adopted ADCP configuration could consist of two solutions:

- An upward facing ADCP mounted on a seabed frame, a groundline connecting the frame to the ground weight, and a data storage/recovery system. The groundline will be relatively taut, with generally no sweep occurring throughout the tides. The seabed frame has an approximately 11 ft² (1 m²) footprint. It is 1.6 to 3.3 ft (0.5 to 1 m) in height and weighs 220 to 1,100 lbs (100 to 500 kg). The frame may consist of simple tripod designs with gimbal and/or trawl resistant features such as low profile and protected sides. ADCPs are powered by alkaline or lithium batteries. There are two standard mooring configurations that may be used. One includes a surface marker buoy that can be used for telemetry in real time and navigation and acts as the primary recovery method. If used, the marker buoy may be affixed to the ground weight by chain or rope mooring. The second configuration does not have a surface marker and relies on an acoustic system to release floats, which are attached to the ADCP frame. ADCP deployment will be conducted in accordance with manufacturer specifications by trained personnel.

Deployment and recovery of ADCP frames and moorings can generally be conducted on a small workboat or cat equipped with on-deck crane, winch, and bow roller.

- An alternative setup is using a standard wave buoy (as described in Section 3.3.9.2), and installing a bottom-mounted ADCP to the lower part of the submerged hull of the buoy.

CONSTRUCTION AND OPERATIONS PLAN

Description of Proposed Activity – Project Design and Construction Activities

3.3.9.4 Ground Based Lidar

The lidar wind measurements will be taken using ground-based lidars and anemometers. During construction, ground-based lidar includes LiDAR installation at some ports, on decks of installation of work vessels, or on the OCS–DC.

The lidars used for some port facilities and installation on work vessels are aimed at supporting lifting operations to ensure safety and to minimize risk to equipment, vessels, and crew.

There will be:

- 3 lidars at different ports (specific locations to be confirmed)
- 2 lidars on two installation vessels (foundation vessel and WTG vessel)

The OCS–DC lidar is not yet confirmed. The design for the OCS–DC may include a lidar mount and connection point to support potential installation of a sensor.

3.3.9.5 Wave Radar Sensors

Up to one directional wave radar sensor will be installed in the SRWF located at the OCS–DC. This will be installed when the OCS–DC is energized and will stay in place for the entire operational life of the windfarm.

3.3.9.6 Weather Stations

Weather stations with anemometers will be installed on the OCS–DC and selected WTG(s) as per NYISO requirements. The units to be placed on the OCS–DC shall be part of a single weather station installed in the roof of the upper level of the converter station. The weather station will include measurements of air temperature; air pressure; humidity; visibility; and wind speed and direction.

CONSTRUCTION AND OPERATIONS PLAN

Description of Proposed Activity – Project Design and Construction Activities

3.3.10 Ports, Vessels and Vehicles, Material Transportation, Chemical and Waste Management, and Construction Work Zones

Sunrise Wind is evaluating the potential use of several existing port facilities located in New York, Connecticut, and Rhode Island to support offshore construction, assembly and fabrication, crew transfer and logistics, as further described below. Sunrise Wind is also considering backup options, as briefly summarized below and listed in Table 3.3.10-1 and Figure 3.3.10-1. At this time no final determination has been made concerning the specific location(s) of these activities. Several existing port facilities would require no upgrades or modifications for use in connection with the Project. And, to the extent that upgrades or modifications at an existing port facility may occur, such work would either (1) be permitted and undertaken by port owners/operators and/or governmental or quasi-governmental entities in conjunction with state economic development initiatives relating to the broader US offshore wind industry or (2) evaluated as part of BOEM's review of other projects being developed by Sunrise Wind's fellow subsidiaries of North East Offshore, LLC (i.e., the South Fork Wind Farm and/or the Revolution Wind Farm). Whether or not upgrades are required, construction port facilities are expected to serve multiple offshore wind projects, and potentially multiple offshore wind related and other maritime industries. Given that these construction ports are intended to serve the US offshore wind industry as a whole, and not the Project or North East Offshore, LLC's subsidiaries specifically, they have independent utility from the Project.

As stated, the primary construction ports that are expected to be used during construction are as follows:

- **Albany and/or Coeymans, NY:** Foundation scope. Either of these construction port areas could be used to support fabrication and assembly of secondary-steel foundation components, as well as staging and load-out operations in collaboration with a key subcontractor. No upgrades or modifications are anticipated to either facility in connection with the Project (other than *de minimis* measures such as the potential use of temporary facilities) because both facilities are already suitable for the contemplated activities. But Sunrise Wind understands that upgrades to serve the US offshore wind industry are currently contemplated. For instance, the Port of Albany has announced upgrades that include an offshore wind tower factory; and the owner of the Port of Coeymans has submitted a permit application to NYSDEC and USACE for offshore wind-related upgrades, including in conjunction with New York State's most recent offshore wind solicitation. Sunrise Wind understands that the permitting process includes Section 106 consultation and consultation with the New York State Historic Preservation Office (NYSHPO).

CONSTRUCTION AND OPERATIONS PLAN

Description of Proposed Activity – Project Design and Construction Activities

- **Port of New London, CT:** WTG scope. This construction port is intended to support the staging, pre-assembly and load-out of the nacelle units, the tower sections and the blades. Upgrades at the Port of New London are being permitted, and will be undertaken, by the Connecticut Port Authority. Sunrise Wind understands that the permitting process requires approvals from both the Connecticut Department of Energy and Environmental Protection (CT DEEP) and the USACE, and includes consultation with the Connecticut SHPO pursuant to Section 106. The upgrades are intended to serve the US offshore wind industry as a whole, while maintaining and improving utility for other maritime industries (including fishing and break bulk cargo). Other offshore wind developers beyond Sunrise Wind and its affiliates are expected to have the opportunity to use the construction port.
- **Port of Davisville-Quonset Point, RI:** Construction Management Base. This construction port is intended to support the berthing and sheltering of CTVs, as well as the onshore office and warehouse facilities required to support the offshore installation activities. In addition to its potential role as a construction port, the Port of Davisville-Quonset Point, RI is being considered for use as an operations and maintenance facility for both the Project and for North East Offshore, LLC subsidiary South Fork Wind LLC's South Fork Wind Farm Project. All necessary upgrades are described in Section 3.5.5 below and are being analyzed in BOEM's ongoing review of the South Fork Wind Farm Project.

Other construction ports may be used as back-up or support facilities if they become preferable to the primary port facilities, or if Sunrise Wind determines that additional scope is required (for example, using an existing port facility to support minor marshalling activities). These back-up options include the Port of New York-New Jersey, NY, the New Bedford Marine Commerce Terminal, MA, Sparrow's Point, MD, Paulsboro Marine Terminal, NJ, Port of Providence, RI and Port of Norfolk, VA. Upgrades at these facilities are for the most part not required for the purposes of the Project. To the extent that upgrades are made by port operators to support the US offshore wind industry or other maritime industries, Sunrise Wind may rely on such upgrades after the fact, but would have no involvement in them. A complete list of potential port facilities is provided in Table 3.3.10-1.

CONSTRUCTION AND OPERATIONS PLAN

Description of Proposed Activity – Project Design and Construction Activities

Table 3.3.10-1 Potential Port Facilities

State	Port	City/Town, County	Summary of Potential Activities				
			WTG Tower, Nacelle, and Blade Storage, Pre commissioning, and Marshalling	Foundation Marshalling and Advanced Foundation Component Fabrication	O&M Activities	Construction Base	Electrical Activities and Support
Connecticut	Port of New London	New London, New London County	•				
Massachusetts	New Bedford Marine Commerce Terminal	New Bedford, Bristol County	•				
Maryland	Sparrows Point	Sparrows Point, Baltimore County		•			
New Jersey	Paulsboro Marine Terminal	Paulsboro, Gloucester County		•			
New York	Port of Albany	Albany, Albany County		•			
	Port of Brooklyn	Brooklyn, Kings County			•		
	Port of Coeymans	Coeymans, Albany County		•			
	Port Jefferson	Port Jefferson Village, Suffolk County			•		
	Port of New York	New York City, New York County					•
	Port of Montauk	Montauk, Suffolk County			•		
Rhode Island	Port of Providence	Providence, Providence County	•	•			•
	Port of Davisville and Quonset Point	North Kingstown, Washington County			•	•	
	Port of Galilee	Narragansett, Washington County			•		
Virginia	Port of Norfolk	Norfolk, Norfolk County	•				

This page intentionally left blank

V:\1956\active_Task Owner and other Non-BC1956_Jobs\2028113199\03_data\gis_cad\gis\MKDs\COP\2028113199_3.3.10-1_PortFacility.mxd Revised: 2021-05-07 By: gcarpentier

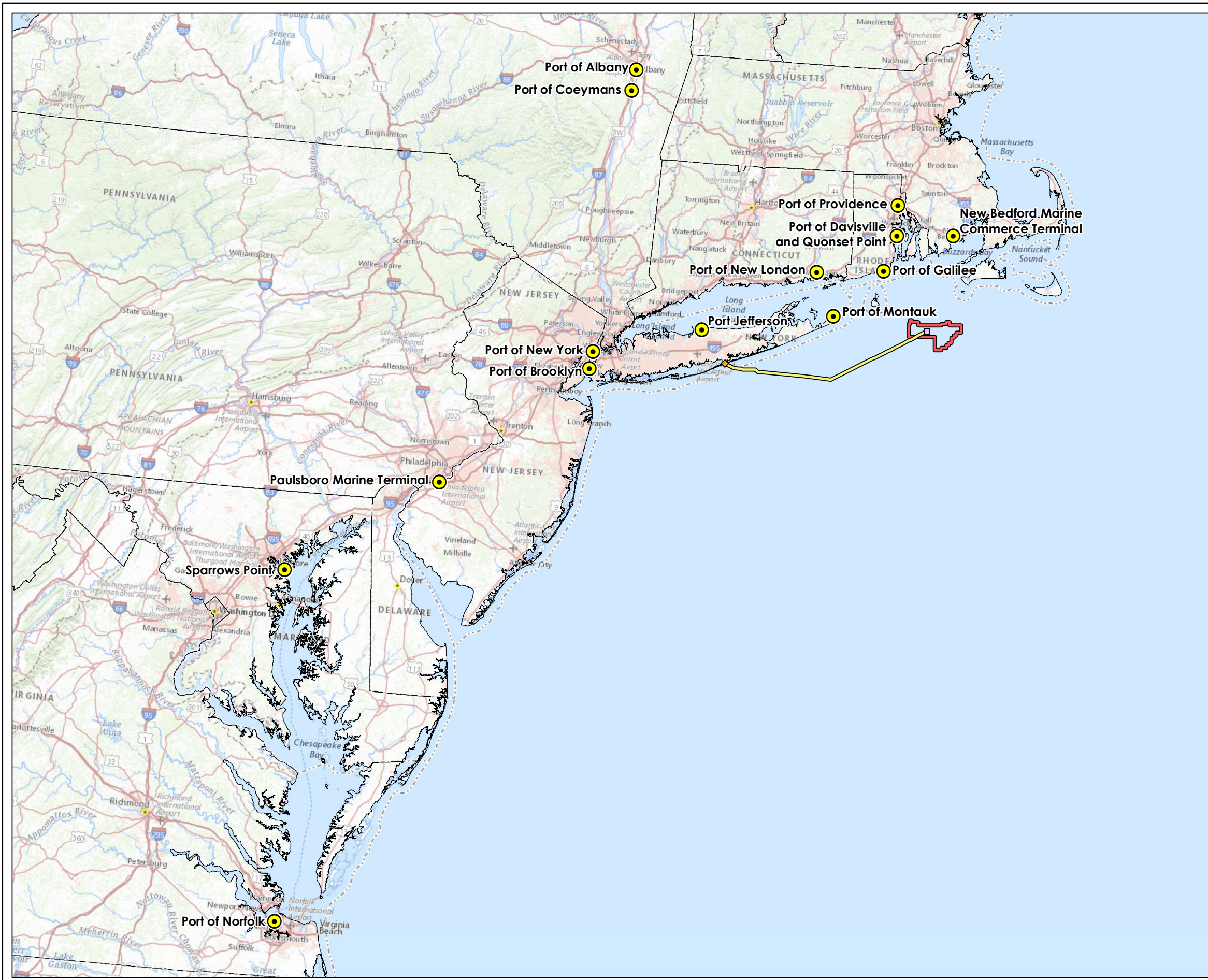

Figure 3.3.10-1
Location of Potential Port Facilities

Sunrise Wind | Powered by Ørsted & Eversource

- Legend**
- Sunrise Wind Farm (SRWF)
 - Offshore Converter Station (OCS-DC)
 - ◆ SRWEC Landfall Location
 - Sunrise Wind Export Cable (SRWEC)
 - Port Facility

Sources

1. BOEM, USACE
2. Base map: USGS The National Map

Date	09/01/2020 Revised: 12/18/2020
Project Number	2028113199
Prepared By	GC
Reviewed By	LJ

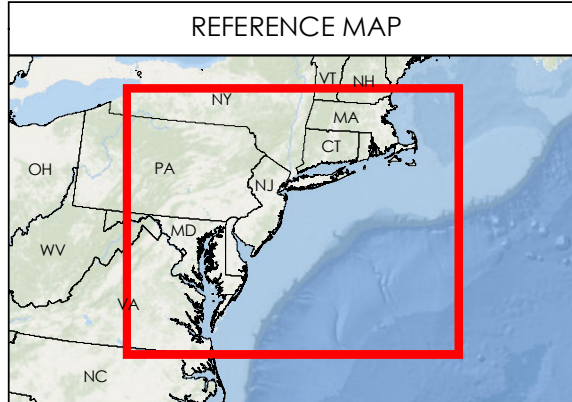
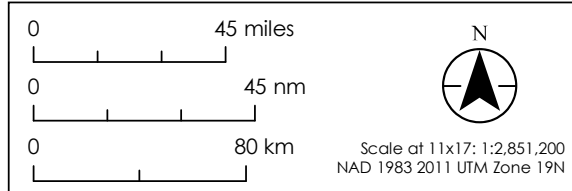

This page intentionally left blank

CONSTRUCTION AND OPERATIONS PLAN

Description of Proposed Activity – Project Design and Construction Activities

3.3.10.1 Vessels and Vehicles

Construction of the Project will require the support of onshore construction equipment (Table 3.3.10-2), as well as various vessels, helicopters, and unmanned systems (Table 3.3.10-3). For each vessel type, the route plan for the vessel operation area will be developed to meet industry guidelines and best practices in accordance with International Chamber of Shipping guidance. The Project will install operational AIS on all vessels associated with the construction of the Project. AIS will be used to monitor the number of vessels and traffic patterns for analysis and compliance with vessel speed requirements. All vessels will operate in accordance with applicable rules and regulations for maritime operation within US and federal waters. Similarly, all aviation operation, including flying routes and altitude, will be aligned with relevant stakeholders (e.g., the FAA). Additionally, the Project will adhere to current vessel speed restrictions as appropriate at the time of Project activities and in accordance with BOEM and NOAA Fisheries requirements.

Project vessels will employ a variety of anchoring systems, which include a range of size, weight, mooring systems, and penetration depths. Anchors associated with cable laying vessels will have a maximum penetration depth of 15 ft (4.6 m). Jack-up will include up to four spudcans with a maximum penetration depth of 52 ft (15.8 m). Jack up will occur within the 722-ft (220-m) radius cleared around foundation locations during seafloor preparation activities.

Safety of Project personnel, crew, and contractors is of the utmost importance to Sunrise Wind (see Appendices E1 and E2). In planning construction activities, Sunrise Wind will account for weather conditions that could affect the safety and efficiency of construction activities. As a general rule, all offshore work will be halted in wind conditions, lightning storms, and/or sea states that exceed Project operational limits as detailed in the SMS (Appendix E2).

Risk assessments or guidelines from equipment manufacturers may alter acceptable operating limits. As detailed in the Project's SMS, work may be stopped at any time for human/environmental health or safety reasons.

The ice season is a potential issue for workboats heading to and from the SRWF and SRWEC. As noted in Section 4.3.1, there is a potential for equipment and vessels above the water line to experience icing; however, sea ice is not a typical occurrence in the SRWF or SRWEC.

Low visibility conditions in the Project Area could also be a concern for work crews and vessels. Low visibility conditions due to fog are most common in summer months, with June being the highest risk at ten potential days of fog (see Affected Environment Section 4.3.1). Should any sea ice, icing on the vessel, and/or low visibility condition occur during the construction period or impact maritime navigation to the site, construction plans would be altered to avoid working under any conditions with the potential to compromise safety (see Appendix E1).

CONSTRUCTION AND OPERATIONS PLAN

Description of Proposed Activity – Project Design and Construction Activities

Table 3.3.10-2 Summary of Equipment to Support Onshore Construction

Equipment Type	# of Units	OnCS DC	Onshore Transmission Cable
AC units		•	
All-Terrain Forklift	1		•
Backhoe	3	•	
Blade Finisher	1	•	
Bobcat/ Skid Steer	8	•	•
Bucket Truck/large utility support vehicle	1	•	
Cable Puller	1	•	
Chipper	1	•	
Compactors	3	•	
Compressors	5	•	
Concrete Saws	6	•	
Concrete Truck	7	•	•
Concrete Vibrator	1		•
Drill Rig	1		•
Dump Truck	7	•	•
Feller/Buncher	1	•	
Front End Loader	2	•	•
Generator	1		•
Graders	1	•	
Hydraulic Tamper	1	•	
Large Aerial Lift	1	•	
Large Bulldozer	2	•	
Large Crane	1	•	
Large Excavator	1		•
Light Commercial Truck	8	•	
Log Truck	1	•	
Medium Aerial Lift	2	•	
Medium Crane	2	•	
Medium Excavator	2	•	
Passenger Truck	8	•	•
Pumps	9	•	•
Refuse Truck	2	•	
Roller	1	•	
Semi-Truck	5		•
Skidder	1	•	

CONSTRUCTION AND OPERATIONS PLAN

Description of Proposed Activity – Project Design and Construction Activities

Equipment Type	# of Units	OnCS DC	Onshore Transmission Cable
Small Bulldozer	3	•	
Small Crane	1	•	
Small Excavator	4	•	
Small Tractor	1	•	
Trenchers	1	•	
Welder	1		•
Work Truck	1	•	

Table 3.3.10-3 Summary of Vessels and Helicopters to Support Offshore Construction

Vessel Type	# of Vessels	Foundations	OCS DC	SRWEC	IAC	WTGs
Heavy Lift Installation Vessel	2	•	•			
Multi-Purpose Supply Vessel	3	•	•			
Heavy Transport Vessel	5		•			
Rock Dumping Vessel	2	•	•			
Bubble Curtain Vessel	2	•	•			
Fuel Bunkering Vessel	2	•	•			
Transportation Barge	3	•	•			
Escort Tug for Barge	3		•			
Towing Tug	6	•	•			•
Anchor Handling Tug	2	•	•	•		
Assisting tug	2					•
Platform Supply Vessel	1					•
Jack-Up Vessel/Jack-up Accommodation Vessel	2	•	•	•	•	•
Transport Freighter	3			•		
Support Barge	1			•		
Boulder Clearance Vessel	2			•	•	
Sand Wave Leveling Vessel	2			•	•	
PLGR Vessel	2			•	•	
Cable Laying Vessel	3			•	•	
Cable Burial Vessel	2			•	•	
Cable Remedial Protection Vessel	2			•	•	
Array Walk-2-Work Vessel	1				•	
Survey Vessel	5			•	•	
CTV	5	•	•	•	•	•

CONSTRUCTION AND OPERATIONS PLAN

Description of Proposed Activity – Project Design and Construction Activities

Vessel Type	# of Vessels	Foundations	OCS DC	SRWEC	IAC	WTGs
Guard/Safety Vessel	5	•	•	•	•	•
SOV	1	•	•		•	•
Helicopter	1	•	•	•	•	•

3.3.10.2 Material Transport

Large Project components, including the WTGs, the foundations, OCS–DC topside, cables, and HDD cable duct may be transported to an existing port for pre-assembly or storage prior to being delivered to the SRWF and landfall location, or they may be delivered directly to the SRWF from offsite fabrication and manufacturing facilities located in North America, Europe, and/or Asia. Some large Project components, as well as secondary equipment, supplies and crew, will be transported to and from the SRWF from existing ports. Helicopters may be used for crew changes during installation of the WTGs.

Some equipment and materials required for the Landfall HDD and ICW HDD may be transported via barge from the Smith Point Marina to Smith Point County Park due to existing weight limit restrictions on the Smith Point Bridge. A temporary floating pier may be installed at Smith Point County Park to aid in the offloading of equipment/materials. The temporary floating pier would be up to approximately 1,500 sq ft (139 sq m) and would consist of a floating module and a ramp connecting the floating module to shore. The temporary floating pier will be secured to the seabed with up to 12 spuds, each of which will be approximately 5 sq ft [0.46 sq m]. The draft of the floating pier is anticipated to be approximately 1.5 to 3 ft. The temporary floating pier would likely be set up for a few weeks in the fall and a few weeks in the spring to bring over and remove equipment. Depending on the logistics planning, the temporary floating pier may need to remain in place from fall to spring. The temporary floating pier may be used during two construction periods since the Landfall HDD, ICW HDD, and SRWEC pull-in may be done in different years.

3.3.10.3 Chemical Transport

During construction, all chemicals will be brought to site aboard vessels and be transported in manufacturer's original packaging or in National Transportation Safety Council (NTSC) approved tote containers. It is anticipated that any chemicals to be stored on site will be integral with associated equipment and will not be transported independently from this equipment.

During construction, chemicals transfers may take place daily depending on operational requirements of the various contractors. Chemical transfers will be executed in accordance with industry best practices considering health, safety, and environment, and will be in compliance with local, state, and federal regulations. Chemical transfer volumes will be determined by operational requirements of the various contractors, and will be in compliance with all local, state, and federal regulations.

CONSTRUCTION AND OPERATIONS PLAN

Description of Proposed Activity – Project Design and Construction Activities

Any chemicals to be treated or disposed of will be transported to typical onshore waste receiving sites within the area that conform to safe and environmentally friendly methods in accordance with local, state, and federal regulations. Summaries of maximum quantities of anticipated chemicals are presented in Table 3.3.1-2 and Table 3.3.6-2. Sunrise Wind will also implement an ERP/OSRP (Appendix E1) and an SPCC, that will be developed as part of the EM&CP for the Project.

Sunrise Wind will meet applicable regulations and standards, as set by the International Maritime Organization's (IMO) International Convention for the Prevention of Pollution from Ships (MARPOL), the USCG, and the State of New York, for treatment and disposal of solid and liquid wastes generated during all phases of the Project. Solid and liquid waste volumes for the Project will be updated for the FDR/FIR.

Table 3.3.10-4 provides the amounts of solid and liquid wastes generated by vessel activity during the construction and disposal and treatment methods. All vessels will comply with USCG standards in US territorial waters to legally discharge uncontaminated ballast and bilge water, and standards regarding ballast water management. Outside of US territorial waters, vessels will be compliant with the IMO Ballast Water Management Convention standards.

Table 3.3.10-4 Anticipated Solid and Liquid Wastes Generated During Offshore Construction

Source	Construction cubic yd (m ³)	Method of Disposal
Oily bilge water	3,461 (2,646)	Stored onboard and delivered to a port reception facility or treated onboard with an oil water separator
Oily residues (sludge)	957 (732)	Stored onboard and delivered to a port reception facility
Sewage	4,112 (3,144)	Treated onboard with an IMO/USCG-certified Marine Sanitation Device and discharged overboard or delivered to a port reception facility
Plastics	2,467 (1,886)	Stored onboard and delivered to a port reception facility
Food wastes	411 (314)	Stored onboard and delivered to a port reception facility or discharged overboard in accordance with US regulations
Domestic wastes	411 (314)	Stored onboard and delivered to a port reception facility
Cooking oil	106 (81)	Stored onboard and delivered to a port reception facility
Operational wastes	1,908 (1,459)	Stored onboard and delivered to a port reception facility

Vessels will observe the 3.5-mi (3-nm) No-Discharge Zone and will be equipped with an IMO/USCG-certified Marine Sanitation Device for treatment of sewage if the vessel is to discharge treated effluent outside of the 3.5-mi (3-nm) No-Discharge Zone.

3.3.10.4 Temporary Construction Work Zone

The USCG routinely establishes temporary safety zones to facilitate mariner safety for a variety of waterway activities such as bridge construction, cable laying, wreck removal, etc.

CONSTRUCTION AND OPERATIONS PLAN

Description of Proposed Activity – Commissioning

Temporary safety zones were established during the construction of the Block Island Wind Farm, including inter-array and export cable installation activities ¹⁴.

Sunrise Wind will request, and it is expected the USCG will establish, temporary safety zones around each WTG, the OCS–DC, and each cable-laying vessel. Specifically, the following will be requested:

- The WTG and OCS–DC safety zones would extend to a maximum 500-yd (457-m) radius and would be enforceable only while construction vessels are on-scene and engaged in construction activity.
- For cable-laying vessels, moving safety zones of up to 500 yd (457 m) total centered on each vessel as it progresses along the cable route would be established.

Sunrise Wind will implement a communication plan (see Appendix B) during construction to inform mariners of construction activities, vessel movements, and how construction activities may affect the area. Communication will be facilitated through maintaining a Project website, the Fisheries Liaison, submitting local notices to mariners and vessel float plans, and coordinating with the USCG.

3.4 Commissioning

Commissioning of the Project involves testing of Project components to meet standards for safety and grid interconnection reliability. Certain activities to support commissioning of offshore Project components are completed onshore prior to transit offshore. Commissioning of offshore Project components will require technicians to travel to each WTG and the OCS–DC to perform certain activities; it is expected that technicians will travel via CTVs, SOV, and/or helicopters. Commissioning of the various Project components is included in the construction durations summarized in Section 3.2.

3.4.1 Onshore Converter Station

Commissioning of the OnCS–DC will include Site Acceptance Testing and Site Integration Testing. To verify the high-voltage system of the OnCS–DC, the system will be energized using an external energy source and tested to confirm that all high-voltage apparatus, switching philosophy, interlocking, and metering apparatus associated with high-voltage equipment operate as per the design. Each system on the OnCS–DC will be integrated, displayed, and controlled using a SCADA Control System. At this point, the OnCS–DC auxiliary equipment will be operational and ready for energization.

¹⁴ As described in 81 Federal Register 31862. <https://www.federalregister.gov/documents/2016/05/20/2016-11826/safety-zone-block-island-wind-farm-rhode-island-sound-ri>.

CONSTRUCTION AND OPERATIONS PLAN

Description of Proposed Activity – Operations and Maintenance

3.4.2 Offshore Converter Station

The commissioning of the OCS–DC will be at a high level of completion and will be verified prior to offshore transport to the Project Area. The onshore commissioning campaign will include Site Acceptance Testing and Site Integration Testing. The OCS–DC will be energized using an external energy source and tested to confirm that all high-voltage apparatus, switching philosophy, and interlocking associated with high-voltage equipment operate as per the design.

Once installed offshore, commissioning includes initial start-up of the OCS–DC and a final Offshore Site Acceptance Test of each individual system. Each system on the OCS–DC will be integrated, displayed, and controlled using a SCADA Control System. At this point, the OCS–DC auxiliary equipment will be operational and ready for energization. If it is not possible to energize directly after installation (e.g., due to lack of grid, defective component, or vessel requirements, and/or to allow the vessel to meet certain weather windows), then the use of diesel generators may be required to commence with initial commissioning activities.

Once the OCS–DC is commissioned, it is ready to be connected to the grid network via the SRWEC. This step is normally initiated immediately following the installation of the offshore platform.

3.4.3 Wind Turbine Generators

A number of quality control and WTG commissioning activities will be completed onshore prior to transporting WTGs to the SRWF. Upon successful completion of WTG installation and energization, offshore commissioning works will begin. If it is not possible to energize directly after installation (e.g., due to lack of grid, defective component or vessel requirements, and/or to allow the vessel to meet certain weather windows), then the turbine may be powered by either a permanent integrated battery back-up power solution or by use of temporary diesel generators to keep the WTG in a safe and dry condition (by operating the dehumidifiers in tower and nacelle) and to commence with initial commissioning activities. Final commissioning includes several system functionality and verification tests.

3.5 Operations and Maintenance

Per the Lease, the operations term of the Project is 25 years but could be extended to 30 or 35 years. The operations term will commence on the date of COP approval. It is anticipated that Sunrise Wind will request to extend the operations term in accordance with applicable regulations in 30 CFR § 585.235.

The O&M Plan for both the Project's onshore and offshore infrastructure will be finalized as a component of the FDR/FIR review process; however, a preliminary O&M plan for the Onshore Facilities, offshore transmission facilities (e.g., the SRWEC, IAC, and the OCS–DC electrical components) and WTGs is provided in the following sections. As noted previously, various existing ports are under consideration to support offshore construction, assembly and fabrication, crew transfer and logistics (including for O&M activities) (see Section 3.3.9.4 and Table 3.3.10-3).

The Project will rely on Ørsted's more than two decades of operational experience across more than 26 offshore wind farms currently in operation, as well as Eversource's decades of experience operating transmission assets across New England. To support O&M, the Project will be controlled 24/7 via a remote surveillance system (i.e., SCADA).

CONSTRUCTION AND OPERATIONS PLAN

Description of Proposed Activity – Operations and Maintenance

Sunrise Wind is currently investigating locations and facilities across New York, New England, and the Mid-Atlantic to provide O&M support to the Project. It is anticipated that any O&M facility that is used to support the Project will also support other offshore wind projects on the US East Coast, and potentially also other maritime industries. Sunrise Wind has not made a final decision on which O&M facility (or facilities) to use, and is currently considering the following existing ports:

- Brooklyn, New York;
- Montauk, New York;
- Port Jefferson, New York;
- Port of Galilee, Rhode Island; and
- Quonset, Rhode Island.

The decision on the location of the O&M offices, warehouse, main component storage facilities, port call, and airfield (if required) will depend on several factors, including but not limited to: supply chain footprint, portfolio synergies, geographical proximity to the Project, the presence of existing infrastructure, and workforce opportunities. It is most efficient for the offshore wind industry, to the extent practicable, to leverage existing facilities and infrastructure that are suitable, hence limiting the need for upgrades or modifications. Additional information regarding the O&M facilities is provided in Section 3.5.5.

3.5.1 Onshore Facilities

Sunrise Wind will monitor the OnCS–DC remotely on a continuous basis. The equipment in the OnCS–DC will be configured with a condition monitoring system that will sound an alarm upon detecting equipment faults, unintended shutdowns, or other issues. In addition, the OnCS–DC will be inspected for anomalies with the equipment operation in accordance with manufacturers' recommendations. Sunrise Wind will put in place an established and documented program for the maintenance of all equipment critical to reliable operation. Maintenance programs will conform to the equipment manufacturer's recommendations.

In addition, a reliability maintenance program will be implemented. Preventive maintenance will be performed on the OnCS–DC, Onshore Transmission Cable, and Onshore Interconnection Cable, and planned outages will be conducted in accordance with the North American Electric Reliability Corporation (NERC)/Northeast Power Coordinating Council, Inc. (NPCC) Standard-TOP-003-1, and protective system maintenance will be performed in accordance with the NPCC PRC 005-2 standard. Equipment will be maintained in accordance with the interconnection agreement; maintenance will be completed by qualified personnel in accordance with applicable industry standards and good utility practice to provide maximum operating performance and reliability.

Vegetation will be managed to ensure safe operation of and access to the Onshore Transmission Cable and Onshore Interconnection Cable, as needed. To support O&M of the onshore section of the SRWEC and portions of the Onshore Transmission Cable, a 20-ft (6-m)-wide Project Easement for Operational ROW centered on the cables will be requested. Sunrise Wind does not intend to use pesticides during operation of the Project. While the vegetation management requirements for the Project are expected to be minimal, the use of herbicides to

CONSTRUCTION AND OPERATIONS PLAN

Description of Proposed Activity – Operations and Maintenance

effectively manage the vegetation for reliability purposes would be considered as part of an effective Integrated Vegetation Management (IVM) program. IVM practices include manual cutting, mowing and the prescriptive use of federally-approved and state-registered herbicides to eliminate targeted plant species within the ROW. Herbicides are an integral part of the IVM program and would be applied, using federally-approved, NYS-listed herbicides, following all NYS and local regulations and label restrictions. More specific details on the IVM program would be provided within the Project EM&CP.

3.5.2 Offshore Transmission Facilities

Pursuant to 30 CFR § 585.200(b), Sunrise Wind has the right to one or more easements, without further competition, as necessary for the full utilization of the lease, and under applicable regulations in 30 CFR § 585. Sunrise Wind is requesting a project easement up to 200 ft wide (61 m wide) centered on the export cable. It is expected that O&M activities for the export cable, particularly should a fault or failure occur, could require additional area outside the surveyed corridor to support a repair. Prior to repair works, surveys would be undertaken for areas anticipated to be impacted by a repair. Additional licenses and/or easements required for the SRWEC–NYS are discussed in Section 1.4.3.

A summary of offshore transmission facility routine maintenance activities and the anticipated frequency at which they may occur is provided in Table 3.5.2-1. Routine maintenance requirements (including frequencies) referenced in this table are used to support analyses in this COP and are subject to change based on final design specifications and manufacturer requirements. Detailed information regarding maintenance and required frequencies will be included in the FDR/FIR, to be reviewed by the CVA and submitted to BOEM prior to construction.

Table 3.5.2-1 Routine Maintenance Activities for Offshore Transmission Assets

Maintenance/Survey Activity	Indicative Frequency
Routine service of electrical components	20 per year
Electrical inspections of the OCS–DC	2 per year
Scheduled maintenance of OCS–DC components	Annual
Seafloor survey (i.e., bathymetry, cable burial depth, cable protection)	At 1 year after commissioning, 2-3 years after commissioning, and 5-8 years after commissioning; frequency thereafter will depend on the findings of the initial surveys
Minor corrective and preventative maintenance of OCS–DC equipment	7 per year
Major corrective and preventative maintenance of OCS–DC equipment	2 per lifetime

Sunrise Wind will employ a proprietary state-of-the-art asset management system to inspect offshore transmission assets including the OCS–DC (electrical components), SRWEC, and IAC. This system provides a data-driven assessment of the asset condition and allows for prediction and assessment of whether inspections and/or maintenance activities should be accelerated or postponed. This approach allows the Project to maximize O&M efficiencies.

CONSTRUCTION AND OPERATIONS PLAN

Description of Proposed Activity – Operations and Maintenance

The SRWEC and IAC typically have no maintenance requirements unless a fault or failure occurs. To evaluate integrity of the assets, Sunrise Wind intends to conduct a bathymetry survey along the entirety of the cable routes immediately following installation (scope of installation contractor), and at 1 year after commissioning, 2–3 years after commissioning, and 5–8 years after commissioning. Survey frequency thereafter will depend on the findings of the initial surveys (i.e., site seabed dynamics and soil conditions). A survey may also be conducted after a major storm event (i.e., greater than 10-year event). Surveys of the cables may be conducted in coordination with scour surveys at the foundations.

Should the periodic bathymetry surveys completed during the operational lifetime of the Project indicate that the cables no longer meet an acceptable burial depth (as determined by the Cable Burial Risk Assessment), the following actions may be taken:

- Alert the necessary regulatory authorities, as appropriate;
- Undertake an updated Cable Burial Risk Assessment to establish whether cable is at risk from external threats (i.e., anchors, fishing, dredging);
- Survey monitoring campaign for the specific zone around the shallow buried cable; and
- Assess the risk to cable integrity.

Based on the outcome of these assessments, several options may be undertaken, as feasible, permitted and practical:

- Remedial burial if feasible and practical;
- Secondary protection (rock protection, rock bags or mattresses); and/or
- Increased frequency of bathymetry surveys to assess reburial.

It is possible submarine cables may need to be repaired or replaced due to fault or failure. Also, it is expected that a maximum of 10 percent of the cable protection placed during installation may require replacement/remediation over the lifetime of the Project.

These maintenance activities are considered non-routine. If cable repair/replacement or remedial cable protection are required, the Project will complete any necessary surveys of the seafloor in areas where O&M activities would occur and obtain necessary approvals. These activities will result in a short-term disturbance of the seafloor similar to or less than what is anticipated during construction.

3.5.3 Wind Turbine Generator and Offshore Converter Station Foundations

A summary of WTG and OCS–DC foundation maintenance activities and the anticipated frequency at which they may occur is provided in Table 3.5.3-1. Maintenance requirements (including frequencies) referenced in this table are used to support analyses in this COP and are subject to change based on final design specifications and manufacturer requirements. Detailed information regarding maintenance and required frequencies will be included in the FDR/FIR, to be reviewed by the CVA and submitted to BOEM prior to construction.

CONSTRUCTION AND OPERATIONS PLAN

Description of Proposed Activity – Operations and Maintenance

Table 3.5.3-1 Foundation Maintenance Activities

Maintenance/Survey Activity	Indicative Frequency
Above water inspection and maintenance <i>Visual inspections for deterioration of coating system, inspection of corrosion, damage within the splash zone, reading of meters, inspection of alarm logs, etc.</i>	Annual
Subsea inspection <i>To detect, measure, and record deterioration that affects structural integrity, including inspection of corrosion, minor maintenance activities that can be performed without outage/reduced power production (yield)</i>	3 to 5 years or defined based on risk
Major maintenance	Every 8 years
Corrective Maintenance <i>Coating repair, inspection of corrosion and maintenance, maintenance activities that can be performed without outage/reduced power production (yield)</i>	As needed
Seafloor Survey <i>Bathymetry, scour, etc.</i>	At 1 year after commissioning, 2-3 years after commissioning, and 5-8 years after commissioning; frequency thereafter will depend on the findings of the initial surveys

3.5.4 Wind Turbine Generators

A summary of WTG maintenance activities and the anticipated frequency at which they may occur is provided in Table 3.5.4-1. Maintenance requirements (including frequencies) referenced in this table are used to support analyses in this COP and are subject to change based on final design specifications and manufacturer requirements. Detailed information regarding maintenance and required frequencies will be included in the FDR/FIR, to be reviewed by the CVA and submitted to BOEM prior to construction. As discussed in Section 3.3.1, WTGs will be continuously remotely monitored via the SCADA systems from shore.

Table 3.5.4-1 WTG Maintenance Frequency

Maintenance/Survey Activity	Indicative Frequency
Routine Service & Safety Surveys/Checks	Annual
Oil and High-Voltage Maintenance	Annual
Visual Blade Inspections (Internal and External)	Annual
Fault Rectification	As needed
Major Replacements	As needed
End of Warranty Inspections	At end of warranty period

Preventative maintenance activities will be planned for periods of low wind and good weather (typically corresponding to the spring and summer seasons). The WTGs will remain operational between work periods of the maintenance crews.

CONSTRUCTION AND OPERATIONS PLAN

Description of Proposed Activity – Operations and Maintenance

Certain O&M activities may require presence of either a jack-up vessel or anchored barge vessel. These activities will result in a short-term disturbance of the seafloor similar to or less than what is anticipated.

3.5.5 Ports, Vessels and Vehicle Mobilization and Material Transportation

Sunrise Wind expects to use a variety of vessels to support O&M, including SOVs with deployable work boats (SOV support craft), CTVs, jack-up vessels, and cable laying vessels. A hoist-equipped helicopter and unmanned aircraft systems may also be used to support O&M. Table 3.5.5-1 provides a summary of O&M support vessels that are currently being considered to support Project O&M. The type and number of vessels and helicopters will vary over the operational lifetime of the Project. For each vessel type the route plan for the vessel operation area will be developed to meet industry guidelines and best practices in accordance with International Chamber of Shipping guidelines. The Project will install operational AIS on all vessels associated with the operation of the Project. AIS will be used to monitor the number of vessels and traffic patterns for analysis and compliance with vessel speed requirements. All vessels will operate in accordance with applicable rules and regulations for maritime operation within US and federal waters. Similarly, all aviation operation, including flying routes and altitude, will be aligned with relevant stakeholders (e.g., the FAA). Additionally, the Project will adhere to vessel speed restrictions as appropriate.

The Project is evaluating the use of several port options to support O&M of the Project (see Table 3.3.10-1). O&M facilities at/near some or all of these ports will be used for windfarm monitoring and equipment storage for multiple offshore wind projects, including the Sunrise Wind Farm, Revolution Wind Farm, and South Fork Wind Farm—not to mention, in one case, being used for general corporate purposes. Furthermore, to the extent that these potential O&M facilities would require any upgrades, their potential impacts to historic or cultural properties are being considered in the COP review processes for other projects, or by other agencies. (There are no plans to establish an O&M building at, or otherwise implement improvements to, the Port of Galilee or Port of Brooklyn; instead, use of these ports would be limited to existing facilities that are maintained by the port, and will not require upgrades).

- **Port Jefferson, Research Way O&M Building:** The Research Way facility is described and evaluated in the Revolution Wind Farm COP (Revolution Wind, LLC 2021). It is an existing upland building currently planned to serve as a regional O&M hub and headquarters for Orsted and multiple offshore wind projects. The building is located approximately 6 mi (9.7 km) from Port Jefferson harbor at 22 Research Way in Setauket-East Setauket, NY, within an office park that also hosts technology companies and healthcare providers (among other businesses). A review of publicly available records and historic aerial photography indicated that this building was constructed between 1985 and 1992. It has no record within the NYSHPO and does not appear to satisfy the criteria of NRHP eligibility. The building was recently purchased by Northeast Offshore, LLC, and internal upgrades to establish office and warehouse space are planned.

CONSTRUCTION AND OPERATIONS PLAN

Description of Proposed Activity – Operations and Maintenance

The contemplated work requires no governmental authorization other than local building permits, and will consist almost entirely of interior renovations to create workspaces. No external expansions or modifications are planned; instead, any work affect the exterior of the building will be limited to repairs (e.g., broken windows), and will preserve the existing appearance. The only other exterior work being contemplated consists of maintenance of the parking lot and landscaping (which will be limited to the existing design and scope of use), and the potential addition of signage. As a result, there will be no work that could directly or indirectly cause alterations in the character or use of historic properties.

The Research Way facility will not be just an O&M facility for a particular project, but rather will be capable of serving multiple projects, as well as general Orsted and Eversource business needs. It therefore will have utility independent of the Project. The building will be a base for technical, commercial (e.g., contract managers), and warehouse employees, as will also serve as the management headquarters for Orsted's North American operations team. In addition, marine coordination activities for all North East Offshore projects will be conducted from the building.

- **Port Jefferson, O&M Harbor:** Upgrades to the Port Jefferson O&M harbor facility will be permitted by the USACE, including through Section 106 consultation. Orsted and Eversource are currently evaluating multiple different locations in Port Jefferson Harbor to berth an SOV which will service multiple offshore wind projects. Several scenarios are under evaluation, including using an existing pier at the Port Jefferson Power Station, as well as constructing a new pier adjacent to 146 Beach Street in Port Jefferson, NY. Dredging may be required at either scenario. As the SOV will only return to shore once or twice per month for one day, the facility would be able to be utilized by other users. The facility will not be for a particular project, but rather will be capable of serving multiple projects, as well as other users. It therefore will have utility independent of the Project.

No new upland structures are planned for either scenario at the harbor. Only container storage may be established on an interim basis when the SOV comes to shore. This work would be completed in advance of, and is not dependent upon, approval of the Project. Again, all of this activity will be permitted by the USACE, including through Section 106 consultation.

- **Port of Brooklyn:** The existing South Brooklyn Marine Terminal facility may also be utilized as berth for an SOV. No new activity is planned onshore or in-water in order to berth an SOV here.
- **Port of Davisville-Quonset Point:** As described and evaluated in the South Fork Wind Farm COP (South Fork Wind, LLC 2021), a new building with office space and equipment storage space, as well as aviation support facilities, is planned to be constructed at the Port of Davisville-Quonset Point. The facility may also include a stationary crane for equipment transfer and up to five vessel berths for CTVs. Analysis of this facility is included in the ongoing review of the South Fork Wind Farm Project.
- **Port of Galilee:** The existing facility may be utilized as berths for CTVs. No new activity is planned onshore or in-water in order to berth CTVs here.

CONSTRUCTION AND OPERATIONS PLAN

Description of Proposed Activity – Operations and Maintenance

- Port of Montauk:** As described and evaluated in the South Fork Wind Farm COP (South Fork Wind, LLC 2021), a new building with office space and equipment storage space will be constructed at the Port of Montauk. The facility will also include a stationary crane for equipment transfer and up to three vessel berths for CTVs. Modifications may also include reinforcement and/or rehabilitation of quayside(s), as well as both initial and maintenance dredging to support the CTVs. Analysis of this facility is included in BOEM's ongoing review of the South Fork Wind Farm Project.

During O&M, helicopters may be used to provide supplemental means of access when vessel access is not practical or desirable. Flights may be restricted to daylight operations when visibility is good. Helicopters and unmanned aircraft systems may be used to support O&M:

- Helicopter Hoist Operations.** An integrated helicopter hoist platform located on the roof of each WTG nacelle will provide access for O&M. SOVs and the OCS-DC may also be fitted with helicopter hoist platforms. The purpose of this effort is primarily for transport/transfer of technical personnel and equipment on to/from the WTGs via hoist to the nacelle, but can also be conducted for transport/transfer of personnel and equipment to offshore installations that do not have a helideck. This is the means of access in the O&M phase and is typically used to perform minor repairs and restarts. Hoist operations can be combined with transport helicopter operation, e.g., landing on a vessel with a helideck and hoisting technicians or goods afterwards to a WTG.
- Transport/Transfer Operations.** Transport helicopter operations are flights from an onshore airport/heliport to an offshore installation or vessel with a helideck and back. Transfer helicopter operations are flights within the SRWF, from an offshore installation or vessel with a helideck to another, and back.
- Unmanned Aircraft Systems.** Unmanned aircraft systems may be used for inspection of blades, structures, seabed inspections, and cargo delivery between the assets in the wind farm.

Table 3.5.5-1 Summary of O&M Vessels and Helicopters

Activity Type	Vessel Type	Foundations	OCS DC	SRWEC	IAC	WTGs
Routine (e.g., annual maintenance, troubleshooting, inspections)	Service Operations Vessel (SOV)	•	•	•	•	•
	Support Craft	•	•	•	•	•
	CTV/Surface Effects Ship	•	•	•	•	•
	Helicopter		•			•
	Unmanned Aircraft System	•	•			•
Non-Routine (e.g., major components exchange)	Jack-Up Vessel		•			•
	Cable-Lay/Cable Burial Vessel			•	•	
	Support Barge		•	•	•	•

CONSTRUCTION AND OPERATIONS PLAN

Description of Proposed Activity – Operations and Maintenance

3.5.6 Chemical and Waste Management

During operations, all chemicals will be initial fills and will be handled on site in original manufacturers packaging or in NTSC tote containers. With exception of diesel fuel and engine lubricants, all chemicals normally remain on site for the life of the Project. Because any anticipated chemicals to be stored on site will be integral to equipment packages, it is anticipated that chemical transfers will only take place in the form of equipment installation and/or replacement, which will take place only as required throughout the life of the installation. The quantities expected to be transferred are considered minimal. If disposal is required, transfer and transportation would be carried out by a licensed transporter.

Any chemicals to be treated or disposed of will be transported to typical onshore waste receiving sites within the area that conform to safe and environmentally friendly methods in accordance with local, state, and federal regulations. Summaries of maximum quantities of anticipated chemicals are presented in Table 3.3.1-2 and Table 3.3.6-2. Sunrise Wind will also implement an ERP/OSRP (Appendix E1).

Sunrise Wind will meet applicable regulations and standards, as set by the IMO MARPOL, the USCG, and the State of New York, for treatment and disposal of solid and liquid wastes generated during all phases of the Project. Solid and liquid waste volumes for the Project will be updated for the FDR/FIR.

Table 3.5.6-1 provides the anticipated amounts of solid and liquid wastes generated by vessel activity during one year of operation, and disposal and treatment methods. Solid and liquid waste amounts will be updated for the FDR/FIR. All vessels will comply with USCG standards in US territorial waters to legally discharge uncontaminated ballast and bilge water, and standards regarding ballast water management. Outside of US territorial waters, vessels will be compliant with the IMO Ballast Water Management Convention standards.

Table 3.5.6-1 Anticipated Solid and Liquid Wastes Generated During One Year of Offshore Operations

Source	One Year of Operation cubic yd (m ³)	Method of Disposal
Oily bilge water	216 (165)	Stored onboard and delivered to a port reception facility or treated onboard with an oil water separator
Oily residues (sludge)	67 (51)	Stored onboard and delivered to a port reception facility
Sewage	349 (267)	Treated onboard with an IMO/USCG-certified Marine Sanitation Device and discharged overboard or delivered to a port reception facility
Plastics	209 (160)	Stored onboard and delivered to a port reception facility
Food wastes	35 (27)	Stored onboard and delivered to a port reception facility or discharged overboard in accordance with US regulations
Domestic wastes	35 (27)	Stored onboard and delivered to a port reception facility
Cooking oil	5 (4)	Stored onboard and delivered to a port reception facility
Operational wastes	140 (107)	Stored onboard and delivered to a port reception facility

CONSTRUCTION AND OPERATIONS PLAN

Description of Proposed Activity – Decommissioning

Vessels will observe the 3.5-mi (3-nm) No-Discharge Zone and will be equipped with a USCG-certified Marine Sanitation Device for treatment of sewage if the vessel is to discharge treated effluent outside of the 3.5-mi (3-nm) No-Discharge Zone.

3.5.7 Lighting and Marking of Offshore Project Components

Navigation lights, markings, sound signals, and other aids-to-navigation, including AIS on select WTGs, will be installed and maintained as prescribed within the PATON permit issued by the USCG for each WTG and the OCS–DC, (a total of up to 123 individual PATON permits). Additionally, PATONS will be obtained for the lidar, wave buoy, and ADCP, as necessary.

A notional aids-to-navigation (ATON) lighting plan is included in Appendix X – *Navigation Safety Risk Assessment* (NSRA). The notional ATON lighting plan is based on existing USCG regulations and policy, and standards promulgated by the IALA in Recommendation O-139, *The Marking of Man-Made Offshore Structures* (IALA 2013). The USCG has endorsed those standards. A final aids-to-navigation plan will be prepared in consultation with the USCG and will include the latest USCG guidance pursuant to issuance of USCG PATON permits.

Additionally, Sunrise Wind will also light and mark all WTGs in accordance with FAA Advisory Circular 70/7460-1L (2018), as recommended by BOEM's *Guidelines for Lighting and Marking of Structures Supporting Renewable Energy Development* (BOEM 2021). As currently recommended, the lights would consist of two L-864 medium intensity red lights mounted on the nacelle and up to three L-810 low intensity red lights mounted on the midsection of the WTG tower, and all lights will have a synchronous flash rate of 30 flashes per minute (FPM).” The OCS–DC will also be lit and marked in accordance with BOEM, FAA, and USCG requirements for aviation and navigation obstruction lighting, respectively.

The Project is evaluating the implementation of methods to limit the visual impact of the aviation light, for example, the use of an ADLS to turn on, and off, the aviation obstruction lights in response to detection of aircraft in proximity to the SRWF. Sunrise Wind will use an ADLS, or related means (e.g., dimming or shielding) to limit visual impact, pursuant to approval by the FAA and BOEM and commercial and technical feasibility at the time of FDR/FIR approval. Results of a Project-specific ADLS study are provided in Appendix Y2 – *Air Traffic Flow Analysis/ADLS Analysis*.

3.6 Decommissioning

At the end of the Project's operational life, it will be decommissioned in accordance with a detailed Project decommissioning plan that will be developed in compliance with applicable laws, regulations, and BMPs at that time. All facilities will need to be removed to a depth of 15 ft (4.6 m) below the mudline, unless otherwise authorized by BOEM (30 CFR § 585.910(a)). Care will be taken to handle waste in a hierarchy that prefers re-use or recycling, and leaves waste disposal as the last option. Absent permission from BOEM, Sunrise Wind will complete decommissioning within two years of termination of the Lease.

Sunrise Wind will develop a final decommissioning and removal plan for the facility that complies with all relevant permitting requirements. This plan will account for changing circumstances during the operational phase of the Project and will reflect new discoveries particularly in the areas of marine environment, technological change, and any relevant amended legislation.

SECTION 4 – SITE CHARACTERIZATION AND ASSESSMENT OF IMPACTS

4.1 Characterization and Assessment Approach

The site characterization and assessment of potential impacts for the Project is structured in accordance with 30 CFR 585 and the BOEM *Information Guidelines for a Renewable Energy Construction and Operations Plan (COP)* (BOEM 2020), as required by 30 CFR 585.626(a) and (b). The characterization and assessment approach also considers the additional detailed information and certifications, as specified under 30 CFR 585.627, which support BOEM's compliance with NEPA regulations and other applicable laws and regulations.

The approach to site characterization and impact assessment involves the following steps, which are further illustrated in Figure 4.1-1.

- **Identification and Analysis of Impact Producing Factors:** Project activities and infrastructure, as described in Section 3.0, that could affect resources are identified as Impact Producing Factors (IPF). An IPF could directly or indirectly affect physical, biological, visual, cultural, socioeconomic, and transportation and navigation resources. Where Project specifications are not available because final design has not been completed, the PDE was considered to include the range of possible impact-producing activities. Section 4.2 describes each IPF and Table 4.2-1 presents a matrix of IPFs by anticipated Project activity and phase.
- **Characterization of Affected Environment:** The environmental setting of the Project, including the footprint within federal waters, NYS waters, and onshore within the Town of Brookhaven, New York, is described for physical, biological, visual, cultural, socioeconomic, and transportation and navigation resources that have the potential to be affected by Project activities. The affected environment includes a regional overview of the resource followed by characterization of the resource relative to the Project Area, described separately for the SRWF, SRWEC–OCS, SRWEC–NYS, and Onshore Facilities; refer to Section 3.0 for the description of the Project structures included in each of these categories.
- **Impact Assessment:** The impact assessment for the Project involves the evaluation of potential overlap of each IPF, in time and space, on the affected environment for each resource, during construction and O&M, as shown in Table 4.2-2. The approach for evaluating potential impacts during decommissioning of the Project is described below. The type and degree of potential impacts from proposed Project activities vary based on the characteristics of the resource (e.g., presence/absence, conservation status, abundance) and the IPF that may affect each resource. Similar to the description of the affected environment, potential impacts are discussed separately for the SRWF, SRWEC–OCS, SRWEC–NYS, and Onshore Facilities, as appropriate.

CONSTRUCTION AND OPERATIONS PLAN

Site Characterization and Assessment of Impacts – Characterization and Assessment Approach

Potential impacts are characterized as direct or indirect—direct impacts are those occurring at the same place and time as the initial cause or action and indirect impacts are those that occur later in time or are spatially removed from the activity. The anticipated duration of an impact and recovery time following the impact are also described, often qualitatively and in connection to the Project phase. For example, an impact may be described as temporary, and limited to a particular construction activity, with rapid recovery following the cessation of the activity. Alternatively, an impact may be described as existing for the duration of a particular phase, or over the entire life of the Project (i.e., 25 to 35 years).

The assessment evaluates the degree to which an affected resource is expected to be adversely impacted, as well as its ability to recover. For each resource, if measures are proposed to avoid or minimize potential impacts, the impact evaluation includes consideration of these environmental protection measures. These are further summarized for each resource at the end of its impact assessment.

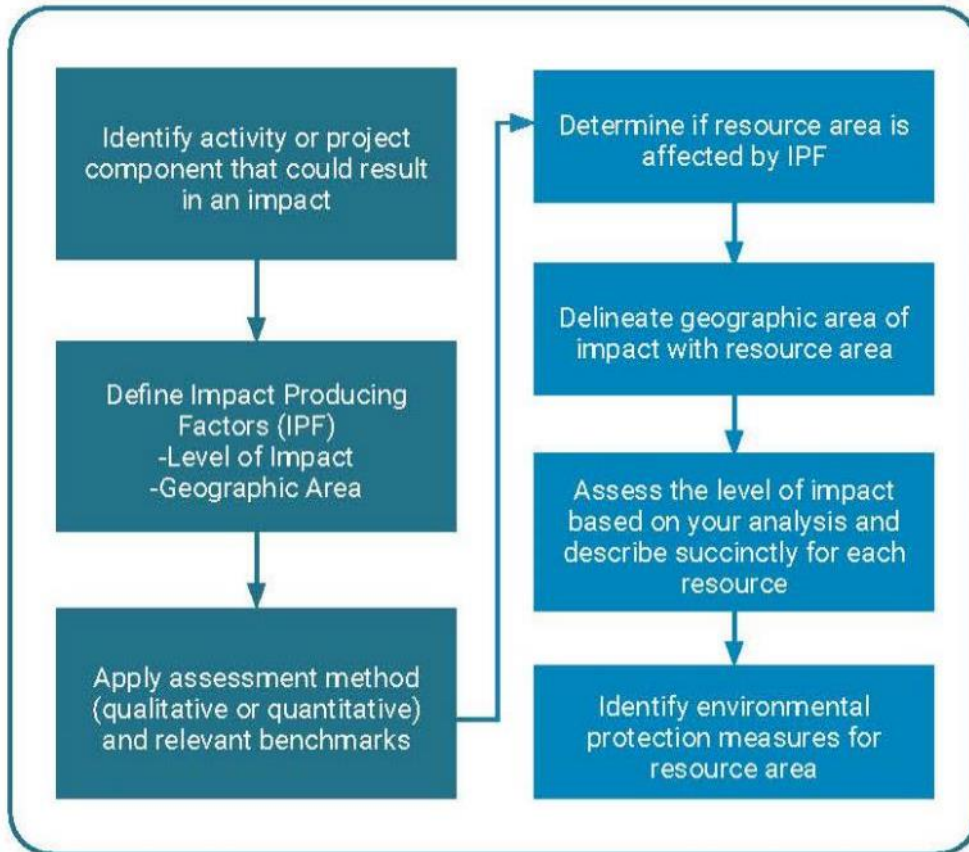

Figure 4.1-1 Illustration of Steps Involved in the Proposed Impact Assessment

CONSTRUCTION AND OPERATIONS PLAN

Site Characterization and Assessment of Impacts – Impact Producing Factors

As described in Section 3.6, at the end of the Project's operational life, it will be decommissioned in accordance with a detailed Project decommissioning plan that will be developed in compliance with applicable laws, regulations, and BMPs at that time. During the decommissioning phase of the Project, most activities are anticipated to be similar to, or of lesser intensity than, those described for construction; therefore, impacts on resources from decommissioning are also anticipated to be similar to or less than those assessed below for construction. As such, and in recognition of the future development of a detailed Project decommissioning plan, decommissioning activities are not addressed separately within the individual resource impact assessments. The single exception to this approach is for benthic and shellfish resources, for which the Project is expected to result in *beneficial* impacts, which would then be reversed at the time of decommissioning. This reversal of beneficial Project impacts at the time of decommissioning is discussed in Sections 4.2.1.1, 4.4.2.2, and 4.4.3.2.

4.2 Impact Producing Factors

Applicable IPFs were identified for the Project based on the planned construction and O&M activities, as described in Section 3.0, and are listed below. In this section, each IPF is characterized in accordance with the scope of the Project phase and activity.

- Seafloor and Land Disturbance
- Sediment Suspension and Deposition
- Noise
- Electric and Magnetic Fields (EMF)
- Discharges and Releases
- Trash and Debris
- Traffic
- Air Emissions
- Visible Infrastructure
- Lighting and Marking

A summary of IPFs resulting from Project activities by phase is displayed as a matrix in Table 4.2-1. Table 4.2-2 identifies which IPFs may impact which resources and where in this COP the IPFs are specifically evaluated relative to resource topic areas.

This page intentionally left blank

CONSTRUCTION AND OPERATIONS PLAN

Site Characterization and Assessment of Impacts – Impact Producing Factors

Table 4.2-1 Anticipated Project Activities and Possible Impact-Producing Factors during Construction, Operations & Maintenance, and Decommissioning of the Project^{1a}

	Seafloor and Land Disturbance	Sediment Suspension and Deposition	Noise	EMF	Discharges and Releases	Trash and Debris	Traffic (Vessels, Vehicles, Air)	Air Emissions	Visible Infrastructure	Lighting and Marking
Construction										
Foundations/WTG/OCS-DC										
Marine Vessel and Heavy Equipment Use	•	•	•		•	•	•	•	•	•
Seafloor Preparation	•	•	•							
Foundation Installation/Placement of Scour Protection/Vessel Anchoring	•	•	•						•	•
IAC/SRWE C										
Marine Vessel Use	•	•	•		•	•	•	•	•	•
Seafloor Preparation	•	•	•							
Cable Installation/Placement of Cable Protection/Vessel Anchoring	•	•	•							
Landfall Work Area/ICW Work Area										
Marine Vessel and Heavy Equipment/Construction Vehicle Use	•	•	•		•	•	•	•	•	•
HDD/TJB Installation	•	•	•		•	•				•
Onshore Transmission Cable/Onshore Interconnection Cable										
Site Preparation	•	•	•		•			•		•
Heavy Equipment/Construction Vehicle Use	•	•	•				•	•		•
OnCS-DC										
Site Preparation	•	•	•		•			•		•
OnCS-DC Installation	•	•	•		•	•		•	•	•
Heavy Equipment/Construction Vehicle Use	•	•	•		•		•	•		•
Operations and Maintenance										
Material and Personnel Transportation										
Marine Vessel Use	•	•	•		•	•	•	•		•
Helicopter Use			•				•	•		
Vehicle Use			•				•	•		
WTG/OCS-DC/Operation and Maintenance	•	•	•	•	•				•	•
IAC/SRWE C Operation and Maintenance	•	•		•						
Onshore Transmission Cable Operation and Maintenance				•						
OnCS-DC Operation and Maintenance	•		•	•	•			•	•	•

CONSTRUCTION AND OPERATIONS PLAN

Site Characterization and Assessment of Impacts – Impact Producing Factors

	Seafloor and Land Disturbance	Sediment Suspension and Deposition	Noise	EMF	Discharges and Releases	Trash and Debris	Traffic (Vessels, Vehicles, Air)	Air Emissions	Visible Infrastructure	Lighting and Marking
Decommissioning										
Marine Vessel Use	•	•	•		•	•	•	•		•
Foundation Removal	•	•	•		•					
WTG Disassembly			•							
SRWEC Removal	•	•	•		•					
Onshore Transmission Cable (Removal or abandonment)	•		•							
OnCS-DC (repurposing or demolition)	•	•	•			•			•	•
a/ Refer to Section 3.0 for additional Project activity details.										

CONSTRUCTION AND OPERATIONS PLAN

Site Characterization and Assessment of Impacts – Impact Producing Factors

Table 4.2-2 Summary of the Evaluation of Impact-producing Factors Associated with the Project and Affected Physical, Biological, Visual, Cultural, Socioeconomic, and Transportation and Navigation Resources

Impact producing Factor	Physical Resources				Biological Resources							Visual Resources	Cultural Resources			Socioeconomic Resources						Transportation and Navigation		
	Oceanographic and Meteorological Conditions	Geological Conditions	Water Quality	Air Quality	Coastal and Terrestrial Habitat	Benthic and Shellfish Resources	Finfish and Essential Fish Habitat	Marine Mammals	Sea Turtles	Avian Species	Bat Species	Visual Resources	Marine Archaeological Resources	Terrestrial Archaeological Resources	Above ground Historic Properties	Employment, Economics, and Demographics	Public Services	Recreation and Tourism	Commercial and Recreational Fisheries	Other Marine Uses and Coastal Land Use	Environmental Justice	Marine Transportation and Navigation	Land Transportation and Navigation	Air Transportation and Navigation
Assessment Section Number	4.3.1	4.3.2	4.3.3	4.3.4	4.4.1	4.4.2	4.4.3	4.4.4	4.4.5	4.4.6	4.4.7	4.5.1	4.6.1	4.6.2	4.6.3	4.7.1	4.7.2	4.7.3	4.7.4	4.7.5	4.7.6	4.8.1	4.8.2	4.8.3
Seafloor and Land Disturbance		•			•	•	•	•	•	•	•		•	•					•	•	•			
Sediment Suspension and Deposition		•	•		•	•	•	•	•	•			•						•					
Noise						•	•	•	•	•	•				•				•		•			
Electric and Magnetic Fields						•	•	•	•										•					
Discharges and Releases			•		•	•	•	•	•	•									•					
Trash and Debris			•		•	•	•	•	•	•									•					
Traffic (Vessels, Vehicles, Air)							•	•	•	•	•	•			•		•	•	•		•	•	•	•
Air Emissions				•																				
Visible Infrastructure	•							•	•	•	•	•			•	•		•	•	•	•			•
Lighting and Marking							•	•	•	•	•	•			•			•	•		•	•		•

This page intentionally left blank

CONSTRUCTION AND OPERATIONS PLAN

Site Characterization and Assessment of Impacts – Impact Producing Factors

4.2.1 Seafloor and Land Disturbance

Seafloor and land disturbance will result from a variety of activities during construction, O&M, and decommissioning. Seafloor and land disturbance can result in habitat alteration, and the effects of this may be adverse (e.g., elimination or degradation of habitat) or beneficial (e.g., creation or expansion of habitat).

Seafloor and land disturbances are evaluated in several technical studies performed in support of this COP, including the *Sediment Transport Modeling Report* (Appendix H), *Onshore Ecological Assessment and Wetlands Report* (Appendix L), *Benthic Resources Characterization Report – Federal Waters* (Appendix M1), *Essential Fish Habitat Assessment* (Appendix N), and *Terrestrial Archaeological Resources Assessment and Terrestrial Archaeological Resources Phase 1B Assessment* (Appendix S1 and S2); provided under confidential cover).

Project activities that could result in seafloor and/or land disturbance are presented in Table 4.2-1 and are further described below. Impacts to resources from seafloor and/or land disturbance are evaluated in the sections identified in Table 4.2-2.

4.2.1.1 Sunrise Wind Farm

Construction and Decommissioning

During construction of the SRWF, seafloor disturbance will result from several activities associated with seafloor preparation, foundation installation (WTG, OCS–DC), IAC installation, and vessel use and anchoring. Detailed design parameters for these components and activities are described in Section 3.3. Section 3.3 also includes a detailed breakdown of disturbances associated with each Project component. The extent of anticipated seafloor disturbance during construction of the SRWF is presented in Table 3.3.5-2 and Table 3.3.7-2.

Decommissioning will involve removing the structures and foundations in the SRWF to a depth of 15 ft (4.6 m) below the seafloor. The disturbance associated with these activities will be similar to those described for construction, although seafloor preparation activities such as boulder clearing will not occur.

Seafloor Preparation

Seafloor preparation is a temporary, direct disturbance to the seafloor prior to construction and installation activities. Preparation of the seafloor for the SRWF and OCS–DC foundations and for the IAC will generally involve pre-installation surveys, sand wave leveling, and clearance of boulders, debris, and other obstructions in the immediate foundation installation area and along the cable routes. A PLGR will also be completed to clear the cable routes of possible obstructions and debris (e.g., abandoned fishing nets, wires, rope, and hawsers) prior to installation. Further details on activities associated with seafloor preparation are discussed in Section 3.3. Sand wave leveling is considered a short-term seafloor disturbance as the bottom currents that construct and maintain these features will continue to act after the cable is embedded. Boulder clearance is also considered a short-term seafloor disturbance.

Boulders will be relocated to new locations and may be in new physical configurations; however, relatively rapid (< 1 year) recolonization of these boulders is expected (INSPIRE 2016), which will return these boulders to their pre-disturbance function.

CONSTRUCTION AND OPERATIONS PLAN

Site Characterization and Assessment of Impacts – Impact Producing Factors

Foundation Installation

Impact pile driving will be used to install the WTG and the OCS–DC foundations. This activity will disturb the seafloor at the point of pile penetration and the immediately adjacent area. Scour protection may also be placed around each foundation. Installation activities and techniques are described in Section 3.3.5. The PDE parameters for the WTG and OCS–DC foundation types are defined in Table 3.3.5-1.

During construction, DP heavy lift vessels or jack-up vessels equipped with up to four spudcans will be used for foundation installation of the WTGs and OCS–DC. Other vessels, including tugs, material barges, and CTVs may be occasionally anchored using single or multiple anchors. Table 3.3.10-3 outlines the types and number of vessels that will be used during construction. Anchoring results in a range of shallow temporary seafloor disturbances from the penetration of anchors or spudcans, dragging of anchors, and the “sweeping” of anchor chains. Jack-up vessel spudcans will have a maximum penetration depth of 52 ft (15.8 m). Jack up will occur within the 722 ft (220 m) radius cleared around foundation locations during seafloor preparation activities. The extent and severity of seafloor disturbances from vessel anchoring are influenced by several factors including spud or anchor size and configuration, wave and current conditions, vessel drag distances, and the physical and biological characteristics of the seafloor where anchoring occurs.

IAC Installation

The maximum design scenario and maximum seafloor disturbance for the IAC are defined in Table 3.3.7-1 and Table 3.3.7-2, respectively. Disturbance of the seafloor from IAC installation will occur as a result of trenching for cable burial and cable-laying equipment tracks along the seafloor. Seafloor disturbance from IAC installation is narrowly confined to the cable trench, the track width of the cable-laying equipment, and area of cable protection. The submarine cables are expected to be installed using one or more of the following burial techniques (depending on the physical properties of the seafloor and the operating tolerances of the equipment): mechanical plowing, jet-plowing, pre-cut mechanical plowing, pre-cut dredging, mechanical cutting, or CFE (refer to Section 3.3.3.4). The depth of disturbance will be limited to the cross-section of the trench cut for cable laying; the target burial depth will be determined based on an assessment of seafloor conditions, seafloor mobility, the risk of interaction with external hazards such as fishing gear and vessel anchors, and a site-specific Cable Burial Risk Assessment. DP vessels will be used for cable installation to the extent feasible; if anchoring (or a pull ahead anchor) is required during cable installation, it will occur within a corridor centered on the cable. Anchors associated with cable laying vessels will have a maximum penetration depth of 15 ft (4.6 m).

Secondary cable protection will be installed, as needed, in areas where burial cannot occur; sufficient burial depth cannot be achieved to avoid risk of interaction with external hazards; cable joint locations; or where cables cross other existing cables. Where the IAC emerge from the trench and are attached to the foundations, cable protection (e.g., engineered concrete mattresses or rock berms) may be placed on the seafloor near foundations. Trenching is considered a short-term seafloor disturbance while installation of cable protection is considered a long-term seafloor disturbance.

CONSTRUCTION AND OPERATIONS PLAN

Site Characterization and Assessment of Impacts – Impact Producing Factors

Facility Decommissioning

Seafloor disturbance activities that result in the conversion of soft sediment habitats to hard bottom habitat associated with foundations, scour protection, and cable protection (e.g., concrete mattresses or rock berms) in the SRWF and along portions of the SRWEC and IAC, are expected to have long-term beneficial impacts on benthic organisms that rely on complex, hard bottom habitats (see discussion in Section 4.4.2.2). During decommissioning, foundations and other facilities will be removed to a depth of 15 ft (4.6 m) below the mudline, unless otherwise authorized by BOEM (30 CFR § 585.910(a)). Decommissioning would therefore result in the reversal of beneficial effects for species and life stages that inhabited the structures during the life of the Project. Over time, the disturbed area is expected to revert to pre-construction conditions, which would result in a beneficial impact for species and life stages that inhabit soft bottom habitats. Overall, habitat alteration from decommissioning is expected to cause minimal impacts because similar soft and hard bottom habitats are already present in and around the SRWF and SRWEC (Appendices M1, M2, and M3), and the conversion of a relatively small area of habitat is unlikely to result in substantial effects, as any effect observed will be limited to the immediate vicinity of the individual structures.

Operations and Maintenance

Seafloor disturbance during O&M of the SRWF may occur during routine maintenance of bottom-founded infrastructure (e.g., foundations, scour protection, cable protection), non-routine maintenance of the IAC, and anchoring by maintenance vessels. During O&M, anchoring will be limited to vessels that are required to be onsite for an extended duration; typically, CTVs and SOVs are not expected to anchor when visiting the SRWF. Seafloor disturbance is not quantified for O&M of the SRWF as it is expected to be infrequent and minimal. Disturbance associated with non-routine maintenance that may require uncovering and reburial of cables will be similar to that described above for the construction phase, although the extent of disturbance would be limited to specific areas along the cable routes.

4.2.1.2 Sunrise Wind Export Cable

Construction and Decommissioning

This section focuses on submarine segments of the SRWEC. During construction of the SRWEC, seafloor disturbance activities will be similar to those previously identified for the IAC (i.e., will involve seafloor preparation, submarine cable installation, cable protection installation, and vessel anchoring). Detailed design parameters for the SRWEC are described in Section 3.3.3, and Table 3.3.3-5 includes a detailed summary of seafloor disturbances associated with the SRWEC–OCS and SRWEC–NYS.

Where the SRWEC–NYS approaches the landfall location, the cables will be installed via HDD beneath the intertidal transition zone to the onshore TJBs. The HDD methodology will involve drilling underneath the seafloor and the intertidal area using a drilling rig located onshore in the Landfall Work Area. No disturbance to the seafloor is expected between the HDD exit point and the shore because the cable will be installed via HDD. Vessels, including a shallow draught barge or jack-up vessel, will be used to support these operations. For the purposes of impact assessment, land disturbance associated with installation of the HDD for the SRWEC–NYS in the

CONSTRUCTION AND OPERATIONS PLAN

Site Characterization and Assessment of Impacts – Impact Producing Factors

Landfall Work Area between the Mean High Water Line (as defined by the USACE [(33 CFR 329)] and the TJBs is described further below, under 'Onshore Facilities'.

Seafloor disturbance associated with decommissioning of the SRWEC will be similar to that described for construction, although seafloor preparation activities will not occur during decommissioning.

Operations and Maintenance

Seafloor disturbance during O&M of the SRWEC will be limited to non-routine maintenance that may require uncovering and reburial of the cables, as well as maintenance of cable protection and infrequent anchoring of maintenance vessels along the SRWEC route. Seafloor disturbance is not quantified for routine SRWEC O&M as it is expected to be infrequent and minimal.

Seafloor disturbance associated with non-routine maintenance, which may require uncovering and reburial of the cables, would be similar to that described above for the construction phase, although the extent of disturbance would be limited to specific areas along the SRWEC route.

4.2.1.3 Onshore Facilities

Construction and Decommissioning

Land disturbance during the construction phase of the Onshore Facilities will result from site clearance, grading, excavation, and filling during site preparation of the Landfall Work Area, TJB installation, HDD installation for the SRWEC, installation of the Onshore Transmission Cable and Onshore Interconnection Cable, and construction of the OnCS–DC. The construction sequence of these various activities is presented in Section 3.2.2. Detailed design parameters for these components are described in Sections 3.3.1 and 3.3.2, and total anticipated land disturbance for each onshore component is presented in Table 3.3.1-4 and Table 3.3.2-4.

Land disturbance associated with decommissioning of Onshore Facilities is anticipated to be similar to those described for construction, although it is possible that the OnCS–DC will be repurposed or that the Onshore Transmission Cable will be abandoned in place, both of which would limit land disturbance during decommissioning.

Landfall Work Area Site Preparation and Installation of TJBs

As described in Section 3.3.3.3, HDD technology will be used to land the SRWEC–NYS onshore. Site preparation of the work area associated with the landfall and ICW HDD crossings (the Landfall and ICW Work Areas) is limited due to the location of the Landfall Work Area largely within an existing parking lot. The Landfall Work Area will contain HDD activities including installation of the SRWEC to the TJBs, where the SRWEC and Onshore Transmission Cable will be joined. The Landfall and ICW Work Areas will be returned to pre-existing conditions post-construction. Excavators will be used for excavation of TJBs and the TJBs will be located underground with access maintained via manhole covers; therefore, land disturbance associated with the TJBs is considered short-term, as only a small area will be permanently modified by manhole covers. A temporary floating pier may be installed at Smith Point County Park, potentially resulting in temporary disturbance for the modules that may be grounded and the installation of the spuds.

CONSTRUCTION AND OPERATIONS PLAN

Site Characterization and Assessment of Impacts – Impact Producing Factors

Onshore Transmission Cable and Onshore Interconnection Cable Installation

The majority of the Onshore Transmission Cable and Onshore Interconnection Cable routes have been sited within the paved portions of existing roadways. Land disturbance associated with cable installation will therefore be confined to the immediate construction areas and limited to the duration of cable installation activities. The Project will utilize trenchless crossing installation to avoid sensitive environmental resources or other physical obstructions (e.g., railroads) at certain crossing locations. The trenchless installation(s) will either consist of excavating a pair of pits on either side of a crossing or jacking pipe under a crossing (e.g., railroad). Sensitive resources are anticipated to be avoided, and no appreciable change in land cover or imperviousness is expected.

Outside of sensitive areas, excavators will be used for excavation of trenchless crossing work areas, splice vault installation, and trenches. Land disturbance associated with this excavation is considered short-term, as these areas will be backfilled and surface conditions restored to pre-existing conditions, after construction is completed.

Excavation, grading and fill along the roadways may require cutting or trimming of vegetation and removal of large rocks from the construction work area to facilitate safe construction. The disturbance corridor associated with installation of the Onshore Transmission Cable and Onshore Interconnection Cable is described in Section 3.3.2.

OnCS–DC Construction

Land disturbance associated with construction of the OnCS–DC will occur in an industrial area in the Town of Brookhaven, NY. Details of this facility and land disturbance areas to support construction and staging activities are presented in Section 3.3.1. Land disturbance associated with construction activities and staging beyond the footprint itself are considered short-term, as these areas will be restored to pre-existing conditions post-construction or allowed to revert back to pre-existing conditions where appropriate. Tree clearing, as well as excavation, grading, and filling, will be conducted, and expected changes to onsite drainage patterns will be addressed during the EM&CP phase of the Project. All earth disturbances from onshore construction activities will be conducted in compliance with the New York SPDES General Permit for Stormwater Discharges associated with Construction Activities and an approved SWPPP.

Operations and Maintenance

Land disturbance during the O&M phase will occur at the Onshore Facilities if there is a system failure requiring re-excavation of the cable duct banks. Land disturbance associated with O&M of the Onshore Facilities is not quantified for routine Onshore Facilities O&M as it is expected to be infrequent and minimal. Disturbance will be similar to that described above for the construction phase, although the extent of disturbance would be limited to specific areas along the cable routes.

CONSTRUCTION AND OPERATIONS PLAN

Site Characterization and Assessment of Impacts – Impact Producing Factors

4.2.2 Sediment Suspension and Deposition

Sediment suspension and deposition are naturally occurring processes in a highly dynamic oceanographic environment. Suspension of sediments into the water column in excess of what occurs naturally is expected to occur during construction, O&M, and decommissioning activities in the SRWF and SRWEC. Cable burial activities will suspend sediments into the water column, causing short-term localized increases to the natural turbidity. Once in suspension in the water column, these sediments can be transported by currents, eventually settling back onto the seafloor, resulting in localized deposition. Additionally, the placement of infrastructure on the seafloor will have minor changes to the hydrodynamics local to the infrastructure, causing localized movement of surrounding sediment and potential scour of foundations and submarine cable protection.

Increases on localized turbidity and deposition from Project activities depend on the nature and duration of the activity, characteristics of the seafloor (stable or mobile), physical sediment characteristics, and hydrodynamics in the area of disturbance. Project activities that will result in sediment suspension and deposition are presented in Table 4.2-1 and are further described below. Impacts to resources from sediment suspension and deposition are evaluated in the sections identified in Table 4.2-2. A hydrodynamic and sediment transport modeling study was performed to inform evaluation of potential sediment suspension and deposition impacts associated with the Project (Appendix H).

4.2.2.1 Sunrise Wind Farm

Construction and Decommissioning

Sediment suspension and deposition resulting from bottom-disturbing construction and decommissioning activities are expected to be localized and short-term. Temporary sediment suspension and deposition within the SRWF will result from seafloor preparation (including boulder relocation and sand wave leveling), placement of scour protection/cable protection, pile driving installation of monopile foundations or pin pile driving, installation of the IAC, and vessel anchoring. The seafloor overlaying the buried IAC is expected to return to pre-construction conditions over time and no long-term changes to sediment mobility and depositional patterns are expected.

Decommissioning will involve removing the structures and foundations in the SRWF to a depth of 15 ft (4.6 m) below the seafloor. The sediment suspension and deposition associated with these activities will be similar to those described for construction, although seafloor preparation activities such as boulder clearing and sand wave leveling will not occur.

Seafloor Preparation and Foundation Placement

Sediment suspension and deposition will be caused by bottom-disturbing activities during installation of the foundations. The effect of these activities is expected to be localized to the activity and short-term. Physical disturbances from boulder clearance, sand wave leveling, placement of scour protection/cable protection, vessel anchoring, and pile driving will cause small plumes of finer sediments to mobilize up into the water column where limited transport is anticipated. When the activity stops, the sediment suspension will abate, and sediment is expected to settle out onto the seafloor.

CONSTRUCTION AND OPERATIONS PLAN

Site Characterization and Assessment of Impacts – Impact Producing Factors

IAC Installation

The processes of installing the IAC will result in temporary increases in sediment suspension. Associated effects will be short-term and involve a localized suspended sediment plume and related sediment deposition. Some sediment transport is expected outside of the cable trench due to currents, and the exact amount will be dependent on the sediment grain-size, composition, and hydrodynamic forces imposed on the sediment column necessary to achieve desired cable burial depths. However, suspended sediments from the trench are expected to settle primarily back into the cable trench, with limited deposition outside the cable corridor.

Sediment plume modeling was performed to assess potential suspension and deposition impacts from cable installation by mechanical/jet plowing (Appendix H). This study relied on conservative assumptions to represent the source of sediment resuspension from the cable burial activities, where the modeled scenario assumed the method that would create the most sediment disturbance. The conservative modeling of the IAC installation was therefore performed using the jet-plow methodology for two production rate scenarios. Modeling results predict that Project-related sediment suspension and deposition will return to ambient levels (<10 mg/L) within 0.5 hours from installation completion, and maximum suspended concentrations in excess of 100 mg/L will occur within 3,346 ft (1,020 m) of the cable centerline. The total suspended solids (TSS) plume was shown to be primarily contained within the lower portion of the water column, approximately 12.8 ft (3.9 m) above the seafloor. Therefore, sediments are expected to remain in federal waters. Water quality impacts will be short-term and relatively localized. For additional details on sediment movement due to Project activities, refer to Appendix H.

Operations and Maintenance

Once constructed, the presence of the SRWF foundations, scour protection, and cable protection may result in localized changes to seafloor topography and bottom currents. Sediment suspension and deposition will also be locally altered due to the changes in seafloor topography and hydrodynamics. Post-construction seafloor surveys of the Block Island Wind Farm documented that dynamic, mobile, and sandy seafloor types were observed to recover more quickly than stable seafloor types consisting of cobble and gravel (INSPIRE 2016). The sediment around the foundations will experience scour and backfilling subject to wave and current action with localized increases in turbidity. Potentially adverse impacts from these processes will be mitigated by installing scour protection for the foundations. Scour protection is discussed in more detail in Section 3.3.5, and the impact parameters for scour protection are presented in Table 3.3.5-2.

A limited amount of sediment suspension and deposition may also occur during O&M of the SRWF in connection with routine maintenance of bottom-founded infrastructure (e.g., foundations, scour protection, cable protection), non-routine maintenance of the IAC, and anchoring by maintenance vessels. Hydrodynamic and sediment transport modeling was not conducted for the O&M phase of the SRWF as sediment transport is expected to occur at lower levels than during construction and decommissioning activities and be localized to anchoring activities of vessels.

CONSTRUCTION AND OPERATIONS PLAN

Site Characterization and Assessment of Impacts – Impact Producing Factors

However, should a segment of the IAC need to be uncovered for repair or replacement and reburied, it is assumed that these activities would have impacts similar to those modeled for the construction phase, as outlined above.

4.2.2.2 Sunrise Wind Export Cable

Construction and Decommissioning

Sediment suspension and deposition resulting from bottom-disturbing construction and decommissioning activities associated with the SRWEC are expected to be localized and short-term. Temporary sediment suspension and deposition within the SRWEC corridor will result from seafloor preparation (including boulder relocation and sand wave leveling), installation of the SRWEC, placement of cable protection, and vessel anchoring. The seafloor overlaying the buried SRWEC is expected to return to pre-construction conditions over time and no long-term changes to sediment mobility and depositional patterns are expected.

During decommissioning, SRWEC removal activities are expected to produce sediment and deposition effects that are similar to the installation process. These two activities (installation and removal) would occur decades apart from each other and would each have short-term, localized impacts.

Seafloor Preparation

Sediment suspension and deposition will be caused by bottom-disturbing activities during installation of the SRWEC. The effect of these activities is expected to be localized to the activity and short-term. Physical disturbances from boulder clearance, sand wave leveling, placement of cable protection, and vessel anchoring (as detailed in Section 3.3.3) will cause small plumes of sediment to mobilize up into the water column where limited transport is anticipated. When the activity stops, the sediment suspension will abate, and sediment is expected to settle out onto the seafloor. As further detailed in Appendix H, the Project-specific hydrodynamic and sediment transport modeling assessment considered CFE and/or a trailing suction hopper dredge may be used for sand wave leveling, and evaluated potential disposal methods that would create the most sediment disturbance. Modeling results predict TSS concentrations returning to ambient levels (<10 mg/L) for both construction methods within 0.42 hours from completion of the activity in federal waters, and within 0.5 hours from completion in NYS waters. Using CFE, maximum suspended sediment concentrations in excess of 100 mg/L were not shown to occur during sand wave leveling for the modeled SRWEC–OCS and were shown to occur within 253 ft (77 m) of the modeled SRWEC–NYS cable corridor centerline. Use of a trailing suction hopper dredge with hydraulic disposal at the surface produced maximum suspended sediment concentrations in excess of 100 mg/L within 820 ft (250 m) of the modeled SRWEC–OCS cable corridor centerline and within 6,775 ft (2,065 m) of the modeled SRWEC–NYS cable corridor centerline. The TSS plumes using a trailing suction hopper dredge with bulk disposal were shown to have maximum suspended sediment concentrations in excess of 100 mg/L within 5,052 ft (1,540 m) of the modeled SRWEC–OCS cable corridor centerline and within 5,427 ft (1,654 m) of the modeled SRWEC–NYS cable corridor centerline.

CONSTRUCTION AND OPERATIONS PLAN

Site Characterization and Assessment of Impacts – Impact Producing Factors

SRWEC Installation

The processes of installing the SRWEC will be similar to the discussion above for the IAC and will result in temporary increases in sediment suspension. Associated effects will be short-term and involve a localized suspended sediment plume and related sediment deposition.

Some sediment transport is expected outside of the cable trench due to currents; however, the majority are expected to settle back into the cable trench, with limited deposition outside the cable corridor. Cable installation techniques are detailed in Section 3.3.3. As further detailed in Appendix H, the Project-specific hydrodynamic and sediment transport modeling assessment relied on the conservative assumption that jet-plowing may be used to install the SRWEC, as that method would create the most sediment disturbance. Modeling results predict TSS concentrations returning to ambient levels (<10 mg/L) within 0.4 hours from completion of the SRWEC–OCS installation, and within 0.34 hours from completion of the SRWEC–NYS installation.

Furthermore, maximum suspended sediment concentrations in excess of 100 mg/L were shown to occur during cable installation within 2,969 ft (905 m) of the modeled SRWEC–OCS cable corridor centerline and were not shown to occur for the modeled SRWEC–NYS. The TSS plumes are expected to be contained within the lower portion of the water column, approximately 8.2–9.8 ft (2.5–3.0 m) above the seafloor for both SRWEC–OCS and SRWEC–NYS installation.

Operations and Maintenance

Cable protection may be placed over the SRWEC–OCS and SRWEC–NYS where target burial depth is not achieved, at cable joint locations, and at crossings of existing telecommunications cables. The introduction of rock or engineered concrete mattresses to areas of the seafloor can cause local disruptions to circulation, currents, and natural sediment transport patterns.

Under normal circumstances, these segments of the SRWEC are expected to remain covered as accretion of sediment covers the cable and the cable protection. In non-routine maintenance situations, these segments may be uncovered, and re-burial might be required.

Hydrodynamic and sediment transport modeling was not conducted for the O&M phase of the SRWEC as sediment transport is anticipated to occur at lower levels than during construction and decommissioning activities and be localized to anchoring activities of vessels. However, should a segment of the SRWEC need to be uncovered and reburied for repair or replacement, it is assumed that these activities would have impacts similar to those modeled for the construction phase, as outlined above.

The seafloor is expected to return to pre-construction conditions over time and no long-term changes to sediment mobility and depositional patterns would be expected during O&M, apart from areas where secondary cable protection is required. In the rare instance that the SRWEC must be visually inspected or repaired during O&M, excavation in and around the SRWEC would result in short-term, localized sediment suspension and deposition.

CONSTRUCTION AND OPERATIONS PLAN

Site Characterization and Assessment of Impacts – Impact Producing Factors

4.2.2.3 Onshore Facilities

Construction and Decommissioning

Construction of the Onshore Facilities will be governed by several environmental permits including the NYSDEC SPDES General Permit for Stormwater Discharges from Construction Activity. One of the requirements of the SPDES General Permit is the development of a SWPPP, which will address stormwater management and temporary soil erosion, identifying site-specific measures to minimize pollution associated with stormwater runoff. The measures employed in the SWPPP minimize the opportunity for turbid discharges leaving a construction work area. The plan also includes specific measures for handling dewatering discharges and measures for refueling equipment to minimize the opportunities for uncontrolled spills. Onshore construction activities causing earth disturbance and the potential for soil erosion and sedimentation will be further addressed by the NYSDEC's Article VII Certification and associated EM&CP detailing site-specific construction activities and the environmental BMPs to be implemented, which will be filed prior to construction. The construction and decommissioning phases of the Onshore Facilities are not anticipated to have more than a short-term effect on turbidity and sediment deposition.

Operations and Maintenance

The O&M phase of the Project is not expected to create any significant opportunity for soil erosion or the conveyance of sediment to surface waters.

4.2.3 Noise

Noise is defined as unwanted sound, whether underwater or in-air (i.e., airborne). Sound becomes an adverse impact when it interferes with the normal habits, health, or activities of receptors, such as fish, wildlife, or people. Recognition or perception of sound as noise, however, is very subjective and circumstantial based on the receptor's experience as well as the characteristics of the sound. The reception and perception of sound depends on many factors including the sound source (power level), frequency, distance between source and receptor, received sound pressure level (SPL), receptor's hearing capability and physiology, context (activity in which a receptor is engaged) and a suite of environmental factors including media (air, water, sediment), temperature, barriers, and other sounds. Sound levels are most often measured on a logarithmic scale of decibels (dB) relative to 20 micro-pascals (μPa) in air and relative to 1 μPa in water. Since airborne and underwater sound levels are based on different reference levels, they cannot be directly compared. For some activities, such as pile driving for foundations, both airborne and underwater sounds will be generated. In this section, sources of noise from Project activities are identified and discussed as potential IPFs.

CONSTRUCTION AND OPERATIONS PLAN

Site Characterization and Assessment of Impacts – Impact Producing Factors

Noises generated by the Project will transmit through the water, air, or both. Underwater noises are those that transmit through the water column as a result of working engines or machines below the surface of the water (for example, vessel propeller or thruster) or noise transmitted through an underwater structure or the seafloor as waves of energy that propagate sound throughout the water column during construction (pile-driving) or operation (WTG spinning). In-air noises refer to those that are generated above the surface of the water and transmitted through the atmosphere. For some activities, both in-air and underwater noises will be generated. During impact or vibratory pile driving, for example, the pile driving hammer impacts the top of the steel pile generating sound waves that travel through the pile and radiating out into the water column as well as in the air above the water. Vibrating or noise-emitting activity and equipment abovedeck on work vessels can also generate sound that radiates both in-air and below the water in a similar way.

Three studies were conducted to evaluate Project-related noise in support of this COP:

- 1) Appendix I1 – *Underwater Acoustic Assessment*, provided under confidential cover;
- 2) Appendix I2 – *Onshore Acoustic Assessment*; and 3) an evaluation of potential in-air noise impacts for offshore components (Appendix I3 – *Offshore In-Air Acoustic Assessment*).

Summary-level information from the results of these studies is included in this section.

Project activities that are expected to generate noise are presented in Table 4.2-1 and are further described below. Impacts to resources from noise are evaluated in the sections identified in Table 4.2-2.

4.2.3.1 Sunrise Wind Farm

Construction and Decommissioning

Underwater and in-air sound will be generated during construction and decommissioning of the SRWF and the OCS-DC as a result of pre-construction high-resolution geophysical (HRG) surveys, vessel and aircraft traffic, impact pile-driving, and other power equipment used to install the WTGs (e.g., cranes, compressors) and IAC. Decommissioning may result in similar noise generation if it involves the removal of Project components with comparable equipment and methods as construction. The various sound-generating activities associated with construction and decommissioning of the SRWF are further described and assessed below.

Vessel and Aircraft Noise

Several types of vessels will be used during construction activities, as detailed in Table 3.3.10-3. For each vessel type, the route plan for the vessel operation area will be developed to meet industry guidelines and best practices in accordance with International Chamber of Shipping guidance. These types of vessels will generate sound similar to vessels already operating in the waterways.

Helicopters will be used for additional crew transfers during construction activities. A helicopter route plan will be developed to meet industry guidelines and best practices in accordance with FAA guidance.

CONSTRUCTION AND OPERATIONS PLAN

Site Characterization and Assessment of Impacts – Impact Producing Factors

Impact Pile-Driving Noise

In-air and underwater noise will result from the use of impact pile drivers to install the SRWF foundations. Pile driving sound levels vary with pile size (diameter and wall thickness), subsurface/geotechnical characteristics, hammer energy, and type of pile driver. Pile driving sounds propagate both above and below the sea surface, although sound transmission is different in water than in air, making it difficult to compare airborne and underwater sound levels.

Impact pile-drivers typically utilize a weight (sometimes referred to as a piston or hammer) to impact the top of a pile to force it into the seafloor. The repetitive hammer blows drive the pile into the seafloor, similar to hammering a nail into a piece of wood. Piles are driven until the desired resistance is achieved (typically measured in blow counts per foot or inch) or the pile fails to advance (known as refusal). The primary sources of noise associated with impact driving are the impact of the hammer on the pile/drive cap and the noise radiated from the pile.

Driving of monopiles and piled jackets will generate in-air impulse sounds as the hammer strikes the pile. This sound source will only last as long as the duration of pile driving and take place exclusively offshore in the SRWF. As further detailed in Appendix I3, predicted average airborne sound levels from pile driving activities range from 60 dB on the A-weighted scale (dBA, an expression of the relative loudness of sounds in air as perceived by the human ear) at 2,400 ft (732 m) distance to 94 dBA at 50 ft (15 m) distance. Additionally, results of Block Island Wind Farm noise monitoring efforts showed that sound levels detected onshore during pile driving activities occurring 4 mi (3.5 nm, 1.6 km) offshore ranged from 40 to 65 dB when measured onshore (BOEM 2018). These levels are comparable to typical conversation noise levels (50 to 65 dB), as presented in Appendix I3. Considering the predicted airborne sound levels from typical pile driving activities and the distance of the SRWF from shore, no pile driving noises from SRWF pile driving activities are expected to reach the shore. Underwater noise from pile driving is considered an IPF because of its potential impacts on marine life such as marine mammals, sea turtles, and certain finfish and shellfish. To define underwater impulsive sounds from pile driving, Sunrise Wind completed an acoustic modeling study, which is presented in Appendix I1. The acoustic model was used to predict the propagation of underwater sound and was further refined based on input from pile driving data available from European offshore wind farms. The sound propagation modeling incorporates site-specific environmental data that describes the bathymetry, sound speed in the water column, and seafloor geoacoustics in the SRWF. Modeling estimated the distances of impulse sound propagation to certain acoustic thresholds as published by federal and state agencies for marine mammals, sea turtles, and finfish. These distances are used to define this particular IPF and the evaluations are presented in Sections 4.4.3, 4.4.4, and 4.4.5, and Appendices I1 and O – *Marine Mammals, Sea Turtles, and ESA-Listed Fish Species Assessment*.

Operations and Maintenance

The potential for noise to be generated during O&M is the result of operation of the WTGs, OCS–DC, and nautical hazard prevention devices (foghorns), vessel and aircraft traffic, as well as seafloor surveys. Noise generated from these components is described below.

CONSTRUCTION AND OPERATIONS PLAN

Site Characterization and Assessment of Impacts – Impact Producing Factors

WTG and OCS–DC Operational Noise

WTGs produce aerodynamic turbine blade noise and mechanical noise. Sound from operation of the WTGs has been modeled assuming they are all operating continuously and concurrently at the typical maximum rated sound power level of 120 dBA per WTG. These sound levels include mechanical and aerodynamic sources of the WTGs. Since WTGs typically radiate more sound in certain directions, the sound measurement test standard accounts for the maximum directional sound power level. Therefore, the sound emissions are worst-case as they relate to directivity.

The frequency and sound level generated from operating WTGs depends on WTG size, wind speed and rotation, foundation type, water depth, seafloor characteristics, and wave conditions (Cheesman 2016). Collett and Mason (2014) found that noise from operating 6 MW turbines dropped to ambient levels at approximately 328 ft (100 m) from the turbine, a study by Miller and Potty (2017) measured root mean square sound pressure levels (SPL_{rms}) of 100 dB re 1 μ Pa 164 ft (50 m) from a set of five General Electric Haliade 150-6 MW wind turbines, and other studies in Europe estimated SPL_{rms} of operational WTG noise ranging from 125 to 130 dB re 1 μ Pa across all octave bands (Lindeboom et al. 2011; Tougaard et al. 2009). After construction of the Block Island Wind Farm was complete, continuous airborne noise monitoring was conducted at an onshore location over a three-month period to record operational WTG sound levels. Results showed no airborne noise from operational WTGs detected at any time during the three-month period of monitoring (BOEM 2019). Additionally, airborne noise monitoring was conducted offshore at the Block Island Wind Farm. Results showed noise levels of 65 dB A-weighted, equivalent continuous sound level (L_{Aeq}) at the nearest location to the WTG (164 ft [50 m]); however, it was noted that the level of noise appeared to be significantly influenced by natural ambient noise, suggesting the airborne noise from WTG operation would likely be less than 65 dB L_{Aeq} (BOEM 2019). Airborne noise modeling was also conducted in April 2012 for the Beatrice Offshore Wind Farm located approximately 8 mi (7.0 nm, 12.9 km) off the coast of Scotland. Modeling results concluded that the predicted noise level at the nearest point on the shoreline from the 7-MW operational offshore WTGs would range from 26 to 27 dBA, dependent on the condition of the water's surface (Beatrice Offshore Wind Farm 2012). Anticipated sound levels per the modeling and monitoring studies described will be within, or less than, the range of typical New York daytime sound level estimates (35 to 55 dBA).

The loudest source of sound from the OCS–DC during operation is the emergency diesel generator. The sound emissions of the generator depend primarily on the sound attenuation performance of the acoustic enclosure and exhaust silencer. Although the specific manufacturer, model, and sound attenuation specifications of the generator have not yet been determined, the sound emissions are expected to be typically lower than the WTG. The buffering nature of the water is expected to mute any operational noise underwater.

CONSTRUCTION AND OPERATIONS PLAN

Site Characterization and Assessment of Impacts – Impact Producing Factors

Nautical Hazard Prevention Noise

Audible nautical hazard prevention devices (i.e., foghorns) will be installed on select WTGs along the outer perimeter of the SRWF. The foghorns are designed to provide a 2.30-mi (2.0-nm; 3.7-km) audible range and emit a 134 dB tone at a frequency of 660 Hertz (Hz) at 3 ft (1 m). Regulations in 33 CFR § 67 specify that foghorns are to be installed less than 150 ft (46 m) above mean sea level (AMSL). The foghorn will be placed atop the transition deck at a maximum of 132 ft (40 m) AMSL and will be equipped with fog detection device and allow for remote operation by passing vessel (i.e., non-continuous). Noise from hazard prevention devices is expected to be muted underwater, and although it may be heard from shore, the noise will not be at harmful or nuisance levels.

Vessel and Aircraft Noise

During O&M, vessel noise will result from routine trips to the SRWF or in cases of emergency (see Table 3.5.5-1). Noise is expected to be generally the same as discussed for construction. The helicopter routes will be developed to meet industry guidelines and best practices in accordance with FAA guidance.

Seafloor Surveys

During O&M, geophysical surveys of the seafloor will occur as part of routine maintenance of offshore cables and foundations. Surveys will monitor bathymetry, cable burial depth, cable protection, and scour. For the SRWEC, IAC, and foundations, seafloor surveys would occur at one year after commissioning, two to three years after commissioning, and five to eight years after commissioning, with frequency thereafter depending upon the findings of the initial surveys. The underwater and in-air noise generated from equipment and vessels during these seafloor surveys would be similar to that occurring during site assessment of the Project Area; however, some of the equipment with higher SPL, such as the sub-bottom profiler, are not anticipated to be used to support the O&M seafloor surveys.

4.2.3.2 Sunrise Wind Export Cable

Construction and Decommissioning

Noise will be generated during SRWEC construction and decommissioning by vessel use, including DP vessels for cable installation, aircraft use, and use of construction vehicles and equipment at ports. The noise generated will be similar to described above for the SRWF.

Operations and Maintenance

Noise from vessel and aircraft traffic during O&M of the SRWEC is expected to be generally similar as discussed for O&M of the SRWF.

4.2.3.3 Onshore Facilities

Construction and Decommissioning

Noise will be generated during construction of Onshore Facilities from HDD operations, installation of the Onshore Transmission Cable and Onshore Interconnection Cable, installation of the OnCS–DC, and vehicular traffic.

CONSTRUCTION AND OPERATIONS PLAN

Site Characterization and Assessment of Impacts – Impact Producing Factors

Sunrise Wind modeled construction noise for the Onshore Transmission Cable components listed above using standard methods for energy and transmission line projects in a manner that is consistent with federal and state guidelines (Appendix I2). Noise emissions of construction equipment is based on reference data from the Federal Highway Administration (FHWA) Roadway Construction Noise Model (RCNM) and other Project-specific equipment specifications. RCNM includes a database of sound emissions for commonly used construction equipment such as dump trucks, backhoes, concrete saws, air compressors, and portable generators.

HDD/Trenchless Crossing Construction Noise

Temporary noise will be generated from HDD operations and installation of trenchless crossings. These activities are assumed to include site preparation, drilling operations including cable installation, and restoration, as further detailed in Appendix I2. HDD will be used to connect the SRWEC offshore to the Onshore Transmission Cable at the Landfall HDD and at the ICW HDD. In addition, HDD or horizontal auger boring (HAB) construction is anticipated at five trenchless crossings along the Onshore Transmission Cable and Onshore Interconnection Cable routes. Multiple construction phases are anticipated at HDD and HAB sites including site preparation and drilling operations, as further detailed in Appendix I2.

Given the proximity of noise sensitive receptors (NSRs) at all trenchless crossings, noise from site preparation will exceed the NYSDEC criterion of 65 dB in residential areas if unmitigated. At some trenchless crossings, the NYSDEC criterion of 79 dB in commercial areas will also be exceeded. While these construction activities are short term, mitigative measures as outlined in Appendix I2 are warranted to attenuate construction noise at NSRs.

Construction activities associated with site preparation at HDD and HAB sites will generate noise of approximately 84 dB at a distance of 50 ft (15 m) after implementing noise control strategies. No further mitigation is required at the Landfall HDD, the ICW HDD, or the trenchless crossing location along the Onshore Interconnection Cable route as the specified controls are anticipated to reduce noise at NSRs) below permissible limits. BMPs outlined in Appendix I2 will be implemented to further reduce noise at noise sensitive receptors for all trenchless crossing locations along the Onshore Transmission Cable route.

Mitigative measures are warranted at all HAB and HDD sites along the Onshore Transmission Cable route to attenuate construction noise from drilling operations below permissible noise limits, as detailed in Appendix I2. After implementing feasible noise controls, construction activity at the trenchless crossings of Sunrise Highway at Revilo Avenue and Carmans River at Victory Avenue is expected to temporarily exceed the permissible sound level as specified by NYSDEC or Suffolk County at one or more NSRs. Drilling operations at all other sites will comply with all applicable regulations. At the ICW HDD and most trenchless crossings, the expected increase in the ambient sound level from existing conditions necessitates that BMPs be implemented to further diminish construction noise at NSRs per NYSDEC policy. Drilling operations will require continuous operation over several months and may include nighttime construction.

CONSTRUCTION AND OPERATIONS PLAN

Site Characterization and Assessment of Impacts – Impact Producing Factors

The exit side of the Landfall HDD is located approximately 0.5 mi (800 m) offshore. Construction at this site will include installation of a casing pipe using pneumatic impact equipment and installation of sheet piles using an impact hammer. These activities will occur during the daytime and are expected to produce a sound level of approximately 60 dB or less at the nearest shoreline location, as further detailed in Appendix I2. Since noise from construction at the Landfall HDD exit site will be below all applicable criteria, mitigation to attenuate construction noise is not warranted.

Onshore Transmission Cable and Onshore Interconnection Cable Installation Noise

Construction activities would introduce temporary noise sources associated with the different phases of installation for the Onshore Transmission Cable and Onshore Interconnection Cable. These activities are assumed to include clearing the ROW, removing pavement, trenching, laying pipe, constructing the duct bank and vaults, installing and testing cable, and site restoration. Based on the results of the modeling, construction will generate noise of approximately 88 dB at a distance of 40 ft (12 m) from the center of construction activities. Construction noise will exceed 65 dB at distances of up to 550 ft (168 m). The NYSDEC noise limit is likely to be exceeded at residential NSRs adjacent to the Onshore Transmission Cable route as well as at the Onshore Interconnection Cable route; therefore, BMPs outlined in Section 6 of Appendix I2 will be implemented to diminish construction noise impacts. Because construction will continuously progress along the route, exposure to noise at any particular location will be temporary. In some areas, construction along the route may be required to occur at night to mitigate traffic impacts.

OnCS–DC Installation Noise

Installation of the OnCS–DC would introduce temporary noise sources. These activities are assumed to include site preparation, construction of foundations and buildings, installation of equipment, and finishing, over a 24-month period occurring during daytime hours, as further detailed in Appendix I2. During daytime hours, construction noise is exempt from both the Town of Brookhaven and Suffolk County noise ordinances; however, noise at NSRs should be limited to 65 dB at residential properties and 79 dB at industrial properties per NYSDEC policy.

Construction of the OnCS–DC at the Union Avenue Site will generate a sound level of approximately 86 dB at a distance of 50-ft (15-m) from the center of the activity, 79 dB at a distance of 110 ft (33.5 m), and 65 dB at a distance of 550 ft (167.6 m). The nearest noise sensitive receptor is approximately 1,300 ft (396 m) away from the center of construction activities, and approximately 984 ft (300 m) from the southern property line of the Union Avenue Site. Construction noise at that distance is anticipated to be 58 dB, and would be lower at all other NSRs in residential areas, per results of modeling efforts (Appendix I2). This indicates that the sound level of construction noise at residential NSRs would be similar to existing conditions. The closest industrial properties are approximately 220 ft (67 m) away from the center of construction activities at the Union Avenue Site. Construction is expected to generate noise of approximately 73 dB at the closest noise sensitive receptor in an industrial area. Therefore, modeling indicates that construction noise at the Union Avenue Site would not exceed permissible sound level limits at NSRs. Construction noise is expected to exceed 65 dB at nearby industrial NSRs and BMPs will be implemented to minimize noise per NYSDEC policy.

CONSTRUCTION AND OPERATIONS PLAN

Site Characterization and Assessment of Impacts – Impact Producing Factors

Vehicular Traffic

Construction of the Onshore Facilities will require a temporary increase in construction vehicle-related traffic, and associated vehicle noise within the relatively dense, residential areas of Town of Brookhaven, NY, including the area around Smith Point County Park. Vehicles will include heavy equipment (e.g., excavators, cranes, dump trucks, and paving equipment) and the increase in noise levels is expected to be comparable to that experienced during typical roadway or utility construction work. This IPF will cease following completion of the specific construction activities.

Operations and Maintenance

The only noise regularly expected during O&M is operation of the OnCS–DC. Noise from routine O&M of the Onshore Transmission Cable and Onshore Interconnection Cable is not anticipated, except during routine maintenance that may require short-term use of equipment with noise emissions to facilitate inspections and repairs.

OnCS–DC Operational Noise

Operation of the OnCS–DC would introduce new sources of noise. Predictive models of the operating OnCS–DC assumed simultaneous operation of the transformers and other prominent components under maximum operating conditions, and operational noise was assumed to be constant over 24 hours of the day. The most prominent noise sources of an operating OnCS–DC are the converter transformers, reactors, filters, and outdoor cooling equipment associated with the valve hall. Other noise sources such as corona sources, switching devices, generators, DC equipment, and thyristor valves are transient, insulated within buildings, or otherwise do not typically make significant contributions to the overall equivalent continuous sound level.

Results of the modeling of in-air noise from the OnCS–DC located at the Union Avenue Site indicate that operational noise at the nearest NSRs will range from 28 to 67 dB. The Project sound level at the closest residence will be 42 dB, which will result in an increase of 0 dB in the total sound level relative to existing conditions. These results provide an indication of the noise that can be expected with application of the proposed mitigative measures. As specified in Appendix I2, the predicted total sound levels of the OnCS–DC comply with all applicable criteria as specified by the EPA, NYSDEC, and the Town of Brookhaven. For additional data on the predicted operational noise from the OnCS–DC, see Table 17 in Appendix I2.

4.2.4 Electric and Magnetic Fields

EMF are produced by electric charges and the movement of electric charges, respectively, and are present in the marine environment from both natural and anthropogenic sources. The most common naturally occurring DC field is Earth's 0-Hz geomagnetic field, while most natural AC fields in the marine environment are electric fields, which are produced by marine organisms and occur at frequencies less than 10 Hz.

CONSTRUCTION AND OPERATIONS PLAN

Site Characterization and Assessment of Impacts – Impact Producing Factors

The PDE includes both AC (IAC and Onshore Interconnection Cable) and DC (SRWEC and Onshore Transmission Cable) electrical technologies. Electricity from the WTGs will be carried at a voltage of 66 to 161 kV by the IAC and will be collected at an OCS–DC, where the voltage will be increased and converted from AC to DC. A pair of DC cables (bundled together) will transfer power to shore. The Onshore Transmission Cable will be installed in underground duct banks.

Each of the electrical elements for the Project, including the IAC, SRWEC, Onshore Transmission Cable and at the WTGs and OCS–DC— will be sources of magnetic fields and induced electric fields. There are 0-Hz (i.e., static) magnetic fields associated with the DC cables in the offshore portion of the SRWEC, as well as at representative structure foundations.

Both magnetic fields and induced electric fields from submarine cables are of environmental and ecological interest because research shows that some marine species have specialized sensory receptors that are capable of detecting magnetic fields or electric fields, or both, in the natural environment. Offshore and onshore EMF assessments were conducted in support of the Project (Appendix J1– *Offshore EMF Assessment* and J2 – *Onshore EMF Assessment*).

Project activities that could produce EMF are presented in Table 4.2-1 and are further described below. Impacts to resources from EMF are evaluated in the sections identified in Table 4.2-2.

4.2.4.1 Sunrise Wind Farm

Construction and Decommissioning

Construction of the WTGS, OCS–DC, and IAC does not produce EMF. The EMF present during operations (discussed below) will cease once the Project is decommissioned.

Operations and Maintenance

Operation of the WTGs does not generate EMF; however, once the IAC become energized, the cables will produce a magnetic field in the surrounding seawater, both perpendicularly and in a lateral direction around the cables. The IAC will be AC and while there will be no EMF emissions from the OCS–DC itself, several cables connect with this structure and the cables will emit EMF when energized. Modeling was performed at peak loading and included separate assessments for the base of structures near the seabed area and portions of the structures higher in the water column. The calculated maximum volume-averaged DC magnetic field level (calculated higher in the water column for the OCS–DC piled jacket foundation) at peak loading was 4,413 mG (including 506 mG contributed by the geomagnetic field of the Earth).

CONSTRUCTION AND OPERATIONS PLAN

Site Characterization and Assessment of Impacts – Impact Producing Factors

Sunrise Wind conducted an assessment of the potential for EMF generation from the IAC Cable (Appendix J1) and included an assessment of the potential impacts on marine life as appropriate (described further in Section 4.0) for both AC and DC cables. The modeling of magnetic field and induced electric fields was used in the analysis of the available scientific literature on the sensitivity of marine species to EMF, as described in Section 4.4. This assessment used a conservative minimum target burial for all cases and assumed no shielding effect of cable sheathing or armoring. The proposed separation of the IAC was modeled in isolation from one another. Based on the results of the modeling, the magnetic fields and induced electric fields from operational AC cables (i.e., IAC) will attenuate quickly with increasing distance. Directly over the cables at peak loading, AC magnetic- and induced electric-field levels were calculated to be 4.5 mG and <0.1 millivolts/meter (mV/m), decreasing to 1.1 mG and <0.1 mV/m or less at a horizontal distance of ±10 ft (3 m) from the cables.

4.2.4.2 Sunrise Wind Export Cable

Construction and Decommissioning

No EMF will be produced during construction of the SRWEC. The EMF present during operations (discussed below) will cease once the Project is decommissioned.

Operations and Maintenance

As described above, Sunrise Wind conducted an assessment of the EMF from the SRWEC (Appendix J1).

This assessment used a conservative minimum target burial depth of 3.3 ft (1 m). Modeling results indicate that DC magnetic field levels will generally be quite low and decrease rapidly with distance.

DC magnetic fields evaluated at a height of 3.3 ft (1 m) above the SRWEC at peak loading (assessed for all permutations of four geographic directions and four cable configurations) are calculated to change Earth's ambient geomagnetic field by a maximum of ±129 mG, decreasing to ±41 mG a horizontal distance of 10 ft (3 m) from the cables, representing a change of less than 10 percent of the ambient geomagnetic field level of approximately 506 mG. Induced DC electric fields in an ocean current of 2 ft/s (60 centimeters per second [cm/s]) are dominated by the effects of Earth's ambient geomagnetic field and are calculated to be 0.038 mV/m directly above the SRWEC, decreasing to 0.033 mV/m at a distance of ±10 ft (3 m).

4.2.4.3 Onshore Facilities

Construction and Decommissioning

There will be no EMF produced during construction of the Onshore Facilities. The EMF present during operations (discussed below) will cease once the Project is decommissioned.

CONSTRUCTION AND OPERATIONS PLAN

Site Characterization and Assessment of Impacts – Impact Producing Factors

Operations and Maintenance

Sunrise Wind conducted an assessment of the for EMF from the Onshore Transmission Cable (DC fields) and Onshore Interconnection Cable (AC fields) (Appendix J2). The Onshore Transmission Cable will be installed in an underground duct bank buried 3 ft (0.9 m) with short portions of the route installed in a direct bury configuration.

- Modeling results showed that at the DC duct bank, the largest change in magnetic field (relative to Earth's ambient geomagnetic field of 506 mG) at 3.3 ft (1 m) above ground at average loading is ± 202 mG decreasing quickly to ± 51 mG or less within ± 10 ft (3 m) from the duct bank field levels. Where the Onshore Transmission Cable is installed via direct bury, the modeled DC magnetic-field levels (and deviations) were determined to be much lower with a maximum deviation of approximately ± 38 mG relative to Earth's ambient geomagnetic field.

Magnetic-field levels are typically assessed in terms of standards and guidelines developed by scientific and health agencies to protect health and safety and are based on reviews and evaluations of relevant health research. The calculated DC magnetic-field levels directly above the Onshore Transmission Cable at average peak loading are far below the International Commission for Non-Ionizing Radiation Protection's (ICNIRP)'s standard for human exposure to static magnetic fields (i.e., < 0.1 percent of the general public exposure limit of 4,000,000 mG) for all cable configurations evaluated.

The AC and DC magnetic fields associated with the operation of equipment within the OnCS–DC were not calculated, as the highest magnetic-field levels around the perimeter of these facilities will be due to the Onshore Transmission Cable and Onshore Interconnection Cable entering and exiting the substation.

4.2.5 Discharges and Releases

Discharges and releases of liquids and solid waste to the ocean or land pose a threat to water quality and risks to marine life from exposure and ingestion. Per the information requirements outlined in 30 CFR 585.626, maximum quantities and disposal methods for liquids and solid wastes, including hazardous materials, are summarized in Section 3.3.10.3 and in particular Table 3.3.10-3 for offshore construction, and in Section 3.5.3 and Table 3.5.3-1 for offshore O&M. Appendix E1 includes additional information about the potential discharges and potential methods of treatment. Project activities that could result in discharges or releases of liquids and solid waste are presented in Table 4.2-1 and are further described below. Impacts to resources from discharges and releases are evaluated in the sections identified in Table 4.2-2.

4.2.5.1 Sunrise Wind Farm

Construction and Decommissioning

Routine or accidental (non-routine) fuel spills, wastewater discharges, and solid waste releases are possible but considered unlikely during normal construction and decommissioning activities for the SRWF.

CONSTRUCTION AND OPERATIONS PLAN

Site Characterization and Assessment of Impacts – Impact Producing Factors

Routine Discharges and Disposal

Routine discharges of wastewater (e.g., gray water or black water) or liquids (e.g., ballast, bilge, deck drainage, stormwater) outside of state waters may occur from vessels during construction and decommissioning of WTGs or the OCS–DC; however, those discharges and releases are anticipated to have negligible impacts because all vessel waste will be offloaded, stored, and disposed of in accordance with all applicable local, state, and federal regulations, such as the EPA and USCG requirements for discharges and releases to surface waters. In addition, compliance with applicable Project-specific management practices and requirements will minimize the potential for adversely impacting water quality and marine life.

In accordance with the *Oil Pollution Act* of 1990 and the International Convention for the Prevention of Pollution by Ships (known as MARPOL 73/78), owners and operators of certain vessels are required to prepare Vessel Response Plans approved by the USCG. In addition, the USCG regulates the at-sea discharges of vessel-generated waste under the authority of the *Act to Prevent Pollution from Ships* (33 USC 1905-1915). All vessels will comply with USCG standards in US territorial waters to legally discharge uncontaminated ballast and bilge water, and standards regarding ballast water management. Outside of US territorial waters, vessels will be compliant with the IMO Ballast Water Management Convention standards. All Project vessels will be required to comply with the applicable USCG pollution prevention requirements. Additionally, all vessels less than 79 ft (24.1 m) will comply with the Small Vessel General Permit issued by EPA on September 10, 2014 for compliance with NPDES permitting.

Accidental or Non-Routine Spills or Releases

During construction and decommissioning, there is increased probability of spills and accidental releases of fuels, lubricants, and hydraulic fluids. BMPs for fueling and power equipment servicing greatly minimize the potential for spills and accidental releases and will be incorporated into the OSRP (Appendix E1). Accidental releases are minimized by containment and clean-up measures detailed in the OSRP.

Certain hazardous materials necessary to support the installation of the WTGs will be transported to and from the SRWF and ports. The transport of this material may result in the accidental discharges of small volumes of hazardous materials, such as oils, solvents, or electrical fluids. If installed, the OCS–DC will have transformers that contain large reservoirs of electrical insulating oil (such as mineral oil), as well as smaller amounts of additional fluids (such as diesel fuel and lubricating oil).

CONSTRUCTION AND OPERATIONS PLAN

Site Characterization and Assessment of Impacts – Impact Producing Factors

Operations and Maintenance

The WTGs and OCS–DC will be designed to contain any potential leakage of fluids, thereby preventing the discharge of fluids into the ocean. The OCS–DC and WTGs will require various oils, fuels, and lubricants to support its operation, as detailed in Table 3.3.6-2 and Table 3.3.8-2. During WTG operations, small accidental leaks could occur because of broken hoses, pipes, or fasteners. During WTG maintenance, small releases could occur during servicing of hydraulic units or gearboxes. Any accidental leaks within the WTGs are expected to be contained within the hub and main bed frame or tower. The only discharges to the sea that are anticipated are those associated with vessels performing maintenance, and from filtered cooling water discharged from the OCS–DC at 40 ft (12 m) below MSL. BMPs for fueling and power equipment servicing greatly minimize the potential for spills and accidental releases. Accidental releases are minimized by containment and clean-up measures detailed in the OSRP (Appendix E1).

4.2.5.2 Sunrise Wind Export Cable

Construction and Decommissioning

Discharges and releases of liquids and solid waste from SRWEC construction and decommissioning are similar to those described above for the SRWF. The cables of the SRWEC do not contain liquid so there is no risk of cable rupture and release. Vessels used during SRWEC construction or decommissioning will also comply with applicable local, state, and federal regulations and Project-specific plans and procedures.

Installation of the SWREC at the landfall will utilize HDD to install the cables under the seafloor, intertidal area, and beach. The use of drilling fluid, which typically consists of a water and bentonite mud mixture or another non-toxic drilling fluid, will be required. Bentonite is a natural clay that is mined from the earth. While these fluids are considered non-toxic, Sunrise Wind will implement BMPs during construction to minimize potential releases of the drilling fluid associated with HDD activities. An Inadvertent Return Plan will also be developed prior to construction to address inadvertent release of drilling fluids.

Operations and Maintenance

As described for the SRWF, during O&M, the only discharges to the sea that are anticipated are those associated with vessels performing maintenance. BMPs for fueling and power equipment servicing greatly minimize the potential for spills and accidental releases. Accidental releases are minimized by containment and clean-up measures detailed in the OSRP (Appendix E1).

4.2.5.3 Onshore Facilities

Construction and Decommissioning

The potential for discharges and releases from construction will be governed by NYS regulations and the Project's EM&CP, including the Project's SPCC. Onshore construction activities will adhere to the SPDES General Permit and the Project's SWPPP.

CONSTRUCTION AND OPERATIONS PLAN

Site Characterization and Assessment of Impacts – Impact Producing Factors

Operations and Maintenance

The OnCS–DC will require various oils, fuels, and lubricants to support its operation (Table 3.3.1-2) but represents low potential for discharges and releases during routine O&M. An SPCC Plan will be developed as part of the Project's EM&CP and any discharges or release will be governed by NYS regulations.

4.2.6 Trash and Debris

As described in Section 4.2.5, a list of anticipated solid and liquid wastes, and disposal methods and locations are presented in Section 3.0. The discharge or disposal of solid debris into offshore waters from OCS structures and vessels is prohibited by BOEM (30 CFR 250.300) and the USCG (MARPOL, Annex V, Pub. L. 100–220 [101 Stat. 1458]). Project activities that could result in the generation of trash and debris are presented in Table 4.2-1 and are further described below. Resources potentially affected by trash and debris are evaluated in the sections identified in Table 4.2-2.

4.2.6.1 Sunrise Wind Farm, Sunrise Wind Export Cable, and Onshore Facilities

Construction and Decommissioning

Solid waste and construction debris will be generated predominantly during construction and decommissioning of the SRWF, SRWEC, and Onshore Facilities. In accordance with applicable federal, state, and local laws, comprehensive measures will be implemented prior to and during construction to avoid, minimize, and mitigate impacts related to trash and debris disposal. Offshore, trash and debris will be contained on vessels and offloaded at port/construction staging areas. Food waste that has been ground and can pass through a 25-mm mesh screen may be disposed according to 33 CFR 151.51-77. All other trash and debris returned to shore will be disposed of or recycled at licensed waste management and/or recycling facilities. Disposal of any solid waste or debris in the water will be prohibited. Good housekeeping practices will be implemented to minimize trash and debris in work areas, both offshore and onshore. These practices will include orderly storage of tools, equipment, and materials, as well as proper waste collection, storage, and disposal to keep work areas clean and minimize potential environmental impacts. With proper waste management procedures, the potential for trash or debris to be inadvertently left overboard or introduced onto an onshore area is unlikely.

Construction of the OnCS–DC will generate approximately 1,500 cubic yards (cy) (1,147 m³) of solid waste. This material will be disposed of in a landfill and/or recycling center.

Operations and Maintenance

During O&M, the generation of trash and debris will be limited. The nominal amounts of trash and debris generated during this phase will be managed in accordance with federal, state, and local laws and materials will be disposed of in a landfill and/or recycling center and will not be disposed of at sea.

CONSTRUCTION AND OPERATIONS PLAN

Site Characterization and Assessment of Impacts – Impact Producing Factors

4.2.7 Traffic (Vessels, Vehicles, Air)

Anticipated traffic will include vessels, onshore vehicles, and helicopters (see Sections 3.3.9.4 and 3.5.5). An overview of anticipated vessel and helicopter usage is provided in Table 3.3.10-3 for construction and Table 3.5.6-1 for O&M. Potential ports are identified in Table 3.3.10-1.

Activities that could result in potential traffic impacts (vessels, vehicles, and aircraft) are presented in Table 4.2-1 and are further described below. Impacts to resources from Project-related traffic are evaluated in the sections identified in Table 4.2-2.

4.2.7.1 Sunrise Wind Farm

Construction and Decommissioning

A temporary increase in traffic will be generated during SRWF construction and decommissioning by vessels and aircraft, and by use of construction vehicles and equipment at ports used to support Project construction and decommissioning. As described in Section 3.3.9.4, various vessels, helicopters, and unmanned aircraft systems may be used.

Project-associated vessel traffic will occur during construction at the SRWF and along routes between the SRWF and the supporting ports. Timing of vessel traffic will be clarified once final construction schedules are issued and approved. The amount of time that vessels will transit back and forth to the SRWF and how long they will remain on station is greatly dependent on final design factors, weather, sea conditions, and other natural factors. The larger installation vessels (e.g., jack-up installation vessels and DP cable-laying vessels) will generally travel to and out of the construction area at the beginning and end of the SRWF construction and not on a regular basis. Vessels transporting construction equipment and materials (e.g., tugs and feeder barges) will make more frequent trips while smaller support vessels carrying supplies and crew (e.g., CTVs) may travel to the SRWF daily. However, construction crews responsible for assembling the WTGs will hotel onboard installation vessels at sea, thus limiting the number of crew vessel transits expected during installation of the SRWF. There will be a minimum safety perimeter around installation vessels and locations where the SRWF components are being installed. This temporary restricted area will consist of a maximum 500-yard (457-m) safety zone.

It is expected that the majority of the SRWF components will be transported by sea; however, some components and equipment will arrive by land at varying frequencies throughout the construction period. Vehicular traffic during SRWF construction will include truck and automobile traffic over existing roads and highways proximate to ports. Project-related deliveries will result in loading and unloading traffic as well as vehicle movements to complete assembly, fabrication, and staging of SRWF components and equipment.

Sunrise Wind plans to develop a Maintenance and Protection of Traffic Plan (MPTP) within the Project's EM&CP that describes measures to minimize and mitigate for potential impacts to land transportation to the maximum extent practicable during construction, and describes the commitment to continued consultation with stakeholders regarding traffic and transportation management before and throughout construction.

CONSTRUCTION AND OPERATIONS PLAN

Site Characterization and Assessment of Impacts – Impact Producing Factors

Operations and Maintenance

Sunrise Wind expects to use a variety of vessels to support O&M, including SOVs with deployable work boats (SOV support craft), CTVs, jack-up vessels, and cable laying vessels. Helicopters and unmanned aircraft systems may also be used to support O&M of the SRWF.

During O&M, vessel traffic will be limited to routine maintenance visits and nonroutine maintenance, as needed. Limited crew and supply runs using smaller support vessels will be required. Vessel traffic during O&M will be lower than during construction, due to fewer operating vessels.

In support of the assessment of the Project's potential effects on marine transportation and navigation, an NSRA was conducted and is provided in Appendix X. Safety or exclusion zones are not anticipated during operation of the SRWF; therefore, vessels will be free to navigate within, or close to, the SRWF. Sunrise Wind has committed to an indicative layout scenario with WTGs and the OCS–DC sited in a uniform east-west/north-south grid with 1.15 by 1.15-mi (1 by 1-nm; 1.85 by 1.85-km) spacing. This design is a navigation measure itself and provides enough room for most vessels to transit through and safely maneuver within the SRWF. Project vessels will also comply with general rules and regulations and follow the International Regulations for Preventing Collisions at Sea (COLREGs) during both active working activities and transit activities. COLREGS Rule 5 states “at all times maintain a proper lookout by sight and hearing as well as by all available means appropriate in the prevailing circumstances and conditions so as to make a full appraisal of the situation and risk of collision.”

4.2.7.2 Sunrise Wind Export Cable

Construction and Decommissioning

Traffic will be generated during SRWEC construction and decommissioning by vessels and aircraft. The traffic generated will be similar to described above for the SRWF.

Construction of the SRWEC will require various vessel types including tugs, barges, and work and transport vessels. DP vessels will generally be used for cable burial activities. If anchoring (or a pull ahead anchor) is necessary during cable installation, it will occur within the survey corridor (see Section 3.3.9.4 for additional information on vessel anchoring). As described for the SRWF, there will be a minimum safety perimeter around SRWEC installation vessels; this temporary restricted area will consist of a maximum 500-yard (457-m) safety zone.

Aircraft traffic will be similar to that described for the SRWF.

Operations and Maintenance

During O&M, vessel traffic will be limited to routine maintenance visits and nonroutine maintenance, as needed. Limited crew and supply runs using smaller support vessels will be required. Vessel traffic during O&M will be lower than during construction, due to fewer operating vessels. Helicopters and unmanned aircraft systems may also be used to support O&M of the SRWEC, as described in Section 3.5.5.

CONSTRUCTION AND OPERATIONS PLAN

Site Characterization and Assessment of Impacts – Impact Producing Factors

4.2.7.3 Onshore Facilities

Construction and Decommissioning

Vessel and aircraft will not be utilized for onshore activities.

Construction of Onshore Facilities will require construction vehicles, resulting in temporary increases in traffic within the Town of Brookhaven, NY, including the area around Smith Point County Park. Vehicular traffic associated with construction activities will include heavy equipment (e.g., excavators, cranes, dump trucks, and paving equipment). Onshore construction activities will comply with local ordinances to the extent practicable; some activities, such as HDD, may require construction timeframes that extend beyond standard work hours, or may require 24-hour operations. The increase in construction traffic would be comparable to typical roadway or utility construction work. NYS Law requires that the Onshore Transmission Cable and Onshore Interconnection Cable be constructed in compliance with a detailed plan that includes traffic and other control measures.

During onshore construction, Sunrise Wind will use commercially-reasonable efforts to maintain at least one travel lane of traffic in the section(s) of the road(s) in which construction crews are working; however, during certain periods of work, temporary road closures may be necessary. To allow for traffic to move safely, traffic control measures, such as signage and traffic flaggers, will be used wherever necessary. Traffic control measures to address traffic flow in and around construction areas will be developed as part of the MPTP. All construction-related impacts to roadways will be restored to pre-construction conditions in accordance with *NYSDOT Standard Specifications for Construction and Materials* and in coordination with local entities.

Operations and Maintenance

During O&M, vehicle traffic will be limited to the anticipated use of a pickup truck making routine visits to the OnCS–DC. During occasional maintenance and operational emergency visits, bucket trucks, cranes, and similar vehicles may be needed to facilitate these activities. These limited additional trips are not expected to contribute to local traffic in any way.

4.2.8 Air Emissions

Air emissions associated with construction, O&M, and decommissioning of the Project depend on many factors such as location, scope, type and capacity of equipment, and schedule. Primary emission sources associated with the Project will be from engine exhaust of vessel traffic, heavy equipment, and onshore vehicles during construction (Section 3.3). In general, most criteria pollutant emissions will be from internal combustion engines burning diesel fuel and will include primarily nitrogen oxides (NO_x) and carbon monoxide (CO); a lesser amount of particulate matter (PM) less than 10 micrometers in aerodynamic diameter (PM₁₀), mostly in the form of particulate matter less than 2.5 micrometers in aerodynamic diameter (PM_{2.5}); and negligible amounts of sulfur oxides. Although not a criteria pollutant itself, volatile organic compounds (VOCs) can react in the atmosphere to form ozone (O₃) and will be emitted in relatively low amounts. Project air emissions are subject to the regulations summarized in Section 1.4.

CONSTRUCTION AND OPERATIONS PLAN

Site Characterization and Assessment of Impacts – Impact Producing Factors

Project activities that could result in air emissions are presented in Table 4.2-1 and are further described below. An inventory of Project-related air emissions is provided as Appendix K – *Air Quality Emissions Calculations and Methodology*, under confidential cover. Impacts to resources from air emissions are evaluated in the sections identified in Table 4.2-2.

4.2.8.1 Sunrise Wind Farm

Construction and Decommissioning

Potential impacts to air quality during construction of the SRWF will result from the use of vessels, vehicles, helicopters, and electric generators. It is expected that most, or all, of these vessels will utilize diesel engines burning low-sulfur fuel. Vehicles operating on roads will comply with federal emission control standards and anti-idling laws.

Emissions from decommissioning are expected to be less than construction emissions. Although similar construction activities will occur to decommission the Project components, the activity will be of a shorter duration and decommissioning activities would occur at least 25 years in the future when combustion energy and pollution control technologies will be improved.

Operations and Maintenance

O&M activities for the SRWF will generally consist of SOVs, CTVs, and helicopters for transporting technicians. An emergency diesel generator system will support necessary equipment in case of a power outage at the OCS–DC. Less frequently, a WTG installation vessel and cable laying vessel may be used to service these components during the operational life of the Project (25 to 35 years).

4.2.8.2 Sunrise Wind Export Cable

Construction and Decommissioning

Air emission sources during SRWEC construction will include the vessels that will perform, or support, laying of the SRWEC and HDD installation at the landfall. Most, or all, of these vessels will utilize diesel engines burning low-sulfur fuel. Emissions from decommissioning are expected to be similar to, or less than, construction emissions.

Operations and Maintenance

Air emissions will be associated with O&M activities for the SRWEC, generally consisting of SOVs, CTVs, and helicopters for transporting technicians.

CONSTRUCTION AND OPERATIONS PLAN

Site Characterization and Assessment of Impacts – Impact Producing Factors

4.2.8.3 Onshore Facilities

Construction and Decommissioning

Air emission sources during construction and decommissioning of Onshore Facilities will include on-road and non-road equipment emissions related to construction of the OnCS–DC, HDD, open cut trenching, and cable pulling in addition to several construction vehicles. With the exception of few on-road vehicles burning gasoline, it is expected that most of the on-road and all of the non-road construction equipment will utilize diesel engines burning low-sulfur fuel. Fugitive dust created by construction vehicles will occur during onshore construction and decommissioning activities; these emissions will be controlled through the implementation of a dust control plan.

Operations and Maintenance

Air emissions will be associated with O&M activities for the Onshore Facilities generally including on-road vehicles used by staff traveling to and from the Onshore Facilities.

4.2.9 Visible Infrastructure

Project components that will be permanently visible and occupy space underwater, above water, and on land have the potential to impact resources. Vessels, vehicles, and equipment used during SRWF and SRWEC construction will be visible for a limited time and only from certain offshore locations and onshore areas in the vicinity of construction activities. The temporary nature of these sources during construction have such a negligible anticipated impact on resources that they are not considered further in this discussion. Once the Project is constructed, the visible structures will be the WTGs, OCS–DC, and the OnCS–DC.

Impacts to visual resources and viewsheds are summarized in Section 4.5, Visual Resources, and specifically evaluated in Appendix Q1 – *Offshore Visual Impacts Assessment* and Appendix Q2 – *Onshore Visual Resources Assessment*.

Impacts to marine navigation from visible infrastructure are summarized in Section 4.8, Transportation and Navigation, and specifically evaluated in the Appendix X – *Navigation Safety Risk Assessment* and the impacts to air traffic from visible infrastructure are evaluated in the Appendix Y1 – *Obstruction Evaluation and Airspace Analysis / Radar and Navigational Aid Screening Study*.

Resources potentially impacted by visible structures are identified in Table 4.2-1 and are further described below. Impacts to resources from visible infrastructure are evaluated in the sections identified in Table 4.2-2.

CONSTRUCTION AND OPERATIONS PLAN

Site Characterization and Assessment of Impacts – Impact Producing Factors

4.2.9.1 Sunrise Wind Farm

Construction and Decommissioning

Construction of the SRWF will include visible infrastructure located offshore. Construction will introduce large installation vessels, increased vessel and air traffic, and the installation of large turbine components along the visible horizon and will often be visible from onshore vantage points. The presence of construction vessels along with the WTGs and installation of the OCS–DC in varying stages of construction are likely to introduce discordant visual features on the horizon. However, the visibility will be temporary in nature and at times, will be obscured from view due to atmospheric conditions or curvature of the Earth.

Upon decommissioning, the WTGs and OCS–DC will no longer be visible as they will be disassembled and removed from the area.

Operations and Maintenance

During O&M, the WTGs and OCS–DC will occupy space in the ocean and above the water's surface. Foundations will provide habitat that may be different from the existing seafloor and that extends the length of the water column. The specifications for the WTGs and OCS–DC are discussed in Section 3.3.5.

The WTGs and the OCS–DC will be visible from points on land and water and the degree of visibility is dependent on a range of physical factors including elevation, weather conditions, sea state, and visual obstructions. Visual quality and significance of impact depends on the existing visual landscape and viewer groups, as discussed in Section 4.5 and associated appendices.

4.2.9.2 Sunrise Wind Export Cable

Construction and Decommissioning

As described above for the SRWF, construction will introduce large installation vessels and increased vessel and air traffic along the visible horizon and will often be visible from onshore vantage points. The presence of construction vessels at varying stages of SRWEC construction are likely to introduce discordant visual features on the horizon. However, the visibility will be temporary in nature and at times, will be obscured from view due to atmospheric conditions or curvature of the Earth.

Operations and Maintenance

During O&M, the SWREC will be buried below the seafloor and will not be visible.

CONSTRUCTION AND OPERATIONS PLAN

Site Characterization and Assessment of Impacts – Impact Producing Factors

4.2.9.3 Onshore Facilities

Construction and Decommissioning

Construction activity will result in some visible site disturbance, such as tree clearing, grading, and facility installation. The Onshore Transmission Cable and Onshore Interconnection Cable are largely sited within existing paved ROWs. The site of the OnCS–DC is bound by existing commercial and industrial development. Screening will be implemented at the OnCS–DC to the extent feasible to reduce potential visibility. The potential visibility of Onshore Facilities is evaluated in Appendix Q2.

If the OnCS–DC is removed when the Project is decommissioned, the visual effect of the structure will cease.

Operations and Maintenance

A lidar viewshed analysis was completed to determine the areas within the 3-mi (2.6-nm, 4.8-km) OnCS–DC Visual Study Area (VSA) that may have visibility of the OnCS–DC. Results of this analysis suggested that approximately 2 percent of the 3-mi (2.6-nm, 4.8-km) VSA would have visibility of some portion of the OnCS–DC. Where visible, it is expected that views of the OnCS–DC from most areas would be limited to the uppermost portions of the proposed lightning masts, which have narrow, slender profiles and do not generally attract viewer attention, particularly when viewed amongst foreground to background mature vegetation.

4.2.10 Lighting and Marking

The impacts of lighting depend on the lighting source and factors that can affect light transmission, both in air and water. In air, the transmission of light can be affected by atmospheric moisture levels, cloud cover, and type and orientation of lights. In water, the transmission of light can be affected by turbidity levels and waves. Project activities that could result in potential impacts from lighting and marking are identified in Table 4.2-1 and are further described below. Impacts to resources from lighting and marking are evaluated in the sections identified in Table 4.2-2.

4.2.10.1 Sunrise Wind Farm

Construction and Decommissioning

There will be a temporary increase in the amount of lighting during construction and decommissioning due to the presence of work vessels and structures that are being installed. In general, lights will be required on the OCS–DC, vessels, and construction equipment during construction and decommissioning of the SRWF. In addition, temporary work lighting will illuminate work areas on vessel decks or service platforms of adjacent WTGs and the OCS–DC during nighttime construction. During Project construction, operating vessels will follow USCG lighting and marking requirements, and as structures are installed, they will be lit and marked according to BOEM and USCG guidelines. Upon decommissioning, all operational lighting, as described further below, will be removed.

CONSTRUCTION AND OPERATIONS PLAN

Site Characterization and Assessment of Impacts – Impact Producing Factors

Operations and Maintenance

During operations, offshore structures will require lighting that conforms to FAA and BOEM guidelines, and USCG requirements. BOEM has indicated that offshore lighting should meet standard specifications in FAA Advisory Circulars 70/7460-1L, Change 2 (FAA 2018) and 150/5345-43H (FAA 2016), and USCG standards for marine navigation lighting. FAA navigation marking and lighting recommendations apply to structures that are up to 12 nm (22 km) offshore. The WTGs and OCS-DC are outside of 12 nm (22 km), and under the jurisdiction of both the USCG (out to 200 nm) and BOEM.

Project lighting will follow lighting and marking design parameters, as identified in BOEM's *Guidelines for Lighting and Marking of Structures Supporting Renewable Energy Development* (BOEM 2021). The Project is evaluating the implementation of methods to limit the visual impact of the aviation light, for example light dimming or the use of a radar-based ADLS to turn on, and off, the aviation obstruction lights in response to detection of aircraft. Sunrise Wind will use ADLS or related means (e.g., dimming or shielding) to limit visual impact, pursuant to approval by the FAA and BOEM, commercial and technical feasibility at the time of FDR/FIR approval, and dialogue with stakeholders. The OCS-DC will be lit and marked in accordance with BOEM and USGS requirements for aviation and navigation obstruction lighting, respectively; the specific systems will vary depending on the turbine selected, and will be reviewed by the selected CVA and provided in the FDR.

Offshore turbines must be visible not only to pilots in the air but also to mariners navigating on water. In daylight, offshore wind turbines do not require lighting if the tower and components are painted white. Marine Navigation Lighting is regulated by the USCG through 33 CFR 67 [63]. Structures must be fitted with lights for nighttime periods.

A conceptual lighting scheme was developed in accordance with federal regulations and is included in the NSRA presented as Appendix X.

4.2.10.2 Sunrise Wind Export Cable

Construction and Decommissioning

Similar to SRWF, operating vessels will follow USCG lighting and marking requirements during Project construction and decommissioning of the SRWEC. As such, all vessels operating between dusk and dawn will be required to illuminate appropriate navigation lights.

Operations and Maintenance

Lighting and marking associated with the cable during the O&M will be short term, limited to the lighting and marking required on vessels while operating along the corridor.

4.2.10.3 Onshore Facilities

Construction and Decommissioning

Onshore construction and decommissioning are expected to generally occur during daylight hours, subject to state and local requirements. Some construction activity will occur outside of these times, and lighting will be provided for safety and security purposes.

CONSTRUCTION AND OPERATIONS PLAN

Site Characterization and Assessment of Impacts – Physical Resources

Operations and Maintenance

Due to the presence of an existing electrical substation and industrial uses of the area, new lighting associated with the OnCS–DC is expected to be consistent with the lighting associated with existing uses adjacent to the OnCS–DC. Any potential effects can be reduced through the use of mitigation such as visual screening. Lighting for the OnCS–DC will be designed to the minimum standard necessary for substation safety and security per utility operational requirements, as well as state and local regulations. General yard lighting will be provided within the site for assessment of equipment. In general, yard lighting will be minimal at night and subject to state and local requirements unless there is work in progress on site or lights are required for safety and security purposes.

4.3 Physical Resources

4.3.1 Oceanographic and Meteorological Conditions

This section describes the affected environment and assesses potential effects from the construction and operation of the Project, as they relate to oceanographic and meteorological conditions. It was developed by reviewing current public data sources related to oceanographic and meteorological conditions, including state and federal agency-published papers and databases; online data portals and mapping databases (e.g., NOAA, National Centers for Environmental Information [NCEI]); environmental studies; and published scientific literature. A description of the oceanographic and meteorological conditions in the marine portions of the Project Area is provided below, followed by an evaluation of potential Project-related impacts. The Onshore Facilities portion of the Project is located on land and therefore is not considered part of the affected environment for the oceanographic and meteorological aspects of the Project.

Understanding the oceanographic and meteorological conditions of the Project Area is important for successful Project design, construction, and O&M parameters, and design of the Project will take into account local climatic conditions. The measurement equipment that Sunrise Wind plans to install is described in Section 3.3.9. In accordance with 30 CFR 585.701, Sunrise Wind will complete a detailed metocean analysis in support of the Project's basis of design, which will be submitted with the FDR prior to construction.

4.3.1.1 Affected Environment

This section summarizes the affected environment relative to oceanography and meteorology for the SRWF and SRWEC. The following parameters are specifically discussed: circulation, waves, tidal fluctuations, water column stratification, wind, storms, cyclones, and ice and fog. Since circulation and water column stratification are considered generally comparable between the SRWF and SRWEC portions of the Project, impacts to oceanographic resources in these geographical areas are assessed together in this section, and discussed from a regional standpoint.

CONSTRUCTION AND OPERATIONS PLAN

Site Characterization and Assessment of Impacts – Physical Resources

Sunrise Wind Farm and Sunrise Wind Export Cable

Ocean Circulation

Circulation patterns are influenced by winds, tides, differences in water density (dependent on temperature and salinity), and geomorphology (bathymetry and land masses). Surface currents are affected by winds, and in response, can drive opposing currents lower in the water column. Differences in water densities and temperatures can drive local or regional circulation patterns that can span the whole water column. The Coriolis effect, tides, and larger movements of water, such as the Gulf Stream, drive a net transport of water. Overall, net transport of water in the region moves toward the southwest and west. However, bottom water may flow toward the north, particularly during the winter. Circulation patterns in the area are influenced by the circulation patterns of Block Island Sound, the Gulf of Maine, and the Gulf Stream. Warm core rings that split off from the northward-flowing Gulf Stream could move into SRWF, bringing entrained warm water biota (RI CRMC 2010). Regionally, currents from Rhode Island Sound meet outflow from Block Island Sound off Montauk Point and flow towards the southwest, south of Long Island. Although current flow south of Long Island follows the overall southwestern movement, nearshore currents flow towards the east (RI CRMC 2010).

Waves generally move across this region from the south with average wave heights ranging from 3.3 to 9.8 ft (1 and 3 m). The highest storm waves are up to 30 ft (9 m) high. Under normal conditions, wave action results in little disturbance to bottom waters or sediments. Semi-diurnal (i.e., twice daily) tides flood in from the southeast, with an average tidal amplitude of 3.2 ft (1.0 m) (RI CRMC 2010). Relative sea level rise will also influence the waves, water level, and currents throughout the Project's 25 to 35-year life. Based on data trends recorded at NOAA Station 8510560 in Montauk, New York, relative sea level rise is anticipated to increase by 3.37 mm/year. Over the course of the Project's life cycle, relative sea level rise is anticipated to increase between 84.25 to 117.95 mm (3.3 to 4.6 in).

An assessment of ocean currents and statistics were generated based on modeled hindcast reanalysis of inputs for the years 2001 to 2010 from the Hybrid Coordinate Ocean Model (HYCOM) 1/12-degree global simulation, which references assimilated data through the Navy Coupled Ocean Data Assimilation, developed by the US Naval Research Laboratory (Halliwell 2004). The 2001 to 2010 period was chosen as the most recent 10 years of reanalysis data for HYCOM currents and its matching wind Climate Forecast System Reanalysis (CFSR) that is available. Average surface current speeds were consistently found to be about 8 inches per second (in/s; 20 cm/s) throughout the year, with the strongest currents of 20 in/s (50 cm/s; as the 95th percentile) in late fall and early spring, as depicted in Figure 4.3.1-1.

CONSTRUCTION AND OPERATIONS PLAN

Site Characterization and Assessment of Impacts – Physical Resources

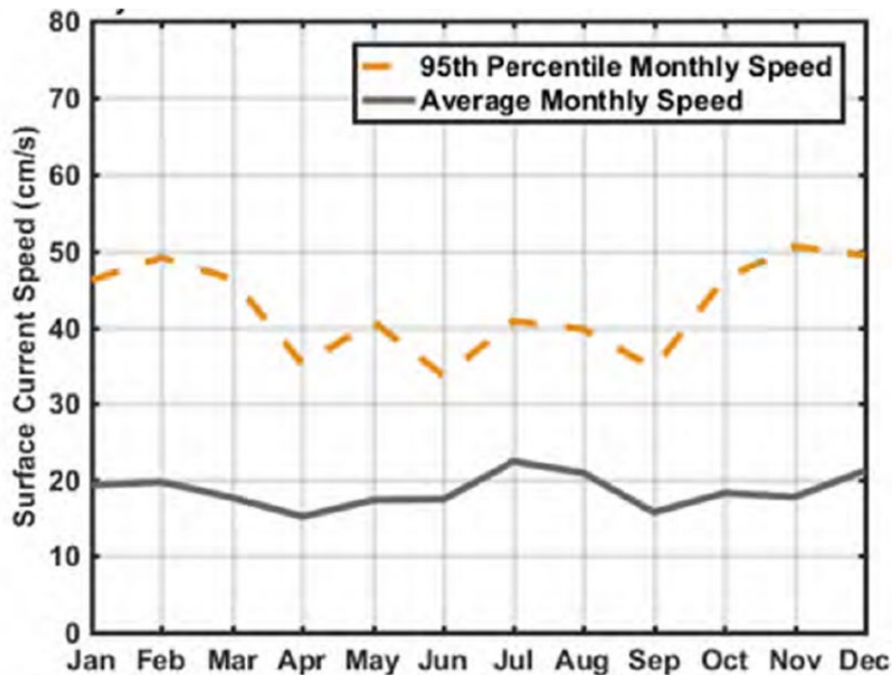

Sources: Halliwell 2004; Chassignet et al 2007

Figure 4.3.1-1 HYCOM Monthly Current Speed Statistics from January 2001 to December 2010

Estimated average currents at a depth of 147.6 ft (45 m) range between approximately 2.6 in/s (6.7 cm/s) as the mean, to 6.1 in/s (15.4 cm/s) as the 95th percentile. Throughout the water column, mean currents generally will show vertical variability, with the strongest currents occurring at the water surface and the weakest currents occurring near the seafloor. Within SRWF, water depths range between approximately 115 and 203 ft (35 and 62 m) MLLW. The magnitude of mean velocities is anticipated to be weaker at depths greater than 148 ft (45 m), while at water depths less than 148 ft (45 m) mean velocities are expected to be larger than those observed at 148 ft (45 m). Currents show directional variability from the surface to the bottom, changing from eastern and western directed surface currents to predominantly western directed currents at depths of 66 and 131 ft (20 and 40 m). Differences between surface and bottom currents can be partially attributed to the influence of wind effect on the surface layer and regional bathymetric features on the bottom, as depicted on Figure 4.3.1-2.

CONSTRUCTION AND OPERATIONS PLAN

Site Characterization and Assessment of Impacts – Physical Resources

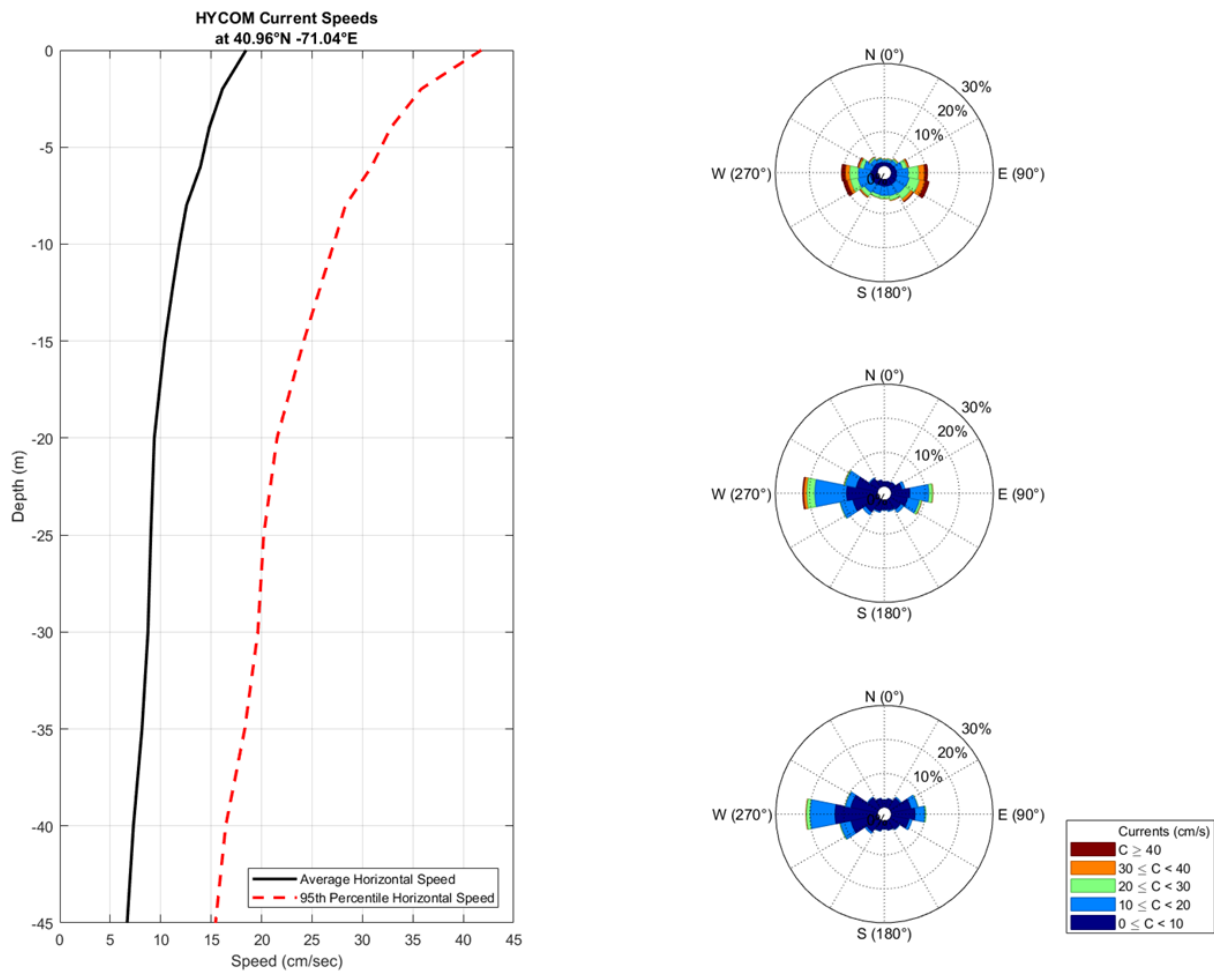

Figure 4.3.1-2 Vertical Profile of the HYCOM 2001-2010 Horizontal Current Speeds Dataset

*Figure depicts the average and 95th percentile current speed and variation with depth near the SRWF. Current roses illustrate speeds from the surface (top right), 20 m (central right) and 40 m (bottom right) depths, and flow direction.

Figure 4.3.1-13 illustrates that surface currents move towards the west from spring into early summer and to the east from late summer into fall. The surface currents occurring in late summer into early fall are greater and more frequent than those in late spring to early summer.

CONSTRUCTION AND OPERATIONS PLAN

Site Characterization and Assessment of Impacts – Physical Resources

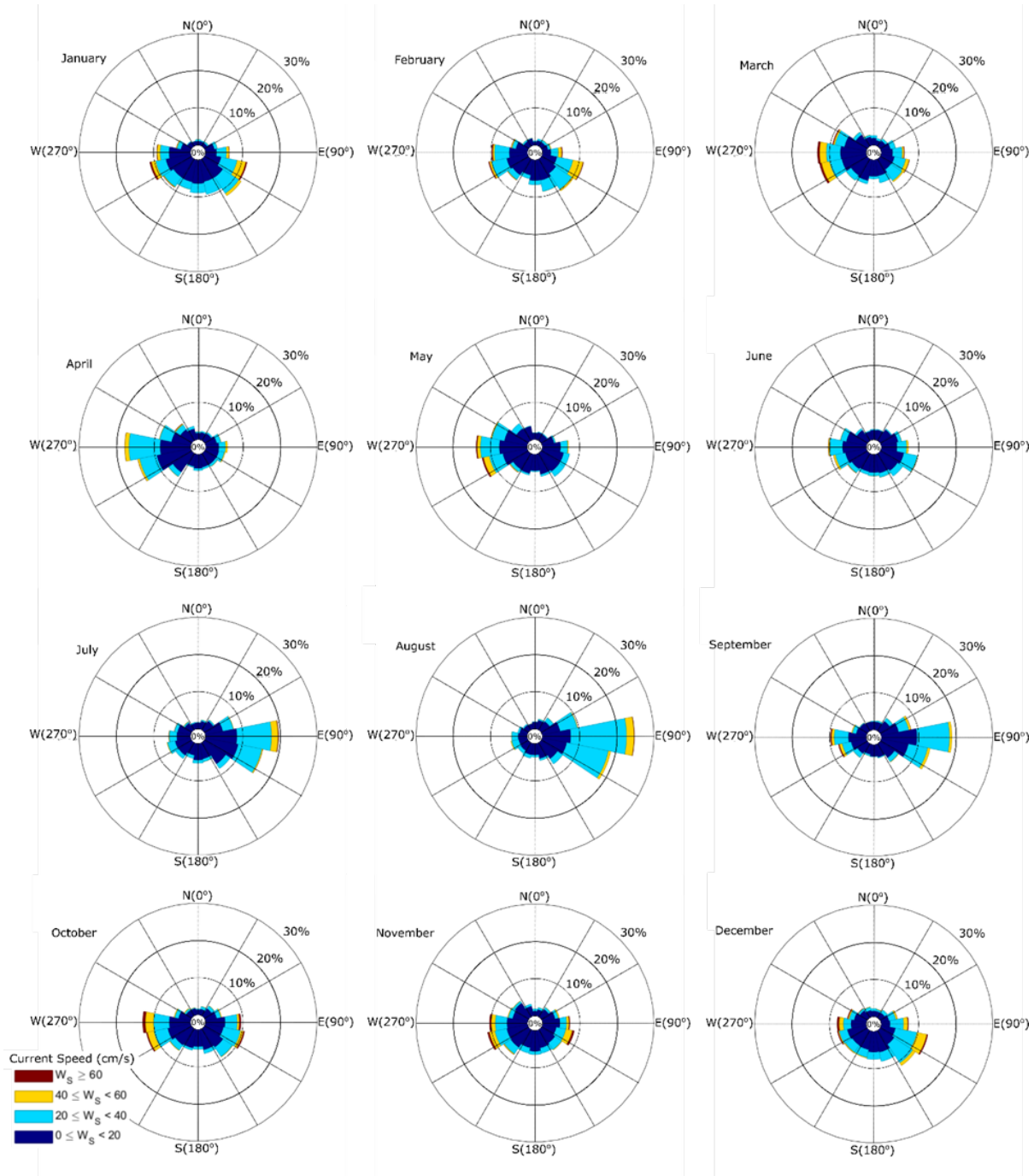

Note: Direction convention is standard (i.e., direction currents are headed).

Figure 4.3.1-3 Monthly Averaged HYCOM Surface Currents near the SRWF from January 2001 to December 2010

CONSTRUCTION AND OPERATIONS PLAN

Site Characterization and Assessment of Impacts – Physical Resources

Surface and bottom currents were evaluated at SRWF, and the surrounding area, using results from the HYCOM model for flood and ebb events on April 6 to 7, 2016. These specific dates were chosen because they occur during a month of high river discharge season and during spring tide. The year 2016 was the most recent timeframe that provided a clean water level signature without the presence of notable non-tidal residuals. Figure 4.3.1-4 and Figure 4.3.1-5 illustrate peak bottom and surface currents, respectively, during a flood event. Maximum currents within the SRWF are approximately 13 in/s (33 cm/s) and 11.4 in/s (29 cm/s) at the surface and bottom, respectively. Similarly, Figure 4.3.1-6 and Figure 4.3.1-7 illustrate peak bottom and surface currents during an ebb event. Maximum currents within the SRWF are 6.9 in/s (17 cm/s) and 5.9 in/s (15 cm/s) at the surface and bottom of the water column, respectively. Based on this assessment of currents, it appears that the SRWF may be located outside the zone of regional southwestward surface current flow from Block Island Sound and Rhode Island Sound.

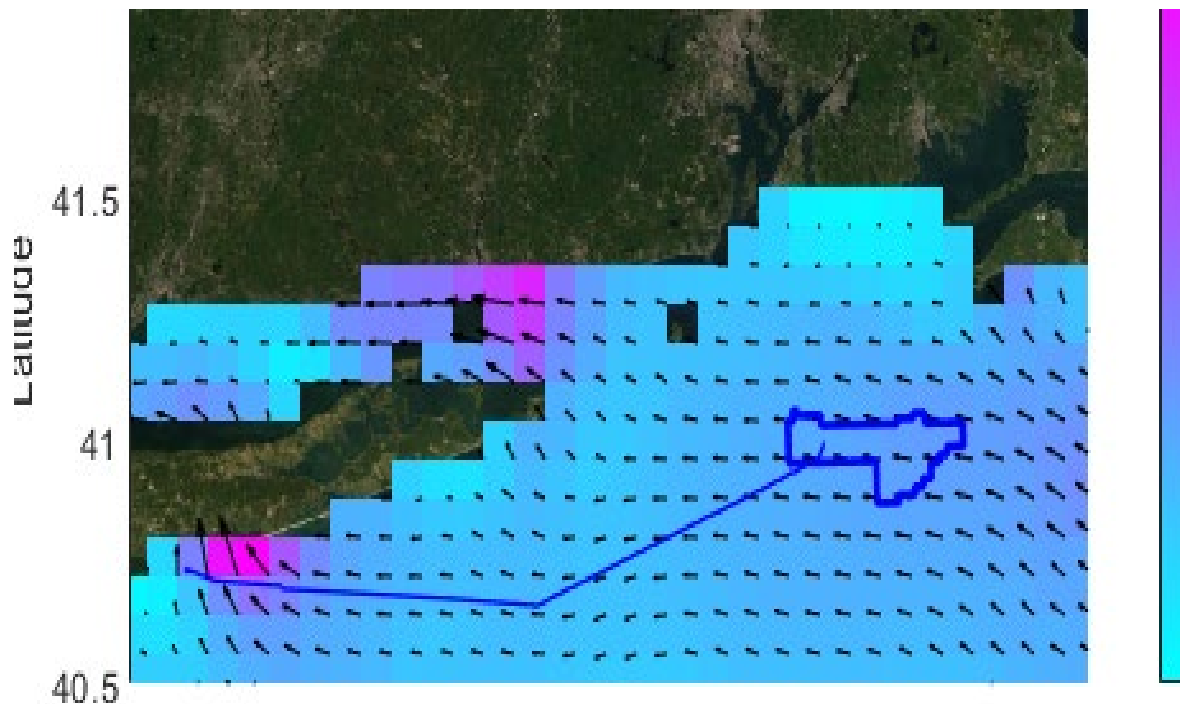

Figure 4.3.1-4 Peak Bottom Currents During a Flood Event on April 6, 2016 at 21:00

CONSTRUCTION AND OPERATIONS PLAN

Site Characterization and Assessment of Impacts – Physical Resources

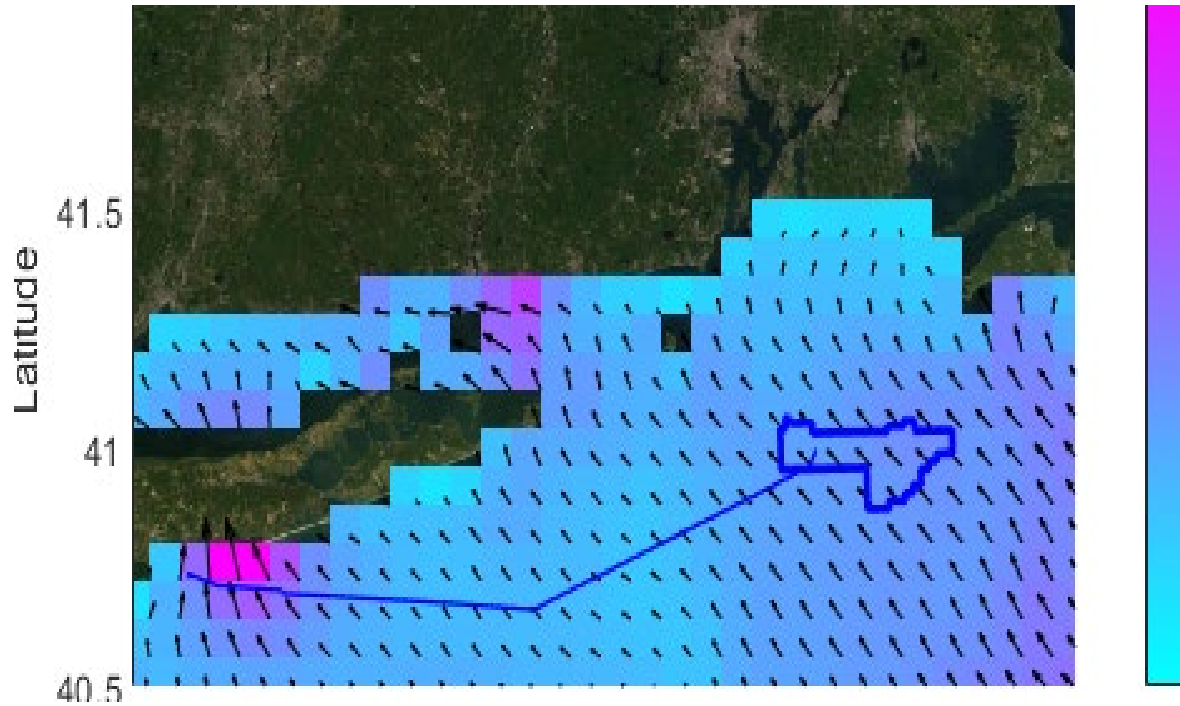

Figure 4.3.1-5 Peak Surface Currents During a Flood Event on April 6, 2016 at 21:00

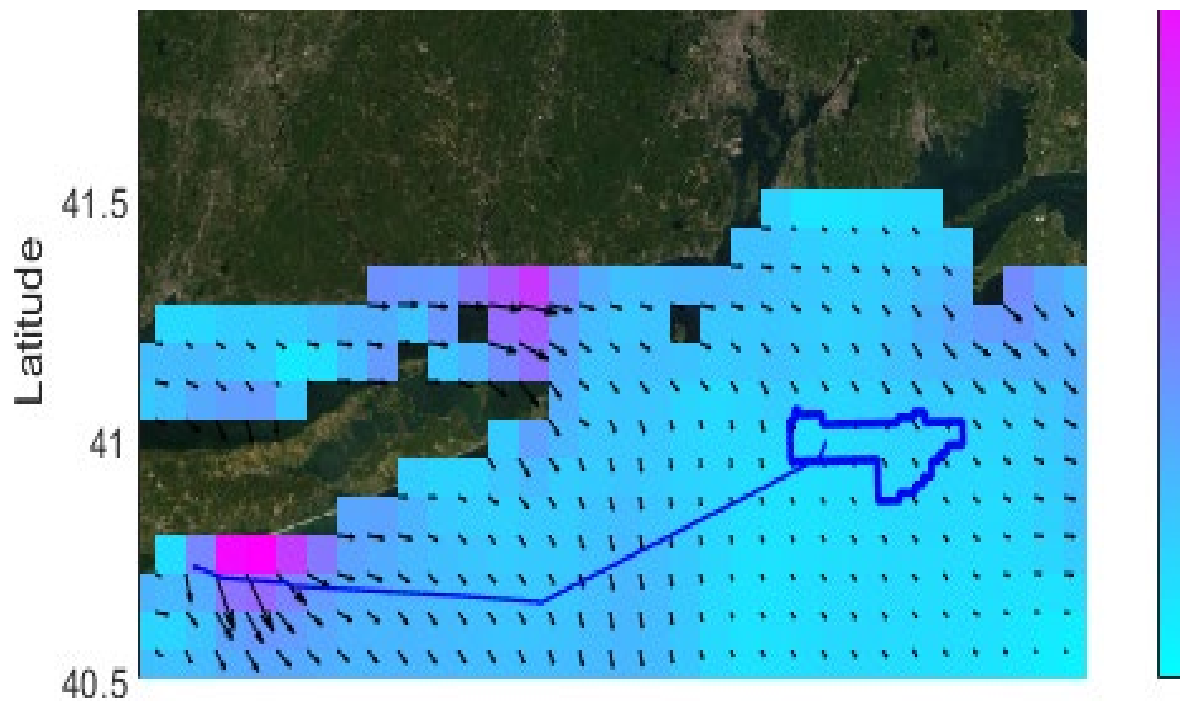

Figure 4.3.1-6 Peak Bottom Currents During an Ebb Event on April 7, 2016 at 03:00

CONSTRUCTION AND OPERATIONS PLAN

Site Characterization and Assessment of Impacts – Physical Resources

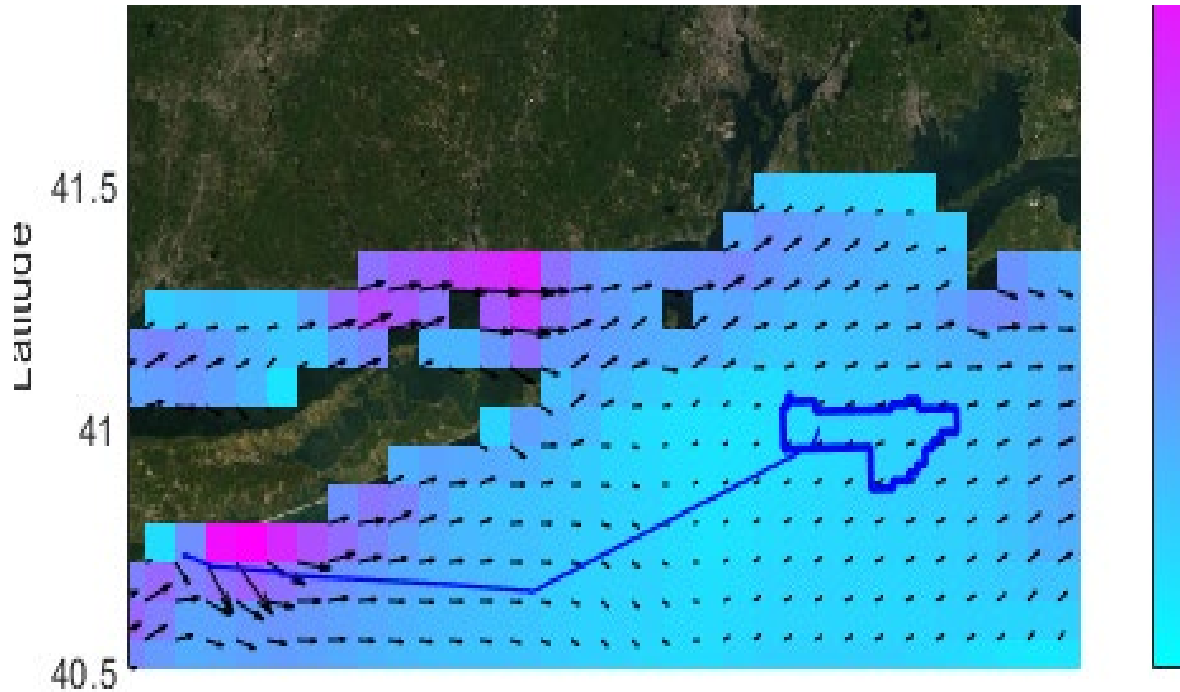

Figure 4.3.1-7 Peak Surface Currents During an Ebb Event on April 7, 2017 at 03:00

Water Column Stratification

In general, the heating of water and increased salinity during late summer and early fall results in a stratified water column that is subject to mixing in the fall from upwelling bottom waters and storm action. The temperature and salinity trends described below contribute to this seasonal stratification. Average seasonal water temperatures from 1980 to 2007 at the surface, 20 m depth, and at the seafloor are depicted in Figure 4.3.1-8 (RI CRMC 2010). Surface water temperatures at the SRWF fluctuate up to 59°F (15°C) seasonally, and as expected, bottom waters at the site have a smaller seasonal variation of approximately 41°F (5°C).

Water temperatures are highest in July and August when the water column becomes stratified; surface water temperatures are near 68°F (20°C), with bottom waters about 50°F (10°C). Stratification can create physical conditions that reduce interactions and mixing between surface waters and the remainder of the water column (RI CRMC 2010). During the winter, average surface water temperatures range from approximately 39 to 41°F (4 to 5°C).

CONSTRUCTION AND OPERATIONS PLAN

Site Characterization and Assessment of Impacts – Physical Resources

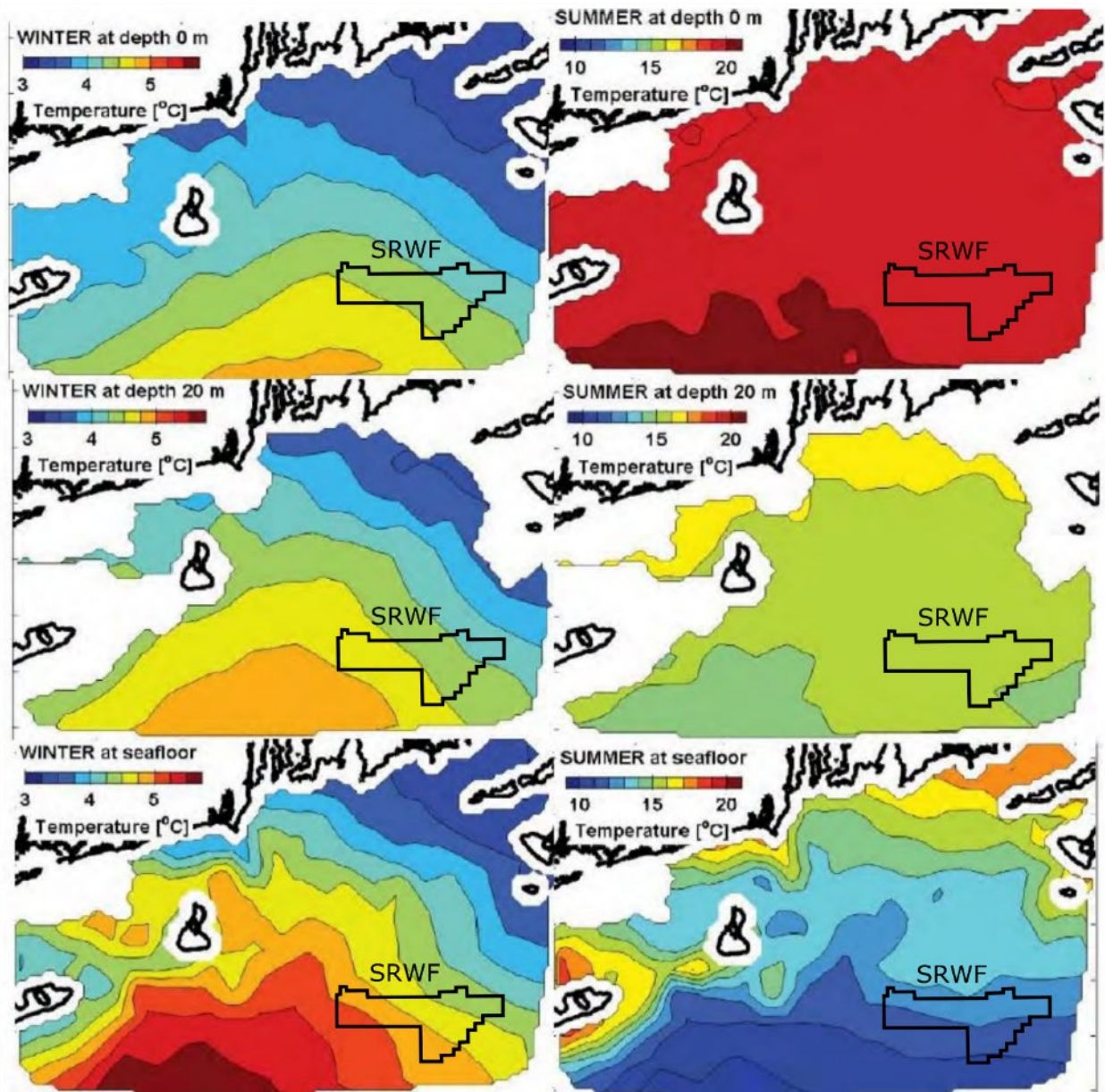

Source: RICRMC, 2010

Figure 4.3.1-8 Seasonal Water Temperature Based on Data Collected Between 1980 and 2007

Surface water salinity decreases in the spring with freshwater inflows from ice melts and spring rains and increases with temperature in the summer, with highest surface water salinities in the fall and winter. Bottom water salinities are higher than surface water salinities throughout the year, setting up for stratification as described above. Highest salinities within the area (approximately 33 Practical Salinity Scale) are found in bottom waters at the southern end of the Rhode Island Sound, near the SRWF. Average seasonal water salinities from 1980 to 2007 at the surface, 65 ft (20 m) depth, and at the seafloor are shown in Figure 4.3.1-9.

CONSTRUCTION AND OPERATIONS PLAN

Site Characterization and Assessment of Impacts – Physical Resources

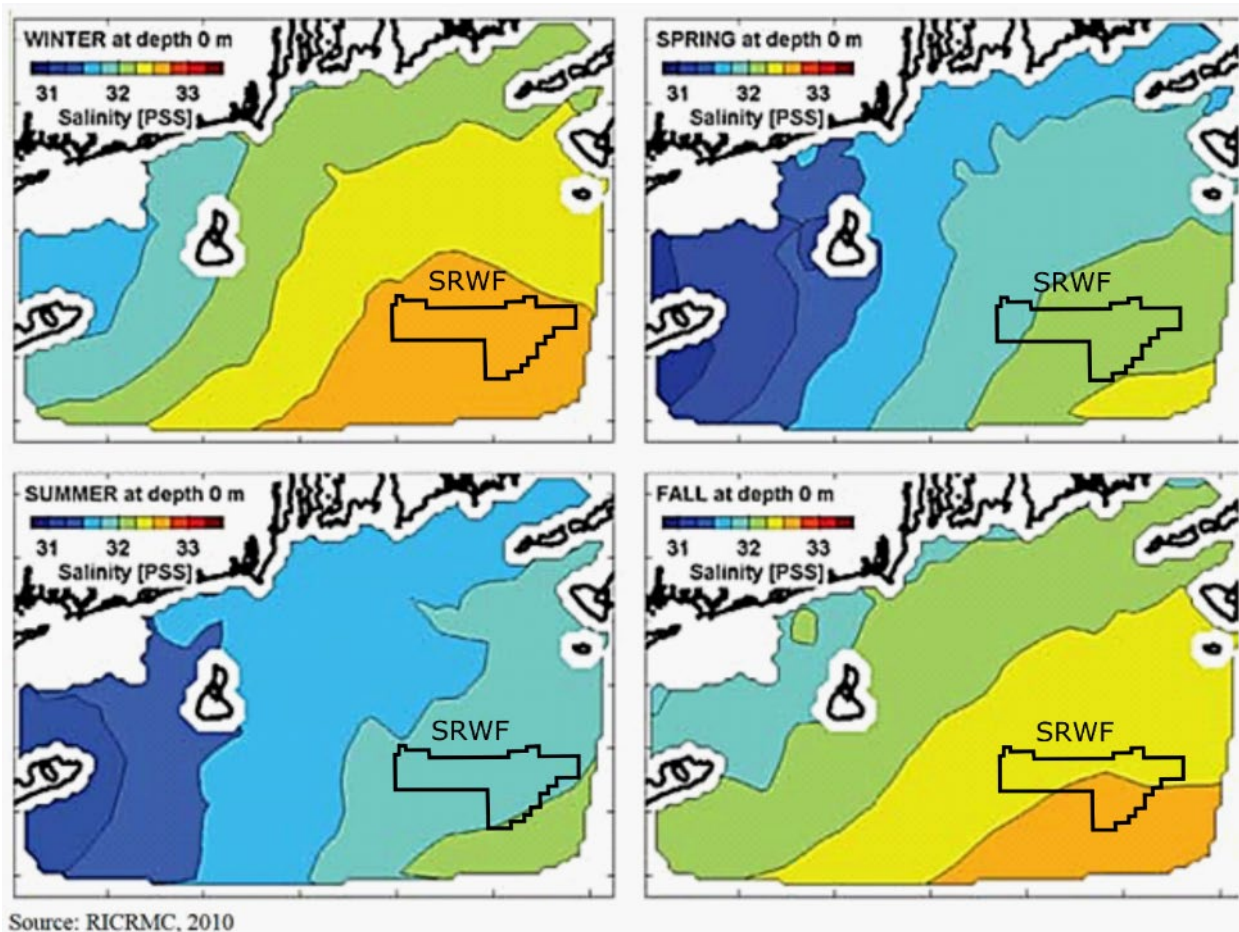

Figure 4.3.1-9 Seasonal Water Salinities at Sea Surface (Depth 0 m) Based on Data Collected Between 1980 and 2007

Wind

Wind in the SRWF influences various physical attributes of the water column and ocean surface, and increased wind speeds that occur later in the summer help break down the water column stratification in the area (RI CRMC 2010). Hourly wind data from 2001 through 2010 were obtained from the National Centers for Environmental Prediction's CFSR model to provide an evaluation of wind direction and speed. Predominant wind direction is from the southwest during the summer months, and from the northwest during the winter. Monthly wind directions and speeds at 33 ft (10 m) above sea level at a representative point within the SRWF are depicted in Figure 4.3.1-10 (Saha et al. 2010).

CONSTRUCTION AND OPERATIONS PLAN

Site Characterization and Assessment of Impacts – Physical Resources

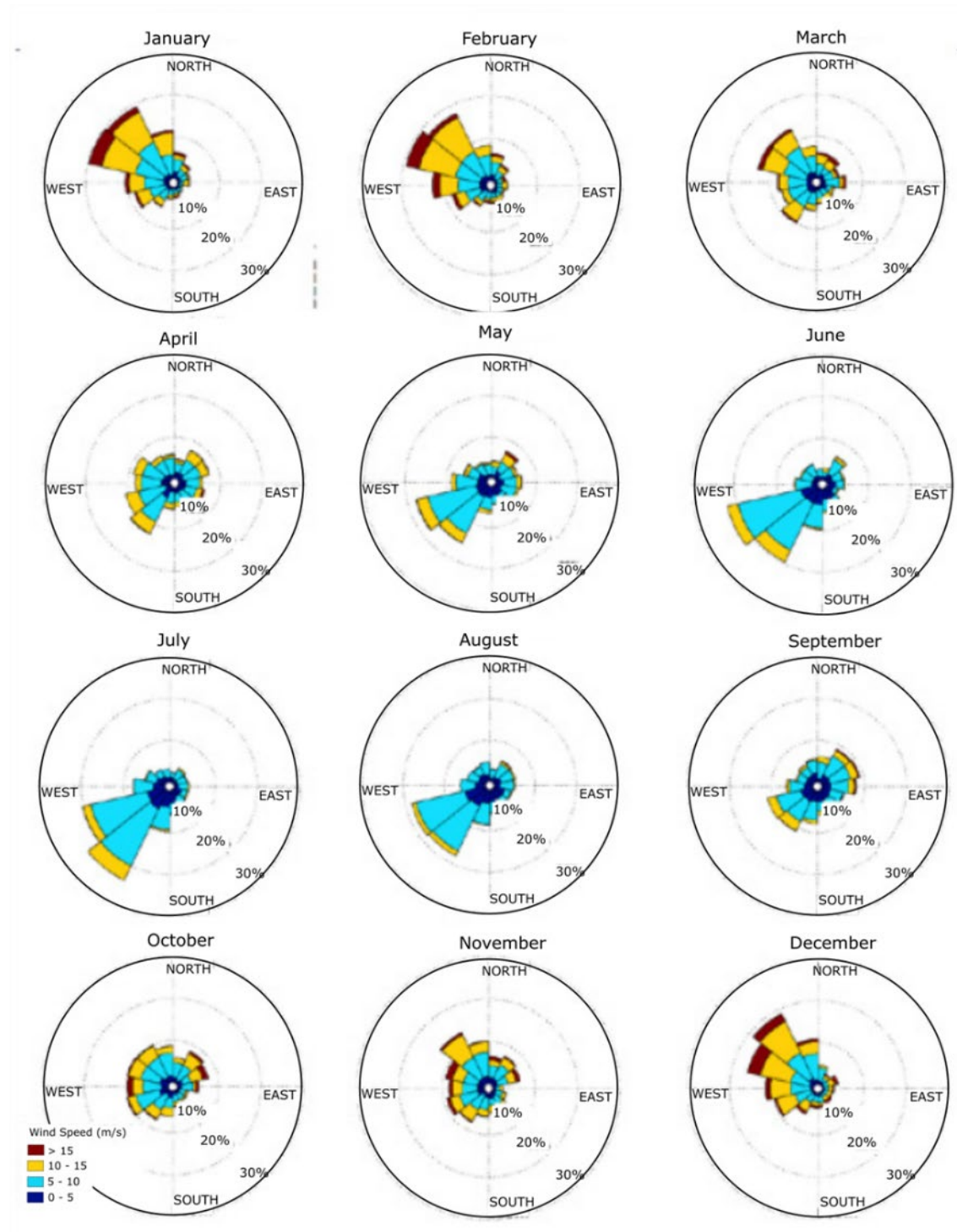

Note: Wind speeds are in m/s using meteorological convention (i.e. direction from which wind is coming)
Source: Saha et al. 2010

Figure 4.3.1-10 Monthly Wind Roses Based on CFSR Model Results from 2001 to 2010

CONSTRUCTION AND OPERATIONS PLAN

Site Characterization and Assessment of Impacts – Physical Resources

Average monthly wind speeds and strongest winds (represented by the 95th percentile) are depicted in Figure 4.3.1-11 for the years 2001 through 2010 (Halliwell 2004; Chassignet et al. 2007). Average wind speeds are between 11 and 22 mph (5 and 10 m/s), with stronger winds observed during winter. The occurrence of stronger winds from the northwest during winter is seen where the 95th percentile curve reaches over 34 mph (15 m/s).

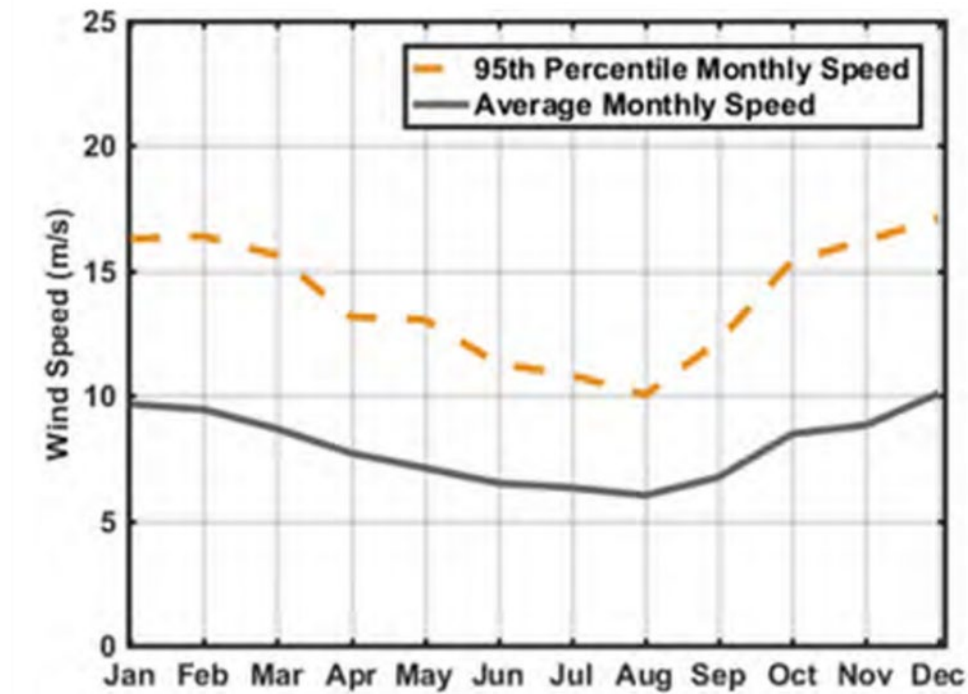

Source: Halliwell 2004; Chassignet et al 2007

Figure 4.3.1-11 CFSR Monthly Wind Speed Statistics Based on Model Results from 2001 to 2010

High wind events, or events where recorded winds meet or exceed 35 knots (18.01 m/s), are recorded at nearby onshore locations by the National Weather Service (NWS) and are then collected, validated, and published by the NOAA NCEI Storm Events Database (NCEI 2019a). Wind observations provided by the Storm Events Database are recorded on a scale of minutes, enabling this data set to capture event peaks. Table 4.3.1-1 is a summary of high wind events, either occurring alone or accompanying a storm event, for Dukes and Nantucket Counties in Massachusetts and the northeast zone of Suffolk County in New York from January 2017 through December 2019. While these data are collected onshore, the counties are proximal to the SRWF and thus the data provide insight to the more extreme conditions that SRWF may experience.

CONSTRUCTION AND OPERATIONS PLAN

Site Characterization and Assessment of Impacts – Physical Resources

Table 4.3.1-1 Recorded High Winds for Dukes and Nantucket Counties, Massachusetts and the Northeast Zone of Suffolk County, New York from January 2017 through December 2019

Date of Measurement	Location (County)	Magnitude (Knots)	Magnitude (m/s)	Measured (MG) or Estimated (EG)
1/23/2017	Suffolk, NY	54	27.78	MG
2/13/2017	Suffolk, NY	58	29.84	MG
3/2/2017	Suffolk, NY	53	27.26	MG
3/14/2017	Dukes, MA	35	18.01	MG
3/14/2017	Nantucket, MA	51	26.24	MG
3/14/2017	Suffolk, NY	59	30.35	MG
3/19/2017	Nantucket, MA	52	26.75	MG
4/1/2017	Nantucket, MA	56	28.81	MG
10/29/2017	Dukes, MA	52	26.75	MG
10/29/2017	Suffolk, NY	65	33.44	MG
10/30/2017	Nantucket, MA	61	31.38	MG
12/25/2017	Dukes, MA	55	28.29	EG
12/25/2017	Nantucket, MA	57	29.32	MG
1/4/2018	Dukes, MA	61	31.38	EG
1/4/2018	Nantucket, MA	57	29.32	EG
3/2/2018	Nantucket, MA	78	40.13	EG
3/2/2018	Dukes, MA	76	39.10	EG
3/2/2018	Suffolk, NY	57	29.32	MG
3/5/2018	Nantucket, MA	35	18.01	MS
3/13/2018	Nantucket, MA	67	34.47	EG
10/27/2018	Nantucket, MA	54	27.78	MG
10/27/2018	Dukes, MA	43	22.12	MG
10/27/2018	Suffolk, NY	56	28.81	MG
11/3/2018	Suffolk, NY	51	26.24	MG
11/16/2018	Nantucket, MA	54	27.78	MG
12/21/2018	Suffolk, NY	56	28.81	MG
1/21/2019	Suffolk, NY	52	26.75	MG
1/24/2019	Suffolk, NY	53	27.26	MG
1/30/2019	Dukes, MA	56	28.81	EG
2/25/2019	Suffolk, NY	60	30.87	MG
9/7/2019	Nantucket, MA	50	25.72	MG
10/10/2019	Nantucket, MA	52	26.75	MG
10/10/2019	Dukes, MA	50	25.72	EG
10/16/2019	Suffolk, NY	56	28.82	MG

CONSTRUCTION AND OPERATIONS PLAN

Site Characterization and Assessment of Impacts – Physical Resources

Date of Measurement	Location (County)	Magnitude (Knots)	Magnitude (m/s)	Measured (MG) or Estimated (EG)
10/17/2019	Nantucket, MA	57	29.32	MG
10/17/2019	Dukes, MA	56	28.81	MG
11/1/2019	Nantucket, MA	53	27.26	MG
11/1/2019	Suffolk, NY	60	30.87	MG
12/2/2019	Nantucket, MA	55	28.29	MG
12/14/2019	Nantucket, MA	54	27.28	MG
SOURCE: NOAA NCEI Storm Events Database (NCEI 2019a)				

Storms

The NOAA NCEI Storm Events Database (NCEI 2019a) was researched for records of severe storm events, including blizzards, hurricanes, tornadoes, tropical depressions, tropical storms, tsunamis, and winter storms within Dukes and Nantucket Counties, Massachusetts and the northeast zone of Suffolk County, New York, from January 2017 through December 2019. A total of 13 events, 6 winter storms, 6 tropical storms, 2 blizzards, and 1 tornado¹⁵ were recorded, some of which correlate with high wind events. While this data is collected onshore, it provides a high-quality continuous record of storms that is not available for nearby offshore instruments. The counties shown are proximal to SRWF and the storms that affect these counties are expected to affect SRWF. See Table 4.3.1-2 for details.

¹⁵ NOAA definitions for storm events are as follows (taken from NOAA 2018):

- Blizzard – a winter storm that produces sustained winds or frequent gusts of 30 knots (35 mph) or greater and falling or blowing snow reducing visibility frequently to less than ¼ mile for a minimum of 3 consecutive hours
- Tornado – a violently rotating column of air extending to or from a cumuliform cloud or underneath a cumuliform cloud to the ground and often, but not always, visible as a condensation funnel. It must be in contact with the ground and extend to/from the cloud base and there should be some semblance of ground-based visual effects such as dust/dirt/rotational markings/swirls, or structural or vegetative damage or disturbance.
- Tropical Storm – a tropical cyclone where the 1-minute sustained surface wind ranges from 34 to 63 knots (39 to 73 mph).
- Winter Storm – a winter weather event that has more than one significant hazard (i.e., heavy snow and blowing snow; snow and ice; snow and sleet; sleet and ice; or snow, sleet, and ice) and meets or exceeds the locally/regionally defined 12 and/or 24-hour warning criteria for at least one of the precipitation elements.

CONSTRUCTION AND OPERATIONS PLAN

Site Characterization and Assessment of Impacts – Physical Resources

Table 4.3.1-2 Recorded Storm Events for Barnstable and Nantucket Counties, Massachusetts and the Northeastern Zone of Suffolk County, New York from January 2017 to December 2019

Date of Measurement	Location (County)	Storm Event
1/7/2017	Nantucket, MA	Winter Storm
1/7/2017	Dukes, MA	Winter Storm
2/9/2017	Suffolk, NY	Winter Storm & Blizzard
2/9/2017	Dukes, MA	Winter Storm
3/10/2017	Nantucket, MA	Winter Storm
3/10/2017	Dukes, MA	Winter Storm
9/20/2017	Dukes, MA	Tropical Storm
9/21/2017	Nantucket, MA	Tropical Storm
1/4/2018	Suffolk, NY	Winter Storm & Blizzard
3/13/2018	Dukes, MA	Blizzard
10/29/2018	Nantucket, MA	Tornado
9/6/2019	Nantucket, MA	Tropical Storm
9/6/2019	Dukes, MA	Tropical Storm

Cyclones

A cyclone is any rotating, organized system of clouds and thunderstorms that originate over tropical or subtropical waters. Tropical depressions (maximum sustained winds 33 knots or lower), tropical storms (maximum sustained winds between 34 and 63 knots), hurricanes (maximum sustained winds 74 knots or higher), and extratropical cyclones (occurring between latitudes of 30 and 60 degrees) are all types of cyclones.

The Project Area is subjected to frequent Nor'easters, which are extratropical cyclones that originate in northern latitudes offshore between Georgia and New Jersey, and typically reach maximum intensity in New England. They primarily occur between September and April but can form any time of the year.

Cyclone tracks are gathered from NOAA National Ocean Service (NOS) Historical Hurricane Tracks maps, which utilize data from the NOAA NCEI International Best Track Archive for Climate Stewardship (IBTrACS) Project (NCEI 2019b) and the Atlantic Hurricane Database (HURDAT2; NCEI 2020). Together these sources contain the most complete global set of historical tropical and extratropical cyclones available, with data available from 1842 to 2019. It combines information from numerous tropical cyclone datasets, simplifying interagency comparisons by providing storm data from multiple sources in one place. As part of the IBTrACS project, the quality of storm inventories, positions, pressures, and wind speeds are checked and information about the quality of the data is passed on to the user. Figure 4.3.1-12 is an illustration of cyclone data near the SRWF, showing the tracks of cyclones having passed within 30 nm of SRWF between 1900 and 2019. The accuracy of wind measurements used to inform hurricane categories in the early 1900s is uncertain and may impact cyclone categorization.

CONSTRUCTION AND OPERATIONS PLAN

Site Characterization and Assessment of Impacts – Physical Resources

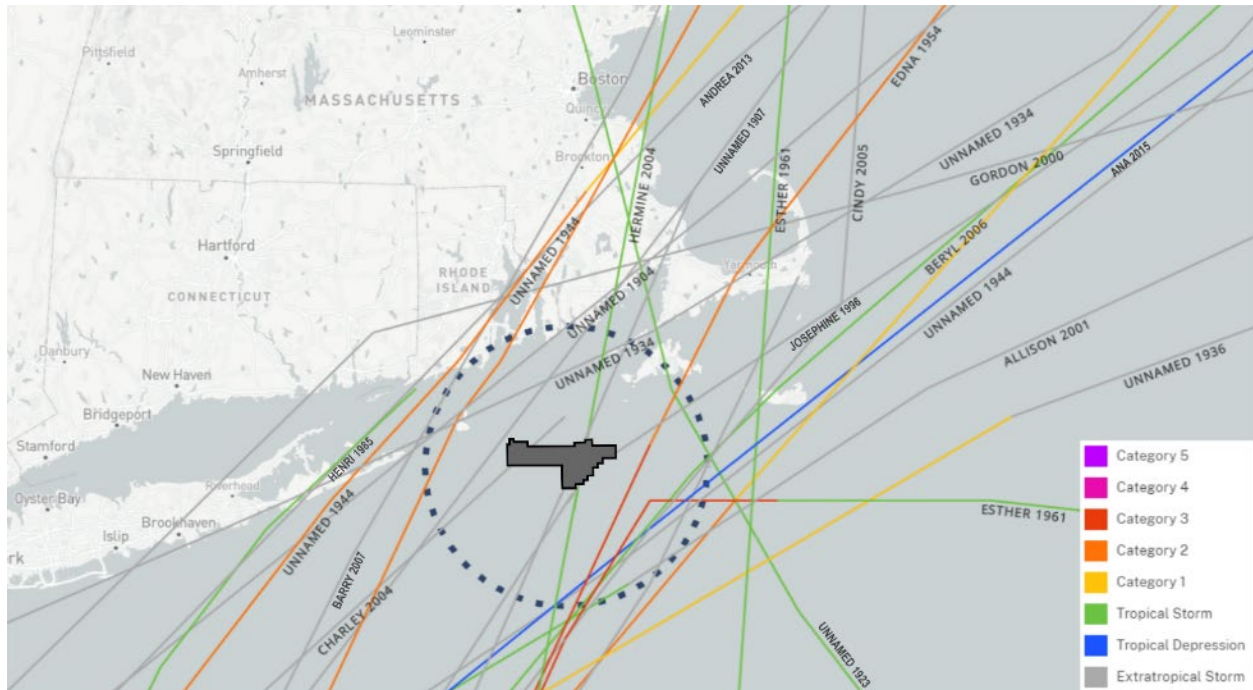

Figure 4.3.1-12 Tracks of Cyclones that Passed Within 30 Nautical Miles of SRWF Between 1900 and 2019

SOURCE: NOAA NOS Historical Hurricane Tracks (NOAA NOS 2020)

Hurricane strike locations recorded between 1900 and 2010 were compiled and presented in hurricane strike density maps by NOAA and the NWS's National Hurricane Center and Central Pacific Hurricane Center. Figure 4.3.1-13 shows the density of hurricane strikes in the Northeastern US by county from the years 1900 to 2010. Counties local to the SRWF show between 5 and 8 strikes over the 110 years of data.

CONSTRUCTION AND OPERATIONS PLAN

Site Characterization and Assessment of Impacts – Physical Resources

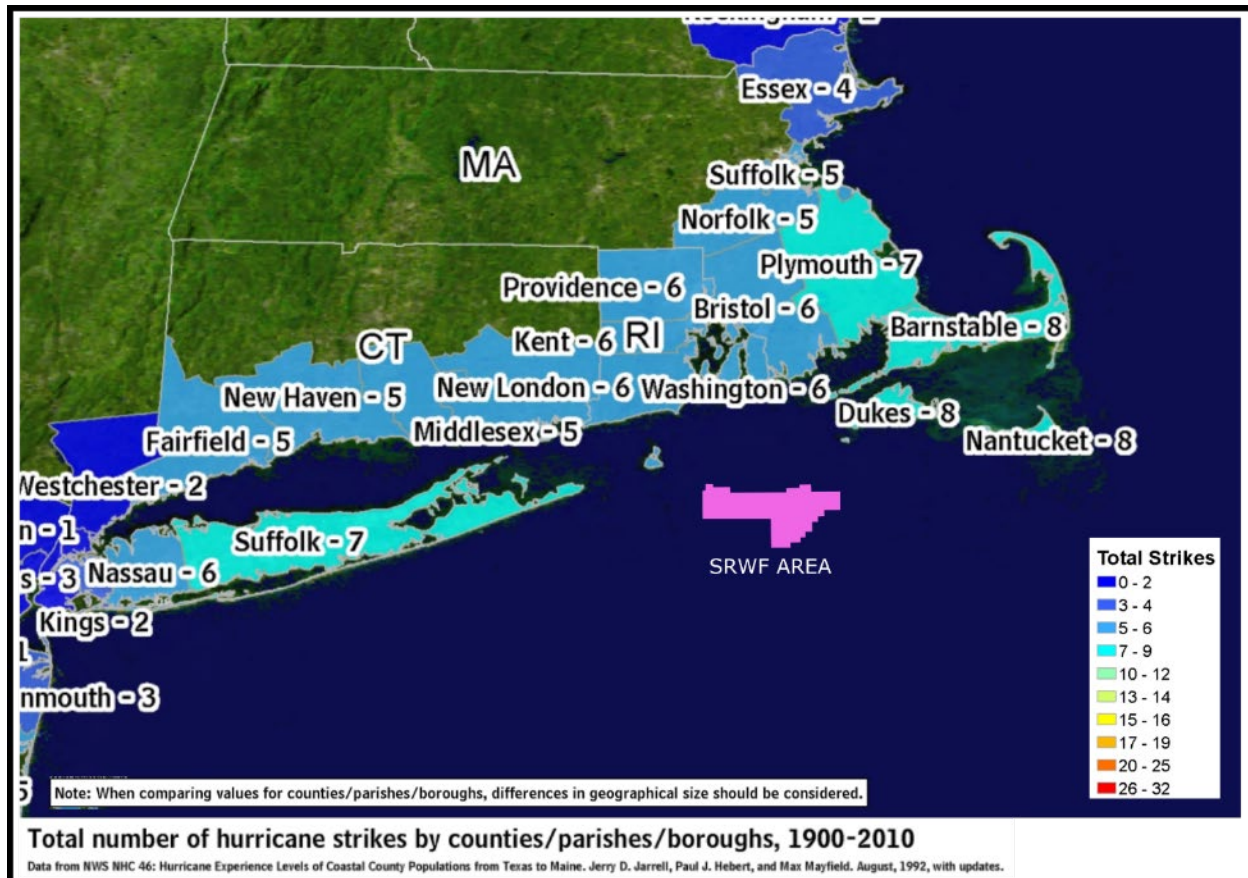

Figure 4.3.1-13 Hurricane Strike Density Map by County from 1900 to 2010

SOURCE: NOAA National Hurricane Center (NOAA 2020)

Available IBTrACS data for all cyclones passing within a certain radius (e.g., 270 nm) of the South Fork Wind Farm were examined and were presented in the South Fork Wind Farm Project Metocean Design Criteria Report (DNV GL 2018). The SRWF is adjacent to the South Fork Wind Farm Project Lease Area and, as such, the IBTrACS data for the South Fork Wind Farm is applicable for the SRWF. For each of those cyclones, the team employed a parametric wind model to identify the maximum wind speed at the South Fork Wind Farm site due to passing cyclones. An extreme value analysis was then performed on the maximum wind speed events resulting from cyclones within the 270-nm radius to determine wind speed values for various return intervals (or frequencies). Several different locations along the cyclone tracks were assessed, and the analysis was applied to those locations with the highest cyclone risk. According to this assessment, a 500-year cyclone would produce wind gusts up to 126 knots (65 m/s) and sustained wind speeds of 109 knots (56 m/s) at 33 ft (10 m) above the sea surface and individual wave heights up to 62 ft (19 m).

CONSTRUCTION AND OPERATIONS PLAN

Site Characterization and Assessment of Impacts – Physical Resources

Ice and Fog

Data collected from NOAA's National Data Buoy Center (NDBC) Station 44017 at Montauk Point, New York, indicates mean air temperatures near the Project range between 1.3°C and 22.4°C (34.3°F and 72.3°F) with minimum and maximum temperatures of -13.8°C and 27°C (7.2°F and 80.6°F) observed during winter and summer months, respectively (Figure 4.3.1-14). Given the cold air temperatures experienced during many New England winters, there is potential for icing of equipment and vessels above the water line during construction and O&M of the Project.

To evaluate the potential for icing and fog conditions within the Rhode Island Ocean Special Area Management Plan (OSAMP), Merrill (2010) assessed data from two locations: Buzzard's Bay Tower (west of the Elizabeth Islands) and Martha's Vineyard Coastal Observatory (1.9 mi [3 km] offshore). Results of the data analysis indicate that the highest potential for fog development is during the summer, with 10 potential days in June compared to 1 to 4 potential days during each of the winter months. Effects of fog on visibility of Project infrastructure are assessed in Section 4.5.1. Days with potential for icing conditions were limited to November through March, with the highest number of days (9) in January.

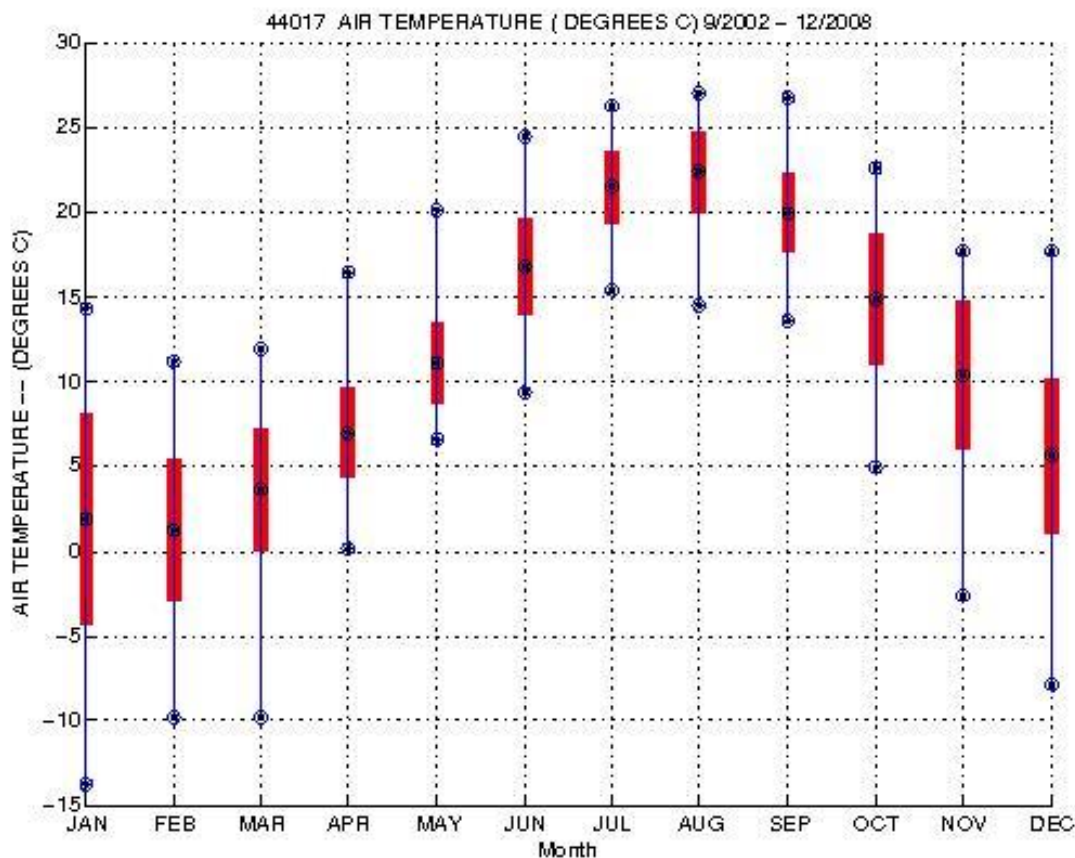

Figure 4.3.1-14 Monthly Mean (center point), Standard Deviation (red bars), Minimum and Maximum (end points) Air Temperatures at NDBC Buoy Station 44017

SOURCE: NOAA National Data Buoy Center (NOAA 2020)

CONSTRUCTION AND OPERATIONS PLAN

Site Characterization and Assessment of Impacts – Physical Resources

4.3.1.2 Potential Impacts

The only IPF that is expected to impact physical oceanographic and meteorological conditions is the physical presence (visible structures) of marine infrastructure associated with the O&M phase of the Project (Figure 4.3.1-15). Construction and decommissioning of the SRWF and SRWEC will involve seafloor disturbance and induce localized sediment suspension and deposition; however, these are not expected to measurably impact oceanographic and meteorological conditions. Similarly, although sediment suspension and deposition are anticipated in association with scour of the SRWF's foundations during O&M, it is not expected that these processes will notably alter oceanographic conditions. The presence of the buried SRWEC will have no influence on meteorological or oceanographic conditions.

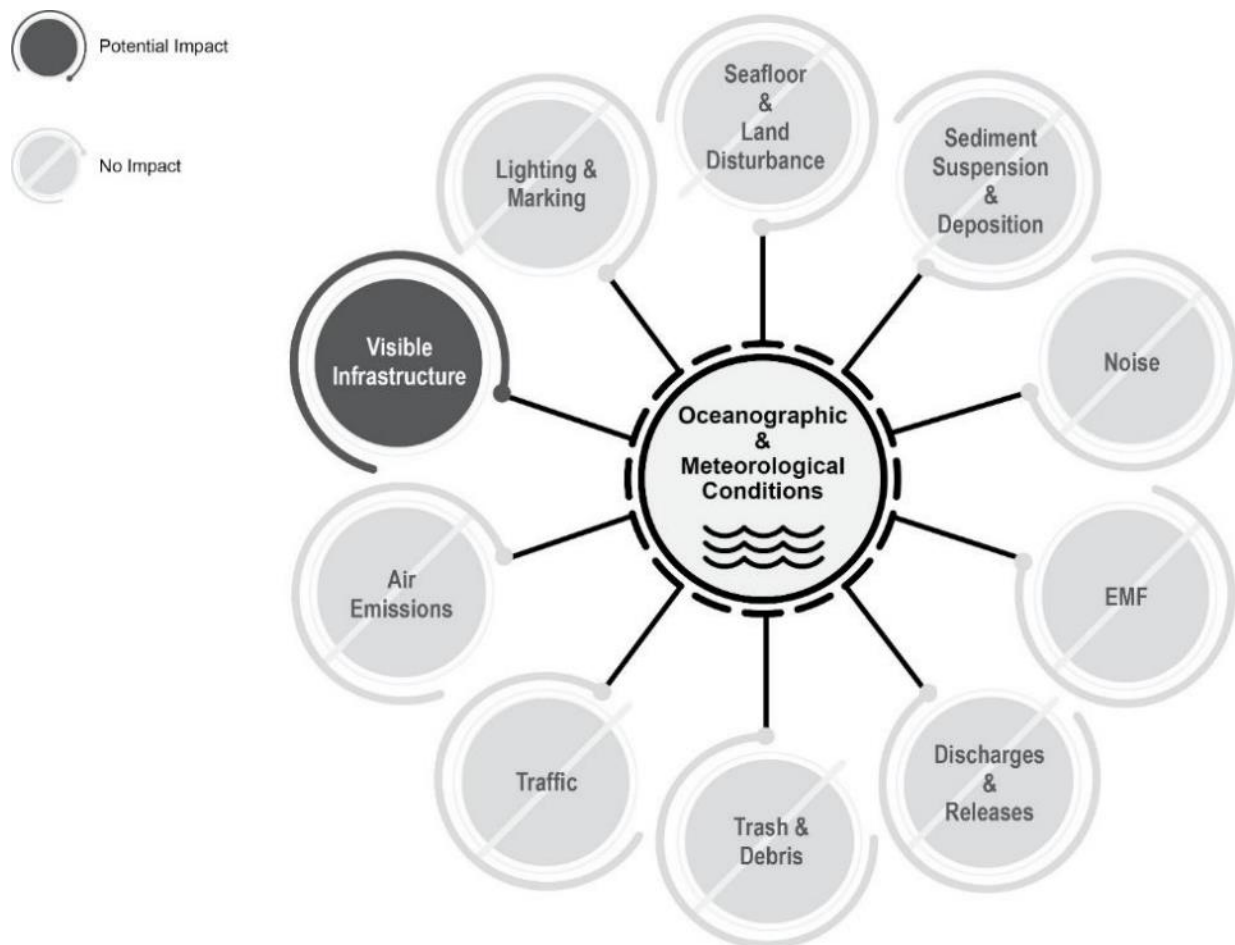

Figure 4.3.1-15 Impact-Producing Factors on Physical Oceanography and Meteorology

Sunrise Wind Farm

Visible structures are expected to have localized, short- to long-term effects to physical oceanographic and meteorological conditions during O&M of the SRWF.

CONSTRUCTION AND OPERATIONS PLAN

Site Characterization and Assessment of Impacts – Physical Resources

Operations and Maintenance

Visible Infrastructure

The presence of SRWF's foundations and WTGs will induce small changes to waves and currents around the structures. Due to the size of the Project footprint and spacing of infrastructure, subtle alterations to ocean currents, circulation, eddy formation, and wave propagation are expected to be limited to the towers of the WTGs. A joint study by BOEM and the University of Massachusetts-Dartmouth's Marine Ecosystem Dynamics Modeling Laboratory investigated the hydrodynamic changes that could be caused by offshore wind foundations. This study found that the wind turbine foundations could locally increase wave heights and bottom stresses (Chen et al. 2016). Wave effects also influence upper ocean changes in the vicinity of offshore wind farms (Paskyabi 2012). The exposed (i.e., above water) portion of the WTGs will also create an obstruction to air flow and cause turbulence within the immediate vicinity of the tower, nacelle, and blades throughout the life of the Project. Corresponding to alterations in wind speeds and flow patterns within the wake of each turbine, wind stresses on the water surface will differ and cause changes in upwelling and downwelling within the vicinity of the structures. Local alternations in upwelling and downwelling affect the water column's temperature variation, sediment transport, biological processes, and mixing within the water column (Broström 2008; Segtnan and Christakos 2015).

BOEM is also funding an additional study to assess how wind energy facilities may affect local and regional physical oceanographic processes, including circulation and sediment, nutrient, and larval transport (BOEM 2020). Additional details on how these effects may influence marine fauna are discussed in Section 4.4.3. Orsted has provided BOEM with ocean current data from several measurement campaigns within its Lease Areas to support the study to help achieve greater modeling accuracy and study reliability.

4.3.1.3 Proposed Environmental Protection Measures

Sunrise Wind has designed the Project to account for site-specific oceanographic and meteorological conditions. Potential impacts to oceanographic and meteorological conditions are considered negligible and, therefore, environmental protection measures are not necessary.

4.3.2 Geological Conditions

This section describes the affected environment and potential effects from the construction and operation of the Project as they relate to geological conditions. The description of the affected environment and assessment of potential impacts to geological conditions were developed by reviewing current public and unpublished data sources, including state and federal agency-published papers and databases; online data portals and mapping databases; environmental studies; published scientific literature relevant to geological conditions; and the Project's G&G surveys. These descriptions provide the basis for an evaluation of potential impacts to geological conditions from the construction and O&M of the Project pursuant to 30 CFR Subpart F. A description of the geological conditions in the Project Area is provided below in Section 4.3.2.1, followed by an evaluation of potential Project-related impacts.

CONSTRUCTION AND OPERATIONS PLAN

Site Characterization and Assessment of Impacts – Physical Resources

With regards to offshore conditions, Sunrise Wind has designed and executed a series of G&G survey campaigns covering the offshore portions of the Project Area to characterize and evaluate geological conditions within the offshore environment, and to provide information in support of the MARs assessment (Section 4.6.1) and benthic and shellfish resources (Section 4.4.2 and Appendix M). All surveys conducted to date have been executed in accordance with BOEM-accepted survey plans and Lease conditions. Results from these survey campaigns are provided in Appendix G1 – *Marine Site Investigation Report*. For the geotechnical survey data being collected in 2021 at each foundation location, Sunrise Wind requested, and was granted on April 26, 2021, a departure from 30 CFR § 585.626(a)(4)(ii) and (iii) to submit these results prior to construction as part of the FDR required under 30 CFR § 585.701.

The results and interpretations of the G&G datasets collected to date have been incorporated into a comprehensive site-specific “ground model.” The ground model is a three-dimensional representation of the geological and stratigraphic conditions within the offshore portions of the Project Area, with a focus on the factors that pertain to Project design and engineering. This ground model contains the best current understanding of the seabed and subsurface conditions and documents the engineering properties within the offshore portions of the Project Area to date. The ground model will be updated continually throughout the life of the Project as new information and more detailed studies and analyses are undertaken and is included as part of Sunrise Wind's MSIR (Appendix G1). The information incorporated into the ground model has and will continue to inform the Project's understanding of geological conditions within the offshore portions of the Project Area and support both facility siting, engineering design, O&M, and decommissioning planning.

Table 4.3.2-1 and Table 4.3.2-2 below summarize the completed, ongoing, and planned in-water geophysical and geotechnical surveys.

CONSTRUCTION AND OPERATIONS PLAN

Site Characterization and Assessment of Impacts – Physical Resources

Table 4.3.2-1 Overview of Completed Geophysical and Geotechnical Surveys

Overview of Completed Geophysical Surveys			
Survey Name	Survey Period	Objective	Contribution to Sunrise Wind Farm Project
Bay State Wind GP1A Site (2016)	August 2016–October 2016	The survey was a reconnaissance survey with a survey grid of 2,953 ft x 2,953 ft (900 m x 900 m). The objective of the survey was to develop a baseline understanding of the seabed and subsurface sediment conditions.	reference only.
Bay State Wind GP1B Site (2017)	January 2018–April 2018	The survey objective was to provide hydrographic and geophysical data and map potential geohazards. Within areas subjected to full coverage the main line spacing was 262 ft (80 m). Outside these areas a line spacing of 1,476 ft (450 m) formed a lattice with cross line spacing of 984 ft (300 m).	Data has been used for reference only.
Bay State Wind GP1B/APE Site (2018)	January 2019–March 2019	The survey objective was to acquire accurate geophysical data of the seabed and the shallow subsurface. The survey area comprised 1,378 ft (420 m) wide corridors covered by 15 lines with 98 ft (30 m) line spacing.	Data have been used to provide coverage for surface classifications/interpretations in parts of SRWF as well as alignment of the ground model.
Sunrise Wind GP1B/APE Site (2019)	August 2019–January 2020 (grab samples)	The main objectives for the survey were to characterize site conditions and identify potential geologic and anthropogenic hazards. Main lines were spaced at 98 ft (30 m) within the three centerlines of the corridor and with 262 ft (80 m) line spacing along the outer sections. Crosslines were spaced at 1,640 ft (500 m). Data from this survey has since been superseded by the Sunrise Wind GP1B/APE ECC (2020) campaign.	
Sunrise Wind GP1A/1B ECC Recon (2019)	August 2019 – November 2019 January 2020 (grab samples)	The survey was a reconnaissance survey that covered the export cable corridor from the Lease Area to NY landfall. Three centerlines were spaced at 98 ft (30 m) and two wing lines with 1,640 ft (500 m) spacing in a 6,562 ft (2,000 m) wide corridor. Crosslines infills were conducted at every 16,404 ft (5,000 m). Data from this survey has since been superseded by the Sunrise Wind GP1B/APE ECC (2020) campaign.	
Sunrise Wind GP1B/APE Infill (2020)	June 2020 – February 2021	The scope of this survey was to provide additional geophysical survey coverage across proposed WTG and OCS–DC positions, as well as along IAC Routes, including the expanded site area to the east. The survey accommodates BOEM guidelines for G&G (BOEM 2020a) and Archaeological (BOEM 2020b) survey to the largest extent possible. The data was acquired using 98 ft (30 m) line spacing with 1,640 ft (500 m) tie lines.	
Sunrise Wind GP1B/APE ECC (2020)	April 2020 – August 2020	Following on from the SRW01 GP1A/1B ECC Recon (2019) survey, this survey was conducted with a full corridor survey of the SRWEC at 98 ft (30 m) line spacing with 500 m tie lines. The survey accommodates BOEM guidelines for G&G (BOEM 2020a) and Archaeological (BOEM 2020b) surveys to the largest extent possible.	
Sunrise Wind GP1B/APE Nearshore (2020)	March 2020 (suspended due to COVID19); Recommended June 2020 – August 2020	This survey covers all survey APE relating to cable corridors in shallow water nearshore. The survey accommodates BOEM guidelines for G&G (BOEM 2020a) and Archaeological (BOEM 2020b) surveys to the largest extent possible Especially in very shallow water depth, equipment limitations can be expected. Line spacing will vary with water depth, but not exceed 98 ft (30 m) spacing.	

CONSTRUCTION AND OPERATIONS PLAN

Site Characterization and Assessment of Impacts – Physical Resources

Overview of Completed Geotechnical Surveys			
Survey name	Survey period	Objective	Contribution to Sunrise Wind
Bay State Wind GT1A Site (2016)	September 2016–November 2016	To characterize site conditions of MAWF.	Positions located within the central part of the SRWF. Data has been used for alignment of ground model.
Bay State Wind GT1B Site (2018)	January 2018–May 2018	To characterize WTG conditions and ground modelling of MAWF.	Positions located within the eastern half of the SRWF. Data has been used for alignment of ground model. Positions within SRWF Zone 2 and 3. Data has been used for alignment of ground model.
Bay State Wind GT2 Site (2019)	April 2019–June 2019	To characterize offshore platform conditions and ground modelling of MAWF.	Positions located within the central part of the SRWF. Data has been used for alignment of ground model.
Sunrise Wind GT1B Site (2019)	December 2019–March 2020	The purpose of this survey was to support development of the geophysical ground model, develop global soil parameters/correlations for detailed design, and to support the OCS–DC concept design.	
Sunrise Wind GT1 ECC, IAC (2020)	May 2020 – August 2020	The objective of this survey was to acquire CPT data, in-situ thermal data and vibracore samples at shallow depths (up to 20 ft (6 m) below seabed) along the SRWEC and across the SRWF for IAC.	
Sunrise Wind GT OSS (2020)	September 2020 – October 2020	The purpose of this survey was to collect site-specific geotechnical data for the proposed OCS–DC location and provide data for the detailed design of the OCS–DC foundation.	
Sunrise Wind GT HDD Nearshore (2020)	November 2020 – December 2020	The purpose of this survey was to support development of the ground model, characterize geotechnical units, facilitate soil properties derivation for cable design and installation for the SRWEC landfall.	

Table 4.3.2-2 Overview of Ongoing and Planned Geotechnical Surveys

Overview of Ongoing and Planned Geotechnical Surveys		
Planned Survey	Timeframe	Objective
GT2 Site (2021)	Survey Operation: April 2021 – Ongoing Anticipated survey completion August 2021	The objective is to acquire CPT data at each turbine location to the anticipated depth of their foundations across the SRWF.

CONSTRUCTION AND OPERATIONS PLAN

Site Characterization and Assessment of Impacts – Physical Resources

4.3.2.1 Affected Environment

Regional Geological Setting

The Northeastern American continental shelf is the result of the eastern North American rift system, which originated through the Mesozoic Era (Triassic and Jurassic Periods from 252 to 145 million years ago), creating a series of back-stepping normal faults and rift basins on the shelf (America 2012). This region of the Atlantic shelf is considered a passive margin that has not experienced any major structural events since the evolution of the rift system during the Mesozoic (Fugro 2016). Subsequent subsidence of these rift-basins has allowed for considerable sediment accumulation across the continental margin, resulting in >7.5 mi (12 km) of Mesozoic to recent sediment thicknesses in the region (Steckler and Watts 1978). Cenozoic Era (Paleogene and Neogene Periods from 66 to 2.6 million years ago) geological units were generally deposited in marine to fluvial environments formed in response to the cyclic rise and fall of sea level. Cenozoic sedimentary units generally thicken and dip gently seaward (Tetra Tech 2019).

Through the Quaternary Period (2.6 million years ago to the present), sedimentary processes in the region have primarily been dominated and shaped by glacial processes, and these types of deposits dominate the sedimentary sequence evident in the geophysical data (Fugro 2016). Figure 4.3.2-1 shows the glacial landforms identified on the Atlantic continental shelf south of Rhode Island and Massachusetts. This region lies in a boundary between glaciated and proglacial terrains. To the north, the shelf offshore of Maine was glaciated several times, while to the south, the shelf offshore of New Jersey did not experience any glaciations in the Pleistocene Epoch (Siegel et al. 2012). The most recent glacial period in North America, the Wisconsin glaciation, had its maximum extent at approximately 26,000 years Before Present (yBP), coinciding with the global sea-level low stand of the Last Glacial Maximum (LGM). During this time, the Laurentide Ice Sheet (LIS) covered most of northern North America, and its margin was situated just north of the SRWF (Figure 4.3.2-1).

The offshore region south of Rhode Island and Massachusetts, consisting of Long Island, Martha's Vineyard, Nantucket Island, Block Island, and the numerous subsea shoals in Rhode Island Sound and Block Island Sound, owes its origin to the glacial activity of the LIS. The maximum southern advance of the LIS of the Wisconsin glaciation caused the formation of the Ronkonkoma Terminal Moraine, which runs along the center of Long Island, with Montauk Point as its easternmost point. Moraines located on Block Island, Martha's Vineyard, and Nantucket Island (Figure 4.3.2-1) also mark the maximum extent of the LIS (Tetra Tech 2019). Previous desktop studies and geophysical surveys show how these moraines stretch offshore and connect as a fully submerged end moraine, in a southward arcuate manner, in Block Island Sound and Rhode Island Sound (Figure 4.3.2-1) (Fugro 2016). South of these moraines, extensive areas of glacial outwash prevailed resulting in deposits typically better sorted than glacial outwash as coarse glaciofluvial sediments, fine sands, and muds. These outwash sediments have provided sands, gravels, and muds which have been extensively reworked by rising sea levels and advancing shorelines, forming Long Island's characteristic southern shoreline sandy barrier islands and extensive back bays (Tetra Tech 2019).

CONSTRUCTION AND OPERATIONS PLAN

Site Characterization and Assessment of Impacts – Physical Resources

The location of the Project on the continental shelf, 18.9 mi (16.4 nm, 30.4 km) south of Martha's Vineyard, Massachusetts, places the SRWF immediately south of the submerged end moraine (Figure 4.3.2-1) in what was an extensive glacial outwash plain. Glacial lakes formed along the margin of the retreating ice sheet and on the exposed continental shelf, covering the site during deglaciation. The depositional environment within the range of the geophysical dataset would, therefore, have been subject to numerous meltwater pulses and discharge of glacial sediments from the LIS. This depositional environment dominated during the Wisconsin and possibly also during previous glaciations through the Quaternary. The glacial deposits can therefore consist of glacial lacustrine and glacial marine sediments. Late glacial environments consisted of subaerial meltwater plains with braided river systems, eroding channels, and infilled basins. Following the glacial retreat and subsequent sea level- rise, the continental shelf was inundated with transgressive, fluvial-estuarine deposits covering much of the outwash plain and infilled low-lying areas. These transgressive fluvial deposits may be fine grained or sandy and often laminated. As transgression continued, the depositional environment transitioned into the open marine, mid-shelf environment present in the SRWF today (Fugro 2016). The modern seabed is comprised of the Holocene transgressive system tract, and geologic conditions at the seabed are a mixture of Holocene marine sediments and relict sediment from reworked glacial deposits.

Modern sand units have been identified to have a thickness typically on the order of 6.5 to 16.4 ft (2 to 5 m) but up to 32.8 ft (10 m) in places. Beneath these modern sand units, or where these sands are absent, early Holocene finer-grained estuarine sediments and coarser glaciofluvial sediment are found. When exposed at seafloor reworking is seen, such as at the troughs between sand accumulations. Further offshore, glacial sedimentary deposit is cut by numerous paleochannels, filled with a transgressive sequence composed of reworked glaciofluvial gravelly deposits and early Holocene estuarine deposits (Schwab et al. 2000). Along Long Island in the nearshore area, shoreface-attached sand ridges are found to migrate in a southwestward direction (Schwab et al. 2016). In the area around the proposed Landfall, smaller sorted bedforms are found to be indicative of active erosion of the glacial outwash units (Schwab et al. 2016).

Regional generalized geographic characteristics are noted in Figure 4.3.2-1 with the SRWF location outlined (USACE 2016).

CONSTRUCTION AND OPERATIONS PLAN

Site Characterization and Assessment of Impacts – Physical Resources

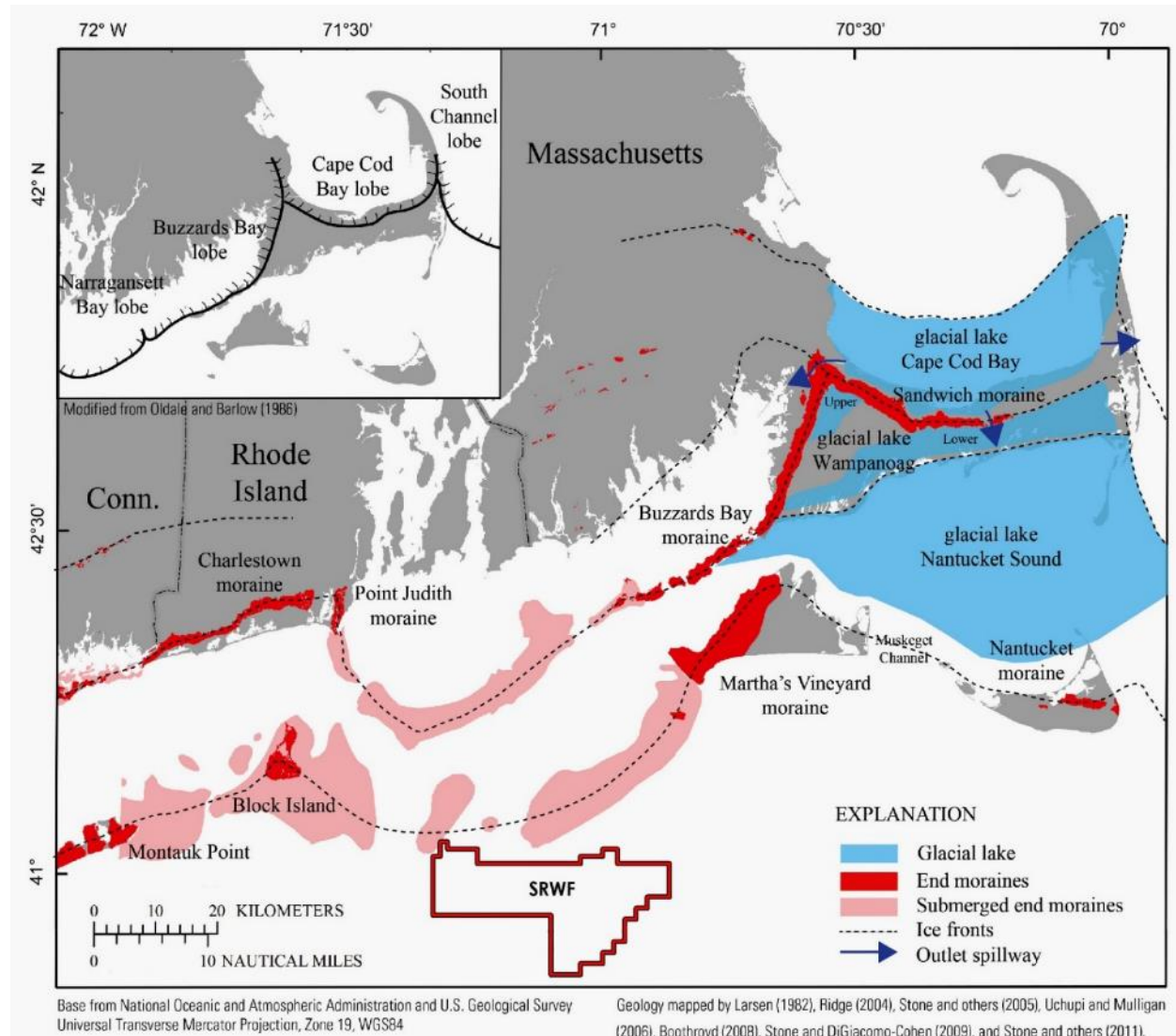

Figure 4.3.2-1 Regional Generalized Geographic Characteristics

The SRWF and SRWEC both lie within in a complex geological area. In the most recent geologic past (Pleistocene to Holocene) it was shaped by glacially driven sea level fluctuations. The whole area has been significantly influenced by glacial processes including glacial surges, glacial tectonism and sea level changes which gave rise to a variety of depositional environments from fluvial, through to estuarine and open marine. Reference materials document that the area is located in a pro-glacial setting during the most recent glaciation, the Wisconsin, which is in close agreement with the interpretations in the geological model presented in the MSIR. In the northerly extents of the SRWF there are glacial outwash deposits on the surface, originating from the most southerly extent of the Laurentide continental ice sheet, located to the north of the SRWF.

CONSTRUCTION AND OPERATIONS PLAN

Site Characterization and Assessment of Impacts – Physical Resources

Seismic activity was documented from a review of the Northeast States Emergency Consortium (NESEC) data. NESEC states that approximately 40 to 50 earthquakes are detected annually in the Northeast, which includes Connecticut, Maine, Massachusetts, New Hampshire, New Jersey, New York, Rhode Island, and Vermont (NESEC 2017a). Regionally, there has been one occurrence of seismic activity of a magnitude or intensity 4 or greater since 1965, recorded in East Hampton, New York, in March 1992 (NESEC 2017b)

The seismic hazard risk for the area is low, given the nature of the passive margin on the US East Coast. Faulting may be observed in sub-bottom profiling datasets due to differential compaction and dewatering of underlying sediment or may be driven by glaciotectionic processes. If present, these faults are unlikely to reach the surface of the seabed and typically should not pose a significant engineering concern to cable routing.

Geologic hazards are considered any significant geological feature that can pose a significant hazard with respect to foundation installation and cable route burial in the SRWF and SRWEC. Boulders are the predominant geohazards in the region and may occur at the SRWF and SRWEC locations based on the glacial history of the region. Singular boulders and boulder fields have been interpreted and are distributed in the northern portion of the SRWF and in the nearshore portion of the SRWEC–NYS. Sharp topographic features may also pose a hazard. Sand waves are migrating depositional features, generally understood to form from sediments that are transported and redeposited by bottom currents (Wynn and Stow 2002). Sand waves may be present in the region; however, within the marine portions of the Project Area, no sand waves were identified..

A detailed discussion of the natural and anthropogenic hazards identified within or excluded from the SRWF and SRWEC is provided in Appendix G1. Tables 8.1, 8.2, and 8.3 of Appendix G1 define each hazard type and summarizes its presence and/or absence within the SRWF and SRWEC corridor based on HRG and geotechnical data collected within these areas to date, as well as agency outreach and desktop studies.

Sunrise Wind Farm

Water depths in the SRWF vary between approximately 115 to 203 ft (35 to 62 m) MLLW. The seabed slopes very gently from north to south with an average gradient of < 0.1 degrees (0.15%). Within boulder fields, the seabed gradients locally exceed 5 degrees (Appendix G1).

Sediments across the site are generally a mix of sand and muddy sand in the southwest and coarser materials in the north and east. There are intermingled patches of mixed sediments, notable in the center and northeast as well as occasional lenses of muddy sediments. The finer grained sand and muddy sand materials correlate with raised areas of the seabed, while the coarser sediments correlate with areas of ripples. Surficial sediments have been mapped for a portion of SRWF based on completed surveys as detailed in Appendix G1. Several regions have been classified as glacial outwash to conform with the morphological interpretation of an irregular seafloor in these areas. These regions of glacial outwash are only identified in the north of the site and are associated with high density boulder fields (Appendix G1).

CONSTRUCTION AND OPERATIONS PLAN

Site Characterization and Assessment of Impacts – Physical Resources

The SRWF is located adjacent to, and south of, a terminal glacial moraine—a high boulder hazard area. Sources for boulders typically include moraine deposits, glacial outwash, and glacial erratics transported by ice rafts in front of the glaciers and deposited when the ice rafts melted. Recent mapping by Fugro from the *Geophysical Survey and Shallow Hazards Report* for the South Fork Wind Farm (Fugro 2019) and more recent Project surveys (Appendix G1) suggest that the northwest corner of the SRWF may be located adjacent to a terminal moraine as depicted in Figure 4.3.2-1. The northernmost areas are characterized by superficial glacial outwash deposits and dense boulder fields. Several discrete areas of irregular seafloor are identified in regions of high-density boulder fields displaying a textured relief associated with the glacial sediment (Appendix G1).

Sand waves are present in the offshore environment, but in the current interpretation of the site, no sand waves have been identified within the SRWF. However, Sunrise Wind has taken a conservative approach and assumed that a maximum of 5 percent of the IAC within the SRWF will require sand accumulation removal prior to cable installation. The actual number will be refined following the results of additional sediment mobility studies. Where required, Sunrise Wind has assumed the route would be cleared of a sand accumulations centered on the final IAC centerline. Other mobile sediment bedforms, such as mega ripples and ripples, have been identified. Sand accumulation areas, which represent low relief areas of more immobile sand have also been identified.

Lithological units have been identified for portions of the SRWF are shown in Appendix G1. Distribution of the geologic units across the site is highly heterogenic. Multiple erosive surfaces are evident, and infilled channels, valleys and minor basins are observed in these units. Infill may have been deposited through fluvial and glacio-fluvial processes or as a result of meltwater discharge pulses across the shelf. The area has been influenced by sea level changes resulting in landscape alterations and glacial processes including glacial surges, glaciotectonics and sea level changes, which has influenced the depositional environment and sediments along the SRWEC–OCS (Appendix G1).

Sunrise Wind Export Cable–OCS

Geological characteristics along the SRWEC–OCS are provided in Appendix G1. The seabed consists mainly of chaotic and unstructured sandy sediment with sedimentary features of ripples, mega ripples, and sand accumulation areas. In the current interpretation of the route, no sand waves have been identified along the SRWEC–OCS. However, within the SRWEC–OCS, Sunrise Wind has assumed that a maximum of 10 percent of the SRWEC–OCS will require sand leveling prior to cable installation due to sand accumulation areas.

The actual number will be refined following the results of additional sediment mobility studies. Where required, Sunrise Wind has assumed the route would be cleared of sand Accumulations.

Sand ripples and mega ripples have been identified across the length of the SRWEC–OCS as both small, isolated patches and spanning larger areas, with sections greater than 6 mi (10 km) in length. The seabed sediments are dominated by sand and muddy sand, except for discreet patches of mixed and coarse sediment.

CONSTRUCTION AND OPERATIONS PLAN

Site Characterization and Assessment of Impacts – Physical Resources

Sunrise Wind Export Cable–NYS

Geological characteristics along the SRWEC–NYS are provided in Appendix G1. Boulder fields, predominantly of medium density, and sand accumulation areas were identified in the nearshore area of SRWEC–NYS (Appendix G1). Sunrise Wind has assumed a conservative maximum of 40 percent of the SRWEC–NYS will require sand accumulation removal prior to cable installation. The actual number will be refined following the results of additional sediment mobility studies.

Onshore Facilities

The geology of Long Island is dominated by terminal moraines and glacial outwash deposits derived from Wisconsinan Laurentide glacial advance and retreat, accompanied by Holocene sea-level transgression, which eroded and redistributed outwash deposits to form the present barrier-island system (Leatherman 1985). Figure 4.3.2-2 and Figure 4.3.2-3 depict the generalized terrestrial strata and the terrestrial surficial sediments, respectively, in the vicinity of the Onshore Facilities.

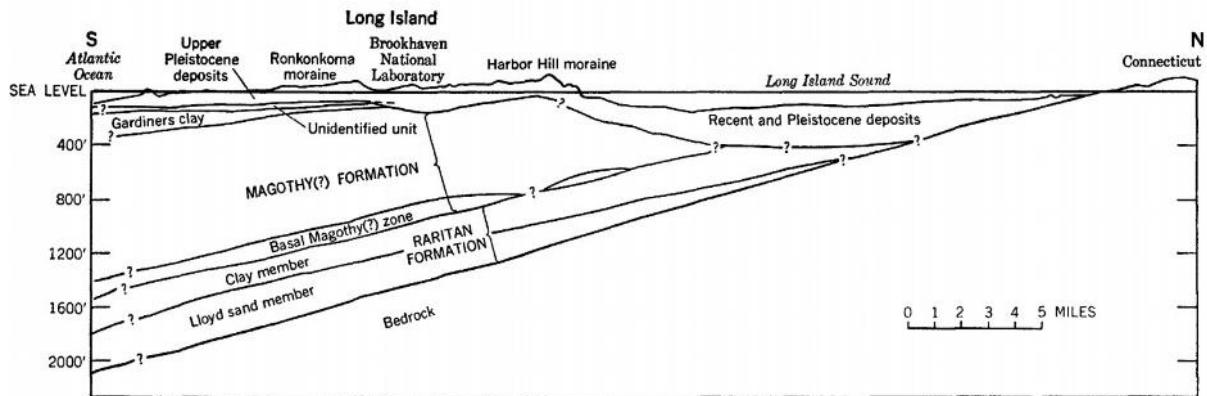
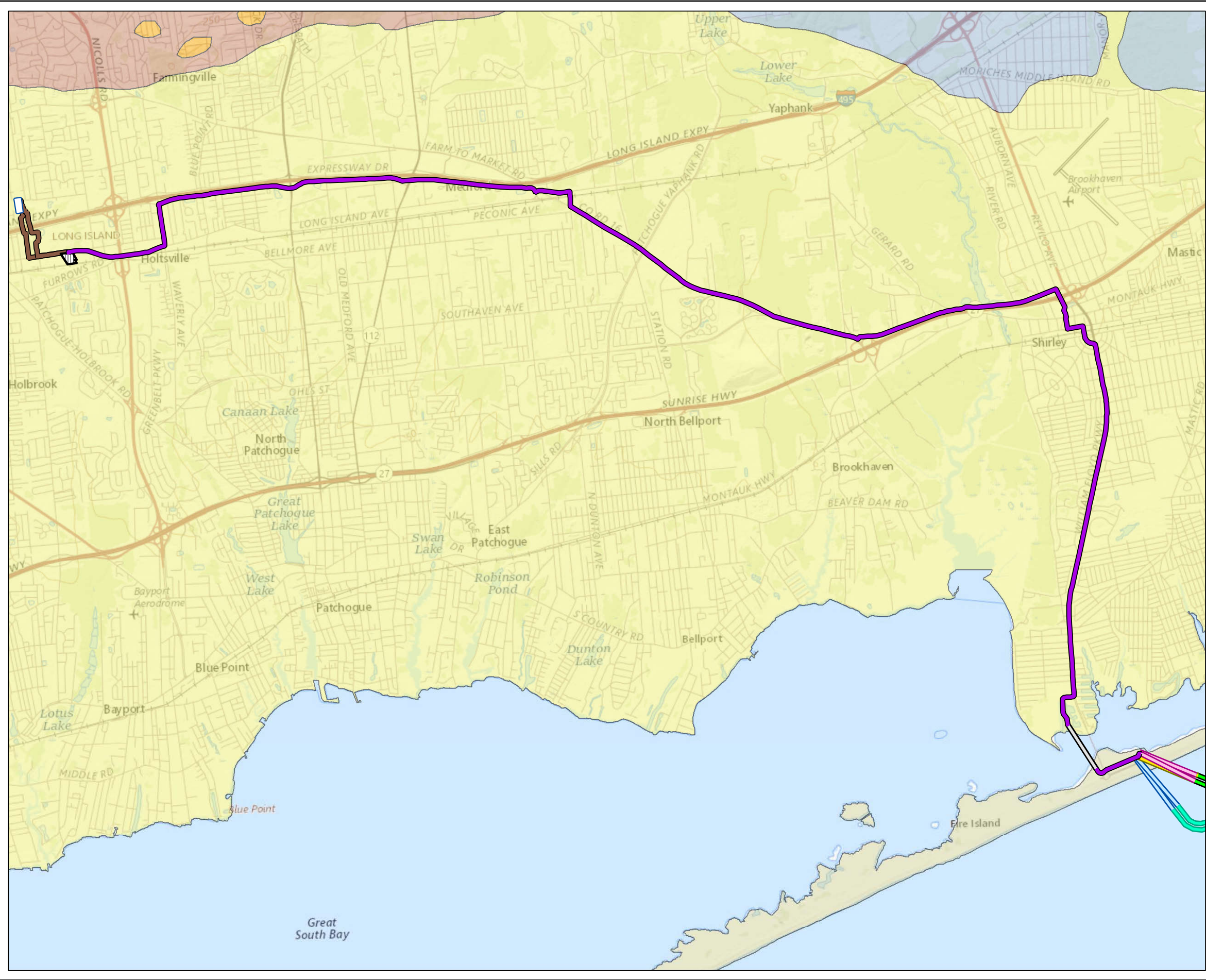

Figure 4.3.2-2 Generalized Cross-section from de Laguna (1965)

Approximate depths in ft. Southern (left) edge of profile is within several km of the proposed Smith Point Landfall.

V:\1956\active_Task Owner and other Non-BC\1956_Jobs\2028113199\03_data\gis_cad\gis\Map\XDs\COP\2028113199_4.3.2-3_TerrestrialSediments.mxd Revised: 2021-05-07 By: gearpantier



**Figure 4.3.2-3
Terrestrial Surficial Sediments**

Sunrise Wind | Powered by Ørsted & Eversource

Legend

- Sunrise Wind Export Cable (SRWEC-NYS)
- SRWEC-NYS (Western Landfall Option)
- Landfall HDD A
- Landfall HDD B
- Landfall HDD C
- Intracoastal Waterway HDD (ICW HDD)
- Onshore Transmission Cable-LIE Service Road Route
- Onshore Interconnection Cable Route
- Union Avenue Site
- Holbrook Substation

New York Surficial Geology (1:250,000)

- Barrier Island
- Kame Deposits
- Kame Moraine
- Outwash and Sand/Gravel
- Till Moraine

Notes

1. SRWEC route will have one landfall location. Routes are indicative and subject to engineering design changes.

Sources

Surficial Geologic Map of New York - Lower Hudson Sheet, 1989.
Base map: USGS The National Map

Date	12/18/2020 Revised: 6/1/2021
Project Number	2028113199
Prepared By	PB
Reviewed By	LJ

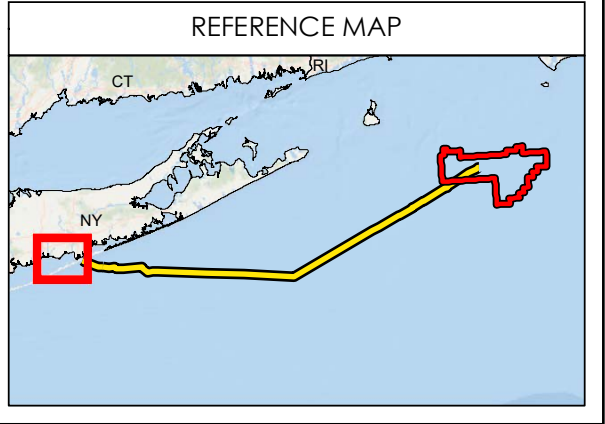
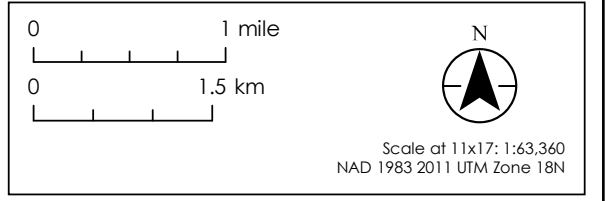

This page intentionally left blank

CONSTRUCTION AND OPERATIONS PLAN

Site Characterization and Assessment of Impacts – Physical Resources

The land mass of Long Island is also a product of glacial and post-glacial processes. The Wisconsin episode is predominantly responsible for the surficial geology of the modern Long Island region. During the Wisconsin glacial stage, an ice sheet moved to approximately the center of Suffolk County and stopped, leaving before it two terminal moraines, which are now known as the Ronkonkoma moraine and the Harbor Hills moraine. After the ice sheet reached its southern limits in Suffolk County, it began to melt. The melted water flowed into streams and carried a large volume of sand and gravel farther south. This sand and gravel were deposited in two relatively flat outwash plains: one between the Ronkonkoma moraine and the Atlantic Ocean and the other between the Harbor Hill moraine, which extends from the western edge of Nassau County, along the northern shore of Long Island, to its easternmost point at Fisher's Island, and the Ronkonkoma moraine (USDA 1975).

The Ronkonkoma moraine and the Harbor Hills moraine are parallel in the western half of Long Island but diverge near Peconic Bay. The Harbor Hill moraine and the Ronkonkoma moraine are comprised primarily of poorly sorted till, including sand, pebbles, rocks, and boulders, while the outwash plains located between the moraines, and south of the Ronkonkoma moraine, include varying amounts of well-sorted sand and gravel. The Ronkonkoma moraine was deposited as a terminal moraine at the end of a glacial lobe and forms the spine of Long Island (Sanders and Merguerian 1994). Streams draining southward at the edge of the glacier deposited an outwash plain of sandy material that is now the southern Long Island coastal zone and shore.

Fire Island is a 31 mi (50 km) long barrier island extending from Fire Island Inlet (Democrat Point) eastward to Moriches Inlet. This barrier island is part of a barrier system which runs parallel to the south shore of Long Island. These barriers are known to be migrating westward as sediment eroded from the Montauk Point area is carried by longshore currents. Sediments that nourish Fire Island are believed to come primarily from several sources. The eroding headland section of the Montauk Point area is a major source of sediment for the barrier islands, with offshore and inlet scouring contributing sources as well (Taney 1961).

The stratigraphy underlying the Holocene shoreline deposits and back-bay salt marshes consists of Pleistocene units unconformably overlying truncated Upper Cretaceous coastal plain deposits. The Coastal Plain Unconformity separates the lowermost Pleistocene deposits, known as the Gardiners Clay unit from the truncated strata of the Coastal Plain deposits, assumed to be the Cretaceous Magothy Formation. Near Smith Point, the thickness of the Quaternary deposits (i.e., the Gardiners Clay, the Pleistocene outwash, and Holocene shoreface deposits) is mapped to be on the order of 49 to 98 ft (15 to 30 m) according to an analysis by Foster et al. (1999), which integrated onshore well logs with offshore seismic profiles. The bedrock under Suffolk County varies in depth from approximately 400 ft (121 m) below ground surface (bgs) along the northern coastline of the town of Southold, to approximately 2,000 ft (609 m) bgs along the central part of the southern coastline of Fire Island.

A series of interconnected shallow inshore bays or lagoons separate the barrier islands from the mainland, known as the South Shore Estuary. This tidal estuarine environment consists of marshes, sand and mud flats, beds of submerged aquatic vegetation, and broad shallow areas lightly incised with deeper channels. Previous breaches have occurred and healed, leaving relict flood-tide sand deltas extending into the back-bay areas. The barrier islands typically vary between 984 and 2,625 ft (300 and 800 m) in width.

CONSTRUCTION AND OPERATIONS PLAN

Site Characterization and Assessment of Impacts – Physical Resources

The shoreward face is constantly reworked by waves and tidal action, with a profile that changes seasonally and with severe weather events. Behind the beach facies are typically wind-blown dunes composed of fine to medium sands, which can reach a height of 13 to 23 ft (4 to 7 m). Behind the dunes may be a predominantly fresh-water wetland or salt-water tidal wetland, which then gives way to the shallow waters of the estuary. The beaches are composed of sands with little coarser gravels or cobbles present, except where the barrier beaches are closest to the mainland, where coarser materials may be more readily sourced from Pleistocene outwash deposits.

4.3.2.2 Potential Impacts

Construction, O&M, and decommissioning activities associated with the Project have the potential to cause both direct and indirect impacts on the geological conditions, as discussed in the following sections. IPFs associated with the construction and O&M phases for the SRWF, SRWEC, and Onshore Facilities are described below. For the decommissioning phase of the Project, impacts are anticipated to be similar to or less adverse than those described for construction; therefore, impacts from decommissioning are not addressed separately in this section. An overview of the IPFs for geological conditions associated with the Project is presented on Figure 4.3.2-4.

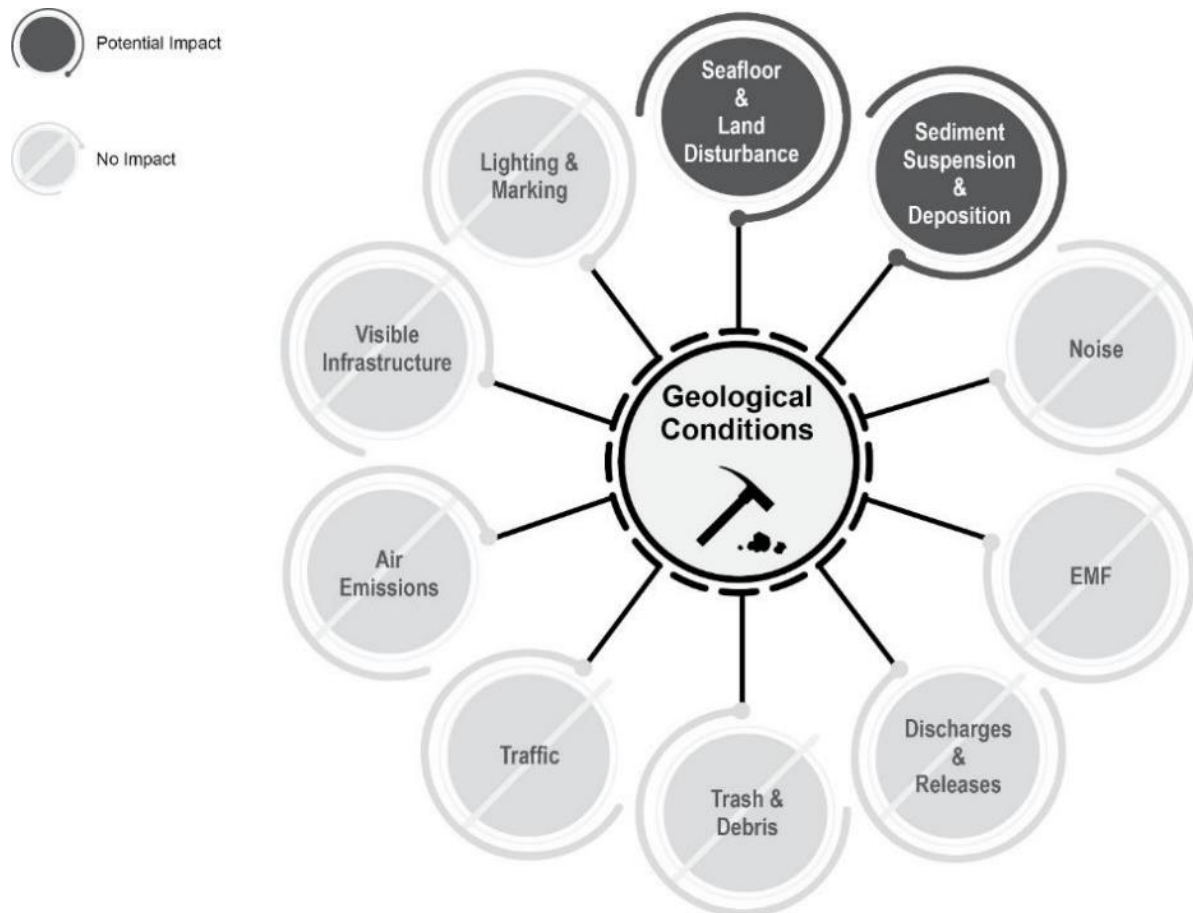

Figure 4.3.2-4 Impact-Producing Factors on Geological Conditions

CONSTRUCTION AND OPERATIONS PLAN

Site Characterization and Assessment of Impacts – Physical Resources

Construction of the SRWF and SRWEC will result in temporary seafloor disturbance and sediment suspension and deposition. Impacts to geological conditions will be limited due to the minimal disturbance of the seafloor relative to the vastness of the resource. Construction and O&M of the SRWF and SRWEC will alter the seafloor composition and topography in the immediate areas. Cable burial will mostly affect surficial geological conditions, but not to such an extent that there would be a perceptible change in the overall regional geological conditions.

The SRWF and SRWEC will be designed to address existing geologic hazards and minimize direct and indirect effects on the seafloor, as well as minimize sediment suspension and deposition. Similarly, cable embedment will directly disturb the seafloor and cause sediment suspension in the lower water column and indirect effects associated with sediment deposition.

Construction of the Onshore Facilities will be on land and will involve trenchless construction methods as well as conventional trenching and excavation. Trenching for transmission duct banks will generally be excavated in and along the sides of roads and will be restored by backfill operations. Construction will affect surficial geologic resources but not to such an extent that there would be a perceptible change in the overall regional geological conditions. All Onshore Facilities work will be conducted following strict NYS PDES permit conditions, which require erosion and sediment control management minimizing any adverse effects associated with sediment suspension and deposition.

Sunrise Wind Farm

Construction

Seafloor Disturbance

Seafloor disturbance from foundation installation, IAC installation, and anchoring would impact geologic resources. Mainly surficial and subsurface geological conditions at specific installation locations would be impacted from foundation penetration (i.e., pile driving), cable installation, and anchoring. Monopile foundation installation for WTGs will result in subsurface impacts extending up to approximately 164 ft (50 m) into the seabed. The piled jacket foundation for the OCS–DC will be embedded up to approximately 295 ft (90 m) into the seafloor. Alteration of the strata by the installation of the foundations will occur at each pile point but will not result in a broader scale impact to the geologic setting of the area. The disturbance of the geological strata will be limited to each pile point or the circumference of the pile and Sunrise Wind has committed to an indicative layout scenario with WTGs and the OCS–DC sited in a uniform east-west/north-south grid with 1.15 by 1.15-mi (1 by 1-nm; 1.85 by 1.85-km) spacing. Disturbance will not occur on a broader scale that would alter the geological resource.

The presence of boulders on the seafloor within the SRWF is the likely primary geologic hazard identified by pre-construction assessments, as described in Appendix G1. The siting of the SRWF areas avoids shallow hazards to the extent practicable. However, where construction activities result in the movement of boulders or depositional features (e.g., ripples, sand accumulations) impacts would be short-term, localized, and temporary.

CONSTRUCTION AND OPERATIONS PLAN

Site Characterization and Assessment of Impacts – Physical Resources

Sediment Suspension and Deposition

Surficial geological conditions, mostly comprised of (recent) Holocene pre-transgressive and transgressive marine sediments, would be impacted mainly because of sediment suspension/deposition from the IAC installation resulting in localized changes to surficial geology and bottom topography. Installation of the IAC using the mechanical cutter, mechanical plow (which may include a jetting system), and/or jet plow is expected to result in the disturbance and temporary suspension and re-deposition of these deposits, as described in the Appendix H and further assessed in Section 4.3.3. Sedimentation resulting from the installation of the IAC would be limited to the area immediately adjacent to the burial route. These impacts are considered to be short-term and localized because of the limited extent of sedimentation predicted by the model and the highly dynamic nature of the marine sediments in the SRWF.

As explained above in the discussion of seafloor disturbance, the presence of boulders on the seafloor within the SRWF is the primary geologic hazard identified by pre-construction assessments, as described in Appendix G1. The siting of the SRWF IAC will avoid these hazard areas to the extent practicable. From the perspective of geological conditions, impacts from leveling of sand accumulation areas and movement of boulders will be direct, short-term, and limited, as the overall stratigraphy of the geologic deposits will not be significantly altered.

Operations and Maintenance

Seafloor Disturbance

Once the SRWF is constructed and operational, no impacts to geologic resources are anticipated except for vessel anchoring during routine and non-routine maintenance, and the very low likelihood that the IAC requires replacement, relocation, or additional armoring. In the circumstances that seafloor disturbances occur during the O&M phase, impacts would be similar to those discussed for construction of the SRWF on a smaller scale.

Sediment Suspension and Deposition

Scour at the base of the WTG foundations will locally impact surficial geology during the O&M phase. Scour protection will be placed at the base of each WTG foundation and on top of the segments of the IAC where they emerge from the trench and connect into the WTG and OCS–DC. Short-term impacts to Holocene marine deposits from sediment suspension and deposition around the artificial structures are expected during O&M, but broad-scale geologic resources impacts are unlikely.

CONSTRUCTION AND OPERATIONS PLAN

Site Characterization and Assessment of Impacts – Physical Resources

Sunrise Wind Export Cable–OCS

Construction

Seafloor Disturbance

Impacts to geologic resources during construction of the SRWEC–OCS would be limited to the mechanical cutter, mechanical plow (which may include a jetting system), and/or jet plowing of the seafloor during cable installation to a typical depth of 3 to 7 ft (1 to 2 m). Similar to the seafloor disturbance described above for the SRWF foundations and IAC, installation of the SRWEC would result in short-term impacts to localized geologic resources such as marine deposits (sediments) and near-surface stratigraphy. Broad-scale geologic features would not be measurably impacted.

Sediment Suspension and Deposition

Surficial geological conditions, mostly comprised of (recent) Holocene pre-transgressive and transgressive marine sediments, would be impacted mainly because of sediment suspension/deposition from the SRWEC–OCS installation resulting in localized changes to surficial geology and bottom topography. Installation of the SRWEC–OCS using the mechanical cutter, mechanical plow (which may include a jetting system), and/or jet plow is expected to result in the disturbance and temporary suspension and re-deposition of these deposits, as described in Appendix H. Sedimentation resulting from the installation of the SRWEC–OCS would be limited to the area immediately adjacent to the burial route. These impacts are considered to be short-term and localized based on the sedimentation predicted by the model and the highly dynamic nature of the marine sediments along the SRWEC–OCS route.

The potential presence of boulders on the seafloor along the SRWEC–OCS route is the primary anticipated geologic hazard identified, as described in Appendix G1. The siting of the SRWEC–OCS avoids these hazard areas to the extent practicable. Where construction activities result in the movement of boulders or depositional features (e.g., ripples, sand accumulations) impacts would be short-term and localized. From the perspective of geological conditions, impacts from leveling of sand accumulations and movement of boulders will be direct, short-term, and limited, as the overall stratigraphy of the geologic deposits will not be significantly altered.

Operations and Maintenance

Seafloor Disturbance

No impacts to geological conditions from SRWEC–OCS operations are anticipated. If mechanical damage to the SRWEC–OCS should occur, repair of the cable may result in disturbance to the seafloor from maintenance vessels and activities. Localized impacts to marine deposits would be short-term and temporary.

Sediment Suspension and Deposition

No impacts to geological conditions from SRWEC–OCS operations are anticipated. If mechanical damage to the SRWEC–OCS should occur, repair of the cable may result in sediment suspension and deposition from maintenance vessels and activities. Localized impacts to marine deposits would be short-term and temporary.

CONSTRUCTION AND OPERATIONS PLAN

Site Characterization and Assessment of Impacts – Physical Resources

Sunrise Wind Export Cable–NYS

Construction

Seafloor Disturbance

Impacts to geologic resources during construction of the SRWEC–NYS would be limited to the mechanical cutter, mechanical plow (which may include a jetting system), and/or jet plowing of the seafloor during cable installation and HDD construction methods. SRWEC–NYS installation impacts to Holocene deposits consisting of medium to coarse sand with some gravel resources would be from the SRWEC–NYS installation. HDD techniques will minimize impacts to surficial sediments, compared to an open trench installation. Also, measurable impacts to geologic resources from the SRWEC–NYS installation, including the HDD process, would be limited for the overall geologic resources and processes in the area. The temporary exit pit installed nearshore for the HDD installation would result in short-term and localized impacts to Holocene sediments, but no permanent or long-term impact to geologic resources are expected.

Sediment Suspension and Deposition

According to the results of the sediment transport model, sediment will be disturbed and temporarily suspended during installation of the SRWEC–NYS (Appendix H). The model predicted that sediment suspension and deposition resulting from installation of the SRWEC–NYS will be limited to the area immediately adjacent to the burial route. Localized impacts to marine deposits would be short-term and temporary.

Sediment suspension and deposition from excavation of the HDD exit pit were predicted to occur within a very small radius of the activity. Any localized impacts to marine deposits would be short-term and temporary.

From the perspective of geological conditions, impacts from leveling of sand waves and movement of boulders will be direct, short-term, and limited, as the overall stratigraphy of the geologic deposits will not be significantly altered.

Operations and Maintenance

Seafloor Disturbance

No impacts to geological conditions from SRWEC–NYS operations are anticipated. If mechanical damage to the SRWEC–NYS should occur, repair of the cable may result in disturbance to the seafloor from maintenance vessels and activities. Localized impacts to marine deposits would be short-term and temporary.

Sediment Suspension and Deposition

No impacts to geological conditions from SRWEC–NYS operations are anticipated. If mechanical damage to the SRWEC–NYS should occur, repair of the cable may result in sediment suspension and deposition from maintenance vessels and activities. Localized impacts to marine deposits would be short-term and temporary.

CONSTRUCTION AND OPERATIONS PLAN

Site Characterization and Assessment of Impacts – Physical Resources

Onshore Facilities

Construction

Land Disturbance

Power from the Project will be delivered to the electric grid via an OnCS–DC to be constructed in the Town of Brookhaven, Long Island, NY. Interconnection to the electric grid will occur at the existing Holbrook Substation also located in the Town of Brookhaven, NY. Delivery of the power will require construction of a new OnCS–DC. The maximum area of land disturbance during construction of the OnCS–DC is approximately 7 acres (2.8 ha) (as defined in Table 3.3.1-4). On site construction activities will be conducted in compliance with the SPDES General Permit and an approved SWPPP.

Construction of the Onshore Transmission Cable to the OnCS–DC would originate at the Landfall HDD TJB on the eastern portion of Smith Point County Park, with a second HDD crossing under the ICW via the ICW HDD. The Onshore Transmission Cable would then follow the LIE Service Road Route to the OnCS–DC. Construction of the Onshore Transmission Cable and Onshore Interconnection Cable will involve site preparation, duct bank installation, restoration, cable installation, cable jointing, and final testing, with additional steps associated with HDD and other trenchless crossing methods.

Previously disturbed areas within and along roadways will be excavated and trenched for burial of the Onshore Transmission Cable and Onshore Interconnection Cable vaults resulting in the mixing of the existing soil horizons. Trenches for the Onshore Transmission Cable duct banks will generally be located within the ROW of existing paved roadways. Duct bank disturbance will extend 3 to 6 ft (1 to 2 m) below grade, with the width of temporary disturbance of 30 ft (9.1 m). Splice vaults will be installed approximately every 2,000 to 2,500 ft (609 m to 762 m) and will result in temporary disturbance of 50 by 40 ft (15 by 12 m) horizontal and a depth of up to 15 ft (4.6 m) at each splice vault. Up to two TJBs will be installed at the connection from the SRWEC to the Onshore Transmission Cable. TJB disturbance will extend 13 ft (4 m) below grade with a temporary disturbance at the surface of 0.03 ac (0.01 ha) (see Table 3.3.3-3). The Union Avenue Site is depicted in Figure 3.3.1-1. Equipment and structures for the OnCS–DC will be supported on foundations expected to be of concrete and will be of a design suitable for existing soil conditions. The majority of the site equipment will require shallow foundations, 4 to 5 ft (1.2 to 1.5 m) in depth based on the expected equipment size. Larger structures may require drilled shaft equipment foundations of 12 to 30 ft (4 to 9 m) in depth. Following installation, all trenches will be backfilled, and surface grades will be stabilized and returned to pre-construction conditions where practicable. Overall, there will be limited direct impacts to geological conditions, and these will be short-term.

CONSTRUCTION AND OPERATIONS PLAN

Site Characterization and Assessment of Impacts – Physical Resources

Sediment Suspension and Deposition

Sediment suspension and deposition for Onshore Facilities is anticipated to have limited impacts to surficial geology as all earth disturbances from onshore construction activities will be conducted in compliance with the SPDES General Permit and an approved SWPPP. Implementation of the permit requirements and BMPs associated with these plans will minimize the potential for soil erosion and sediment drift into adjacent wetlands and waterbodies during construction activities and storm events and will ensure proper restoration of disturbed workspace locations following construction of the Project. As a result, impacts to geological conditions will be direct, short-term, and limited.

Operations and Maintenance

Land Disturbance

Operation of the Onshore Facilities will result in an OnCS–DC operational footprint size of up to 6 acres (2.4 ha), and permanent subsurface disturbance associated with installation of the duct bank, splice vault, and TJBs (see Table 3.3.1-4). Impacts to geological conditions could occur during the O&M phase in the unlikely event that the Onshore Transmission Cable or Onshore Interconnection Cable require repair or replacement. These short-term impacts would be less than the disturbances associated with the construction phase, and generally confined to previously disturbed locations.

Sediment Suspension and Deposition

As detailed above, sediment suspension and deposition along the Onshore Transmission Cable and Onshore Interconnection Cable during repair would have limited impacts to surficial geology as all earth disturbances from onshore construction activities will be conducted in compliance with the SPDES General Permit and an approved SWPPP to ensure that surficial sediments do not wash into wetlands or waterbodies or impact resource areas during storm and runoff events. These impacts would be less than during construction.

4.3.2.3 Proposed Environmental Protection Measures

Several environmental protection measures will reduce potential impacts to geological conditions. Sunrise Wind will implement the following environmental protection measures to reduce potential impacts on the geological conditions. These measures are based on protocols and procedures successfully implemented for similar offshore projects.

- The SRWF and SRWEC will avoid identified shallow hazards, to the extent feasible.
- To the extent feasible, installation of the SRWEC and IAC will occur using methods such as mechanical plow, jet plow, and/or mechanical cutter for installation of the IAC and SRWEC will minimize impacts to surficial geology, compared to open-cut dredging.
- Use of monopile and piled jacket foundations with associated scour protection will minimize impacts to surficial geology, compared to other foundation types.

CONSTRUCTION AND OPERATIONS PLAN

Site Characterization and Assessment of Impacts – Physical Resources

- Dynamic positioning (DP) vessels will be used for installation of the IAC and SRWEC to the extent practicable. Use of DP vessels will minimize impacts to the seabed, compared to use of a vessel relying on multiple anchors. The SRWEC Landfall will be installed via HDD to avoid impacts to the nearshore zones and surficial geologic resources. The Onshore Transmission Cable will also be installed via HDD under the ICW to avoid impacts to coastal resources; HDD and trenchless methods will also be used elsewhere onshore, where appropriate, to minimize impacts to surface locations and resource areas.
- Onshore Facilities are primarily sited within previously disturbed and developed areas (e.g., roadways, ROW, developed industrial/commercial areas) to the extent feasible, to minimize impacts to undisturbed surficial geology.
- A SWPPP, including erosion and sedimentation control BMPs and revegetation measures, will be implemented to minimize potential water quality impacts and limit sediment drift, transport, and deposition from construction and O&M of the Onshore Facilities.

4.3.3 Water Quality

This section describes the affected environment and potential effects from the construction and operation of the Project as they relate to water quality. The description of the affected environment and assessment of potential impacts to water quality were developed by reviewing current public data sources related to water quality, including state and federal agency-published papers and databases; online data portals and mapping databases (e.g., EPA Waste Disposal Site Mapper, EPA Sole Source Aquifer Mapper, OceanReports Tool, and Marine Cadastre Mapper); environmental studies; published scientific literature relating to relevant water quality monitoring and existing water quality datasets; and correspondence and consultation with federal and state agencies. Specific requirements for submittal of water quality information within this COP are provided in BOEM's Guidelines for 30 CFR § 585.62 pursuant to 30 CFR Part 585 Subpart F. A description of the water quality in all crossed waterbodies in the Project Area is provided below, followed by an evaluation of potential Project-related impacts. More detailed information concerning water quality in all crossed waterbodies is presented in Appendix H – *Sediment Transport Modeling Report* and Appendix M – *Benthic Resources Characterization Report*. Permits related to water quality that the Project will obtain are identified in Section 1.4.

CONSTRUCTION AND OPERATIONS PLAN

Site Characterization and Assessment of Impacts – Physical Resources

4.3.3.1 Affected Environment

Regional Overview

The SRWF is located offshore on the OCS, southeast of Block Island and Rhode Island Sound on the Atlantic OCS. Water quality data specific to this area is limited; however, the SRWF overlaps the large geographic area covered by the National Coastal Condition Reports (NCCRs) prepared by the EPA's Office of Research and Development and Office of Water. The EPA rated the quality of the nation's coastal waters as 'poor,' 'fair,' or 'good' in the NCCR based on data collected at 238 sampling locations from the coastlines of Maine through Virginia. The NCCR presents an assessment of data collected from 2003 to 2006 using physical and chemical indicators to rate water quality. These indicators include concentrations of phosphorous, nitrogen, dissolved oxygen (DO), salinity, and chlorophyll *a*, along with pH and water clarity (turbidity). Many sample sites were located within the Mid-Atlantic Bight (defined as the coastal and offshore waters from Nantucket Shoals off of southern New England to the waters of Cape Lookout off of North Carolina), which contains the SRWF, and will be crossed by the SRWEC. At the time of the report, samples collected from these sites did not contain any major indicators of poor water or sediment quality (EPA 2012). Additionally, the New York – New Jersey Bight (which the BOEM defines as the shallow waters between Long Island to the north and east, and the New Jersey coast to the south and west) will be crossed by the SRWEC, as described in the following sections. Once the SRWEC makes landfall at Smith Point County Park, HDD will occur underneath the ICW to connect to the Onshore Facilities. For the purposes of the water quality analysis, data from Great South Bay was used as representative data for the ICW where applicable, as the bay has greater availability of water quality data and is connected and immediately adjacent to the ICW.

The Mid-Atlantic Bight and New York – New Jersey Bight regions as well as the named waterbodies (both offshore and onshore) crossed by Project components are illustrated in Figure 4.3.3-1.

V:\1956\active_Task Owner and other Non-BC\1956_Jobs\2028113199\03_data\gis_ced\gis\Map\KDs\COP\2028113199_4.3.3-1_CrossedWater.mxd Revised: 2021-05-07 By: gcarpenlier

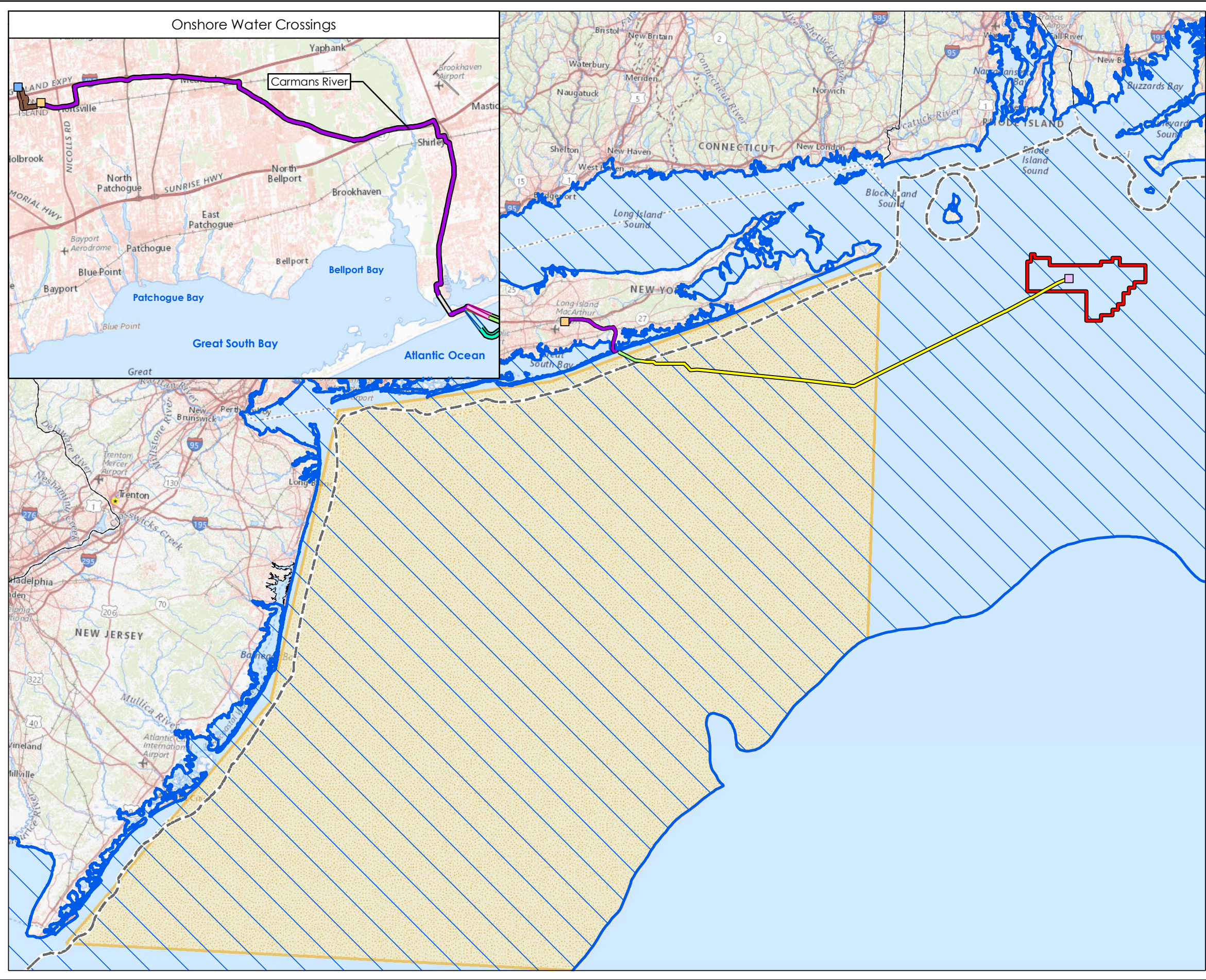

Figure 4.3.3-1
The Mid-Atlantic Bight and New York Bight Regions and Waterbodies Crossed by the Project

Sunrise Wind | Powered by Ørsted & Eversource

Legend

- Sunrise Wind Farm (SRWF)
- Offshore Converter Station (OCS-DC)
- Union Avenue Site
- Holbrook Substation
- Sunrise Wind Export Cable (SWREC-OCS)
- Sunrise Wind Export Cable (SWREC-NYS)
- SRWEC-NYS (Western Landfall Option)
- Landfall HDD A
- Landfall HDD B
- Landfall HDD C
- Intracoastal Waterway HDD (ICW HDD)
- Onshore Transmission Cable
- I/E Service Road Route
- Onshore Interconnection Cable Route
- 3-nm State Waters Boundary
- New York-New Jersey Bight
- Mid-Atlantic Bight

Note
 Routes are indicative and subject to engineering design changes.

Sources
 Base Map: USGS The National Map

Date	12/18/2020 Revised: 6/1/2021
Project Number	2028113199
Prepared By	PB
Reviewed By	LJ

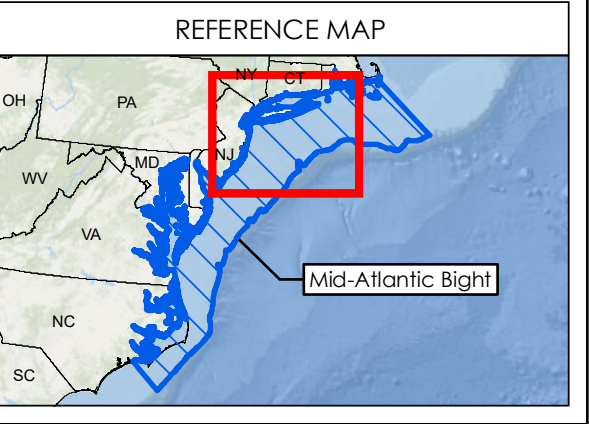
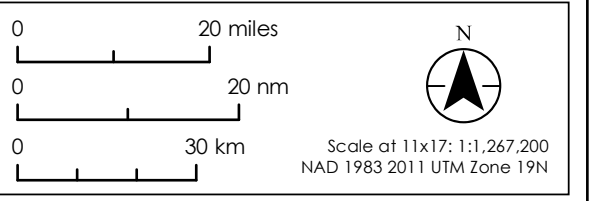

This page intentionally left blank

CONSTRUCTION AND OPERATIONS PLAN

Site Characterization and Assessment of Impacts – Physical Resources

Water quality within the Project Area is managed at both the state and federal level through USACE and BOEM's implementation and management of the CWA, concurrence with the CZMP Federal Consistency Determination, and conformance with the Rhode Island Code of Regulations' (RICR) governing seawater quality (250-RICR-150-05-1). Additionally, NYSDEC collects, monitors, and manages data on all inland waterbodies, as well as estuarine and coastal waters (6 NYCRR Part 703). NYSDEC therefore has jurisdiction over the waterbodies crossed by the Onshore Facilities (the ICW and Carmans River) and the coastal state waters of New York crossed by the SRWEC–NYS (as outlined above in Figure 4.3.3-1). BOEM has jurisdiction over offshore water quality for federal waters containing portions of the SRWEC and the SRWF, under the *Outer Continental Shelf Lands Act* of 1953. The NYSDOS, RI CRMC, and MACZM are the regulating authorities for concurrence of the Project with the CZM Federal Consistency Certification. As detailed in Section 1.0 (Table 1.4-1), Sunrise Wind will apply for all federal and state permits applicable to water quality within the Project Area in addition to consultations with all regulating authorities.

Sunrise Wind Farm

Although there is limited information available on offshore water quality specific to the SRWF, the following section provides general information on water quality and water resource conditions in the waters offshore of Rhode Island, as defined by the parameters generally considered the most influential to environmental water quality, including: DO, chlorophyll *a*, nutrient content, seasonal variations in algae or bacterial content, contaminants in water or sediment, and turbidity or water visibility. This section also briefly discusses relevant anthropogenic activities that have in the past, or currently do, impact water quality, including point and nonpoint source pollution discharges, deposition and spills, and pollutants in the water or sediment. The movement of water and currents through the SRWF is described in Section 4.3.1, and geological conditions at the SRWF are described in Section 4.3.2.

Dissolved Oxygen

DO refers to the concentration of oxygen present in water. The source of the DO may be atmospheric or from photosynthesis in aquatic plants, including phytoplankton. Low levels of oxygen (hypoxia) or no oxygen levels (anoxia) can occur when excess organic material, such as that produced during large algal blooms, is decomposed by microorganisms (Long Island Commission for Aquifer Protection [LICAP] 2016).

In May 2006, the EPA and NOAA conducted a joint survey of the Mid-Atlantic Bight to determine ecological conditions, including existing water quality conditions. Results of water sampling events showed DO ranging from 7.7 to 9.7 mg/L on the surface and 8.1 to 9.9 mg/L on the bottom (Balthis et al. 2009). These DO levels were determined to be within the range indicative of good water quality (generally described as greater than 5 mg/L due to fish and fauna life characteristic requirements).

Chlorophyll *a*

Chlorophyll *a* is a pigment used by photosynthetic organisms such as phytoplankton to convert solar energy into organic matter. Concentrations of chlorophyll *a* can be used to determine the amount of phytoplankton present. Excess phytoplankton in an area can lead to overproduction of algae and degraded water quality; therefore, chlorophyll *a* is often used as a metric of water quality health.

CONSTRUCTION AND OPERATIONS PLAN

Site Characterization and Assessment of Impacts – Physical Resources

With the intent of supporting ocean commerce, energy development, and conservation, BOEM and NOAA partnered to create the OceanReports Tool (NOAA n.d.[a]), which generates, among other things, oceanographic and biophysical data for customized locations. In the offshore waters of New York and Rhode Island, the OceanReports Tool provides chlorophyll *a* concentrations obtained from monthly water surface readings over a 10-year period (2007–2016) by the National Aeronautics and Space Administration (NASA) Goddard Space Flight Center (GSFC). These results are included below in Figure 4.3.3-2 (Marine Cadastre 2019). Chlorophyll *a* within offshore waters of New York and Rhode Island over the last 10 years ranged from averages of 0.74 microgram per liter ($\mu\text{g/L}$) in August and September to 2.25 $\mu\text{g/L}$ in April. Chlorophyll *a* concentrations are likely to vary year-to-year due to rainfall and nutrient loading.

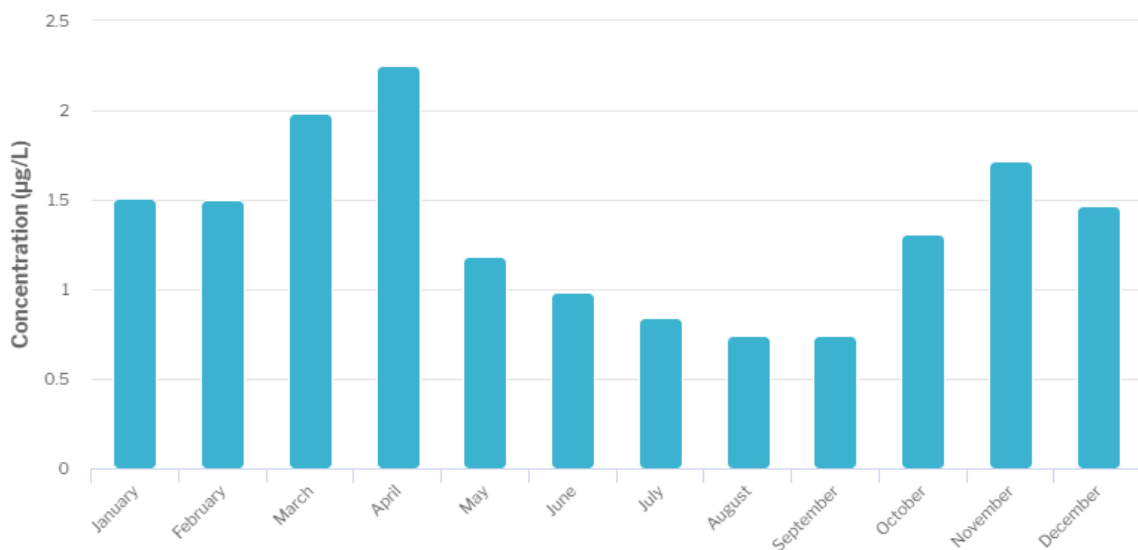

Figure 4.3.3-2 Average Monthly Chlorophyll *a* Concentrations in Offshore New York/Rhode Island Surface Waters from 2007 to 2016 (Marine Cadastre 2019)

CONSTRUCTION AND OPERATIONS PLAN

Site Characterization and Assessment of Impacts – Physical Resources

In 2010, the RI CRMC OSAMP collectively reported chlorophyll *a* concentrations in Block Island Sound and Rhode Island Sound (RI CRMC 2010), and concluded that concentrations were “consistent with oceanic systems and slightly lower than average estimates of phytoplankton production on continental shelves” (RI CRMC 2010). Staker and Bruno (1977) reported chlorophyll *a* concentrations less than 10 µg/L in Block Island Sound, USACE (2004) reported concentrations of 6 to 9 µg/L in Rhode Island Sound, and Nixon et al. (2010) reported concentrations of 0.5 to 1.0 µg/L in Rhode Island Sound. These results showed peak levels of chlorophyll *a* concentrations during late fall and early spring, with reduced levels occurring during summer months (RI CRMC 2010). The results of these sampling events are comparable to those from Marine Cadastre (2019) shown in Figure 4.3.3-2, which are also relatively low (< 3 µg/L). Per the National Coastal Assessment (NCA), chlorophyll *a* concentrations less than 5 µg/L are considered “good” quality, concentrations ranging from 5 to 20 µg/L are considered “fair,” and concentrations greater than 20 µg/L are considered “poor” (EPA 2012). Therefore, chlorophyll *a* concentrations reported by Marine Cadastre (2019) within waters surrounding the SRWF would be considered “good” quality. Results in Block Island Sound reported by Staker and Bruno (1977) and by the USACE (2004) in Rhode Island Sound would be considered “fair” quality. Results by Nixon et al. (2010) in Rhode Island Sound would be considered “good” quality.

Nutrients

Nutrients are chemical elements that all living organisms need for growth and to sustain life. Problems may arise when too much of a particular nutrient is introduced into the environment through human activities (i.e., eutrophication). Freshwaters are more sensitive to excess phosphorus, while in coastal, waters nitrogen is the nutrient of concern. In some cases, nutrients may interact and co-contribute to a water pollution problem (RI DEM 2010).

As part of the Esri Ecological Marine Units Project (Esri n.d.), data on nitrates, phosphates, and silicates were collected from an area that overlaps the SRWF, as shown in Figure 4.3.3-3 (Marine Cadastre 2019). Included in this figure is a customized search polygon, which was run through the Marine Cadastre mapping tool, which identified all nearby sampling locations, which are indicated by the circle symbols. At these sampling locations, nutrient data collected from 1955 to 2012 showed an upward trend for nutrient concentrations as water depths increased. Nutrient concentrations at 3.3-ft (5-m) and 410.1-ft (125-m) depths were: 2.3914 µmol/l to 10.2226 µmol/l (0.2753 to 1.1769 mg/L) for nitrates (Marine Cadastre 2019).

Similarly, Balthis et al. (2009) noted that the results of water sampling in the Mid-Atlantic Bight showed higher levels of nutrients in bottom waters when compared to surface waters. Concentrations of dissolved inorganic nitrogen ranged from 0.01 mg/L to 0.20 mg/L in surface waters and 0.01 to 0.54 mg/L in bottom waters (Balthis et al. 2009). The NCA determined thresholds for dissolved inorganic nitrogen as a means to assess the overall water quality within each US region, including the northeast. Within the northeastern US, dissolved inorganic nitrogen concentrations of greater than 0.5 mg/L were considered “poor,” concentrations from 0.1 to 0.5 mg/L were considered “fair,” and concentrations less than 0.1 mg/L were considered “good” (EPA 2012). Therefore, dissolved organic nitrogen within Mid-Atlantic Bight surface waters as reported by Balthis et al. (2009) would be considered “fair to good” quality, while bottom waters would be considered “poor.”

CONSTRUCTION AND OPERATIONS PLAN

Site Characterization and Assessment of Impacts – Physical Resources

Nutrient concentrations from 1955 to 2012 as reported above by Marine Cadastre (2019) within the waters surrounding the SRWF, would be considered “fair to poor.”

At the sampling locations illustrated in Figure 4.3.3-3, phosphate data from 1955 to 2012 was also reported, and ranged from 0.4167 $\mu\text{mol/l}$ to 0.8485 $\mu\text{mol/l}$ (0.048 to 0.0977 mg/L; Marine Cadastre 2019). Similarly, Balthis et al. (2009) reported dissolved inorganic phosphorus concentrations in Mid-Atlantic Bight surface waters ranging from 0.02 to 0.06 mg/L while bottom water concentrations ranged from 0.02 to 0.12 mg/L. NCA thresholds for dissolved inorganic phosphorus indicate concentrations greater than 0.05 mg/L are considered “poor,” concentrations from 0.01 to 0.05 mg/L are considered “fair,” and concentrations less than 0.01 mg/L are considered “good” (EPA 2012). Per these threshold criteria, phosphorus data collected by Balthis et al. (2009) and phosphorus data reported by Marine Cadastre (2019) within the waters surrounding the SRWF would be considered “fair to poor” (EPA 2012).

As previously stated for chlorophyll *a*, nutrient concentrations are likely to vary throughout the year based on rainfall and nutrient loading within the waterbody.

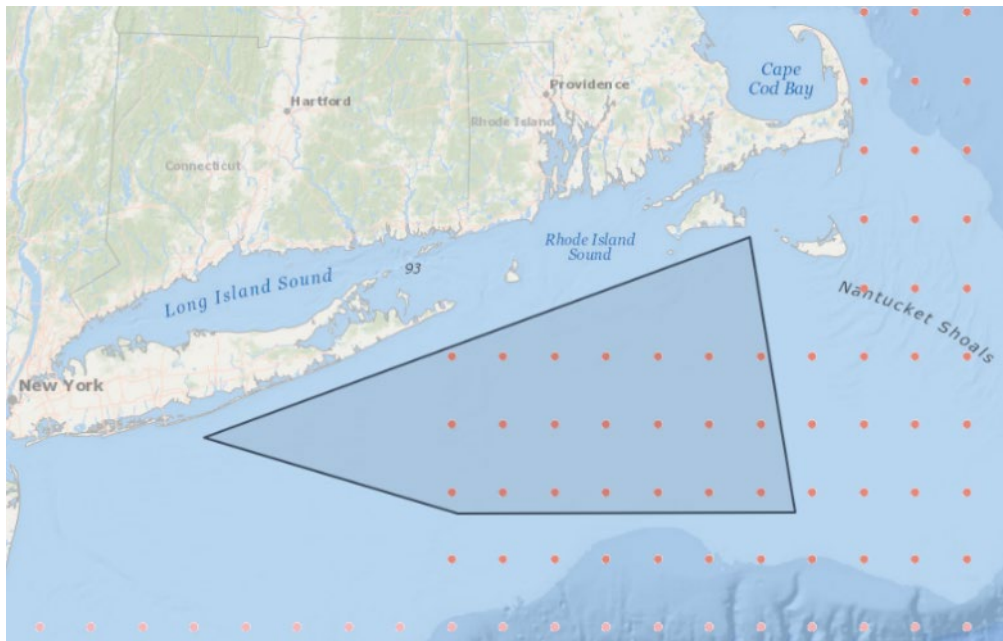

Figure 4.3.3-3 Esri Ecological Marine Units Project Data Collection Locations, 1955-2012

In surface waters, excess nutrients fuel algal blooms, which can lead to water quality degradation. Severe or harmful algal blooms (HABs) can result in the depletion of oxygen in the water column and benthos that aquatic life needs for survival. HABs reduce water clarity, thereby reducing desirable plant growth such as seagrasses, reducing the ability of aquatic life to find food, and clogging fish gills. From Maine to New York, *Alexandrium catenella* is the most common dinoflagellate producing HABs that cause shellfish and finfish kills; however, other HABs known to accumulate along the east coast include *Margoleffidium* sp., *Alexandrium monilatum*, *Aureococcus anophagefferens*, and *Karlodinium* sp. (NOAA n.d.[b]). HABs are more common in coastal marine ecosystems but may still affect open ocean environments.

CONSTRUCTION AND OPERATIONS PLAN

Site Characterization and Assessment of Impacts – Physical Resources

In the most recent State of the Ecosystem Report for the Mid-Atlantic Region, NOAA (2019) reported a trend from 1998 to 2018 of increasing primary production of phytoplankton, likely due to relatively warmer water temperatures, nutrient recycling, and increased bacterial remineralization. In Fall 2018, a phytoplankton bloom was noted in offshore waters, with highest concentrations located near the shelf break (NOAA 2019).

Pathogens

Waterborne pathogens include bacteria, viruses, and other organisms that may cause disease or health problems in native species and in humans. When pathogens are present at elevated concentrations, recreational water use is adversely affected, prompting closures of public beaches and shellfish harvest restrictions.

There are many types of bacteria (such as *Vibrio*) present within the world's oceans, but these typically occur at non-harmful concentrations due to constant flushing via wave and current movement. Vezzulli et al. (2016) found that *Vibrio* concentrations in ocean waters have been increasing due to rising sea surface temperatures.

Along Long Island Sound, surveys from 1993 to 2000 showed no significant increase or decrease in the number of pathogen-related beach closure days (USACE 2015a); however, closure days have been steadily increasing since 2000. As of 2010, there were no documented reports of harmful algal blooms or waterborne pathogen outbreaks in the waters of either Block Island or Rhode Island sounds (RI CRMC 2010).

Contamination

Contamination in offshore US waters can occur from marine vessel spills, discharges (i.e., domestic water, deck drainage, treated sump drainage, ballast water, and bilge water), and/or general trash and debris. Liquid wastes from marine vessels such as sewage, chemicals, solvents, oils, and greases could also be released. Other potential sources of contamination in offshore waters could occur from adjacent coastal cities (i.e., use of pesticides, sewage outfall, dredging operations, harbor/port activity). The addition of any chemical or nutrient to the water column could cause decreases to overall water quality, dependent on the amount and type of contaminant.

Organic contaminants (polychlorinated biphenyls [PCBs] and pesticides) measured in 2001 and 2002 in Rhode Island Sound were generally below method detection limits (USACE 2004). Total PCB concentrations were less than 46 nanograms per liter (ng/L), and total dichlorodiphenyltrichloroethanes (DDTs) were less than 4 ng/L. Dissolved metals' concentrations in Rhode Island Sound were also low, with concentrations generally less than 1 µg/L. Dissolved metals' concentrations were consistent through the year and throughout Rhode Island Sound. Both organic and inorganic pollutant concentrations within the OSAMP area in 2002 were well below RI DEM ambient water quality criteria (RI CRMC 2010).

Similarly, during the joint NOAA and EPA survey in 2006 (Balthis et al. 2009), Mid-Atlantic Bight sediments were determined to be relatively uncontaminated, as no chemicals were found in excess of their corresponding Effects Range Median values, and less than five chemicals were detected at concentrations above corresponding Effects Range Low values (Balthis et al. 2009).

CONSTRUCTION AND OPERATIONS PLAN

Site Characterization and Assessment of Impacts – Physical Resources

EPA Region 2 has mapped ocean disposal sites in the region, which includes the Project Area. EPA's mapped area includes offshore, coastal, and estuarine waters of New York State. Disposal sites near the SRWF are located in Rhode Island Sound, Long Island Sound, and Fire Island Inlet (EPA n.d.[a]). The nearest ocean disposal site is approximately 27.4 mi (23.8 nm, 44.1 km) from the nearest Project component (i.e., the SRWEC Landfall location). No ocean disposal sites are located within the SRWF (EPA n.d.[a]).

Turbidity

Turbidity is the cloudiness or haziness (opacity) of water caused by suspended solids (e.g., sediments or algae) and is measured as the concentration of total suspended solids (TSS in mg/L). Bottom currents may re-suspend silt and fine-grained sands, causing higher suspended particle levels at lower depths. Storm events, particularly frequent, intense storms, may also cause a short-term increase in suspended sediment levels (BOEM 2013). Oceanic waters, generally considered 3 mi (4.8 km) offshore (NYSDEC n.d.[a]), typically have fewer suspended particles and thus lower turbidities. Studies cited by the USACE (2004) showed turbidity in Rhode Island Sound ranged from 0.1 to 7.4 mg/L TSS. Similarly, during the NOAA and EPA 2006 survey previously described, TSS in surface waters were shown to range from 0.9-13.5 mg/L, with bottom waters ranging from 1.1-36.4 mg/L (Balthis et al. 2009).

Anthropogenic Activities

Current anthropogenic activities that are sources of water quality degradation include point source pollution and nonpoint source pollution. Point source pollutants, which enter waterways at well-defined locations such as pipe or sewer outflows, are common sources of water pollution. There are no direct municipal wastewater or industrial point sources into or within the SRWF. Vessels operating in the SRWF area may release discharges that have the potential to impact water quality; these discharges are discussed in Section 4.2.6.

Nonpoint source pollutants are considered the largest contributors to water pollution and water quality degradation. Various land-use practices, such as agriculture, construction activities, urban runoff, and deposition of airborne pollutants, can introduce nutrients, bacterial and chemical contaminants, and sediments, all of which can impact coastal water quality and water resources. New York and Rhode Island likely contribute nonpoint source pollution to coastal waters near the SRWF.

In addition to introduced pollutants, over the past several decades, water temperatures in oceans worldwide have been increasing (Kavanaugh et al. 2017). As temperatures increase over time, the average ocean pH is expected to continue to decline as seawater becomes more saturated with carbon dioxide (Saba et al. 2016). The acidification of ocean water can cause changes to photosynthesis rates, which can impact benthic and fish species distributions (Doney et al. 2009; Feeley et al. 2004). Additional information on increasing worldwide ocean temperatures and resulting pH/acidification as they relate to benthic and fish resources can be found in Section 4.4.2 and Section 4.4.3.

Sunrise Wind Export Cable–OCS

Given the location in offshore waters, the affected environment for water quality along the SRWEC–OCS is expected to be the same as described for the SRWF above.

CONSTRUCTION AND OPERATIONS PLAN

Site Characterization and Assessment of Impacts – Physical Resources

Sunrise Wind Export Cable–NYS

As previously described, the Mid-Atlantic Bight and New York – New Jersey Bight regions will be crossed by the SRWEC as the cable traverses from federal waters into coastal New York State waters, where the cable makes landfall to connect to the Onshore Facilities. The following sections discuss water quality within coastal New York State waters.

Dissolved Oxygen

DO along the Long Island South Shore in 2007, as described in the Coordinated Water Resources Monitoring Strategy (USGS 2016), was deemed by NOAA to be “moderately high,” averaging 8.5 mg/L. The New York – New Jersey Bight (as previously illustrated in Figure 4.3.3-1) has experienced more frequent periods of hypoxia in recent years despite upgrades to wastewater treatment plants and other industrial discharges (NYS 2019).

These hypoxic periods have lowered benthic biodiversity and reduced growth in commercially harvested species (Committee on Natural Resources and Environment 2010).

Chlorophyll a

The OceanReports Tool previously described (NOAA, n.d.[a]) reports higher chlorophyll a concentrations in New York State coastal waters than in offshore waters. Chlorophyll a concentrations in $\mu\text{g/L}$, obtained from monthly water surface readings over a 10-year period (2007–2016) by the NASA GSFC are shown below in Figure 4.3.3-4. Chlorophyll a ranged from 2.69 $\mu\text{g/L}$ in June to 5.38 $\mu\text{g/L}$ in November (Marine Cadastre 2019). As previously stated, the NCA has determined that in northeastern US waters, chlorophyll a concentrations less than 5 $\mu\text{g/L}$ are considered “good,” 5 to 20 $\mu\text{g/L}$ concentrations are considered “fair,” and concentrations greater than 20 $\mu\text{g/L}$ are considered “poor” (EPA 2012). Therefore, chlorophyll a concentrations within the waters surrounding the SRWEC–NYS per the results provided by Marine Cadastre (2019) can be considered “good” with the exception of readings in September and November, which reached “fair” concentration levels.

CONSTRUCTION AND OPERATIONS PLAN

Site Characterization and Assessment of Impacts – Physical Resources

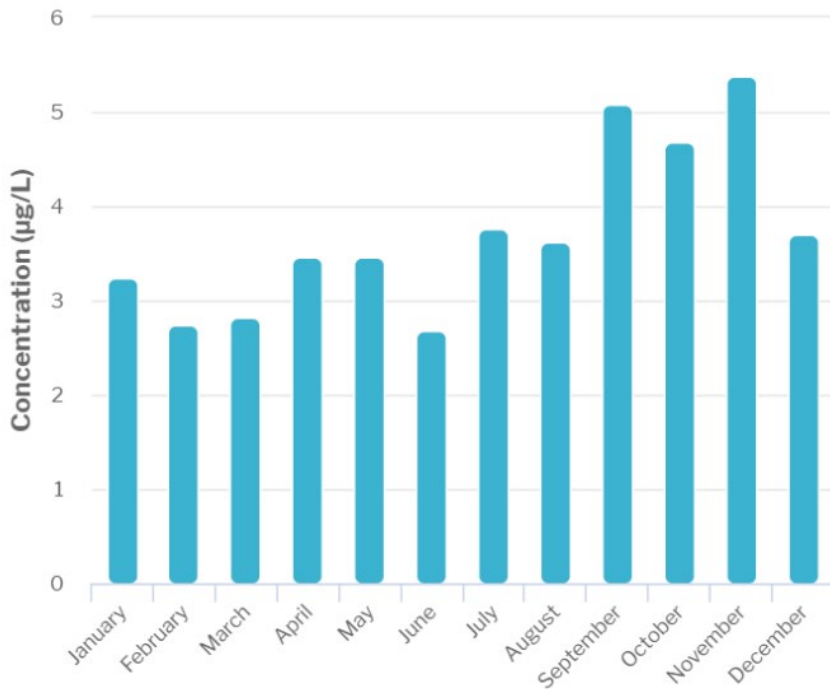

Figure 4.3.3-4 Average Monthly Chlorophyll a Concentrations in Coastal New York Waters from 2007 to 2016 (Marine Cadastre 2019)

Nutrients

As previously described, excessive nutrients in the water can severely impact water quality. Coastal New York State waters experience increased nutrient concentrations due to agricultural and stormwater runoff, wastewater treatment plant discharges, fossil fuels, and improper disposal of fertilizers (NYS 2019; Bricker et al. 1999).

The nearest sewage treatment plant discharge is located offshore of Gilgo Beach, approximately 30.1 mi (26.2 nm, 48.4 km) from the SRWEC–NYS. However, the SRWEC–NYS is not expected to be impacted by that outfall and the SRWEC–NYS does not cross any New York State designated discharge zones (Northeast Oceans Data n.d.).

HABs can occur in coastal and offshore New York waters, as previously described, and the NYSDEC has been monitoring HAB occurrences since 2012 (NYSDEC 2019). HABs within coastal and estuarine waters of New York State are most often caused by *Alexandrium fundyense*, *Cochlodinium polykrikoides*, or *Aureococcus anophagefferens* (NYSDEC n.d.[b]; NYS 2019). HABs in New York State waters are most commonly found in Peconic Estuary, Great South Bay, Northport Bay, Huntington Bay, and Shinnecock Bay (NYS 2019).

CONSTRUCTION AND OPERATIONS PLAN

Site Characterization and Assessment of Impacts – Physical Resources

Pathogens

Every New York State Park beach is sampled at least once a week for bacterial indicators in the water (NYS 2019). For saltwater beaches, samples are tested for *Enterococcus* bacteria, with exceedances over 104 Enterococci colonies per 100 mL considered harmful (NYS n.d.).

The Project crosses Smith Point County Park, and the Robert Moses State Park is also located approximately 15.3 mi (13.3 nm, 24.6 km) from the SRWF. These parks that are nearest to the SRWEC have routinely passed these water quality tests (NYS 2019; SwimGuide 2020).

However, bacteria from stormwater runoff does contribute to many New York waters overall, resulting in historic shellfish bed closures within estuaries of Long Island, the NY/NJ Harbor Estuary, and the New York – New Jersey Bight (NYSDEC 2010). In 2015, Suffolk, Nassau, and Westchester Counties, in addition to New York City coastal beaches, were forced to close or issue advisories for a collective total of 1,457 days; however, no closures or issues have been documented since 2015 (NYS 2019).

Contamination

Long Island Sound (which is hydrologically connected to the Rhode Island Sound and a part of the Mid-Atlantic Bight and New York – New Jersey Bight) has historically received toxic discharges from industrial waste, sewage treatment plants, and contaminated dredged spoils; in 1987 EPA banned these discharges (NYSDEC n.d.[c]). Some pesticides can remain within marine ecosystems for years and may become toxic to benthic organisms through absorption in the sediments.

The New York State Department of Health (NYSDOH) issues fish consumption advisories for areas surrounding Long Island and New York City due to chemical contamination levels known to be harmful to human health (NYS 2019). Contamination advisories have been issued for PCBs, dioxins, cadmium, and mercury levels in fish tissue (NYSDOH 2012).

As previously described, the SRWEC–NYS is included within EPA Region 2 for the mapping of ocean disposal sites, although no ocean disposal sites are located within this region (EPA n.d.[a]). The nearest ocean disposal sites to the SRWEC–NYS are within the boundaries of Rhode Island Sound, Long Island Sound, and Fire Island Inlet (EPA n.d.[a]), located approximately 27.6 mi (24.0 nm, 44.4 km) from the SRWEC–NYS. Sunrise Wind will be collecting sediment samples along the SRWEC–NY to test for the presence of contamination in support of the Article VII application.

Turbidity

Coastal, near-shore waters are expected to have higher suspended particle concentrations and therefore higher turbidity than oceanic waters, which experience a higher flushing rate. From June 2006 to February 2014, 15 dredging project characterizations were completed within the New York – New Jersey Harbor complex (located at the apex of the New York Bight), which included water quality and TSS surveys. Average TSS ambient water samples during this time period ranged from 12.8 to 91.5 mg/L with an average of 30.9 mg/L (USACE 2015b) as compared to reported offshore concentrations previously described that ranged from 0.9 to 36.4 mg/L (Balthis et al. 2009).

CONSTRUCTION AND OPERATIONS PLAN

Site Characterization and Assessment of Impacts – Physical Resources

Anthropogenic Activities

The watersheds encompassing Long Island, New York, have experienced steadily increasing development and population growth with continued residential, commercial, and industrial development. These factors have shaped the area and introduced nutrients, pathogens, and pollutants into nearshore coastal waters, streams, rivers, and intracoastal waterways. Both point and non-point sources of pollution may therefore be present within coastal NYS waters, and the effects of those sources as well as others are discussed above. Also as described above, due to anthropogenic influence, ocean temperatures are increasing, which leads to ocean acidification. The effects of ocean acidification on benthic and fish resources is included in Sections 4.4.2 and 4.4.3.

Onshore Facilities

The onshore components of the Project include the crossing of the ICW and Carmans River . Appendix L – *Onshore Ecological Assessment and Field Survey Report* characterizes waterbodies and wetlands in proximity to onshore components. As detailed in Section 4.4.1, the Onshore Transmission Cable intersects with freshwater and tidal wetlands at a few limited points. These delineated wetlands are described within the Coastal and Terrestrial Habitat Section 4.4.1 and are illustrated within Appendix L.

The following sections discuss water quality within existing surface water resources – the ICW and Carmans River.

Dissolved Oxygen

In the summers of 2016 and 2017, DO concentrations south of Sayville, New York, were reported to be low for sustained periods of time (The Nature Conservancy 2018). Furthermore, three portions of Great South Bay are listed under the most recent New York State 303(d) impaired waterbodies list (NYSDEC 2016) for low DO and nitrogen content. Great South Bay has been listed as impaired since 2010 and total maximum daily loads are in place for these pollutants. Low DO in the bay is attributed to increasingly high levels of nitrogen in the water. Due to the water quality concerns in Great South Bay, DO, salinity, conductivity, nutrients, coliform bacteria, suspended solids, chlorophyll *a*, phytoplankton, temperature, and light transmittance are being monitored up to four times annually by the Suffolk County Department of Health Services (SCDHS) (Suffolk County Government 2020a; SCDHS 2019a). From 2015 through 2019, results from water samples collected at the nearest water monitoring station (station 90100, approximately 106-ft [32-m] from the Onshore Transmission Cable) showed DO concentrations ranging from 3.9 to 12.3 mg/L (SCDHS 2019a, b). The location of this monitoring station (and the station closest to Project components within Great South Bay discussed below) is illustrated within Figure 4.3.3-5.

V:\1956\active_Task Owner and other Non-BC\1956_Jobs\2028113199\03_data\gis_ced\gis\Map\XDC\COP\2028113199_4.3.3-5_WaterQualityMon.mxd Revised: 2021-05-07 By: gearpeniter

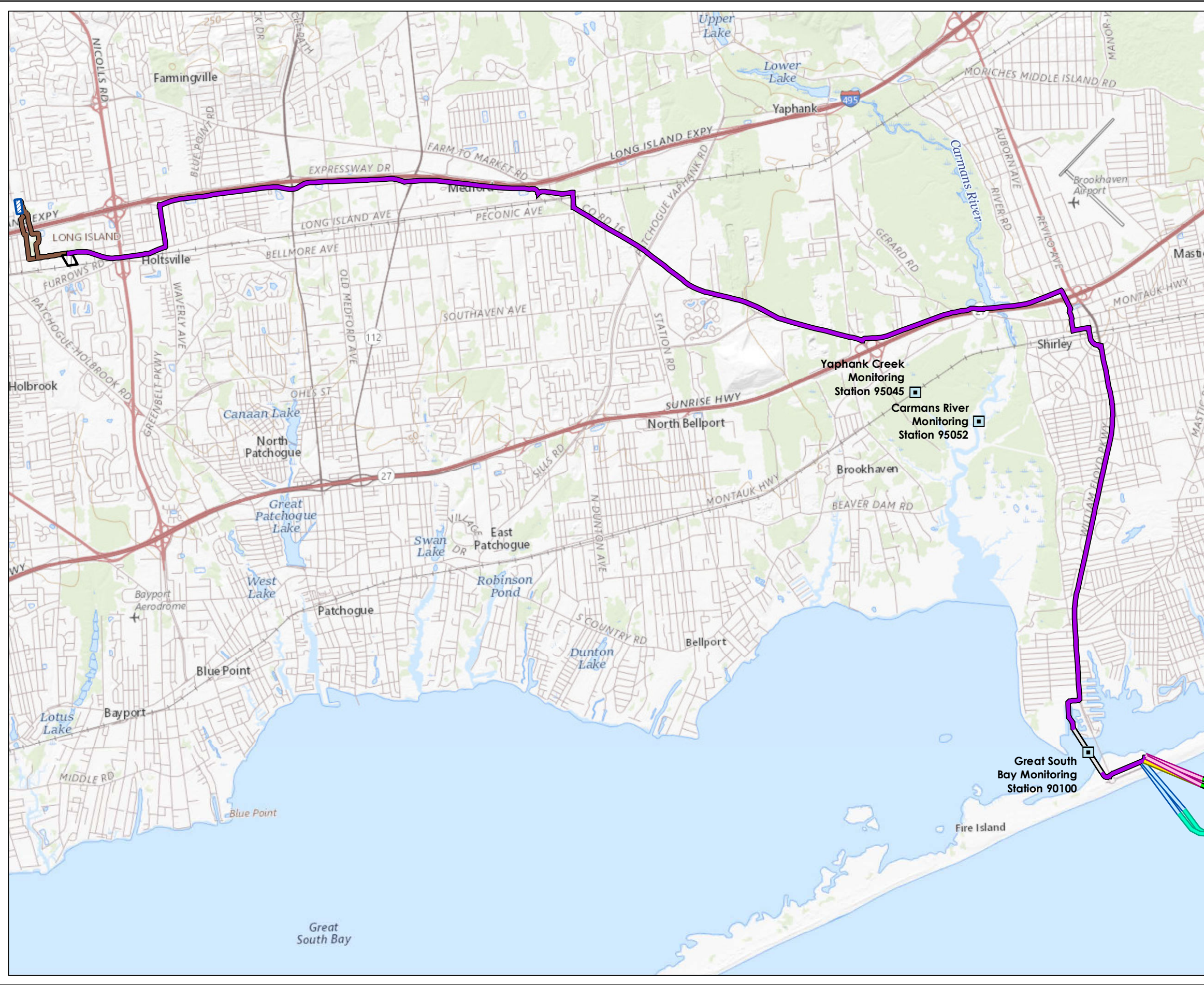

Figure 4.3.3-5
Location of Nearest SC DHS Monitoring
Locations Relative to the Project Area

Sunrise Wind | Powered by **Ørsted & Eversource**

- Legend**
- Sunrise Wind Farm (SRWF)
 - Sunrise Wind Export Cable (SRWEC-OCS)
 - Sunrise Wind Export Cable (SRWEC-NYS)
 - SRWEC-NYS (Western Landfall Option)
 - Landfall HDD A
 - Landfall HDD B
 - Landfall HDD C
 - Intracoastal Waterway HDD (ICW HDD)
 - Onshore Transmission Cable
 - LIE Service Road Route
 - Onshore Interconnection Cable Route
 - Union Avenue Site
 - Holbrook Substation
 - Suffolk County Water Quality Monitoring Station

Note
 Routes are indicative and subject to engineering design changes.

- Sources**
1. Suffolk County Department of Health Services
 2. Base map: USGS The National Map

Date	12/18/2020 Revised: 6/1/2021
Project Number	2028113199
Prepared By	PB
Reviewed By	JK

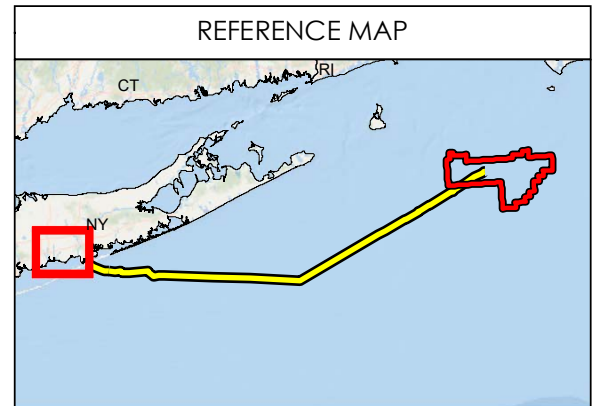
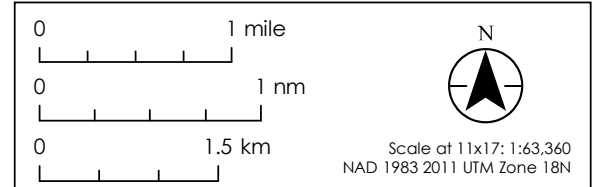

This page intentionally left blank

CONSTRUCTION AND OPERATIONS PLAN

Site Characterization and Assessment of Impacts – Physical Resources

Carmans River is not listed as a 303(d) impaired waterbody (NYSDEC 2016). However, the SCDHS also conducts regular water quality monitoring within the river (among many other stations within the Peconic Estuary and its associated tributaries) for DO, metals, bacteria, organics, and other nutrients. Within Carmans River, the nearest monitoring station to the Onshore Facilities is station 95052, located approximately 1.3 mi (1.2 nm, 2.0 km) from the Onshore Transmission Cable (SCDHS 2019a, b). DO concentrations from samples collected between 2015 and 2019 at this station ranged from 1.3 to 11 mg/L (SCDHS 2019a, b).

Chlorophyll *a*

Chlorophyll *a* levels within Great South Bay, which is crossed by the Onshore Facilities north of the Project Landfall location, have generally been described as 'typical' when compared to other nearby estuaries, with higher concentrations often found from late June through October (NPS 2005). Chlorophyll *a* data collected from the nearest SCDHS Great South Bay water quality monitoring station 90100 (station illustrated on Figure 4.3.3-5) between 2015 and 2019 displayed a wide range of detections. Data showed total chlorophyll *a* concentrations from 0.6 to 44.9 µg/L, with an average of 5.2 µg/L (SCDHS 2019a, b). Similarly, for the same period of time, chlorophyll *a* levels at the Carmans River (also crossed by the Onshore Facilities) water quality monitoring station (905052) ranged from 0.53 to 53.15 µg/L; however, the average concentration, 18.9 µg/L, was relatively higher than the average concentration in Great South Bay (SCDHS 2019a, b). This difference could be related to sample size, as more chlorophyll *a* samples were collected in Great South Bay than Carmans River (49 vs. 7 samples, respectively).

Nutrients

In 2012, Hurricane Sandy made landfall as the largest hurricane in the northeast US's recorded history, causing six sewage spills greater than 100 million gallons into New York City waters (Climate Central 2013). The nearest spill to the Onshore Facilities was in Hewlett Bay Park (approximately 34.6 mi (55.7 km) from the Onshore Interconnection Cable), where roughly 100 million gallons of untreated sewage overflowed into the waterbody (Climate Central 2013). Although this site is more than 30 mi (48.3 km) west of the Onshore Facilities, the waters surrounding Long Island have experienced long-term impacts of increased nutrient levels since Hurricane Sandy. Research shows that 69 percent of the total nitrogen load within Great South Bay is due to septic tanks and cesspools (Kinney and Vaiela 2011; LICAP 2017).

In addition to the sewage spills during Hurricane Sandy, current land use activities in Long Island continue to contribute to increased nutrient levels in both Great South Bay and Carmans River. These land uses include on-site sewage disposal used by Suffolk County residents, stormwater activity, fertilizer seepage, and atmospheric deposition (LICAP 2017).

As part of the previously described SCDHS water quality monitoring program, water samples are tested for nutrients including ammonia, nitrate, nitrite, total nitrogen, total phosphorus, orthophosphate, chloride, and sulfate. Average nutrient concentrations from the nearest Great South Bay SCDHS water quality monitoring station (90100) and the nearest Carmans River water monitoring station (95052) are included below in Table 4.3.3-1.

CONSTRUCTION AND OPERATIONS PLAN

Site Characterization and Assessment of Impacts – Physical Resources

Table 4.3.3-1 Average SCDHS Water Quality Monitoring Station Nutrients Data, 2015–2019

NH ₃ (mg/L)	NO _x (mg/L)	TN (mg/L)	o PO ₄ (mg/L)	TP (mg/L)
Great South Bay Monitoring Station 90100				
0.054	0.083	0.39	0.018	0.064
Carmans River Monitoring Station 95052				
0.073	1.09	1.45	0.012	0.083
SOURCE: SCDHS 2019a, b KEY: NH ₃ = ammonia (filtered) NO _x = nitrite + nitrate (filtered) TN = total nitrogen o-PO ₄ = ortho-phosphate (filtered) TP = total phosphorus				

Pathogens

The high concentration of nutrients in Great South Bay has led to an increase in HABs. Commonly referred to as brown tides, *Aureococcus anophagefferens* blooms have significantly impacted bay scallop populations and eelgrass beds in both Peconic Estuary and Great South Bay (NYSDEC 2019). As such, the SCDHS Office of Ecology, Public Health Related Harmful Algal Blooms (CP8224) project was initiated. This ongoing project involves monitoring HABs within Suffolk County waters to determine their potential impacts on public health (Suffolk County 2020b).

Water samples collected at the SCDHS monitoring stations are tested for total coliform and fecal coliform concentrations. At the nearest monitoring station to the Onshore Facilities, within Great South Bay (90100), the average total coliform concentrations from 2015 to 2019 was 84.8 most probable number (MPN)/100 ml; the average fecal coliforms was 97.7 MPN/100 ml (SCDHS 2019a, b). Comparatively, at the nearest monitoring station to the Carmans River crossing (95052), the average total coliforms from 2015 to 2019 was 1,394.4 MPN/100 ml, with the average fecal coliforms being 212.9 MPN/100 ml.

Contamination

Groundwater quality, regulated by the Suffolk County Water Authority, can be negatively impacted by a variety of anthropogenic activities that result in contamination, including, but not limited to: stormwater runoff and infiltration, spills and releases from commercial and industrial properties, storage tanks, machinery and vehicles, road salt application, fertilizers and pesticides, agriculture, and septic systems. On Long Island, sewage systems and landfills also seep contaminants into groundwater, which can be harmful to human health because groundwater on Long Island is the sole freshwater source (NYS 2019; NYSDEC n.d.[d]).

CONSTRUCTION AND OPERATIONS PLAN

Site Characterization and Assessment of Impacts – Physical Resources

Five active groundwater wells are located in the vicinity of the Onshore Facilities. Four of the five well sites (ID #404806072553802, 404358072520302, 404357072515702, and 404357072515703) are located approximately 0.1 mi (0.2 km) from the Onshore Transmission Cable, and one of the well sites (ID #404642072520001) is located approximately 0.01 mi (0.02 km) from the Onshore Transmission Cable. Water levels in these five active wells nearest to the Onshore Facilities have been categorized as 'normal' and 'above normal' (USGS 2019) and the Project infrastructure is not expected to cross any sensitive source water protection areas.

Data on water-column contaminants in the ICW such as PCBs, polycyclic aromatic hydrocarbons, DDTs, and inorganic concentrations, are limited. However, during EPA surveys in 2005 within Great South Bay (at Station VA-023), sediment contamination levels were analyzed. When compared with the NYS sediment screening benchmarks, results showed that some metals were near, or slightly exceeded, the lowest screening levels (NPS 2005) (for full results, refer to the NPS Technical Report NPS/NER/NRTR—2005/019).

Contaminant concentrations within Carmans River are monitored at the SCDHS Carmans River water quality monitoring station (95052). However, compared to other water quality data provided in previous and subsequent sections, data on organics and metals at this station are limited. Water samples were tested for metals most recently in 2015 and 2016 at the monitoring station nearest to the Onshore Facilities. These results are included in Table 4.3.3-2 below (SCDHS 2019a, b).

Table 4.3.3-2 Metals Detected at SCDHS Carmans River Monitoring Station 95052, 2015–2016

Analyte Name	Units	June 2015	Sept. 2015	Dec. 2015	March 2016	June 2016
Aluminum	ug/L	36.3	9.42	42.9	33.8	11.4
Arsenic	ug/L	--	1.68	1.78	--	3.49
Barium	ug/L	61.8	86.5	206	96.8	99
Calcium	mg/L	13	22	40.6	10.2	15.1
Chromium	ug/L	--	--	1.56	--	--
Copper	ug/L	--	20.5	69.4	7.57	19.2
Iron	mg/l	0.216	0.187	0.134	0.13	0.188
Lead	ug/L	--	--	2.45	--	--
Lithium	ug/L	2.36	6.81	15.2	2.02	3.93
Magnesium	mg/L	12.4	46.1	104.3	9.64	23
Manganese	ug/L	133	81.4	143	120	124
Nickel	ug/L	0.33	0.59	1.06	0.63	0.66
Potassium	mg/L	4.33	14.3	35.4	3.71	7.87
Selenium	ug/L	1.24	4.48	6.61	1.14	4.06
Sodium	mg/l	100	383	859	79.6	190
Strontium	ug/L	101	298	634	91	166
Titanium	ug/L	--	1.09	--	--	--
Zinc	ug/L	15.9	28	95	28.5	30.4

SOURCE: SCDHS 2019a, b

CONSTRUCTION AND OPERATIONS PLAN

Site Characterization and Assessment of Impacts – Physical Resources

Turbidity

Secchi disk depth measurements are taken in association with water quality monitoring samples collected at the SCDHS stations within Great South Bay and Carmans River. A Secchi disk measures water clarity by lowering a black and white disk into the water column until it is no longer visible; the depth at which the disk is last visible is then recorded. From 2015 to 2019, Secchi disk measurements at the Great South Bay monitoring station (90100) ranged from 2 ft (0.6 m) to 8 ft (2.4 m) (SCDHS 2019a, b). In the same timeframe at the Carmans River monitoring station (95052), Secchi disk measurements ranged from 1.5 ft (0.5 m) to 6 ft (1.8 m) (SCDHS 2019a, b).

Anthropogenic Activities

The Atlantic Ocean/Long Island Sound Watershed has experienced continued development and population growth, which has contributed to increased levels of nutrients, pathogens, and pollutants into existing waterbodies. Both point and non-point sources of pollution are present and have been described above.

4.3.3.2 Potential Impacts

Construction, O&M, and decommissioning activities associated with the SRWF, SRWEC, and Onshore Facilities have the potential to cause impacts on water quality. IPFs associated with the construction and O&M phases of the Project are identified on Figure 4.3.3-6 and described separately, by phase, for the SRWF, SRWEC, and Onshore Facilities in the following sections. For the decommissioning phase of the Project, impacts are anticipated to be similar to or less adverse than those described for construction; therefore, impacts from decommissioning are not addressed separately in this section. Supporting information on impacts to existing geological conditions of both the land and seafloor are also presented in further detail in Section 4.3.2 and Appendix H.

CONSTRUCTION AND OPERATIONS PLAN

Site Characterization and Assessment of Impacts – Physical Resources

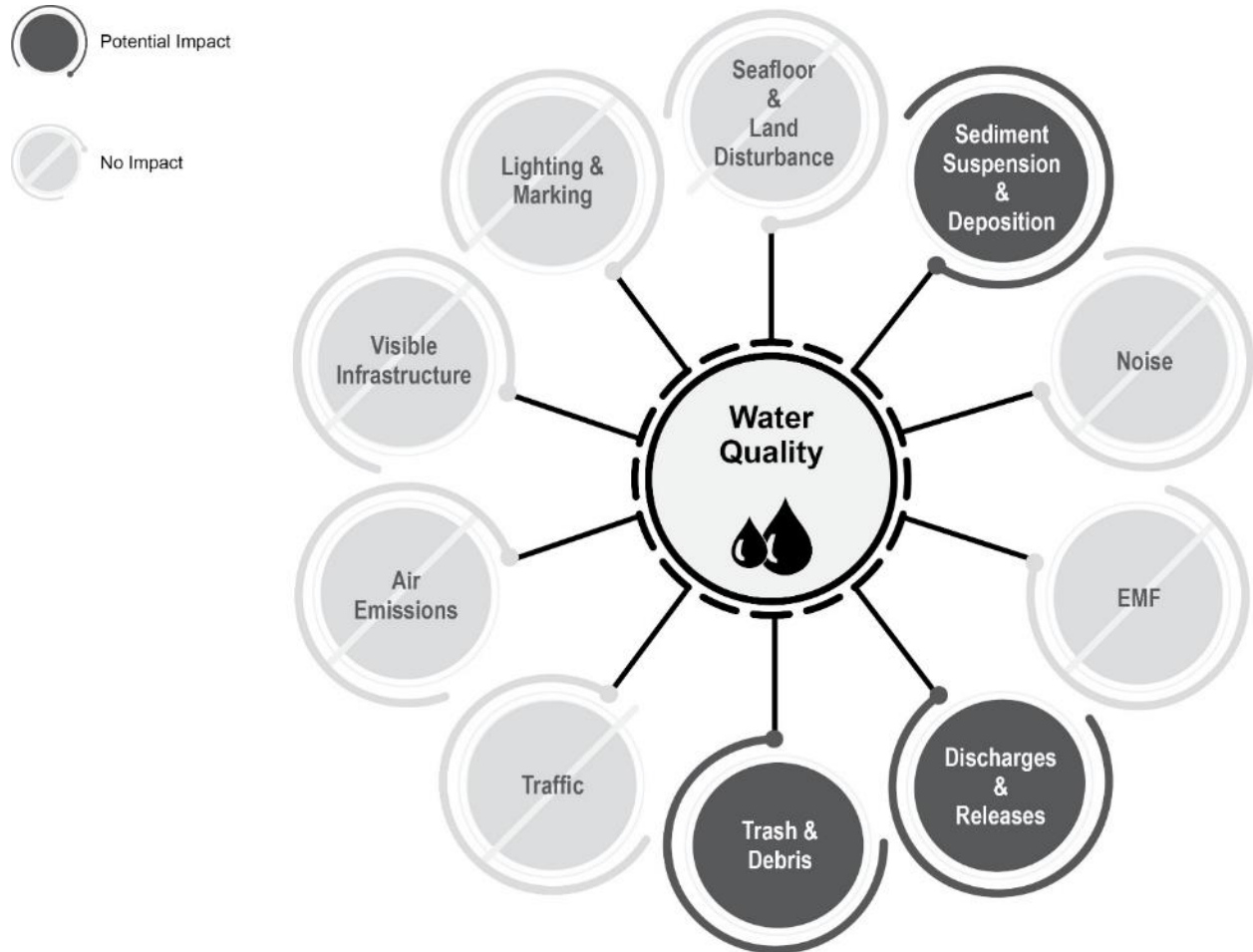

Figure 4.3.3-6 Impact Producing Factors on Water Quality

Sunrise Wind Farm

Based on the IPFs discussed below, construction and O&M of the SRWF are expected to result in direct but temporary impacts to water quality from sediment suspension and deposition, discharges and releases, and trash and debris. These impacts will be minimized to the extent practicable through implementation of the Project BMPs, and are likely to be localized, with water quality returning to pre-existing conditions after in-water activities cease.

CONSTRUCTION AND OPERATIONS PLAN

Site Characterization and Assessment of Impacts – Physical Resources

Construction

Sediment Suspension and Deposition

Seafloor preparation activities are required prior to construction of the SRWF. These activities, as described in Sections 3.3, 4.2.1, and 4.2.2 are likely to include seabed debris clearance (the removal of seabed debris and boulder clearance) where necessary to ensure safe foundation installation. Installation of foundations will occur via either impact or vibratory pile driving, directly disturbing the seafloor where components are placed. Scour protection will be used at the foundation locations. Scour protection includes rock placement, in which large quantities of crushed rock are placed around the location of a foundation structure. The amount of scour protection required will vary for the different foundation types being considered and based on the local site conditions.

Similarly, sediments will be disturbed within the SRWF during installation of IAC and associated cable protection. Installation of the IAC may require dredging via a suction hopper dredge or CFE, which will displace sediments temporarily for installation of the cables. Cable protection required for the IAC would be similar to the cable protection discussed in later sections below for the SRWEC.

In addition to installation of Project components and protection measures, vessels may be required to anchor to the seafloor. Each time an anchor is placed on the seafloor, sediments will be disturbed in the immediate footprint of the anchor. Maximum expected seabed disturbance areas for offshore construction components are provided in Section 3.3.

As previously described in Section 4.3.2, sand waves may be present in the region, which may require leveling; however, within the marine portions of the Project Area, sand waves were only identified within the SRWEC–NYS. Sunrise Wind has taken a conservative approach and assumed that a maximum of 5 percent of the IAC within the SRWF will require sand wave removal prior to cable installation. The actual number will be refined following the results of additional sediment mobility studies. Where required, Sunrise Wind has assumed the route would be cleared of a sand wave swath up to 98 ft (30 m) centered on the final centerline of a distinct export cable. Sand wave levelling will result in increased turbidity due to sediment suspension and deposition.

Sediment suspension and deposition during the construction activities within the SRWF will cause a temporary, localized increase in turbidity. The extent of turbidity will be dependent on sediment type and size as well as the expected duration of the sediment disturbing activities. For example, sediment-disturbing activities in sandy substrates with larger (heavier) particles will typically result in shorter periods of elevated turbidity compared to similar work in areas with greater silt and clay content. Additionally, the longer the disturbance continues, the longer the sediments are expected to be suspended within the water column.

Sediments within the SRWF are a combination of sand, silt, and clay. Appendix H – *Sediment Transport Modeling* provides a technical analysis on estimated suspended sediments from installation of the IAC and from sand wave leveling in offshore, federal waters. Modeling for the IAC installation considered release of 1,800 to 2,750 m³ (2,354 to 3,597 cy) of sediment into the water column over a 3.8-hour duration. Results indicated maximum suspended sediment concentrations in excess of 100 mg/L occurring with the high production rate within 3,346 ft (1,020 m) of the cable route.

CONSTRUCTION AND OPERATIONS PLAN

Site Characterization and Assessment of Impacts – Physical Resources

TSS concentrations were predicted to return to ambient levels (<10 mg/L) within 0.5 hours from completion of the installation. Additionally, the maximum predicted deposition thickness was determined to be 61 mm (2.4 in), and the TSS plume was predicted to be primarily contained within the lower portion of the water column, approximately 12.8-ft (3.9-m) above the seafloor. Sedimentation at or above 10 mm (0.4 in) extends a maximum of 220 ft (67 m) from the cable centerline and covers an area of 3.0 ha (7.4 acres) of the seafloor.

Based on existing sediments at the SRWF, the proposed timeline and duration of the activity, and considering the results of the sediment transport modeling, turbidity from sediment suspension and deposition are expected to be temporary and localized. As illustrated in Appendix H, suspended sediments are predicted to return to pre-existing conditions within 1.5 hours or less after seafloor disturbing activities. Additionally, the regular circulation of water within the SRWF, as discussed in Section 4.3.1, will aid in the flushing of suspended sediments. Environmental measures outlined at the end of this section, such as construction methodologies and BMPs, will further minimize any potential impact to water quality.

Another potential effect from sediment suspension and deposition could include a reduction in water quality from the unintentional release of contamination within sediments. However, as detailed above in the Water Resources Affected Environment, there are no EPA-designated ocean disposal sites overlapping, or immediately adjacent to, the SRWF and no other known sources of contamination are expected to be found within the SRWF. The nearest disposal sites are located within Fire Island Inlet, Long Island Sound, and Rhode Island Sound (EPA n.d.[a]), located approximately 113.9 mi (99.0 nm, 183.3 km) from the SRWF. Also, as previously noted, water sampling in Rhode Island Sound and the Mid-Atlantic Bight showed relatively low contamination levels within offshore waters, and it can be inferred that the sediments within the SRWF are likely to have minimal contamination as well. Therefore, resuspended, contaminated sediments, as a result of construction, are not expected to affect water quality within the SRWF.

Discharges and Releases

Project-related marine vessels operating during construction will be required to comply with regulatory requirements for management of onboard fluids and fuels, including prevention and control of discharges. Trained, licensed vessel operators will adhere to navigational rules and regulations, and vessels will be equipped with spill containment and cleanup materials. Additionally, Sunrise Wind will comply with applicable international (IMO MARPOL), federal (USCG), and state (NY) regulations and standards for reporting treatment and disposal of solid and liquid wastes generated during all phases of the Project. As described in Appendix E1, some liquid wastes will be permitted as discharge into marine waters (i.e., domestic water, deck drainage, treated sump drainage, uncontaminated ballast water, and uncontaminated bilge water); these are not expected to pose an adverse impact to marine resources as they will quickly disperse, dilute, and biodegrade (BOEM 2013).

CONSTRUCTION AND OPERATIONS PLAN

Site Characterization and Assessment of Impacts – Physical Resources

All vessels will similarly comply with USCG standards regarding ballast and bilge water management. Liquid wastes from vessels (including sewage, chemicals, solvents, and oils and greases from equipment) will be properly stored, and disposal will occur at a licensed receiving facility. As required by 30 CFR 585.626, chemicals to be utilized during the Project are provided in Appendix E1, and in Table 3.3.1-2 and Table 3.3.6-2. Any unanticipated discharges or releases are expected to result in minimal, temporary impacts; activities are heavily regulated and unpermitted discharges are considered accidental events that are unlikely to occur. In the unlikely event that a reportable spill were to occur, the National Response Center would be notified, followed by the EPA, BOEM, and USCG, as outlined in Appendix E1.

Trash and Debris

Any active vessel operating within a marine environment has the potential to create trash and debris. However, the discharge or disposal of solid debris into offshore waters from OCS structures and vessels is prohibited by BOEM (30 CFR 250.300) and the USCG (MARPOL, Annex V, Pub. L. 100-220 [101 Stat. 1458]). In accordance with applicable federal, state, and local laws, Sunrise Wind will implement comprehensive measures prior to and during Project construction activities to avoid, minimize, and mitigate impacts related to trash and debris disposal. All trash and debris will be properly stored on vessels for later disposal of on land at an appropriate facility per 30 CFR 585.626(b)(9). Trash and debris will be contained on vessels and offloaded at port or construction staging areas. Food waste that has been ground and can pass through a 25-mm mesh screen may be disposed of according to 33 CFR 151.51-77. All other trash and debris returned to shore will be disposed of or recycled at licensed waste management and/or recycling facilities. Disposal of any other form of solid waste or debris in the water will be prohibited, and good housekeeping practices will be implemented to minimize trash and debris in vessel work areas. These practices will include orderly storage of tools, equipment, and materials, as well as proper waste collection, storage, and disposal to keep work areas clean and minimize potential environmental impacts. With proper waste management procedures, the potential for trash or debris to be inadvertently left overboard or introduced into the marine environment is not anticipated.

Operations and Maintenance

Sediment Suspension and Deposition

As described in Section 3.5, seabed surveys would occur one year after commissioning, 2 to 3 years after commissioning, and 5 to 8 years after commissioning, with the frequency thereafter depending on the findings of the initial surveys, to assess bathymetry and to verify cable burial depth and cable protection measures. Offshore sediment suspension and deposition will result from maintenance activities associated with any maintenance or repair of the WTGs, IAC, and OCS–DC and would also include any required scour protection replenishment. The seafloor will also be disturbed during vessel anchoring while conducting these maintenance activities. The Project will implement environmental protection measures such as construction methodologies and BMPs (as outlined at the end of this section). If non-routine maintenance or emergency repairs are required, these activities would result in only local suspension of sediments and a temporary increase in turbidity at the location of repair.

CONSTRUCTION AND OPERATIONS PLAN

Site Characterization and Assessment of Impacts – Physical Resources

Discharges and Releases

Impacts from accidental discharges and releases during O&M are expected to be similar to, but of lesser likelihood than during construction, as there will be fewer Project-related marine vessels during this phase, and regulatory requirements and preventative measures will still apply. Unpermitted discharges or releases are considered accidental events, and in their unlikely occurrence, these are expected to result in minimal, temporary impacts. Permitted discharges are not expected to pose an adverse impact to marine resources as they will quickly disperse, dilute, and biodegrade (BOEM 2013).

The original coating system on the WTGs is designed to last the lifetime of the structures; therefore, no painting activities are anticipated over the life of the WTGs, other than to repair minor surface damage. Seawater cooling will be needed for the OCS–DC (Section 3.3.6.1). During operation, the OCS–DC will require continuous cooling water withdrawals and subsequent discharge of heated effluent back to the receiving waters. The maximum DIF and discharge volume is 8.1 million gallons per day with actual intake flow (AIF) and discharge volumes that are dependent on ambient source water temperature and facility output. Preliminary hydrodynamic modelling indicates that there will be some highly localized increases in water temperature in the immediate vicinity of the discharge location of the OCS–DC. The design, configuration, and operation of the CWIS for the OCS–DC will be permitted as part of an individual NPDES permit and additional details will be included in the permit application submitted to the EPA. This will include final results of the hydrodynamic modelling.

Anticipated levels of solid and liquid wastes generated by vessel activities during one year of operation, and the disposal and treatment methods, are detailed in Table 3.5.6-1. As a result, O&M activities are expected to result in only temporary and limited impacts to water quality.

Trash and Debris

Impacts from marine disposal of trash and debris during O&M are expected to be similar to, but of lesser likelihood than during construction, as there will be fewer Project-related marine vessels during this phase, and regulatory requirements and preventative measures will still apply. The unanticipated marine disposal of trash and debris is considered an unpermitted, accidental event, and containment and good housekeeping practices will be implemented to minimize the potential.

Sunrise Wind Export Cable–OCS

Construction and O&M of the SRWEC–OCS are expected to result in direct but temporary impacts to water quality from sediment suspension and deposition, discharges and releases, and trash and debris. These impacts are expected to be localized within the area of disturbance and are further discussed below.

CONSTRUCTION AND OPERATIONS PLAN

Site Characterization and Assessment of Impacts – Physical Resources

Construction

Construction and O&M of the SRWEC–OCS are expected to result in direct but temporary impacts to water quality from sediment suspension and deposition, discharges and releases, and trash and debris. These impacts will be minimized to the extent practicable through implementation of the Project BMPs, and are likely to be localized, with water quality returning to pre-existing conditions after in-water activities cease.

Sediment Suspension and Deposition

Sediment suspension and deposition during installation of the SRWEC–OCS will include the following activities: seafloor preparation, cable installation, installation of cable protection, and anchoring vessels. Impacts from seafloor preparation for the installation of the SRWEC–OCS will be similar to impacts previously described for construction of the SRWF. However, within the SRWEC–OCS, Sunrise Wind has assumed that a maximum of 10 percent (compared to the estimated 5 percent of the IAC in the SRWF) of the SRWEC–OCS will require sand wave leveling prior to cable installation. The actual number will be refined following the results of additional sediment mobility studies. Where required, Sunrise Wind has assumed the route would be cleared of sand wave up to 98 ft (30 m) centered on the final centerline of a distinct export cable. Sand wave levelling will result in increased turbidity due to sediment suspension and deposition.

To install the cable, sediments along the cable route will also be disturbed. Installation techniques may include mechanical plowing, jet plowing, dredging, mechanical cutting, and/or backfill plowing, all of which will directly disturb seafloor sediments. Controlled flow excavation or suction hopper dredging may also be used in scenarios where installation to the target burial depth is not achievable using primary installation methodologies. The installation methods and SRWEC–OCS maximum disturbance areas are detailed in Section 3.3.3.

As detailed in Appendix H, sediment transport modeling was completed for the installation of the SRWEC in both offshore and nearshore waters. Prior to modeling, sediments within the SRWEC–OCS were determined to consist of predominantly sand (an average of 83.1 percent of all samples collected) with some fine/silt sediments (an average of 13.2 percent of all samples collected), and minimal gravel (3.7 percent). Installation of the SRWEC–OCS considered the release of 254,360 m³ (332,690 cy) of sediment to the water column over the approximate 94-mi (81.6-nm, 151.3-km) length of the SRWEC route for a duration of 18.7 days. Results indicated maximum suspended sediment concentrations in excess of 100 mg/L occurring within 2,969 ft (905 m). TSS concentrations were then predicted to return to ambient levels (<10 mg/L) within 0.4 hours from completing the installation. The maximum predicted deposition thickness was 789 mm (11.4 in). Sedimentation at or above 10 mm (0.4 in) extended a maximum distance of 791 ft (241 m) from the cable route and covered an area of 336.8 ha (832.3 ac) of the seafloor. Additionally, the TSS plume was predicted to be primarily contained within the lower portion of the water column, approximately 9.8-ft (3.0-m) above the seafloor.

CONSTRUCTION AND OPERATIONS PLAN

Site Characterization and Assessment of Impacts – Physical Resources

The SRWEC is anticipated to be installed primarily by a DP vessel; however, if vessels need to anchor during cable installation, anchoring would occur within the surveyed corridor. Sediment suspension/deposition impacts from anchoring vessels are expected to be minimal, resulting in only temporary, localized turbidity increases. The limited duration of activities expected will result in minimal impacts to water quality. Water quality is expected to revert to pre-existing conditions once construction activities cease, within 0.4 hours per the results of sediment transport modeling provided in Appendix H.

Discharges and Releases

The potential for adverse impacts from routine and non-routine discharges and releases associated with construction of the Project will be similar to those identified for the SRWF. With the implementation of the environmental protection measures such as requiring compliance with regulatory requirements and development of Appendix E1, if an inadvertent release does occur, it is expected to result in temporary impacts to water quality and the appropriate agencies would be notified.

Trash and Debris

The potential for adverse impacts from trash and debris associated with routine and non-routine construction activities for the Project would be similar to those identified for the SRWF. As described for the SRWF, with proper waste management procedures, the potential for trash or debris to be inadvertently left overboard or introduced into the marine environment is unlikely.

Operations and Maintenance

Sediment Suspension and Deposition

O&M of the SRWEC–OCS is expected to have similar impacts to those previously described for the IAC in the SRWF. O&M activities associated with seabed disturbance (including vessel anchoring) would be non-routine events generally associated with maintenance activities such as cable repair and/or scour protection replenishment. Activities would result in local suspension of sediments and thus temporary increases in turbidity. With implementation of the environmental protection measures such as construction methodologies and BMPs, impacts to water quality are expected to be minimal.

Discharges and Releases

Impacts to water quality from marine discharges and releases during O&M are expected to be similar to, but of lesser likelihood than during construction, as there will be fewer Project-related marine vessels during this phase, and regulatory requirements and preventative measures will still apply.

Trash and Debris

As with discharges and releases impacts, impacts to water quality from disposal of trash and debris during O&M are expected to be similar to, but of lesser likelihood than during construction, as there will be fewer Project-related marine vessels during this phase. Regulatory requirements and preventative measures previously stated will still apply to further minimize any potential impacts.

CONSTRUCTION AND OPERATIONS PLAN

Site Characterization and Assessment of Impacts – Physical Resources

Sunrise Wind Export Cable–NYS

Construction

IPFs resulting in potential impacts to water quality from the construction of the SRWEC–NYS will be the same as those previously described above for the SRWEC–OCS. However, in addition to those impacts already described, construction of the SRWEC in NYS waters will require the installation of cable ducts via HDD methodology to land the SRWEC at the Landfall location. The following describes impacts to water quality resulting from HDD construction activities for the IPFs detailed in Figure 4.3.3-6.

Sediment Suspension and Deposition

As previously described, sediments within the SRWEC–OCS were determined to consist of predominantly sand (an average of 83.1 percent of all samples collected) with some fine/silt sediments (an average of 13.2 percent of all samples collected), and minimal gravel (3.7 percent), per Project-specific sediment transport modeling. Modeling of the SRWEC–NYS installation considered the release of 14,481 m³ (18,940 cy) of sediment to the water column for a duration of 20.4 hours using the expected production rate. Results indicate maximum suspended sediment concentrations in excess of 100 mg/L do not occur. TSS concentrations were predicted to return to ambient levels (<10 mg/L) within 0.34 hours from completing the installation. The maximum predicted deposition thickness was 191 mm (7.5 in). Sedimentation at or above 10 mm (0.4 in) extended a maximum of 253 ft (77 m) from the cable route and covered an area of 21.5 ha (53.1 ac) of the seafloor. Additionally, the TSS plume was predicted to be primarily contained within the lower portion of the water column, approximately 8.2-ft (2.5-m) above the seafloor.

Boulder fields, predominantly of medium density, and sand waves were identified in the nearshore area of SRWEC–NYS (Appendix G1). Sunrise Wind has assumed a conservative maximum of 40 percent of the SRWEC–NYS will require sand wave removal prior to cable installation. The actual number will be refined following the results of additional sediment mobility studies. Where required, Sunrise Wind has assumed the route would be cleared of sand waves up to 98 ft (30 m), centered on the final centerline of a distinct export cable.

HDD activities, as described in Section 3.3.3 and illustrated in Figure 3.3.3-4, will occur within nearshore waters. In general, this will involve drilling under the seafloor and the intertidal area using a drilling rig located onshore within the Landfall Work Area. Drilling fluid (comprised of bentonite, drilling additives, and water) is pumped to the drilling head to stabilize the created hole. Drilling fluid is used to prevent a collapse of the hole and to return cuttings to the Landfall drill site. Excavation of exit pits will be within the SRWEC–NYS surveyed corridor.

CONSTRUCTION AND OPERATIONS PLAN

Site Characterization and Assessment of Impacts – Physical Resources

Sediment suspension and deposition will occur due to the HDD and installation of the HDD exit pit, causing increased turbidity. Sediment transport modeling at the HDD exit pit considered the release of 750 m³ (980 cy) of sediment to the water column over the duration of anticipated excavation (63 hours) using a mechanical clamshell dredge. Results indicate that maximum suspended sediment concentrations in excess of 100 mg/L do not occur with the peak TSS concentration reaching 30 mg/L. TSS concentrations were predicted to return to ambient levels (<10 mg/L) within 0.3 hours from completing the excavation. Furthermore, the maximum predicted deposition thickness was 476 mm (18.7 in). Sedimentation at or above 10 mm (0.4 in) extended a maximum of 79 ft (24 m) from the HDD exit pit and covered an area of 0.1 ha (0.25 ac) of the seafloor. The TSS plume was predicted to be primarily contained within the lower portion of the water column, approximately 7.2-ft (2.2-m) above the seafloor.

The increase in turbidity from SRWEC installation, sand wave leveling, and the HDD exit pit will be temporary, with levels returning to pre-existing conditions in less than an hour (per results of sediment transport modeling summarized above) once construction activities cease. Impacts to water quality from sediment suspension and deposition related to installation of the SRWEC–NYS are expected to result in minimal impacts to water quality.

Discharges/Releases and Trash/Debris

The potential for adverse impacts from routine and non-routine discharges, releases, trash, and debris associated with construction of the Project will be similar to those identified for the SRWF and SRWEC–OCS. Additionally, HDD as previously described for Landfall, uses a drilling fluid that consists of bentonite, drilling additives, and water. A barge or jack-up vessel may also be used to assist the drilling process, handle the pipe for pull in, and help transport the drilling fluids and mud for treatment, disposal and/or reuse. To minimize the potential risks for an inadvertent drilling fluid release, an Inadvertent Return Plan will be developed and implemented during construction. Refer to Section 3.3.3.3 for additional details regarding HDD installation and the use of drilling fluids. With the implementation of the environmental protection measures such as requiring compliance with regulatory requirements and development of Appendix E1, if an inadvertent release does occur, it is expected to result in temporary impacts to water quality. With proper waste management procedures, the potential for trash or debris to be inadvertently left overboard or introduced into the marine environment is unlikely.

Operations and Maintenance

IPFs resulting in potential impacts to water quality from the O&M of the SRWEC–NYS will be the same as those previously described for the SRWEC–OCS. Impacts from sediment suspension and deposition and discharges and releases are expected to be temporary and localized, with minimal impacts expected due to trash and debris.

Onshore Facilities

IPFs resulting in potential impacts to water quality in the Onshore Facilities from construction and O&M activities are described below.

CONSTRUCTION AND OPERATIONS PLAN

Site Characterization and Assessment of Impacts – Physical Resources

Construction

Routing for the Onshore Transmission Cable includes crossing the ICW and Carmans River to reach the OnCS–DC. Additionally, the Onshore Transmission Cable route runs parallel to, or intersects with, NWI freshwater and tidal wetlands or NYSDEC State Regulated Freshwater Wetlands at various points. These wetlands are described in Section 4.4.1, and are listed in Table 4.4.1-2. Additionally, habitat evaluations of these features are provided in Appendix L. However, the trenchless construction methods currently proposed are expected to avoid direct impacts to surface waters and wetlands; therefore, no wetlands or ecologically sensitive water resources are expected to be directly impacted by the Project. Additionally, the majority of the work associated with installation of the Onshore Transmission Cable will be conducted within pre-existing roadways. Onshore Project components will cross the previously mentioned Nassau/Suffolk Long Island Sole Source Aquifer, as the aquifer underlies all of Long Island, New York (EPA n.d.[b]).

Sediment Suspension and Deposition

As previously described, the waterbodies crossed by the Project will likely be crossed using trenchless installation methods, which are expected to avoid direct impacts to surface waters and wetlands. These impacts are expected to be temporary, with water quality reverting to pre-existing conditions after construction activities cease. Implementation of applicable permits (detailed in the Section 1.4) and environmental protection measures such as erosion control measures and monitoring procedures during construction, along with relevant state and federal permits for waterbody crossing activities, will further minimize impacts from disturbed sediments within waterbodies.

Discharges and Releases

Although no impacts from discharges and releases are anticipated, spills or accidental releases of fuels, lubricants, or hydraulic fluids could occur during use of trenchless installation and duct bank installation methods, installation of the Onshore Transmission Cable or Onshore Interconnection Cable, or during construction activities at the OnCS–DC. An SPCC Plan will be developed and any discharges or release will be governed by NYS regulations. Additionally, where HDD is utilized, an Inadvertent Return Plan will be prepared and implemented to minimize the potential risks associated with release of drilling fluids. Any unanticipated discharges or releases within the Onshore Facilities during construction are expected to result in minimal, temporary impacts; activities are heavily regulated, and discharges and releases are considered accidental events that are unlikely to occur.

Trash and Debris

Good housekeeping practices will be implemented to minimize trash and debris in onshore work areas. These practices will include orderly storage of tools, equipment, and materials, as well as proper waste collection, storage, and disposal to keep work areas clean and minimize potential environmental impacts. All trash and debris returned to shore from offshore vessels will be properly disposed of or recycled at licensed waste management and/or recycling facilities. Disposal of any solid waste or debris in the water will be prohibited. With proper waste management procedures, the potential for trash or debris to be inadvertently introduced onto an onshore area is unlikely.

CONSTRUCTION AND OPERATIONS PLAN

Site Characterization and Assessment of Impacts – Physical Resources

Operations and Maintenance

The Onshore Facilities have minor maintenance needs, which will be performed under a routine preventative maintenance plan in accordance with manufacturer requirements and industry guidelines. This plan will be created during the Project execution and construction period. Routine maintenance required during the lifespan of the Onshore Facilities will primarily involve observation and testing of equipment. Impacts are expected to be significantly less than those described for the construction phase. Additional details regarding potential impacts to water quality are described in the sections below.

Sediment Suspension and Deposition

In the event of a fault or failure of the onshore cable, sediment suspension and deposition impacts would be similar to those described for the construction phase if the fault or failure occurred at or near a wetland or waterbody crossing. However, should surface disturbances be required within or within close proximity of wetland or waterbody locations, environmental protection measures will be implemented, such that impacts to resource locations are expected to be temporary and minimal.

Discharges and Releases

The OnCS–DC will require various oils, fuels, and lubricants to support its operation, and SF₆ gas will also be used for electrical insulating purposes. As described above in the construction section, accidental discharges, releases, and disposal could indirectly cause habitat degradation, but risks will be avoided through implementation of the measures described in the SPCC.

Trash and Debris

Solid waste and other debris will be generated predominantly during Project construction activities but may also occur during O&M of the Onshore Facilities. With the implementation of proper waste management procedures, and adherence to regulations, the potential for trash or debris to be inadvertently introduced onto an onshore area is unlikely.

4.3.3.3 Proposed Environmental Protection Measures

Sunrise Wind will implement the following environmental protection measures to reduce potential impacts on water quality. These measures are based on protocols and procedures successfully implemented for similar projects.

- Accidental spill or release of oils or other hazardous materials will be managed offshore through an Emergency Response Plan/Oil Spill Response Plan (ERP/OSRP) and onshore through a Spill Prevention, Control, and Countermeasure (SPCC) Plan.
- Sunrise Wind will require all construction and O&M vessels to comply with applicable International Convention for the Prevention of Pollution from Ships (IMO MARPOL), federal (USCG and EPA), and state regulations and standards for the management, treatment, discharge, and disposal of onboard solid and liquid wastes and the prevention and control of spills and discharges.
- Where HDD is utilized, an Inadvertent Return Plan will be prepared and implemented to minimize the potential risks associated with release of drilling fluids.

CONSTRUCTION AND OPERATIONS PLAN

Site Characterization and Assessment of Impacts – Physical Resources

- Onshore construction activities will be conducted in compliance with the New York State Pollutant Discharge Elimination System (SPDES) General Permit for Stormwater Discharges associated with construction activities, and an approved SWPPP.
- An SWPPP, including erosion and sedimentation control BMPs and revegetation measures, will be implemented to minimize potential water quality impacts from construction and O&M of the Onshore Facilities.

4.3.4 Air Quality

This section describes the affected environment as it relates to air resources and potential air emissions from the construction and operation of the Project and discusses the expected CAA and NEPA review. The discussion of the affected environment for air quality is followed by an evaluation of potential Project-related impacts based on the projected emissions, and a description of the environmental protection measures that Sunrise Wind will implement to avoid, minimize, and mitigate potential impacts to air quality. Once the Project is operational, the electricity generated by the SRWF will reduce the need for electricity generation from traditional fossil fuel powered plants that emit air pollutants and greenhouse gases. As a result, the avoided emissions resulting from the Project will provide a net benefit in terms of air quality. A quantitative analysis of total avoided air emissions is provided in Section 4.3.4.3. Based on the results of this analysis, the Project is expected to displace significant emissions of pollutants produced by suppliers to the electric grid and decrease the contribution of greenhouse gases (GHG) from these sources. The avoided emissions (in tons) of carbon dioxide (CO₂), methane (CH₄), nitrous oxide (N₂O), NO_x, and sulfur dioxide (SO₂) from fossil fuel generation over an annual and a 25-year period are summarized in Table 4.3.4-1 below.

Table 4.3.4-1 Emissions Avoided by Construction of the Project (tons) for Various Pollutants

Avoided Emissions	Power Generated (MW hours)	CO ₂	CH ₄	N ₂ O	NO _x	SO ₂
Maximum Annual	3,854,400	2,592,802	85	11	1,474	1,534
Maximum over 25 years	96,360,000	64,820,041	2,112	275	36,857	38,351

The description of the affected environment and assessment of potential impacts to air quality were developed by reviewing current federal and state air quality regulations applicable to the Project, public data sources related to air quality including online mapping databases (e.g., EPA's Green Book), and consultation with air permitting staff at EPA. Specific requirements for submittal of air quality information within this COP are provided in 30 CFR §585.659, which directs COP submittals to follow the regulations in 40 CFR §55–Outer Continental Shelf Air Regulations.

The CAA requires the EPA to identify air pollutants that pose a risk to public health and welfare and to set standards indicating the permissible air concentration of each pollutant. The EPA has identified six pollutants of concern, termed “criteria pollutants”: CO, lead (Pb), nitrogen dioxide (NO₂), O₃, PM, and SO₂. These six pollutants (CO, Pb, NO₂, ozone, PM, and SO₂) are referred to as “criteria pollutants” since the EPA develops criteria, or science-based guidelines, for these pollutants when it sets standards. Ozone is not emitted directly into the air but is created by chemical reactions in the atmosphere between NO_x and VOC in the presence of sunlight.

CONSTRUCTION AND OPERATIONS PLAN

Site Characterization and Assessment of Impacts – Physical Resources

Primary PM is emitted directly into the atmosphere by anthropogenic activities that stir up dust from the ground or create smoke and ash through combustion (e.g., vehicle exhaust), while secondary PM is formed in the atmosphere as a result of chemical reactions between gaseous emissions such as SO₂ and NO₂. The EPA sets primary and secondary standards called National Ambient Air Quality Standards (NAAQS) for the pollutants, which are summarized in Table 4.3.4-2. Primary standards provide public health protection, including protecting the health of "sensitive" populations such as asthmatics, children, and the elderly. Secondary standards provide public welfare protection, including protection against decreased visibility and damage to animals, crops, vegetation, and buildings.

Table 4.3.4-2 National Ambient Air Quality Standards for Criteria Pollutants

Criteria Pollutant	Primary/Secondary	Averaging Time	Standard	
			Concentration	Form
CO	Primary	8 hours	9 ppm	Not to be exceeded more than once per year
		1 hour	35 ppm	
Pb	Primary	1 hour	100 ppb	98 th percentile of 1-hour daily maximum concentrations, averaged over 3 years
	Primary and Secondary	1 year	53 ppb	Annual mean
NO ₂	Primary	1 hour	100 ppb	98 th percentile of 1-hour daily maximum concentrations, averaged over 3 years
	Primary and Secondary	1 year	53 ppb	Annual mean
O ₃	Primary and Secondary	8 hours	0.070 ppm	Annual fourth highest daily maximum 8-hour concentration, averaged over 3 years
PM _{2.5}	Primary	1 year	12 µg/m ³	Annual mean, averaged over 3 years
	Secondary	1 year	15 µg/m ³	
	Primary and Secondary	24 hours	35 µg/m ³	98 th percentile, averaged over 3 years
PM ₁₀	Primary and Secondary	24 hours	150 µg/m ³	Not to be exceeded more than once per year on average over 3 years
SO ₂	Primary	1 hour	75 ppb	99 th percentile of 1-hour daily maximum concentrations, averaged over 3 years
	Secondary	3 hours	0.5 ppm	Not to be exceeded more than once per year

In an effort to achieve and maintain the federal standards, each state is required to monitor the ambient air to determine whether the state or area is in compliance. Therefore, baseline air quality conditions are typically evaluated by comparing the ambient concentration of a criteria pollutant, as measured at the nearest air monitoring station, to the NAAQS to determine whether the ambient concentration is in exceedance of any of the criteria pollutant standards.

CONSTRUCTION AND OPERATIONS PLAN

Site Characterization and Assessment of Impacts – Physical Resources

Based on the monitoring data, the EPA designates individual counties and multi-county metropolitan areas of a state as in nonattainment, attainment, or maintenance for the standard. Nonattainment means that the county and/or area is not meeting the standard, while attainment means that it is. Maintenance means that it has only more recently begun to meet the standard and must continue to provide EPA with information showing that it is maintaining the standard before the area can qualify for re-designation as attainment.

Certain areas that cannot be designated as either attainment or nonattainment based on available information are considered to be “unclassifiable,” and such areas are typically treated as in attainment. For each area that is designated as nonattainment, state and local air quality management agencies must develop a State Implementation Plan (SIP) to attain the standard. The SIP includes regulations for reducing emissions of the pollutant, quantifying the levels of emissions from various sources, and permitting emissions sources.

The primary regulatory mechanism for attaining and maintaining the NAAQS is the requirement that air emission sources obtain an air permit prior to construction and operation. The permitting process considers the nature, location, and magnitude of potential emissions from the source and is designed to help attain and maintain the NAAQS. An emissions inventory is developed to characterize potential emissions and to determine if Project emissions might exceed the “major source” thresholds. If that is determined to be likely, the Project would be subject to the New Source Review (NSR) and Prevention of Significant Deterioration (PSD) provisions of the CAA. Permitting of NSR/PSD sources may involve air quality modeling, baseline air quality monitoring and demonstration of Lowest Achievable Emission Rate (LAER) for nonattainment areas, and Best Available Control Technology (BACT) for PSD sources. Air permits issued by the regulatory agency at the conclusion of the permitting process might contain conditions and limits on construction and operation. In the case of offshore wind farms on the OCS, the permitting requirements are contained in 40 CFR Part 55. In addition, in the case of federal actions, the General Conformity Rule ensures that the federal actions do not interfere with a state’s implementation plans to attain and maintain NAAQS. Permitting and General Conformity requirements are discussed below in greater detail.

4.3.4.1 Affected Environment

Regulatory Setting

Outer Continental Shelf Air Permitting

Under the authority of the CAA, the EPA regulates air quality on the OCS, including emissions from the construction and O&M of OCS sources. Section 328 (a)(4)(c) of the CAA defines an OCS source as any equipment, activity, or facility that emits, or has the potential to emit, any air pollutant; is regulated or authorized under the *OCS Lands Act*; and is located on the OCS or in or on waters above the OCS. This definition includes vessels only when they are permanently or temporarily attached to the seabed and erected thereon and used for the purpose of exploring, developing, or producing resources therefrom (40 CFR § 55.2). In this case, the OCS sources include any equipment (e.g., diesel generators) on the WTGs and OCS-DC to the extent that they have a potential to emit, as well as any construction or O&M activities if the vessel is attached to the seabed and erected thereon and is used for the purpose of developing the SRWF (WTGs, OCS-DC, and IAC) and/or the SRWEC-OCS.

CONSTRUCTION AND OPERATIONS PLAN

Site Characterization and Assessment of Impacts – Physical Resources

For permitting purposes, emissions from vessels servicing or associated with the OCS source are considered direct emissions from the OCS source while at the source, and while en route to or from the source when within 25 mi (21.7 nm; 40.2 km) of the centroid of the source, and must be included in the “potential to emit” for the OCS source (40 CFR § 50.2). Therefore, for the OCS air permit application, the OCS emission inventory (Appendix K) includes anticipated emissions from vessels associated with the Project while operating at OCS source(s) or within 25 mi (21.7 nm; 40.2 km) of the sources (Figure 4.3.4-1), as well as stationary sources within this area, including backup generators on each of the WTGs. If the SRWEC–OCS is regulated as a separate OCS source, separate inventories will be presented for the SRWF and the SRWEC–OCS.

The permitting authority for the OCS air permit would be dictated by the COA for an OCS source. The nearest onshore area (NOA) is typically the COA, unless another area that meets certain requirements requests to become the COA and the EPA agrees after a public comment period (as per the rules for designating a COA in 40 CFR Part 55.5). Sunrise Wind’s Notice of Intent to submit an application must identify the NOA (40 CFR Part 55.4).

If the potential estimated emissions from construction and operation of OCS sources at the SRWF or SRWEC exceed the applicable major source permitting thresholds for one or more of the criteria pollutants, or for NO_x or VOCs, which contribute to the formation of ozone (one of the criteria pollutants), it is expected that one or both of these would require a major source permit under the Nonattainment New Source Review (NNSR) and/or PSD regulations. Decommissioning emissions, likely to occur 25 to 35 years in the future, would be the subject of a separate permit application. A new source can be subject to NNSR for one or more pollutants, and PSD for other pollutants.

NNSR regulations apply to sources in ozone nonattainment areas and in the ozone transport region, which have the potential to emit more than 50 tons per year (tpy) VOCs or 100 tpy of NO_x. (VOCs and NO_x are both precursors of ozone, which forms in the atmosphere as a result of chemical reactions between VOCs and NO_x in the presence of sunlight.) Such sources are required to use control technology equivalent to LAER and to obtain emission offsets such that there is a net air quality benefit. For moderate ozone nonattainment areas, the ratio of total actual emissions reductions of VOC or NO_x to total allowable increased emissions is effectively 1.26 to 1, when a five percent buffer is included. The regulations also require a public review and comment period. NNSR regulations do not require an air quality analysis.

The PSD regulations apply to sources with potential emissions in excess of 250 tpy or more of any air pollutant, and which may impact attainment or unclassifiable areas. PSD review is triggered if potential to emit for criteria pollutants such as NO₂ exceeds the major source threshold. Such sources are required to use control technology equivalent to BACT, and to conduct an air quality analysis. The purpose of the air quality analysis is to demonstrate that the new emissions will not cause or contribute to a violation of any applicable NAAQS or the allowable “increment” (or increase in air quality concentrations) in the area. Air quality dispersion modeling is typically conducted as part of the air quality analysis; the use of the EPA’s Offshore and Coastal Dispersion Model is required to determine the impact of offshore emissions on air quality of coastal regions, unless the EPA approves a proposal for another modeling approach (e.g., AERMOD, input data from the prognostic model, etc.).

CONSTRUCTION AND OPERATIONS PLAN

Site Characterization and Assessment of Impacts – Physical Resources

PSD regulations also require additional impact analyses to assess impacts on soils, vegetation, and visibility. Public involvement, including public review and a comment period, is also part of the process.

Permitting other than OCS Air Permitting

Vessel emissions would occur during transit to and from one or more ports and while vessels are in port during the construction phase. Following construction, Onshore Facilities may be used to support O&M activities. At this time, the location and extent of those activities, along with the potential need for an air emission permit (by the facility operator or SRWF), is not known.

In addition, air permits might be required for stationary onshore emission sources (e.g., emergency generators) at Onshore Facilities associated with the OnCS–DC, Onshore Transmission Cable, and Onshore Interconnection Cable. These permits are expected to be minor (unlike the OCS air permit, which is expected to be a major source permit, as discussed above). Generally, no permits are needed for mobile sources and marine vessels traveling through state waters. However, emissions from these stationary onshore sources have to be accounted for in the General Conformity analysis (see next section below).

General Conformity

In addition to the information specifically provided to support the air permits, other estimated air emissions are included in the COP to allow for BOEM's assessments to fulfill its NEPA and CAA obligations. Under NEPA, BOEM will assess Project-related impacts to air quality. Under the CAA, BOEM is obligated to make a general conformity determination based on 40 CFR §51, Subpart W, and Part 93, Subpart B, entitled "Determining Conformity of General Federal Actions to State or Federal Implementation Plans." The General Conformity Rule applies to all federal actions except highway and transit programs. Title I, Section 176(c)(1) of the CAA defines conformity as the upholding of "an implementation plan's purpose of eliminating or reducing the severity and number of violations of the NAAQS and achieving expeditious attainment of such standards." Therefore, BOEM's approval of the COP, and associated air pollutant emissions, should not cause or contribute to new violations of NAAQS; increase the frequency or severity of any existing violation of the NAAQS; or delay timely attainment of the NAAQS or interim emission reductions.

Before determining whether the General Conformity Rule is applicable, BOEM first must estimate direct and indirect emissions of criteria pollutants as well as VOCs and NO_x from the Project, excluding those emissions already accounted for in the OCS Permit. General Conformity air emissions include onshore emissions (such as those from the OnCS–DC) and those within 3.45 mi (3 nm; 5.6 km) of the shore (within state jurisdiction), but outside the 25-mi radius from the centroid. If the estimated emissions for each pollutant are less than the applicable *de minimis* thresholds presented in Table 4.3.4-3 and Table 4.3.4-4 for nonattainment and maintenance areas, respectively, the General Conformity Rule does not apply. In addition to the criteria pollutants, the thresholds also include VOCs and NO_x, which can react in the atmosphere to form ozone.

Direct emissions are defined as "those emissions of a criteria pollutant or its precursors that are caused or initiated by the Federal action and originate in a nonattainment or maintenance area and occur at the same time and place as the action and are reasonably foreseeable" (40 CFR Part 93.152). Emissions associated with the construction and O&M of the SRWEC–NYS and Onshore Facilities would be direct emissions.

CONSTRUCTION AND OPERATIONS PLAN

Site Characterization and Assessment of Impacts – Physical Resources

For the SRWF and SRWEC, emissions associated with Project vessel transit through state waters outside of the 25-mi OCS area during construction and O&M would also be included in the General Conformity analysis as direct emissions.

Indirect emissions are defined (in 40 CFR Part 93.152) as “those emissions of a criteria pollutant or its precursors:

- That are caused or initiated by the federal action and originate in the same nonattainment or maintenance area but occur at a different time or place as the action;
- That are reasonably foreseeable;
- That the agency can practically control; and
- For which the agency has continuing program responsibility.”

Table 4.3.4-3 de minimis Emission Thresholds for Determining Clean Air Act Conformity in Nonattainment Areas

Criteria Pollutant	Tons Per Year (tpy)
40 CFR §93.153(b)(1) – For purposes of paragraph (b) of this section the following rates apply in nonattainment area (NAAs):	
Ozone (volatile organic compounds or oxides of nitrogen):	
Serious NAAs	50
Severe NAAs	25
Extreme NAAs	10
Other ozone NAAs outside an ozone transport region	100
Other ozone NAAs inside an ozone transport region:	
VOC	50
NO _x	100
CO: All NAAs	100
SO ₂ or NO ₂ : All NAAs	100
Particulate Matter smaller than 10 microns (PM₁₀):	
Moderate NAAs	100
Serious NAAs	70
Particulate matter smaller than 2.5 microns (PM_{2.5}) (direct emissions, SO₂, NO_x, VOC, and ammonia):	
Moderate NAAs	100
Serious NAAs	70
Pb: All NAAs	25

CONSTRUCTION AND OPERATIONS PLAN

Site Characterization and Assessment of Impacts – Physical Resources

Table 4.3.4-4 de minimis Emission Thresholds for Determining Clean Air Act Conformity in Maintenance Areas

Criteria Pollutant	Tons Per Year (tpy)
40 CFR §93.153(b)(2) – For purposes of paragraph (b) of this section the following rates apply in maintenance areas:	
Ozone (NO _x), SO ₂ , or NO ₂ : All Maintenance Areas	100
Ozone (VOCs):	
Maintenance areas inside an ozone transport region	50
Maintenance areas outside an ozone transport region	100
CO: All maintenance areas	100
PM ₁₀ : All Maintenance areas	100
PM _{2.5} (direct emissions, SO ₂ , NO _x , VOC, and ammonia): All maintenance areas	100
Pb: All maintenance areas	25

Emissions from the vehicular or vessel traffic associated with workers traveling to the SRWF or to Onshore Facilities and ports would be considered as direct emissions (other than those within 25 mi [21.7 nm; 40.2 km] of the Project that are covered by the OCS permit).

If the total emissions (direct and indirect) exceed the listed thresholds, the regulations require a determination (prior to implementation of the action) that the emissions will not interfere with or delay attainment and/or maintenance of NAAQS under the applicable SIP. This may require further air quality analyses and/or the purchase of offsets.

There are certain exemptions to the General Conformity requirements. General Conformity determination is not required for a federal action (or portion thereof) that requires a permit under the NNSR or PSD programs. Therefore, portions of the Project that are subject to NNSR or PSD permitting (i.e., the OCS source(s), since the potential emissions from the OCS source(s) will likely exceed the major source permitting thresholds) will be exempt from the General Conformity requirements.

Hazardous Air Pollutants (HAPs) and Greenhouse Gases (GHGs)

In addition to the criteria pollutants discussed above, air pollutants can be categorized as Hazardous Air Pollutants (HAPs) or GHGs. HAPs, also known as toxic air pollutants or air toxics, are those pollutants known or suspected to cause cancer or other serious health impacts, such as reproductive impacts or birth defects, or adverse environmental impacts (EPA 2017). Examples of HAPs include benzene (found in gasoline), dioxin, asbestos, toluene, cadmium, mercury, and chromium.

CONSTRUCTION AND OPERATIONS PLAN

Site Characterization and Assessment of Impacts – Physical Resources

There are no federal ambient air quality standards for HAPs. Emissions of HAPs are regulated through the National Emission Standards for Hazardous Air Pollutants and permit requirements. The standards depend on the type of manufacturing activity and whether or not the regulated facility is a “major source,” which is defined as a source that has actual or potential emissions of 10 tpy or more of any specific HAP or 25 tpy or more of any combination of HAPs.

GHGs are gases that trap heat in the atmosphere and include CO₂, CH₄, N₂O, and fluorinated gases, such as SF₆. The largest source of GHG emissions from human activities in the US is from burning fossil fuels (mostly coal and natural gas) for electricity, heat, and transportation. Emissions of GHGs from major stationary sources are regulated under the PSD and the Title V Operating Permit Programs; specifically, for sources subject to PSD due to emissions of non-GHG pollutants, if the GHG emissions exceed 75,000 tpy on a Carbon Dioxide Equivalent (CO₂e) basis, BACT is required for GHG emissions. Regulations in 40 CFR §Part 98 require certain GHG emitters to report their GHG emissions so that individual states can produce an annual GHG emissions inventory. There are no federal ambient air quality standards or emission standards for GHGs.

The Affected Environment section below provides a regional overview of the affected environment as it relates to air resources in the Project Area. Potential emissions from the Construction and O&M phases of the Project for SRWF, SRWEC, and Onshore Facilities are described in the Potential Impacts section, along with the expected CAA review (permitting and General Conformity). The methodology and detailed results of the Project's air emissions inventory are included in Appendix K.

Criteria Pollutants

According to EPA's Green Book, which provides the NAAQS attainment status for each state and/or county in the country, Albany County, NY, all of Rhode Island, Bristol County, Massachusetts, and Norfolk County, Virginia, are attainment areas for all criteria pollutants. Suffolk County, New York, and Gloucester County, New Jersey, are nonattainment areas with the 8-hour ozone standard and are maintenance areas for PM_{2.5}. New London County, Connecticut, and Dukes County, Massachusetts, are in nonattainment with the 8-hour ozone standard. Baltimore County, Maryland, is in nonattainment with the 8-hour ozone standard and the SO₂ standard (EPA 2019). Table 4.3.4-5 presents the attainment status for each of the criteria pollutants for each of these locations.

CONSTRUCTION AND OPERATIONS PLAN

Site Characterization and Assessment of Impacts – Physical Resources

Table 4.3.4-5 Criteria Pollutant Attainment Status for Project Counties

State	Designation Area	Attainment Status	Criteria Pollutants						
			CO	Lead	NO ₂	Ozone	PM _{2.5}	PM ₁₀	SO ₂
NY	Albany County	Nonattainment							
		Maintenance							
		Attainment	✓	✓	✓	✓	✓	✓	✓
	Kings County	Nonattainment				✓			
		Maintenance	✓				✓		
		Attainment		✓	✓			✓	✓
	Suffolk County	Nonattainment				✓			
		Maintenance					✓		
		Attainment	✓	✓	✓			✓	✓
CT	New London County	Nonattainment				✓			
		Maintenance							
		Attainment	✓	✓	✓		✓	✓	✓
MD	Baltimore County	Nonattainment				✓			✓
		Maintenance							
		Attainment	✓	✓	✓		✓	✓	
MA	Dukes County	Nonattainment				✓			
		Maintenance							
		Attainment	✓	✓	✓		✓	✓	✓
	Bristol County	Nonattainment							
		Maintenance							
		Attainment	✓	✓	✓	✓	✓	✓	✓
NJ	Gloucester County	Nonattainment				✓			
		Maintenance					✓		
		Attainment	✓	✓	✓			✓	✓
RI	Providence County	Nonattainment							
		Maintenance							
		Attainment	✓	✓	✓	✓	✓	✓	✓
	Washington County	Nonattainment							
		Maintenance							
		Attainment	✓	✓	✓	✓	✓	✓	✓
VA	Norfolk County	Nonattainment							
		Maintenance							
		Attainment	✓	✓	✓	✓	✓	✓	✓

CONSTRUCTION AND OPERATIONS PLAN

Site Characterization and Assessment of Impacts – Physical Resources

de minimis Thresholds for General Conformity Analysis

The attainment status of areas where Project activities are expected to occur determines the applicable *de minimis* thresholds from Table 4.3.4-3 and Table 4.3.4-4. Since Washington County, Providence County, Albany County, Bristol County, and Norfolk County are attainment areas, the General Conformity Rule does not apply to the Project emissions nearest to these areas. Since Kings County is in marginal and serious nonattainment with the 2015 and 2008 8-hour ozone standard, respectively, a maintenance area for CO and PM_{2.5}, and Suffolk County is in marginal and serious nonattainment with the 2015 and 2008 8-hour ozone standard, respectively, and a maintenance area for PM_{2.5}, the emissions nearest to these areas presented in the Potential Impacts section will be compared to the *de minimis* thresholds presented in Table 4.3.4-6 below. Similarly, since New London County is in marginal and serious nonattainment with the 2015 and 2008 8-hour ozone standard, respectively, emissions nearest to this area presented in the Potential Impacts section will be compared to the *de minimis* thresholds presented in Table 4.3.4-6. Since Gloucester County is a moderate maintenance with PM_{2.5} and in moderate nonattainment with the 2015 and 2008 8-hour ozone standards, the emissions nearest to New Jersey presented in the Potential Impacts section will be compared to the *de minimis* thresholds presented in Table 4.3.4-6. Since Baltimore County is in marginal and moderate nonattainment with the 2015 and 2008 8-hour ozone standard, respectively, and out of attainment with the 2010 SO₂ standard, the emissions nearest to Maryland presented in the Potential Impacts section will be compared to the *de minimis* thresholds presented in Table 4.3.4-6. Because emissions that are expected to occur nearest to Dukes County are included in the OCS Air Permit emissions, Dukes County emissions are not applicable to General Conformity, so the *de minimis* thresholds in this area have been omitted from Table 4.3.4-6.

Table 4.3.4-6 Applicable General Conformity *de minimis* Thresholds based on Project Counties' Attainment Status

State	County	CO	Pb	NO _x	VOCs	PM _{2.5}	PM ₁₀	SO ₂
		tpy	tpy	tpy	tpy	tpy	tpy	tpy
NY	Albany County	Attainment Area – Not Applicable (N/A)						
	Suffolk County	-	-	50	50	100	100	100
	Kings County	100	-	50	50	100	100	100
RI	Washington County	Attainment Area – Not Applicable (N/A)						
	Providence County	Attainment Area – Not Applicable (N/A)						
CT	New London County	-	-	50	50	-	-	-
MA	Bristol County	Attainment Area – Not Applicable (N/A)						
NJ	Gloucester County	-	-	100	50	100	100	100
MD	Baltimore City	-	-	100	50	-	-	100
VA	Norfolk County	Attainment Area – Not Applicable (N/A)						

CONSTRUCTION AND OPERATIONS PLAN

Site Characterization and Assessment of Impacts – Physical Resources

HAPs and GHGs

Many criteria pollutant monitoring stations also measure some (but not all) HAPs, which are then reported to the EPA on a yearly basis to produce the "Monitor Values Report" (MVR). Although the MVR presents data on many different HAPs, only those that are associated with fuel oil combustion (e.g., acetaldehyde, benzene, and formaldehyde; the "fuel oil HAPs") are discussed below, since the primary sources of HAPs for the Project will be engines burning fuel oil. Ambient concentrations of fuel oil HAPs were evaluated for the entire states of New York, Connecticut, Maryland, Massachusetts, New Jersey, Rhode Island, and Virginia. The reported concentrations are indicative of overall trends. The impact of potential emissions from vessel engines in ports and along travel routes on HAP concentrations at monitoring stations will depend on a number of factors such as distance, meteorological conditions such as wind speed and direction), and the rate of deposition or degradation of the pollutant. The construction phase emissions will be temporary, and in any case, there are no air quality standards for HAPs.

In the case of GHGs, some states have set targets for reduction of GHG emissions. Regulations in 40 CFR § Part 98 require certain GHG emitters to report their GHG emissions to EPA annually. The reported GHG numbers may be used by individual states to produce an annual GHG emissions inventory. GHG data were not available for specific counties; therefore, the annual production of GHGs for each state was evaluated.

Regional Overview

In 2013, prior to issuing the commercial wind leases for the RI-MA and MA WEAs, BOEM prepared an EA of the WEAs to evaluate the reasonably foreseeable environmental impacts and socioeconomic effects of issuing renewable energy leases and subsequent site characterization activities (BOEM 2013). Included within the EA was an assessment of the existing air quality and the predominant emission sources in the WEA. BOEM's EA states that air emissions and the corresponding air quality in the RI-MA and MA WEAs is predominantly driven by vessels, as they transit to and from the many northeast commercial ports. Southerly winds in the region have the potential to transport these emissions onshore. Conversely, air quality in the SRWF is also influenced by onshore sources, as pollutants may also be carried offshore by westerly winds (BOEM 2013). In comparison to existing emission sources regularly traversing the region, an incremental increase in vessel traffic and related emissions will result from the Project construction and O&M activities. Although there are no air monitoring stations located offshore, the regional air quality discussed below effectively characterizes the offshore affected environment.

The scope of the affected environment for the assessment of potential Project-related emissions and impacts to ambient air quality encompasses offshore areas, states, and counties where Project activities may occur. These activities will result in air emissions associated with vessel traffic and equipment operation during construction and O&M activities associated with SRWF and SRWEC.

CONSTRUCTION AND OPERATIONS PLAN

Site Characterization and Assessment of Impacts – Physical Resources

As described in Section 3.3.9.4, several regional port facilities located in New York, Connecticut, Maryland, Massachusetts, New Jersey, Rhode Island, and Virginia are being considered by Sunrise Wind to support the Project. These regional port facilities include:

- Port of Albany (Albany County, NY)
- Port of Brooklyn (Kings County, NY)
- Port of Coeymans (Albany County, NY)
- Port Jefferson (Suffolk County, NY)
- Port of New York City (New York County, NY)
- Port of Montauk (Suffolk County, NY)
- Port of New London (New London County, CT)
- New Bedford Marine Commerce Terminal (Bristol County, MA)
- Sparrows Point (Baltimore County, MD)
- Paulsboro Marine Terminal (Gloucester County, NJ)
- Port of Davisville and Quonset Point (Washington County, RI)
- Port of Galilee (Washington County, RI)
- Port of Providence (Providence County, RI)
- Port of Norfolk (Norfolk, VA)

For the purposes of this discussion, existing air quality conditions for each county where port activities may occur were evaluated. Attainment status for criteria air pollutants for each county was determined to define permitting requirements. The *de minimis* emissions thresholds were identified for General Conformity requirements applicable to federal actions. Available information about HAPs and GHG emissions was also evaluated.

This page intentionally left blank

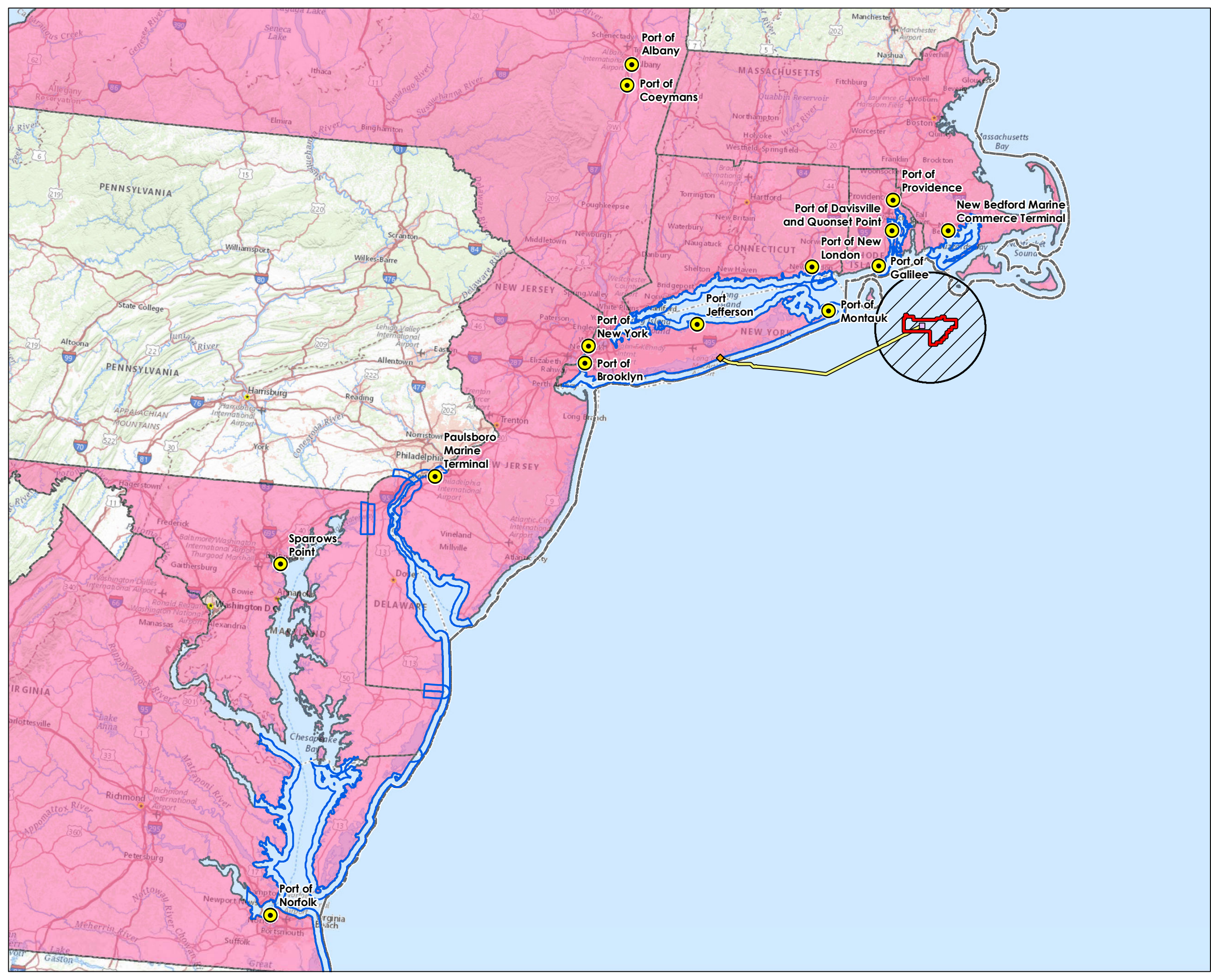

**Figure 4.3.4-1
Air Quality Study Area**

Sunrise Wind | Powered by Ørsted & Eversource

- Legend**
- Sunrise Wind Farm (SRWF)
 - Offshore Converter Station (OCS-DC)
 - ◆ SRWEC Landfall Location
 - Sunrise Wind Export Cable (SRWEC)
 - Area Subject to OCS Air Permit (25 miles from the centroid)
 - General Conformity Area
 - General Conformity Area 3-nm State Waters
 - Port Facility
 - 3-nm State Waters Boundary

Sources

1. BOEM Outer Continental Shelf Submerged Lands Act Boundary
2. Base map: The USGS National Map

Date	12/18/2020 Revised: 6/1/2021
Project Number	2028113199
Prepared By	GC
Reviewed By	LJ

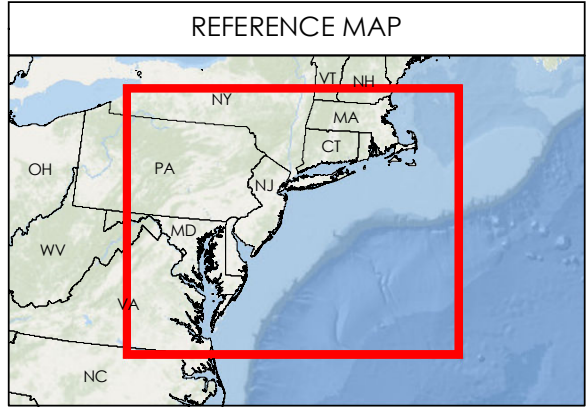
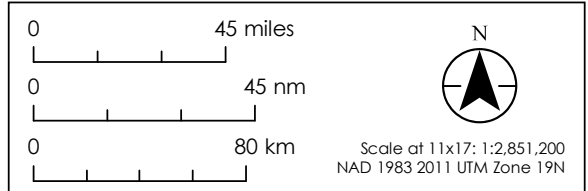

This page intentionally left blank

CONSTRUCTION AND OPERATIONS PLAN

Site Characterization and Assessment of Impacts – Physical Resources

New York

The discussion of air quality in New York applies to the New York territorial waters as well as onshore areas where the Onshore Facilities and Project-related port activity may occur. The Project may use the Port of Montauk and Port Jefferson in Suffolk County, the Port of Coeymans and Port of Albany in Albany County and a port location in Kings County, Brooklyn for construction support and O&M activities. Although air quality data are not available specifically for NYS waters, NYSDEC operates a network of 58 air monitoring stations throughout the state that measure ambient concentrations of criteria pollutants, HAPs, and ozone precursors, which are substances that react in the atmosphere to form ground-level ozone.

Per the EPA's MVR, concentrations of diesel HAPs in New York have been generally decreasing over the last ten years. Other than acetaldehyde, the ten-year concentrations of the HAPs were at their highest in 2009 and their lowest in 2014. The reported concentrations since 2014 are slightly higher but are generally steady.

Per the *2019 New York State Greenhouse Gas Inventory*, emissions of GHGs in New York in 2016 have been estimated at 205.6 million metric tons of CO₂e, which is the amount of CO₂ that would produce the same increase in global temperatures as the total of all GHGs emitted in 2016 (NYSERDA 2019). This is on target to meet the 2030 limit of 141.7 million metric tons of CO₂e in accordance with the NYS Energy Plan, which outlines initiatives to achieve their clean energy goals. These goals include a 40 percent reduction in annual GHG emissions from 1990 levels by 2030 and decreasing total carbon emissions 80 percent by 2050 (NYS 2015).

Connecticut

The discussion of air quality in Connecticut applies to the Connecticut territorial waters where Project-related port activity may occur. The Project may use one existing Connecticut port facility during construction for WTG pre-commissioning activities, the Port of New London in New London County. Although air quality data are not available specifically for Connecticut State waters, the Connecticut Department of Energy and Environmental Protection (CT DEEP) operates a network of 15 air monitoring stations throughout the state that measures ambient concentrations of criteria pollutants, HAPs, and ozone precursors.

Since diesel HAP concentrations for Connecticut were not available through the EPA's MVR, concentrations of diesel HAPs in Connecticut were determined from the EPA's Ambient Monitoring Archive (EPA 2020). The ambient concentrations of acetaldehyde, benzene, and formaldehyde between 2007 and 2015 were evaluated for Connecticut and it was found that ambient concentrations have been generally steady. The six-year concentrations of all three HAPs between 2007 and 2012 were at their highest in 2007 and their lowest in 2012, the last year that all three HAPs were reported.

Per the *2016 Connecticut Greenhouse Gas Emissions Inventory*, Connecticut GHG emissions have been estimated at 41.1 million metric tons of CO₂e in 2016 (CT DEEP 2018). This is on target to meet the 2020 limit of 40.71 million metric tons of CO₂e in accordance with the *Global Warming Solutions Act (GWSA)*, which outlines programs and policies the state could undertake to meet its commitment to reduce annual GHG emissions to at least 10 percent less than 1990 levels by 2020, and up to 45 and 80 percent less than 2001 levels by 2030 and 2050, respectively (CT DEEP 2018).

CONSTRUCTION AND OPERATIONS PLAN

Site Characterization and Assessment of Impacts – Physical Resources

Maryland

The discussion of air quality in Maryland applies to the Maryland territorial waters where Project-related port activity may occur. The Project may use one existing Maryland port facility during Project activities, Sparrow's Point in Baltimore County. Although air quality data are not available specifically for Maryland State waters, the Maryland Department of the Environment (MDE) operates a network of 24 air monitoring stations throughout the state that measures ambient concentrations of criteria pollutants, HAPs, and ozone precursors.

Per the EPA's MVR, concentrations of diesel HAPs in Maryland have been generally decreasing over the last ten years. It should be noted that acetaldehyde and formaldehyde are monitored at only one location in Maryland; therefore, the measured ambient concentrations are susceptible to local variations in air quality, rather than being an average of the entire state. Acetaldehyde peaked in 2015 and 2016, before returning to an ambient concentration less than 1.0 µg/m³. Benzene peaked in 2012 before also returning to an ambient concentration less than 1.0 µg/m³. Prior to 2018, ambient formaldehyde concentrations had peaked in 2010; however, measured concentrations in 2018 were slightly higher than those measured in 2010.

Per Maryland's *2017 Periodic GHG Emissions Inventory*, emissions of GHGs in Maryland have been estimated at 78.5 million metric tons of CO₂e in 2017 (MDE 2019). This is below the 2020 limit of 80.4 million metric tons of CO₂e, in accordance with the state's *Greenhouse Gas Emissions Reduction Act Plan*, which outlines programs and policies the state could undertake to meet its commitment to reduce annual GHG emissions to at least 25 percent less than 2006 levels by 2020 (MDE 2019).

Massachusetts

The discussion of air quality in Massachusetts applies to the Massachusetts territorial waters where Project-related port activity may occur. The Project may use one existing Massachusetts port facility during construction for WTG pre-commissioning activities, the New Bedford Marine Commerce Terminal in Bristol County. In addition, as the NOAA, the Project emissions have the potential to impact Dukes County, Massachusetts. Although air quality data are not available specifically for Massachusetts State waters, the Massachusetts Department of Environmental Protection (MassDEP) operates a network of 22 air monitoring stations throughout the state that measures ambient concentrations of criteria pollutants, HAPs, and ozone precursors. In addition, MassDEP receives data from the Wampanoag Tribe of Gay Head (Aquinnah), which operates an air monitoring station on Martha's Vineyard, in Dukes County, Massachusetts.

Per EPA's MVR, concentrations of diesel HAPs in Massachusetts have been generally steady over the last ten years. The ten-year concentrations of all three HAPs peaked in 2013 to 2015 and have since returned to similar concentrations as 2009.

Per the *Statewide Greenhouse Gas Emissions Level Report*, GHG emissions have been estimated at 73.3 million metric tons of CO₂e in 2017 (MassDEP 2017). This is on target to meet the 2020 limit of 70.8 million metric tons of CO₂e in accordance with the GWSA, which outlines programs and policies the state could undertake to meet its commitment to reduce annual GHG emissions to at least 25 percent less than 1990 levels by 2020, and up to 80 percent less than 1990 levels by 2050 (MassDEP 2017).

CONSTRUCTION AND OPERATIONS PLAN

Site Characterization and Assessment of Impacts – Physical Resources

New Jersey

The discussion of air quality in New Jersey applies to the New Jersey territorial waters where Project-related port activity may occur. The Project may use one existing New Jersey port facility during construction for foundation fabrication activities, the Paulsboro Marine Terminal in Gloucester County. Although air quality data are not available specifically for New Jersey State waters, the New Jersey Department of Environmental Protection (NJDEP) operates a network of 32 air monitoring stations throughout the state that measures ambient concentrations of criteria pollutants, HAPs, and ozone precursors.

Per the EPA's MVR, concentrations of diesel HAPs in New Jersey have been generally steady over the last ten years. The ten-year concentrations of all three HAPs were at their highest in 2014 and their lowest in 2018.

Per the *2015 Statewide Greenhouse Gas Emissions Inventory*, emissions of GHG in New Jersey have been estimated at 100.9 million metric tons of CO₂e in 2015 (NJDEP 2017). This is less than the 2020 target of 125.6 million metric tons of CO₂e, in accordance with the *2007 Global Warming Reduction Act*, which outlines programs and policies the state could undertake to meet its commitment to reduce annual GHG emissions to at least 1990 levels by 2020, and up to 80 percent less than 2006 levels by 2050 (NJDEP 2017).

Rhode Island

The discussion of air quality in Rhode Island applies to the Rhode Island territorial waters where Project-related port activity may occur. The Port of Davisville and Port of Galilee are being considered for construction and O&M support activities, while the Port of Providence is being considered to support WTG and OCS–DC foundations activities. Although air quality data are not available specifically for Rhode Island State waters, the RIDEM, in conjunction with the Rhode Island Department of Health, operates a network of eight air monitoring stations throughout the state that measures ambient concentrations of criteria pollutants, HAPs, and ozone precursors.

Per the EPA's MVR, concentrations of diesel HAPs in Rhode Island have been generally decreasing over the last ten years. The ten-year concentrations of acetaldehyde, benzene, and formaldehyde were generally at their highest in 2009 and their lowest in 2013 to 2014. The reported concentrations since 2014 have been slightly higher but are generally steady.

Per the *2016 Rhode Island Greenhouse Gas Emissions Reduction Plan*, emissions of GHGs in Rhode Island have been estimated at 11.3 million metric tons of CO₂e in 2015 (Executive Climate Change Coordinating Council [EC4] 2016). This is on target to meet the 2020 limit of 11.23 million metric tons of CO₂e in accordance with the 2014 Resilient Rhode Island Act, which outlines programs and policies the state could undertake to meet its commitment to reduce annual GHG emissions to at least 10 percent less than 1990 levels by 2020, and up to 80 percent less than 1990 levels by 2050 (EC4 2016).

CONSTRUCTION AND OPERATIONS PLAN

Site Characterization and Assessment of Impacts – Physical Resources

Virginia

The discussion of air quality in Virginia applies to the Virginia territorial waters where Project-related port activity may occur. The Project may also use the Port of Norfolk in Norfolk for WTG pre-commissioning activities. Although air quality data are not available specifically for Virginia State waters, the Virginia Department of Environmental Quality operates a network of 38 air monitoring stations throughout the state that measures ambient concentrations of criteria pollutants, HAPs, and ozone precursors.

Per the EPA's MVR, concentrations of diesel HAPs in Virginia have been generally decreasing over the last ten years. With the exception of benzene, the ten-year concentrations of the HAPs were at their highest in 2010 and their lowest in 2015 to 2016. The reported concentrations since 2016 have been slightly higher but are generally steady.

Virginia has not performed a GHG emissions inventory; therefore, GHG emissions specific to Virginia are not discussed.

Project Area

Emissions that occur within a 25-mi radius from OCS sources at the SRWF and the SRWEC–OCS will be subject to the 40 CFR Part 55 regulations. The General Conformity requirements will apply to emissions that occur outside the OCS area but within state jurisdictional boundaries (e.g., along the SRWEC–NYS and for the Onshore facilities), including stationary sources onshore and emissions from vessels transiting to and from the OCS sources. These emissions are apportioned to the state nearest to where the emissions will occur based on the assumptions for Project vessel trips between the SRWF, SRWEC, and ports, as well as the SRWEC Landfall location. NEPA emissions include emissions that occur outside of the OCS Permit Area, and beyond 3 nm (3.4 mi; 5.6 km) of any onshore area, and therefore, are not subject to any other permitting or General Conformity programs. Emissions that could occur beyond 200 nm (230 mi; 370 km) from shore (outside of federal waters) during travel to and from foreign ports are not considered within the OCS Permit, General Conformity, or NEPA review process and so are not provided herein.

Sunrise Wind Farm

This area includes potential emissions related to the construction and O&M of OCS sources at the SRWF, which include the OCS–DC and WTGs, to the extent they have a potential to emit. It also includes emissions from vessels meeting the definition of OCS source (40 CFR § 55.2), and vessels traveling to and from the Project when within 25 mi (21.7 nm; 40.2 km) of the OCS source(s). OCS permitting requirements under 40 CFR Part 55 will apply.

Sunrise Wind Export Cable–OCS

This area includes potential emissions related to the construction and O&M of the SRWEC–OCS, including construction vessels and equipment attached to the seafloor, erected thereon, and conducting cable laying. Construction and O&M vessels within 25 mi of the OCS source supporting the SRWEC–OCS source(s) will also be included. OCS permitting requirements under 40 CFR Part 55 will apply.

CONSTRUCTION AND OPERATIONS PLAN

Site Characterization and Assessment of Impacts – Physical Resources

Sunrise Wind Export Cable–NYS and New York State

This area includes: (1) potential emissions related to the construction of the portion of the export cable that is within NYS waters (SRWEC–NYS); (2) potential emissions related to SRWF and SRWEC construction equipment and construction and O&M vessels transiting through NYS waters; and (3) potential emissions at NYS Onshore Facilities (e.g., the Onshore Transmission Cable, OnCS–DC, Onshore Interconnection Cable, and fiber optic cable). These emissions will be considered under the General Conformity Rule in 40 CFR Part 93.

Other States

This area includes potential emissions related to the construction of the SRWF and SRWEC outside the OCS area but within waters of states other than NY (e.g., SRWF and SRWEC construction vessels transiting through waters of other states, and at ports in other states). These emissions will be apportioned between the affected states and considered under the General Conformity Rule in 40 CFR Part 93.

4.3.4.2 Potential Impacts

Construction, O&M, and decommissioning activities associated with the SRWF, OCS–DC, SRWEC–OCS, SRWEC–NYS, and Onshore Facilities have the potential to adversely impact the existing air quality conditions discussed above in Section 4.3.4.1. Air emissions are the only IPF identified with respect to impacts to air quality (Figure 4.3.4-2). The primary causes of impacts from the Project are air emissions from marine vessels, on-vessel equipment, onshore, road and non-road vehicles, and equipment powered by stationary engines (e.g., generators). For the decommissioning phase of the Project, impacts are anticipated to be similar to or less adverse than those described for construction; therefore, impacts from decommissioning are not addressed separately in this section. Decommissioning will occur 25 to 35 years in the future and will be done in accordance with requirements in effect at that time. More detailed information regarding potential impacts on air quality can be found in the emissions inventory in Appendix K. Potential air quality impacts associated with the Project will be greatest during construction and significantly less during the O&M phase (see Table 4.3.4-7 through Table 4.3.4-10 below). Emissions during Project construction will be temporary and will cease following the completion of construction. Although there will be air emissions associated with the Project construction and O&M, these emissions will be far less than the avoided air emissions, both annually and over the expected life of the Project (see Table 4.3.4-11 below).

Sunrise Wind Farm

Air emissions will occur as a result of the installation of the WTGs and OCS–DC and other activities associated with construction and O&M phases of the Project. Emissions have been estimated separately for these phases. The primary causes of potential air quality impacts include emissions from the fleet of marine vessels, on-vessel equipment, and generators located on the OCS–DC.

CONSTRUCTION AND OPERATIONS PLAN

Site Characterization and Assessment of Impacts – Physical Resources

Construction

Offshore vessels and on-vessel equipment powered by engines will be the primary sources of air emissions during construction of the SRWF. These vessels will be used for transporting and installing the foundations, WTGs, OCS-DC, and cables, as well as transporting crew personnel to and from the SRWF. Diesel generators located on vessels, WTGs, and the OCS-DC will be used during the construction and commissioning of the turbines. These emissions are expected to occur during the approximate one-year to 18-month offshore construction phase, though use of mobile diesel generators during the commissioning of the WTGs is expected to last less than a year. In the event that the SRWEC is energized prior to commissioning of the WTGs, the use of diesel generators would be reduced. Construction-related emissions from vessels and portable diesel generators on the WTGs will be temporary and will cease when construction is completed. Fugitive emissions of SF₆ may occur from the gas-insulated switchgear in each of the WTGs during construction of the SRWF. For the purposes of this analysis, it is conservatively assumed that SF₆ emissions during the first year will occur in the construction phase, and in the O&M phase in subsequent years. It is also assumed that leakage could occur at a rate of 1 percent annually resulting in a total of up to 0.009 tons of SF₆ from all WTGs during the first year of construction. Unlike the other construction-related emissions, fugitive SF₆ would occur annually during the O&M phase. However, the gas-insulated switchgears will be manufactured to be completely sealed and would likely result in little or no SF₆ emissions. Estimated potential emissions of SF₆ are presented in Appendix K.

Emission sources associated with construction of the SRWF are listed in the emissions inventory in Appendix K. Estimated emissions from these sources during the construction phase are shown in Table A1 in Appendix K.

CONSTRUCTION AND OPERATIONS PLAN

Site Characterization and Assessment of Impacts – Physical Resources

Table 4.3.4-7 Estimated OCS Permit Emissions during Construction of the Sunrise Wind Project

Project Component	CO ₂	CH ₄	N ₂ O	CO ₂ e	Black Carbon	CO	NO _x	PM ₁₀	PM _{2.5}	SO ₂	Lead	VOC
	(tons/year)											
Emissions within 25 miles of SRWF/SRWECC centroid (OCS Permit)												
Total Emissions	227,230	1.4	10.9	230,504	29.7	869.4	2,092.8	38.6	38.6	2.1	0.006	49.1
SRWF	112,025	0.7	5.4	113,639	14.6	428.6	1,031.8	19.0	19.0	1.0	0.003	24.2
Foundation Installation	69,676	0.4	3.3	70,680	9.1	266.6	641.7	11.8	11.8	0.6	0.002	15.0
Offshore Converter Station Installation	10,495	0.1	0.5	10,646	1.4	40.2	96.7	1.8	1.8	0.1	0.000	2.3
Turbine Installation	4,958	0.0	0.2	5,030	0.6	19.0	45.7	0.8	0.8	0.0	0.000	1.1
Offshore Array Cable Installation	26,510	0.2	1.3	26,892	3.5	101.4	244.2	4.5	4.5	0.2	0.001	5.7
Offshore Generators	386	0.0	0.0	392	0.1	1.5	3.6	0.1	0.1	0.0	0.000	0.1
SRWECC	42,507	0.3	2.0	43,120	5.6	162.6	391.5	7.2	7.2	0.4	0.001	9.2
Offshore Export Cable Installation	42,507	0.3	2.0	43,120	5.6	162.6	391.5	7.2	7.2	0.4	0.001	9.2
Crew Transport and Support (All Construction Activities)	72,698	0.4	3.5	73,745	9.5	278.1	669.6	12.3	12.3	0.7	0.002	15.7

CONSTRUCTION AND OPERATIONS PLAN

Site Characterization and Assessment of Impacts – Physical Resources

Table 4.3.4-8 Estimated Emissions in Federal Waters Outside the OCS Area during Construction of the Sunrise Wind Project

Project Component	CO ₂	CH ₄	N ₂ O	CO _{2e}	Black Carbon	CO	NO _x	PM ₁₀	PM _{2.5}	SO ₂	Lead	VOC
	(tons/year)											
Emissions in Federal waters outside 25 miles of SRWF/SRWECE centroid												
Supported from Port of Coeymans/Port of Albany	42,242	0.3	2.0	42,850	5.5	161.6	389.1	7.2	7.2	0.4	0.001	9.1
SRWF	42,242	0.3	2.0	42,850	5.5	161.6	389.1	7.2	7.2	0.4	0.001	9.1
Support from NYC Port	32,742	0.2	1.6	33,213	4.3	125.3	301.6	5.6	5.6	0.3	0.001	7.1
SRWF	16,331	0.1	0.8	16,566	2.1	62.5	150.4	2.8	2.8	0.2	0.000	3.5
SRWECE	16,410	0.1	0.8	16,647	2.1	62.8	151.1	2.8	2.8	0.2	0.000	3.5
Supported from Port of New London	3,562	0.0	0.2	3,614	0.5	13.6	32.8	0.6	0.6	0.0	0.000	0.8
SRWF	3,562	0.0	0.2	3,614	0.5	13.6	32.8	0.6	0.6	0.0	0.000	0.8
Supported from Port of Providence	27,550	0.2	1.3	27,947	3.6	105.4	253.7	4.7	4.7	0.3	0.001	6.0
SRWF	23,430	0.1	1.1	23,768	3.1	89.6	215.8	4.0	4.0	0.2	0.001	5.1
SRWECE	4,120	0.0	0.2	4,179	0.5	15.8	37.9	0.7	0.7	0.0	0.000	0.9
Supported from Port of New Bedford	1,016	0.0	0.0	1,031	0.1	3.9	9.4	0.2	0.2	0.0	0.000	0.2
SRWF	1,016	0.0	0.0	1,031	0.1	3.9	9.4	0.2	0.2	0.0	0.000	0.2
Supported from Quonset/Port of Davisville	34,902	0.2	1.7	35,405	4.6	133.5	321.5	5.9	5.9	0.3	0.001	7.5
Crew Transport and Support (All Construction Activities)	34,902	0.2	1.7	35,405	4.6	133.5	321.5	5.9	5.9	0.3	0.001	7.5
Supported from Port of Paulsboro	67,069	0.4	3.2	68,036	8.8	256.6	617.7	11.4	11.4	0.6	0.002	14.5
SRWF	67,069	0.4	3.2	68,036	8.8	256.6	617.7	11.4	11.4	0.6	0.002	14.5
Supported from Sparrows Point	76,760	0.5	3.7	77,866	10.0	293.7	707.0	13.0	13.0	0.7	0.002	16.6
SRWF	76,760	0.5	3.7	77,866	10.0	293.7	707.0	13.0	13.0	0.7	0.002	16.6
Supported from Port of Norfolk	74,539	0.5	3.6	75,613	9.7	285.2	686.5	12.6	12.6	0.7	0.002	16.1
SRWF	74,539	0.5	3.6	75,613	9.7	285.2	686.5	12.6	12.6	0.7	0.002	16.1

CONSTRUCTION AND OPERATIONS PLAN

Site Characterization and Assessment of Impacts – Physical Resources

Table 4.3.4-9 Estimated General Conformity Emissions during Construction of the Sunrise Wind Project

Project Component	CO ₂	CH ₄	N ₂ O	CO ₂ e	Black Carbon	CO	NO _x	PM ₁₀	PM _{2.5}	SO ₂	Lead	VOC
	(tons/year)											
Emissions General Conformity												
Emissions within 3 miles of NY	32,383	0.7	1.7	32,893	4.3	123.9	348.2	5.7	6.6	1.2	0.001	7.8
SRWF	3,820	0.0	0.2	3,875	0.5	14.6	35.2	0.6	0.6	0.0	0.000	0.8
Onshore Emissions	8	0.0	0.0	52	0.0	0.0	50	0.0	1.0	1.0	-	1.0
Supported from Port of Coeymans/Port of Albany	22,743	0.1	1.1	23,071	3.0	87.0	209.5	3.9	3.9	0.2	0.001	4.9
SRWF	22,743	0.1	1.1	23,071	3.0	87.0	209.5	3.9	3.9	0.2	0.001	4.9
Support from NYC Port	5,811	0.0	0.3	5,895	0.8	22.2	53.5	1.0	1.0	0.1	0.000	1.3
SRWF	3,017	0.0	0.1	3,061	0.4	11.5	27.8	0.5	0.5	0.0	0.000	0.7
SRWEC	2,794	0.0	0.1	2,834	0.4	10.7	25.7	0.5	0.5	0.0	0.000	0.6
Emissions within 3 miles of RI	53,852	0.6	2.6	54,654	7.1	206.0	496.0	9.2	9.1	0.5	0.001	11.6
Supported from Port of Providence	23,501	0.1	1.1	3,840	3.1	89.9	216.4	4.0	4.0	0.2	0.001	5.1
SRWF	18,413	0.1	0.9	18,678	2.4	70.4	169.6	3.1	3.1	0.2	0.000	4.0
SRWEC	5,088	0.0	0.2	5,162	0.7	19.5	46.9	0.9	0.9	0.0	0.000	1.1
Supported from Quonset/Port of Davisville	30,351	0.5	1.5	30,815	4.0	116.1	279.5	5.2	5.2	0.3	0.001	6.6
Crew Transport and Support (All Construction Activities)	30,349	0.2	1.5	30,787	4.0	116.1	279.5	5.2	5.2	0.3	0.001	6.6
Onshore Emissions	2	0.3	0.1	28	0.0	0.0	-	0.0	-	-	-	-
Emissions within 3 miles of CT	1,058	0.0	0.1	1,074	0.1	4.0	9.7	0.2	0.2	0.0	0.000	0.2
Supported from Port of New London	1,058	0.0	0.1	1,074	0.1	4.0	9.7	0.2	0.2	0.0	0.000	0.2
SRWF	1,058	0.0	0.1	1,074	0.1	4.0	9.7	0.2	0.2	0.0	0.000	0.2
Emissions within 3 miles of MA	1,006	0.0	0.0	1,020	0.1	3.8	9.3	0.2	0.2	0.0	0.000	0.2
Supported from Port of New Bedford	1,006	0.0	0.0	1,020	0.1	3.8	9.3	0.2	0.2	0.0	0.000	0.2
SRWF	1,006	0.0	0.0	1,020	0.1	3.8	9.3	0.2	0.2	0.0	0.000	0.2

CONSTRUCTION AND OPERATIONS PLAN

Site Characterization and Assessment of Impacts – Physical Resources

Project Component	CO ₂	CH ₄	N ₂ O	CO ₂ e	Black Carbon	CO	NO _x	PM ₁₀	PM _{2.5}	SO ₂	Lead	VOC
	(tons/year)											
Emissions within 3 miles of NJ	6,693	0.0	0.3	6,789	0.9	25.6	61.6	1.1	1.1	0.1	0.000	1.4
Supported from Port of Paulsboro	6,693	0.0	0.3	6,789	0.9	25.6	61.6	1.1	1.1	0.1	0.000	1.4
SRWF	6,693	0.0	0.3	6,789	0.9	25.6	61.6	1.1	1.1	0.1	0.000	1.4
Emissions within 3 miles of MD	72,162	0.4	3.5	73,202	9.4	276.1	664.6	12.2	12.2	0.7	0.002	15.6
Supported from Sparrows Point	72,162	0.4	3.5	73,202	9.4	276.1	664.6	12.2	12.2	0.7	0.002	15.6
SRWF	72,162	0.4	3.5	73,202	9.4	276.1	664.6	12.2	12.2	0.7	0.002	15.6
Emissions within 3 miles of VA	1,122	0.0	0.1	1,138	0.1	4.3	10.3	0.2	0.2	0.0	0.000	0.2
SRWF	753	0.0	0.0	764	0.1	2.9	6.9	0.1	0.1	0.0	0.000	0.2
Supported from Port of Norfolk	369	0.0	0.0	374	0.0	1.4	3.4	0.1	0.1	0.0	0.000	0.1
SRWF	369	0.0	0.0	374	0.0	1.4	3.4	0.1	0.1	0.0	0.000	0.1

CONSTRUCTION AND OPERATIONS PLAN

Site Characterization and Assessment of Impacts – Physical Resources

Table 4.3.4-10 Estimated Emissions during Operations and Maintenance of the Sunrise Wind Project

Project Component	CO ₂	CH ₄	N ₂ O	CO ₂ e	Black Carbon	CO	NO _x	PM ₁₀	PM _{2.5}	SO ₂	Lead	VOC
	(tons/year)											
Emissions within 25 miles of SRWF/SRWEC centroid												
Total Emissions	19,955	0.1	1.0	20,242	2.6	76.3	183.8	3.4	3.4	0.2	0.001	4.3
Crew Transport and Support	19,763	0.1	0.9	20,048	2.6	75.6	182.0	3.4	3.4	0.2	0.001	4.3
Offshore Converter Station Emergency Generator(s)	192	0.0	0.0	195	0.0	0.7	1.8	0.0	0.0	0.0	0.000	0.0
Emissions General Conformity												
Emissions within 3 miles of NY	5,903	0	0	6,001	1	23	54	1	1	0	0	1
Supported from Port Jefferson	4,670	0	0	4,751	1	18	43	1	1	0	0	1
Crew Transport and Support	4,668	0.0	0.2	4,736	0.6	17.9	43.0	0.8	0.8	0.0	0.000	1.0
Onshore Emissions	2	0.1	0.0	15	0.0	0.0	-	0.0	-	-	-	-
Supported from Port of Brooklyn	5,903	0	0	6,001	1	23	54	1	1	0	0	1
Crew Transport and Support	5,901	0.0	0.3	5,986	0.8	22.6	54.4	1.0	1.0	0.1	0.000	1.3
Onshore Emissions	2	0.1	0.0	15	0.0	0.0	-	0.0	-	-	-	-
Emissions within 3 miles of RI	3,393	0	0	3,461	0	13	31	1	1	0	0	1
Supported from Quonset/Port of Davisville	3,393	0	0	3,461	0	13	31	1	1	0	0	1
Crew Transport and Support	3,392	0.0	0.2	3,440	0.4	13.0	31.2	0.6	0.6	0.0	0.000	0.7
Onshore Emissions	2	0.2	0.0	20	0.0	0.0	-	0.0	-	-	-	-
Supported from Port of Galilee	1,895	0	0	1,941	0	7	17	0	0	0	0	0
Crew Transport and Support	1,894	0.0	0.1	1,921	0.2	7.2	17.4	0.3	0.3	0.0	0.000	0.4
Onshore Emissions	2	0.2	0.0	20	0.0	0.0	-	0.0	-	-	-	-

CONSTRUCTION AND OPERATIONS PLAN

Site Characterization and Assessment of Impacts – Physical Resources

Project Component	CO ₂	CH ₄	N ₂ O	CO ₂ e	Black Carbon	CO	NO _x	PM ₁₀	PM _{2.5}	SO ₂	Lead	VOC
	(tons/year)											
Emissions in Federal waters outside 25 miles of SRWF/SRWEC centroid												
Supported from Port Jefferson – Crew Transport and Support	856	0.0	0.0	869	0.1	3.3	7.9	0.1	0.1	0.0	0.000	0.2
Supported from Port of Brooklyn – Crew Transport and Support	34,894	0.2	1.7	35,397	4.6	133.5	321.4	5.9	5.9	0.3	0.001	7.5
Supported from Quonset/Port of Davisville – Crew Transport and Support	7,045	0.0	0.3	7,146	0.9	27.0	64.9	1.2	1.2	0.1	0.000	1.5
Supported from Port of Galilee – Crew Transport and Support	2,406	0.0	0.1	2,441	0.3	9.2	22.2	0.4	0.4	0.0	0.000	0.5

CONSTRUCTION AND OPERATIONS PLAN

Site Characterization and Assessment of Impacts – Physical Resources

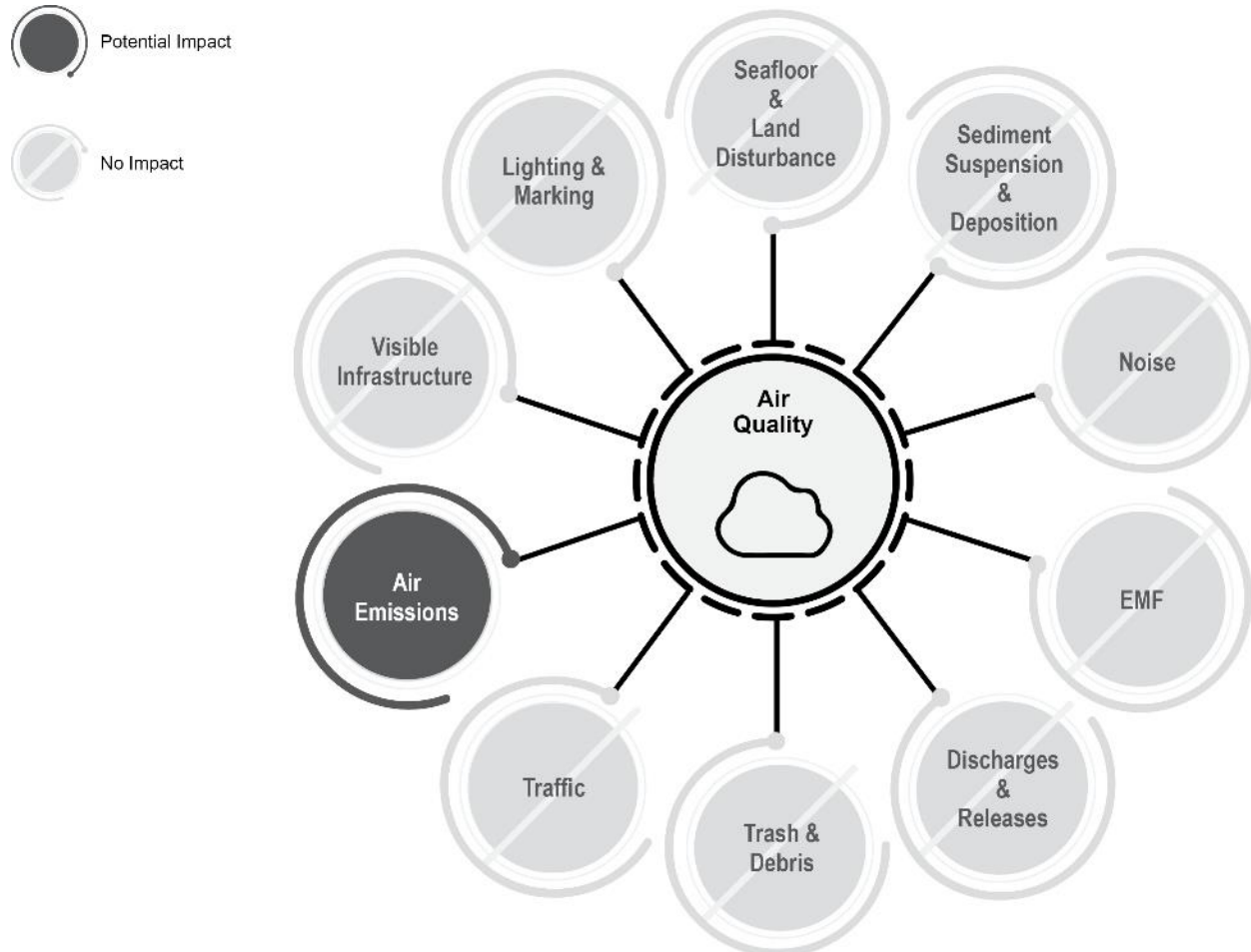

Figure 4.3.4-2 Impact Producing Factors on Air Quality

Operations and Maintenance

During the O&M phase, there will be emissions from vessels traveling to and from the SRWF for maintenance of the WTGs and OCS–DC, and from on-vessel equipment used for maintenance. Because of the significantly smaller vessel fleet required during O&M, these emissions will be much less than the construction-phase emissions. The operation of the WTGs will not itself emit any criteria pollutants, as temporary diesel generators used during construction will be removed after commissioning of the WTGs. Fugitive emissions of SF₆ may occur at a rate of 1 percent annually from the gas-insulated switchgear in each of the WTGs resulting in a total of up to 0.009 tons of SF₆ from all WTGs per year. Medium- and high-voltage gas-insulated switchgears associated with the OCS–DC could also contribute up to 0.020 tons of SF₆ each year. However, gas-insulated switchgears are manufactured to be completely sealed and would likely result in little or no SF₆ emissions. Estimated potential emissions of SF₆ are presented in Appendix K.

Emission sources associated with the O&M phase of the SRWF are listed in the emissions inventory in Appendix K. Estimated emissions from this phase are shown in Table A4 in Appendix K.

CONSTRUCTION AND OPERATIONS PLAN

Site Characterization and Assessment of Impacts – Physical Resources

Sunrise Wind Export Cable–OCS

Construction

Offshore vessels and on-vessel equipment powered by engines will be the primary sources of air emissions during construction of the SRWEC–OCS. These vessels and equipment will be used for transporting and installing the SRWEC–OCS. Crew transport vessels will be used to transport crew personnel to and from the site. Emissions associated with the installation of the SRWEC–OCS are expected to occur during the approximate 8-month construction phase. Construction-related emissions will be temporary and will cease when construction is completed.

Emission sources associated with the construction phase of the SRWEC–OCS are listed in the emissions inventory in Appendix K. Estimated emissions from this phase are shown in Table A1 in Appendix K. Additionally, estimated emissions in Federal waters outside of the OCS area during construction of this phase are shown in Table A2.

Operations and Maintenance

During the O&M phase, there will be emissions from vessels traveling to and from areas of the OCS along the cable corridor for maintenance of the SRWEC–OCS as needed. On-vessel equipment used during maintenance activities will also produce emissions during the O&M phase; however, these emissions will be much less than construction-phase emissions for the SRWEC–OCS. The SRWEC–OCS itself would not emit.

Emission sources associated with the O&M phase of the SRWEC–OCS are listed in the emissions inventory in Appendix K. Estimated emissions from this phase are shown in Table A4 in Appendix K.

Sunrise Wind Export Cable–NYS

Construction

There will be air emissions from marine vessels, on-vessel equipment, and onshore equipment used for the construction of the portion of the SRWEC–NYS; offshore vessels transiting through state waters during the construction phase; and the construction of Onshore Facilities. Construction-related emissions from vessels and portable diesel generators will be temporary and will cease when construction is completed.

Emission sources associated with the construction phase of the SRWEC–NYS are listed in the emissions inventory in Appendix K. Estimated emissions from this phase are shown in Table A1 in Appendix K. Estimated General Conformity emissions are summarized in Table A3.

Operations and Maintenance

There will be air emissions from offshore vessels, on-vessel equipment, and onshore equipment used for the O&M of the portion of the export cable that is within state waters; offshore vessels transiting through state waters during the O&M phase; and the maintenance of Onshore Facilities. Because of the significantly smaller vessel fleet required during O&M, these emissions will be much less than the construction-phase emissions.

Emission sources associated with the O&M phase of the SRWEC–NYS are listed in the emissions inventory in Appendix K. Estimated emissions from this phase are shown in Table A4 in Appendix K.

CONSTRUCTION AND OPERATIONS PLAN

Site Characterization and Assessment of Impacts – Physical Resources

Onshore Facilities

Construction

During construction of the Onshore Transmission Cable, OnCS–DC, and Onshore Interconnection Cable, there will be a variety of road and non-road engines in use that will produce emissions. Construction-related emissions associated with these engines during construction of the Onshore Facilities will be temporary and will cease when construction is completed.

Emission sources associated with the construction phase of the Onshore Transmission Cable, OnCS–DC, and Onshore Interconnection Cable are listed in the emissions inventory in Appendix K. Estimated emissions from this phase are shown in Table A1 in Appendix K.

In addition to air emissions, a localized increase in fugitive dust may result during onshore construction activities. To minimize potential emissions of fugitive dust during construction, the Project would develop a dust control plan including a robust dust control program that would be required as part of contract specifications. Further information on dust control measures will be detailed in the SWPPP prepared as part of the Project EM&CP. Operations and Maintenance

During the O&M phase, fugitive emissions of SF₆ may occur at a rate of 1 percent annually from the gas-insulated switchgear bay associated with the OnCS–DC resulting in up to 0.018 tons of SF₆ each year. However, gas-insulated switchgears are manufactured to be completely sealed and would likely result in little or no SF₆ emissions. Additionally, OnCS–DC devices containing SF₆ will be equipped with integral low-pressure detectors to detect SF₆ gas leakages should they occur. Emission sources associated with the O&M phase from the Onshore Transmission Cable, OnCS–DC, and Onshore Interconnection Cable are listed in the emissions inventory in Appendix K. Estimated emissions from this phase are shown in Table A4 in Appendix K.

Other States

Construction

There may be air emissions from offshore vessels and on-vessel equipment during vessel transit to and from port facilities through state waters of Connecticut, Massachusetts, New Jersey, and Rhode Island during the construction phase. These emissions would be temporary and would cease following the completion of construction activities and commissioning of the Project.

Estimated emissions from the construction phase are shown in Table A1 in Appendix K.

Operations and Maintenance

There may be air emissions from offshore vessels transiting through state waters of New York, Connecticut, and Rhode Island during the O&M phase. Because of the significantly smaller vessel fleet required during O&M, these emissions will be much less than the construction-phase emissions.

Estimated emissions from the operation and maintenance phase are shown in Table A4 in Appendix K. Details of the emission estimates from this phase are included in the emissions inventory presented in Appendix K.

CONSTRUCTION AND OPERATIONS PLAN

Site Characterization and Assessment of Impacts – Physical Resources

4.3.4.3 Proposed Environmental Protection Measures

It is important to acknowledge that the use of wind to generate electricity reduces the need for electricity generation from traditional fossil fuel-powered plants that produce GHG emissions. Table 4.3.4-11 presents the estimated annual avoided emissions from the operation of the SRWF. Avoided emissions were based on avoided emission factors (BOEM 2017), a maximum 3,854,400 MW-hours generated per year, and a minimum 3,083,520 MW-hours generated per year. The table also shows the estimated emissions over a period of 25 years.

The Project is expected to displace annual emissions of CO₂, CH₄, N₂O, NO_x, SO₂, and other pollutants produced by suppliers to the electric grid and decrease the contribution of GHG from these sources.

Sunrise Wind will implement the following environmental protection measures to reduce potential impacts on air quality. These measures are based on protocols and procedures successfully implemented for similar projects.

- Diesel generators on WTGs and the OCS–DC will only burn low sulfur diesel in the engines. Diesel generators on WTGs will only be used temporarily during commissioning or in an emergency power outage.
- Vessels meeting the definition of an OCS source and providing construction or maintenance services for the SRWF and SRWEC will use low sulfur fuel, Marine Distillate, or Marine Residual fuels when operating any diesel-fired emission unit, as specified by applicable regulations or OCS Permit conditions.
- Vessel engines will meet the applicable United States Environmental Protection Agency (EPA) air emission standards, as specified in the OCS Permit, to satisfy Best Available Control Technology (BACT) or Lowest Achievable Emission Rate (LAER).
- Onshore Facilities equipment and fuel suppliers will provide equipment and fuels that comply with the applicable EPA or equivalent emission standards.
- Potential fugitive emissions of particulate matter from onshore construction activities will be minimized by implementing dust control measures.
- Gas-insulated switchgears are manufactured to be completely sealed and would likely result in little or no SF₆ emissions. Switchgears containing SF₆ on the WTG, OCS–DC, and OnCS–DC will be equipped with integral low-pressure detectors to detect SF₆ gas leakages should they occur.
- Sunrise Wind will obtain emission reduction credits to offset emissions from construction and O&M activities, if required as a condition of the OCS Permit.

CONSTRUCTION AND OPERATIONS PLAN

Site Characterization and Assessment of Impacts – Physical Resources

Table 4.3.4-11 Emissions Avoided by Construction of the Project (tons) for Various Pollutants

Avoided Emissions	Power Generated (MW hours)	CO ₂	CH ₄	N ₂ O	CO ₂ e	NO _x	VOC	SO ₂	CO	PM ₁₀	PM _{2.5}	Black carbon	Lead
Maximum Annual	3,854,400	2,592,802	85	11	2,598,205	1,474	106	1,534	1,725	337	471	16	0.04
Minimum Annual	3,083,520	2,074,241	68	9	2,078,623	1,179	85	1,227	1,380	270	377	13	0.03
Maximum over 25 years	96,360,000	64,820,041	2,112	275	64,954,791	36,857	2,655	38,351	43,124	8,432	11,783	396	1.06
Minimum over 25 years	77,088,000	51,856,033	1,689	220	51,963,818	29,486	2,124	30,681	34,499	6,745	9,426	317	0.85

CONSTRUCTION AND OPERATIONS PLAN

Site Characterization and Assessment of Impacts – Biological Resources

4.4 Biological Resources

4.4.1 Coastal and Terrestrial Habitat

This section describes the affected environment and potential effects from the construction and operation of the Project as they relate to coastal and terrestrial habitat. The description of the affected environment and assessment of potential impacts were developed by reviewing publicly available online data portals and GIS mapping databases (e.g., the Federal Emergency Management Agency [FEMA] Flood Maps, NOAA Marine Protected Areas, USFWS National Wetlands Inventory (NWI), United States Geological Survey Protected Lands of the United States, NYSDEC Significant Coastal Fish and Wildlife Habitat (SCFWH) and NYSDEC Bird Conservation Areas, Critical Environmental Areas, Tidal Wetlands, NYNHP Significant Natural Communities, NY IMap Invasives iMAP3, State-Regulated Freshwater Wetlands and Listed Plant and Animal Species), and through communications with federal, state, and local agencies.

Specific requirements for submittal of coastal and terrestrial habitat information within this COP are provided in BOEM's Guidelines for 30 CFR § 585.62 pursuant to 30 CFR Part 585 Subpart F. In addition, field surveys of the Onshore Facilities were conducted in June and October 2020 and March 2021 to delineate wetlands and waterbodies, classify key natural communities, evaluate potential habitat suitability for listed plant and animal species, and assess the relative abundance of non-native, invasive species. Wetland boundaries potentially regulated by NYS and/or federal jurisdiction were determined using the technical criteria described in the *Corps Wetland Delineation Manual* (USACE 1987) and the *Regional Supplement to the Corps of Engineers Wetland Delineation Manual: Northcentral and Northeast Regional Supplement* (USACE 2012). In addition, boundaries of freshwater wetlands regulated under Article 24 of the NYECL were delineated according to methods described in the *New York State Freshwater Wetlands Delineation Manual* (Browne et al. 1995).

A description of the coastal and terrestrial habitat in the Project Area is provided below, followed by an evaluation of potential Project-related impacts.

The SRWF is located offshore and, therefore, does not include coastal or terrestrial habitat. Similarly, the SRWEC is predominately located in offshore and NYS waters but will terminate at the Landfall Work Area that is adjacent to coastal habitat in Smith Point County Park. In this section, the term Landfall/ICW Study Area is used to describe an area encompassing the Landfall Work Area (in Smith Point County Park on Fire Island), the adjacent HDD conduit stringing area, the ICW Work Area (in Smith Point County Park and in Smith Point Marina on the mainland), as well as the adjacent lands around these areas to allow for the possibility of future design adjustments. The term 'Landfall/ICW Study Area on Fire Island' is used to specifically describe the assessed areas on Fire Island, while the term 'Landfall/ICW Study Area on the Mainland' is used to specifically describe the assessed areas within Smith Point Marina (Figure 4.4.1-1). Finally, subtidal habitats, such as submerged aquatic vegetation, which may occur in the ICW, are addressed in Section 4.4.2. More detailed information concerning coastal and terrestrial habitat, including the results of NYSDEC and USFWS data requests, desktop assessment, and field surveys are presented in Appendix L.

V:\1956\active\Task Owner and other Non-BC\1956\Jobs\2028113199\03_data\gis_cad\gis\mxd\COP\2028113199_4.4.1-1_Landfall.mxd Revised: 2021-05-06 By: gcrapentier

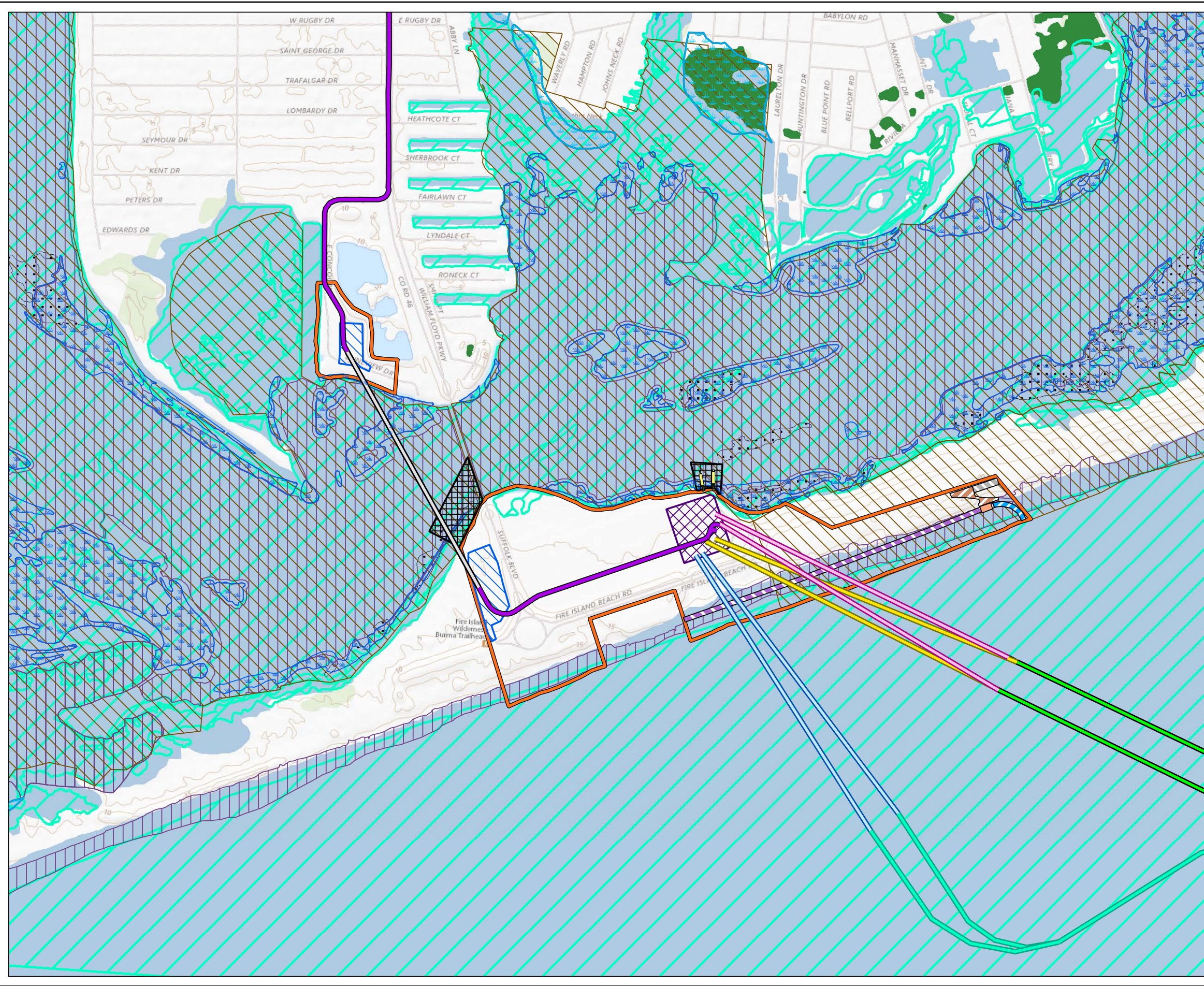

Figure 4.4.1-1
Landfall/ICW Study Area

Sunrise Wind | Powered by Ørsted & Eversource

Legend

- Sunrise Wind Export Cable (SRWEC-NYS)
- SRWEC-NYS (Western Landfall Option)
- Landfall HDD A
- Landfall HDD B
- Landfall HDD C
- Onshore Transmission Cable-LIE Service Road Route
- Landfall/ICW Study Area
- Landfall Work Area
- Potential Temporary Floating Pier
- Temporary Floating Pier Area
- ICW Work Area
- Pipe Welding Area
- Pipe Sea Access
- Pipe Storage
- Pipe Stringing Area
- Indicative Access to Pipe Areas
- NYSEDEC Wetlands
- NYSEDEC Statewide Seagrass
- NYSDOS Seagrass
- NYSEDEC Tidal Wetlands - NYC and Long Island
- NYSDOS Significant Coastal Fish and Wildlife Habitats
- NYS Natural Heritage Community Occurrences
- NWI Wetlands
- Estuarine and Marine Wetlands
- Freshwater Wetlands

Note
Routes are indicative and subject to engineering design changes.

Sources
NYSEDEC, NYSDOS, NYS Natural Heritage Program, NYS GIS Clearinghouse, USFWS

Date	12/18/2020 Revised: 6/1/2021
Project Number	2028113199
Prepared By	GC
Reviewed By	AP

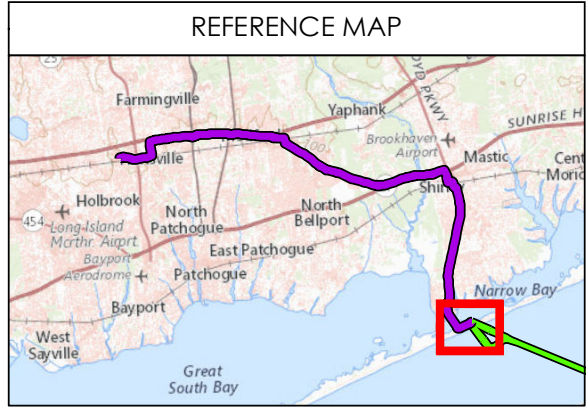
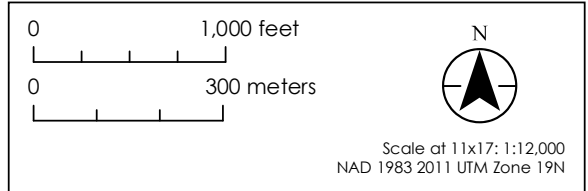

This page intentionally left blank

CONSTRUCTION AND OPERATIONS PLAN

Site Characterization and Assessment of Impacts – Biological Resources

4.4.1.1 Affected Environment

Regional Overview

Central Long Island's coastal and terrestrial environment varies widely and consists of a diversity of habitats. These range from exposed rocky shores and exposed bedrock, sandy coastal beaches, dunes, freshwater and brackish bays and ponds, and salt marshes fringing the shore of sheltered embayments to intertidal mudflats and sandflats (BOEM 2013). The sandy, coastal beaches along the southeastern coastline of Long Island are characterized by four zones: nearshore bottom (submerged areas below mean low water to 29.5 ft [9.0 m]); foreshore (intertidal areas between mean low water to the high tide zone); backshore (exposed sandflats above high tide line to dunes, but occasionally submerged during storms or exceptionally high tides); and dunes (areas of wind-blown sand ridges or mounds above the highest tide line and exposed to wind action) (USFWS 1997). These coastal habitats are constantly changing as a result of wave action and tidal currents which remove, transport, and deposit sediment (DOI-MMS 2007). The primary sources of deposited material, which maintain the sand beaches, is from erosional areas along existing beaches and sand shoals on the inner continental shelf (BOEM 2013). In 2012, Hurricane Sandy's wave energy and storm surge produced extensive coastal erosion along the entirety of Fire Island. Beaches and dunes across the island lost an average of 54 percent of their pre-storm volume with greater than 75 percent volume loss estimated near the Landfall/ICW Study Area on Fire Island (USGS 2013).

On Fire Island, American beachgrass (*Ammophila breviligulata*) is the dominant plant species on foredunes. Beach plum (*Prunus maritima*), bayberry (*Morella pensylvanica*), seaside goldenrod (*Solidago sempervirens*), and poison ivy (*Toxicodendron radicans*) commonly occur on the leeward side (NPS 2015). Interdunal swales, found mostly in the Otis Pike Fire Island High Dune Wilderness Area located west of the Landfall/ICW Study Area on Fire Island, are wetlands that form when blowouts in the dunes intersect the water table and typical wetland plants such as grasses, forbs and woody shrubs become established. Characteristic species of these swale wetlands include purple gerardia (*Agalinis purpurea*), sundews (*Drosera* spp.), cranberry (*Vaccinium macrocarpon*), highbush blueberry (*Vaccinium corymbosum*), and bayberry. Tidal marshes occupy the backside of Fire Island in broad areas where historic storms have overwashed adjacent upland materials. Common species of Fire Island's tidal marshes are cordgrass (*Spartina alterniflora*), salt meadow grass (*Spartina patens*) and spike grass (*Distichlis spicata*) depending on the level of tidal inundation.

On mainland Long Island, residential and industrial development has removed or degraded much of the historical natural communities. One exception is the Central Pine Barrens, an 105,000-acre area of unique forested and wetland habitats protected by the *Long Island Pine Barrens Protection Act* in 1993. In addition, the headwaters for the Carmans River, which intersects with the Onshore Transmission Cable route and is one of the four major rivers on Long Island, is located in the Central Pine Barrens. The river is freshwater where the Onshore Transmission Cable route crosses along Victory Avenue, with brackish conditions beginning approximately 2,500 ft (762 m) downstream where a railroad crossing is located.

CONSTRUCTION AND OPERATIONS PLAN

Site Characterization and Assessment of Impacts – Biological Resources

Onshore Facilities

The Landfall/ICW Study Area on Fire Island, where the Landfall Work Area will provide the transition between SRWEC and Onshore Facilities, occupies a paved parking lot at Smith Point County Park, portions of beach along the Atlantic Ocean to the south of William Floyd Parkway, and the vegetated backshore areas along the bay (Figure 4.4.1-1). From the Landfall Work Area, the Onshore Transmission Cable transits through developed areas to the ICW Work Area on Fire Island, under the ICW via HDD to the ICW Work Area on the Mainland. For the purposes of the below analysis, discussion of Great South Bay was also included where applicable, as habitats within Great South Bay are representative of the hydrologically connected and immediately adjacent ICW.

The Onshore Facilities are generally located within existing ROWs and/or industrial areas. The Onshore Transmission Cable will generally be routed within the paved portion of existing road ROW and will cross the Carmans River via HDD before reaching the Union Avenue Site. The Union Avenue Site is primarily a developed industrial/commercial site with small narrow forested areas along parcel boundaries. The Onshore Interconnection Cable is also located generally within the paved portion of the existing roadway ROW and utility-owned or controlled property.

SCFHW, Significant Natural Communities and RTE Plants

SCFHW and Significant Natural Communities are shown in Figure 4.4.1-2. The primary agency sources used to evaluate rare, threatened and endangered (RTE) species include New York Natural Heritage Program (NYNHP) Project-specific inquiry response letters dated March 27, 2020 and April 15, 2021, and an Official Species List provided by the USFWS generated through use of USFWS's Information for Planning and Consultation (IPaC) database review on March 11, 2020 and on April 19, 2021. Meetings with NYSDEC and USFWS also informed the existing conditions and assessment of potential impacts. Table 4.4.1-1 summarizes the known RTE plant occurrences and potential habitat for those species associated with the Onshore Facilities components based on desktop review and field surveys.¹⁶ State and/or federally listed avian and bat species associated with Onshore Facilities are addressed in Sections 4.4.6 and 4.4.7, respectively. To date, no RTE species have been observed within the surveyed portions of the Onshore Facilities during field visits, and while the Interconnection Route were not visited, the presence of RTE species here is unlikely given the industrial and commercial nature of these areas.

¹⁶ Field surveys for RTE plants evaluated the potential for suitable habitat within the Onshore Facilities and were not targeted surveys to determine potential presence / probable absence of species.

Figure 4.4.1-2 Significant and Critical Natural Communities and Habitats

**Sunrise
Wind** | Powered by
Ørsted &
Eversource

- Legend**
- Sunrise Wind Farm (SRWF)
 - Sunrise Wind Export Cable (SRWEC-OCS)
 - Sunrise Wind Export Cable (SRWEC-NYS)
 - SRWEC-NYS (Western Landfall Option)
 - Landfall HDD A
 - Landfall HDD B
 - Landfall HDD C
 - Intracoastal Waterway HDD (ICW HDD)
 - Onshore Transmission Cable-LIE Service Road Route
 - Onshore Interconnection Cable Route
 - Union Avenue Site
 - Holbrook Substation
 - NYSDOS Significant Coastal Fish and Wildlife Habitat
 - NYS Natural Heritage Community Occurrences
 - NYSDEC Statewide Seagrass
 - NYSDEC 2018 Long Island South Shore Estuary Benthic Habitat
 - NYSDEC Critical Environmental Areas Coastal Zone Area South
 - Pine Barren Core Area
 - Pine Barren Compatible Growth Area
- Note**
Routes are indicative and subject to engineering design changes.
- Sources**
NYSDEC, NYSDOS, NYS Natural Heritage Program, NYS GIS Clearinghouse, Suffolk County GIS

Date	12/18/2020 Revised: 6/1/2021
Project Number	2028113199
Prepared By	PB
Reviewed By	LJ

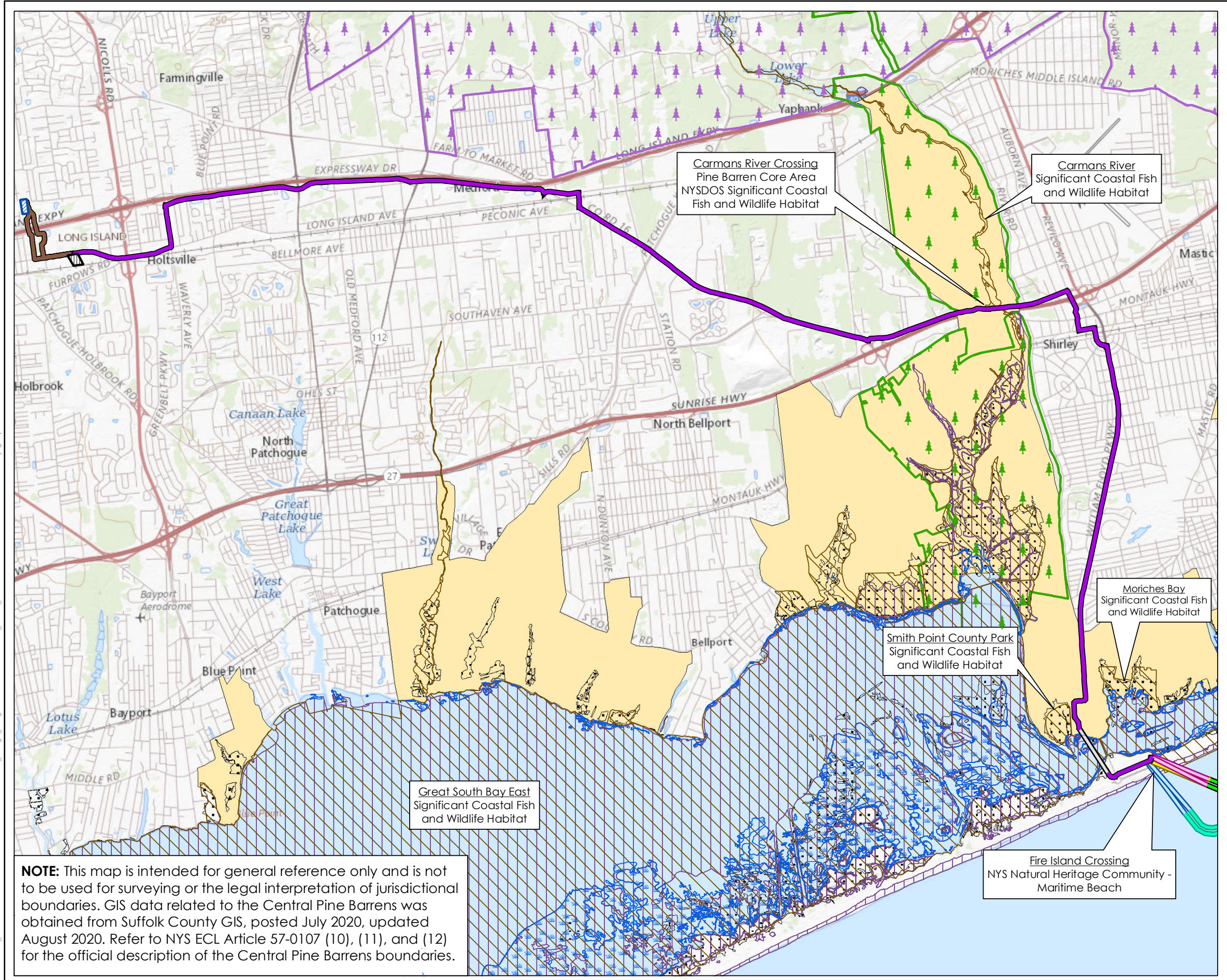
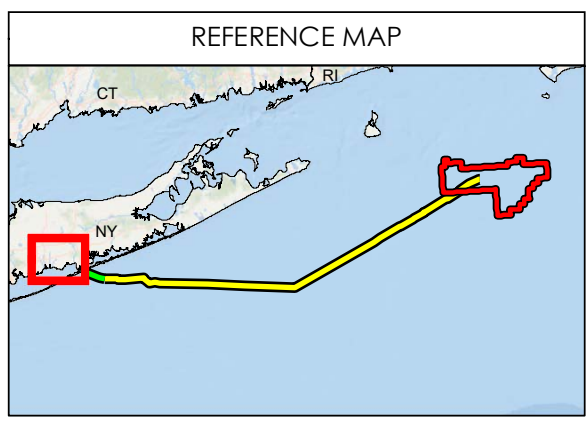
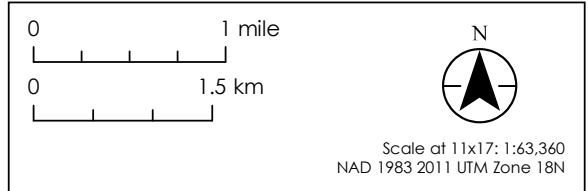

NOTE: This map is intended for general reference only and is not to be used for surveying or the legal interpretation of jurisdictional boundaries. GIS data related to the Central Pine Barrens was obtained from Suffolk County GIS, posted July 2020, updated August 2020. Refer to NYS ECL Article 57-0107 (10), (11), and (12) for the official description of the Central Pine Barrens boundaries.

This page intentionally left blank

CONSTRUCTION AND OPERATIONS PLAN

Site Characterization and Assessment of Impacts – Biological Resources

Table 4.4.1-1 RTE and NYS Watch List Plant Species Documented by NYSDEC or USFWS within the Vicinity of Onshore Facilities and Occurrence Based on Field Surveys

Project Component	Species	State Listing	Federal Listing	Habitat Association	Approximate Location ²	Field Results ³
Landfall/ICW Study Area	Sandplain Gerardia ¹ <i>Agalinis acuta</i>	Endangered	Endangered	Maritime grassland and shrubland	No location information provided	None observed; potential habitat at Landfall/ICW Study Area but outside of Landfall Work Area and ICW Work Area
	Seabeach Amaranth ¹ <i>Amaranthus pumilus</i>	Threatened	Threatened	Maritime beach	No location information provided	None observed; potential habitat at Landfall/ICW Study Area but outside of Landfall Work Area and ICW Work Area
Onshore Transmission Cable Study Area: LIE Service Road Route	Blunt-lobed Grape Fern ² <i>Botrychium oneidense</i>	Threatened	--	Floodplain forest, Red Maple – Blackgum Swamp	Southaven County Park, within 0.2 mi (0.3 km) of Onshore Transmission Cable; in wet soil under shrubs and vines in red maple swamp	None observed; potential habitat in wetlands within Onshore Transmission Cable Study Area associated with Carmans River and Southaven County Park but outside of proposed work areas
	Collins' Sedge ² <i>Carex collinsii</i>	Endangered	--	Red Maple – Blackgum Swamp	Southaven County Park, within 0.2 mi (0.3 km) of Onshore Transmission Cable; abandoned fish hatchery in a red maple-tupelo swamp	None observed; potential habitat in wetlands within Onshore Transmission Cable Study Area associated with Carmans River and Southaven County Park but outside of proposed work areas
	Water Pigmyweed ² <i>Crassula aquatica</i>	Endangered	--	Freshwater intertidal mudflat, freshwater intertidal shore, and freshwater tidal marsh	Within 0.2 mi (0.3 km) of Onshore Transmission Cable; Carmans River, west side immediately south of Montauk Highway; bank of an intertidal section of river at a road embankment	None observed; potential habitat in Carmans River but outside of proposed work areas
	Sandplain Wild Flax ² <i>Linum intercursum</i>	Threatened	--	Maritime dunes, maritime grassland, maritime shrubland, and pitch pine-scrub oak barrens	Within 0.6 mi (1.0 km) of Onshore Transmission Cable: Station Avenue roadside; plants are on a pine barrens roadside with very sparse vegetation, dominated by grasses and legumes	None observed; minimal potential habitat with the possible exception of a remnant open sandy pine barren community present on Revilo Avenue within proposed work areas

NOTE:

¹ Source: USFWS Information for Planning and Consultation (IPaC). Accessed March 11, 2020 and April 19, 2021.

² Source: New York Natural Heritage Program Letters, March 27, 2020 and April 15, 2021.

³ Field surveys for RTE plants evaluated the potential for suitable habitat within the Onshore Facilities and were not targeted surveys to determine potential presence / probable absence of species.

This page intentionally left blank

CONSTRUCTION AND OPERATIONS PLAN

Site Characterization and Assessment of Impacts – Biological Resources

New York State SCFWH, also identified during NYSDEC's Project review, are shown in Figure 4.4.1-2 and are also presented in Table 4.4.1-2 in relation to the Landfall/ICW Study Area, Onshore Transmission Cable, Union Avenue Site, and Onshore Interconnection Cable. SCFWHs are NYSDOS-designated special coastal and terrestrial habitat areas that are mapped and presented with a technical narrative providing site-specific information (NYSDOS 1984). The habitat narrative constitutes a record of the basis for the SCFWH's designation and provides specific information regarding the fish and wildlife resources that depend on the area. SCFWHs are provided protection through state regulations including the *Tidal Wetlands Act* (Article 25), *Freshwater Wetland Act* (Article 24), Protection of Waters Program (Article 15) and Wild, Scenic and Recreational Rivers System (Article 15, Title 27). There are four SCFWHs associated with the Onshore Facilities: Great South Bay-East, Smith Point County Park, Moriches Bay, and Carmans River; and four NYNHP Significant Natural Communities associated with the Onshore Facilities: Red Maple – Blackgum Swamp, Maritime Beach and Maritime Intertidal Gravel/Sand Beach, Marine Eelgrass Meadow, and Marine Back-barrier Lagoon (Table 4.4.1-2).

Table 4.4.1-2 NYSDOS Significant Coastal Fish and Wildlife Habitats and NYNHP Significant Natural Communities

Project Element	SCFWH	NYNHP Significant Natural Communities
Landfall/ICW Study Area	Smith Point County Park, Great South Bay-East (adjacent), Moriches Bay (adjacent)	Maritime Beach and Maritime Intertidal Gravel/Sand Beach, Marine Eelgrass Meadow (adjacent), Marine Back-barrier Lagoon (adjacent)
Onshore Transmission Cable	Carmans River	Red Maple – Blackgum Swamp (located 300 ft [91 m] downstream on other side of Sunrise Highway)
Union Avenue Site	None	None
Onshore Interconnection Cable	None	None

The Landfall/ICW Study Area on the Mainland largely consists of a developed, paved parking lot and includes areas of beach and dune communities along the side and to the west and east of the parking lot. Coastal habitats associated with the Landfall/ICW Study Area on the Mainland include beach and dune communities located along the south side of the mainland and associated interdunal areas. Coastal habitats here are in the Coastal Zone Area South Critical Environmental Area (CEA). This area has been designated by the Town of Brookhaven to protect public health, open space, and wetlands. The Onshore Facilities within this CEA have been largely located within existing developed areas including parking lots and paved roadways.

Coastal habitats associated with the Landfall Work Area and ICW Work Area include the habitats from the ocean inland, including foreshore, backshore, dune, and interdunal areas at the Landfall/ICW Study Area on Fire Island and on the Mainland (Figure 4.4.1-4). These habitats provide nesting and feeding areas for beach-nesting birds (as referenced in Section 4.4.6) in addition to rare beach and dune communities and plants. Where the SRWEC makes landfall at the Landfall HDD TJB, all proposed cable routes intersect with Maritime Beach, a rare and significant NYS coastal natural community.

CONSTRUCTION AND OPERATIONS PLAN

Site Characterization and Assessment of Impacts – Biological Resources

Additionally, HDD conduit stringing may be assembled on the beach; this action would require welding and short-term placement (i.e., 2–3 weeks per duct) of assembled HDD conduit sections in approximately 3,500 ft (1,067 m) of coastal habitats (including Maritime Beach) before installation via HDD. Maritime Beach is a sparsely vegetated community. It occurs on unstable sand, gravel, or cobble shores above the mean high tide line and is continually modified through wave and wind action (NYSDEC 2008b; Edinger et al. 2014).

The terminus of each Landfall is located in developed areas of the Smith Point County Park parking lot or associated surface roads. If assembled on the beach, HDD conduit stringing activities would occur within the Smith Point County Park SCFWH.

The Smith Point County Park SCFWH is identified as one of the largest segments of an undeveloped barrier beach ecosystem on Long Island and provides feeding and nesting habitat for several RTE avian species and supports populations of RTE plant species such as seabeach amaranth (*Amaranthus pumilus*) and seabeach knotweed (*Polygonum glaucum*). The dunes also comprise a significant segment of the fall migration corridor for raptors (NYSDEC 2008a).

The Moriches Bay SCFWH abuts the bayside of the Landfall/ICW Study Area on Fire Island. It is identified as one of the largest, protected, shallow, coastal bays in New York State and provides feeding and nesting habitat for several RTE avian species and supports significant concentrations of wintering waterfowl in New York State. It is a highly productive bay and supports regionally significant habitat for fish and shellfish, migrating and wintering waterfowl, colonial nesting waterbirds, beach-nesting birds, migratory shorebirds, raptors, and rare plants (NYSDEC 2008b).

The Great South Bay–East SCFWH abuts the ICW Study Area. It is identified as the largest protected, shallow, coastal bay in New York State and provides feeding and nesting habitat for several RTE avian species and supports one of the largest concentrations of wintering waterfowl in New York State (NYSDEC 2008c).

Waterbodies

One coastal waterbody, the ICW, is intersected by the ICW HDD as it transits between the ICW Work Area on Fire Island and the ICW Work Area on the Mainland (Figure 4.4.1-3). In addition, the Onshore Transmission Cable will traverse the Carmans River (Figure 4.4.1-3). Details on these jurisdictional features are provided in Table 4.4.1-3 and additional information is available in Appendix L. Waterbodies were not documents in other areas of the

Tidal Wetlands

Coastal tidal wetlands under Article 25 of the NYECL are those areas which border on or lie beneath tidal waters, such as, but not limited to, banks, bogs, salt marsh, swamps, meadows, flats, or other low lands subject to tidal action, including those areas now or formerly connected to tidal waters. In addition, per 6 NYCRR Part 661.4, adjacent areas up to 300 ft (91.4 m) inland from the tidal wetland boundary are regulated.

The ICW HDD will cross under several NYSDEC-designated tidal wetland categories in the Great South Bay–East SCFWH, including Littoral Zone and Coastal Shoals, Bars, and Mudflats before reaching the ICW HDD Work Area at Smith Point Marina. These tidal wetlands are also mapped by the NWI as estuarine wetlands (E1AB3L, E1UBL, and E2U5N).

CONSTRUCTION AND OPERATIONS PLAN

Site Characterization and Assessment of Impacts – Biological Resources

The Landfall/ICW Study Area on Fire Island is adjacent to (i.e., within 300 ft [91.4 m] of) coastal tidal wetlands as mapped by the NYSDEC including Littoral Zone and Coastal Shoals, Bars, and Mudflats wetland categories within the ICW. The ICW HDD will be located underneath tidal wetlands as mapped by the NYSDEC including Littoral Zone and Coastal Shoals, Bars, and Mudflats wetland categories within the ICW. The Landfall/ICW Study Area on the Mainland is adjacent to mapped Littoral Zone, Intertidal Marsh, and High Marsh tidal wetlands to the west of the site.

Field surveys delineated three tidal wetlands associated with the Landfall/ICW Study Area on Fire Island. Details on these jurisdictional features are provided in Table 4.4.1-3 and additional information is located in Appendix L.

- **Wetland W-01ASA** is characterized as an estuarine, intertidal wetland system (E1SS/EM) dominated by common reed (*Phragmites australis*), rambler rose (*Rosa multiflora*) and Jesuit's-bark (*Iva frutescens*) and is consistent with the NWI classification. This wetland is located along the northeastern edge of the Smith Point County Park on the backslope of Fire Island abutting Great South Bay. The eastern portion of this feature overlaps with the Smith Point County Park SCFWH unit.
- **Wetland W-01ASB** is characterized as an estuarine, intertidal wetland system (E1SS/EM) dominated by groundsel tree (*Baccharis halimifolia*), common reed, rambler rose and Jesuit's-bark and is consistent with the NWI classification. This wetland is located along the northeastern edge of the Smith Point County Park on the backslope of Fire Island abutting Great South Bay.

Wetland W-01CFA. is an estuarine, intertidal wetland system (E1SS/EM) dominated by Jesuit's-bark, northern bayberry, and common reed. This wetland is located along the north edge of the Smith Point County Park on the backslope of Fire Island abutting Great South Bay.

CONSTRUCTION AND OPERATIONS PLAN

Site Characterization and Assessment of Impacts – Biological Resources

Table 4.4.1-3 Summary of Wetland and Waterbody Resources Observed for Onshore Facilities

Project Component		Mapped Wetland and Waterbody Resources Documented via Desktop Review	Wetland and Waterbody Resources Identified in Field Survey
Landfall/ICW Study Area	Landfall Work Area	Wetlands <ul style="list-style-type: none"> NYSDEC-mapped tidal wetlands (adjacent area) NYSDEC-mapped estuarine wetlands (adjacent area) 	Delineated Wetlands <ul style="list-style-type: none"> Estuarine (W-01ASA, W-01ASB, and W-01CFA)
		Waterbodies <ul style="list-style-type: none"> Atlantic Ocean (adjacent area) Great South Bay (adjacent area) 	Delineated Waterbodies <ul style="list-style-type: none"> None
	ICW Work Area	Wetlands <ul style="list-style-type: none"> NYSDEC-mapped tidal wetlands (adjacent area) NYSDEC-mapped estuarine wetlands (adjacent area) 	Delineated Wetlands <ul style="list-style-type: none"> Palustrine (W-01ASC, and W-01CFB)
		Waterbodies <ul style="list-style-type: none"> Narrow Bay (adjacent area) 	Delineated Waterbodies <ul style="list-style-type: none"> None
Onshore Transmission Cable		Wetlands <ul style="list-style-type: none"> NYSDEC-mapped freshwater wetlands associated with Carmans River NWI-mapped wetlands at Carmans River 	Delineated Wetlands <ul style="list-style-type: none"> Palustrine (W-01CFC/01JRB and W-01CFD/01JRA) near Carmans River
		Waterbodies <ul style="list-style-type: none"> Carmans River 	Delineated Waterbodies <ul style="list-style-type: none"> Watercourse S-01CF (Carmans River) Watercourse S-02MA (tributary to Carmans River)
Union Avenue Site		Wetlands and Waterbodies <ul style="list-style-type: none"> None 	Wetlands and Waterbodies <ul style="list-style-type: none"> None
Onshore Interconnection Cable		Wetlands and Waterbodies <ul style="list-style-type: none"> NWI-mapped wetland 	Wetlands and Waterbodies <ul style="list-style-type: none"> Results Pending Survey Access Permission

V:\1956\active_Task Owner and other Non-BC\1956_Jobs\2028113199_03_data\gis_ced\gis\Map\XDs\COP\2028113199_4.4.1-3_CoastalWetland.mxd Revised: 2021-05-07 By: gcarpentier

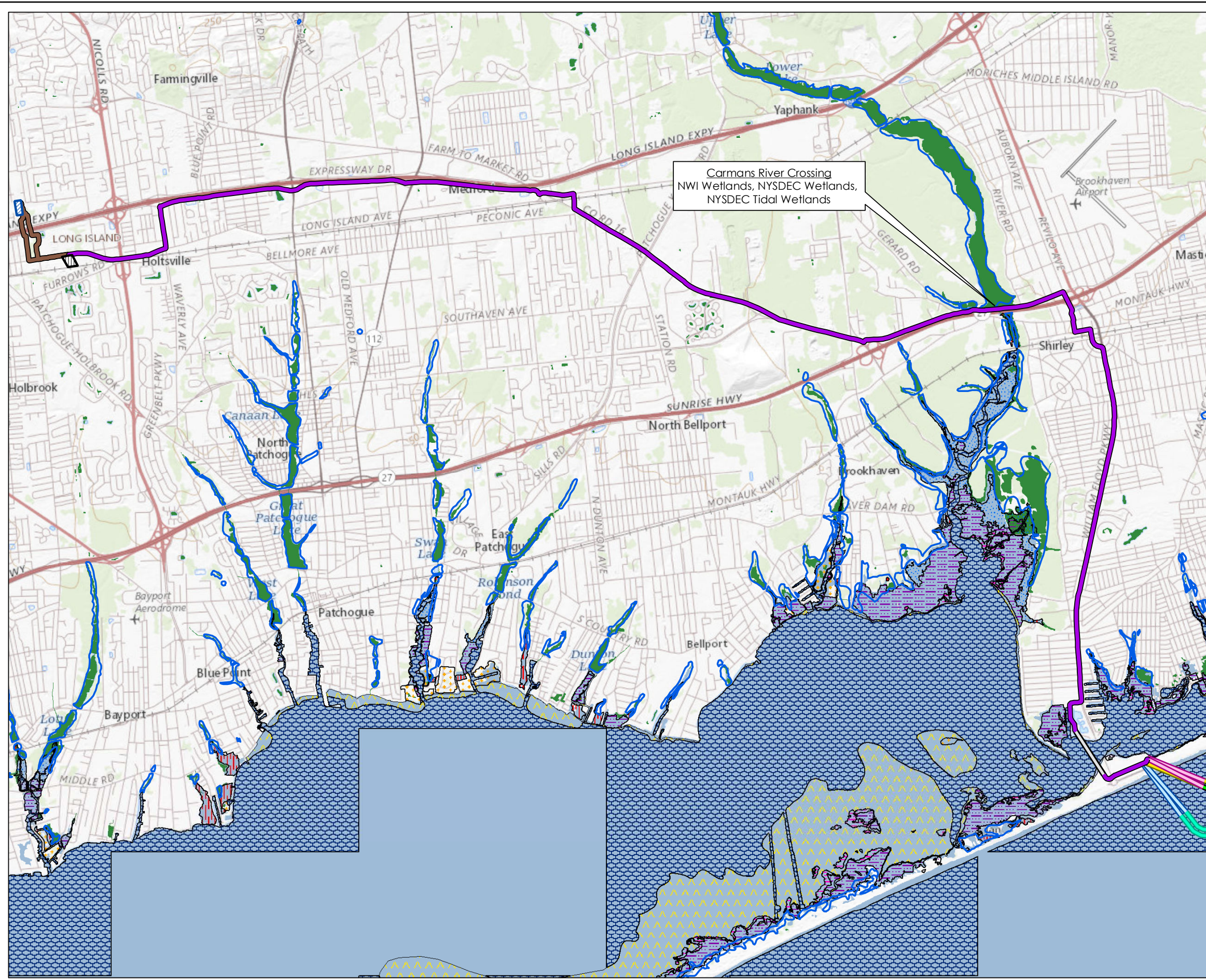

**Figure 4.4.1-3
Wetlands and Waterbodies**

Sunrise Wind | Powered by Ørsted & Eversource

Legend

- Sunrise Wind Farm (SRWF)
- Sunrise Wind Export Cable (SRWEC-OCS)
- Sunrise Wind Export Cable (SRWEC-NYS)
- SRWEC-NYS (Western Landfall Option)
- Landfall HDD A
- Landfall HDD B
- Landfall HDD C
- Intracoastal Waterway HDD (ICW HDD)
- Onshore Transmission Cable-LIE Service Road Route
- Onshore Interconnection Cable Route
- Union Avenue Site
- Holbrook Substation
- NYSDEC Tidal Wetlands NYC and Long Island
- NYC and Long Island NWI Wetlands
- Dredged Spoil
- Formally Connected
- Fresh Marsh
- High Marsh
- Intertidal Marsh
- Littoral Zone
- Coastal Shoals, Bars and Mudflats
- NYSDEC Wetlands
- NYC and Long Island NWI Wetlands
- Estuarine and Marine Wetlands
- Freshwater Wetlands

Note
Routes are indicative and subject to engineering design changes.

Sources
NYSDEC, NYS GIS Clearinghouse, USFWS

Date	12/18/2020 Revised: 6/1/2021
Project Number	2028113199
Prepared By	PB
Reviewed By	AP

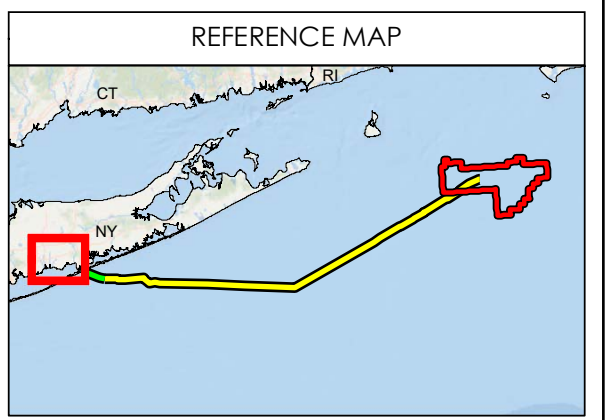
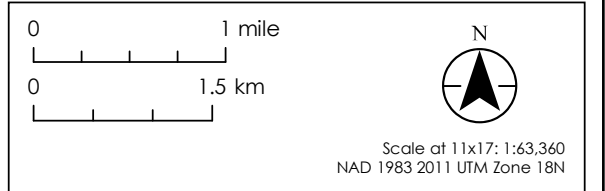

This page intentionally left blank

CONSTRUCTION AND OPERATIONS PLAN

Site Characterization and Assessment of Impacts – Biological Resources

Freshwater Wetlands

The Onshore Transmission Cable will traverse NYSDEC-regulated freshwater wetlands at the Carmans River (Figure 4.4.1-3, Table 4.4.1-4 and Appendix L).

At the Carmans River crossing, wetlands are designated as forested and freshwater pond (PFO1E and PUBHh) by NWI and as Class 1 wetlands by NYSDEC. Although NYSDEC did not identify in their response, Carmans River is mapped as a SCFWH, and is used by rare listed species, including peregrine falcon (*Falco peregrinus*), eastern tiger salamander (*Ambystoma tigrinum*), eastern box turtle (*Terrapene carolina*), osprey (*Pandion haliaetus*), and potentially pied-billed grebe (*Podilymbus podiceps*). The river also supports concentrations of sea-run brown trout (*Salmo trutta*) and wild brook trout (*Salvelinus fontinalis*) in some segments of the river (NYSDEC 2008d).

One NWI-mapped seasonally flooded, palustrine emergent persistent wetland (PEM1A) is located approximately 170 ft (52 m) east of the Interconnection Cable Route. This wetland is not mapped as a NYS-regulated wetland.

Based on a review of available spatial data, there are no mapped NYSDEC-regulated freshwater wetlands or NWI wetlands along other areas of the Landfall/ICW Study Area, Onshore Transmission Cable, at the Union Avenue Site, or along the Onshore Interconnection Cable.

Field surveys resulted in the delineation of two freshwater wetlands associated with the Landfall/ICW Study Area on the Mainland, as well as two freshwater watercourses, two freshwater waterbodies, and five freshwater wetlands associated with the Onshore Transmission Cable route. Details on these jurisdictional features is provided in Table 4.4.1-4 and additional information is located in Appendix L.

Landfall/ICW Study Area on the Mainland:

- **Wetland W-01ASC** is a palustrine (freshwater), man-made basin dominated by common reed (PEM). Additional species of vegetation include eastern poison ivy. This wetland is located several hundred feet inland from the northern shore of Great South Bay at the Smith Point County Park on the mainland and consists of two manmade catchment areas surrounded by boat launch parking. The northern and southern basins are bisected by an asphalt travel lane in the parking area that may provide overland surface flow during extreme rain events. This feature occurs within the Town of Brookhaven Coastal Zone Area South CEA unit.
- **Wetland W-01CFB** is a palustrine (freshwater), man-made basin dominated by common reed (PEM). This wetland is located on the southeastern shore of Great South Bay at the Smith Point County Park on the mainland, along the edge of the survey area. This feature occurs within the Town of Brookhaven Coastal Zone Area South CEA unit.

Onshore Transmission Cable route:

- **Watercourse S-01GP** is the Carmans River, a perennial freshwater river (R2UBH). Within the Victory Avenue survey area, the banks of the Carmans River have been channelized as a result of historic roadway construction. The river channel originates at a small dam at the outlet of waterbody 01GPA. The river ranges from approximately 40 to 60 ft wide within the delineation area and a fish ladder is present at the dam location.

CONSTRUCTION AND OPERATIONS PLAN

Site Characterization and Assessment of Impacts – Biological Resources

- **Watercourse S-10MA** is a perennial watercourse (R2UB2) flowing to the southeast from wetland W-10MAA into waterbody WB-01GPA in Southaven County Park. It is approximately 10 ft wide with sandy substrate. It contained approximately 6 to 8 in of water at the time of the delineation and had bank heights of approximately 1.5 ft.
- **Waterbody WB-10MAA** is a palustrine (freshwater) unconsolidated bottom (PUB) pond in Southaven County Park. It is an open waterbody. It was unvegetated at the time of the March 2021 field survey but likely supports non-persistent submerged and emerged macrophytes. Small, unidentified fish were observed at the time of the delineation.
- **Waterbody WB-01GPA** consists of a large impounded lacustrine waterbody with an unconsolidated bottom (L2UB2/3) associated with the Carmans River. The southern portion of the waterbody within the delineation area consists of generally shallow water habitats, approximately less than 10 ft deep. Aquatic vegetation observed at the time of the delineation included persistent patches of swamp-loosestrife (*Decodon verticillatus*).
- **Wetland W-10MAB** is a palustrine (freshwater) scrub-shrub (PSS1E) wetland in a confined basin located to the south of wetland W-10MAA in Southaven County Park. Dominant and characteristic shrubs include clammy azalea (*Rhododendron viscosum*) and highbush blueberry. Herbaceous plants were sparse at the time of the field visit but included scattered emerging individuals of skunk-cabbage (*Symplocarpus foetidus*).
- **Wetland W-10MAC** is a palustrine (freshwater) forested (PFO1E) wetland located to the west of wetland 10MAA in Southaven County Park. It is dominated by trees of black tupelo (*Nyssa sylvatica*) and red maple (*Acer rubrum*) with a shrub stratum dominated by highbush blueberry, clammy azalea, and coastal sweet-pepperbush (*Clethra alnifolia*). Herbaceous plants were sparse at the time of the field survey and included emerging individuals of skunk-cabbage.
- **Waterbody WB-10MAA** is a palustrine (freshwater) unconsolidated bottom (PUB) pond in Southaven County Park. It is an open waterbody. It was unvegetated at the time of the March 2021 field survey but likely supports non-persistent submerged and emerged macrophytes. Small, unidentified fish were observed at the time of the delineation.
- **Waterbody WB-01GPA** consists of a large impounded lacustrine waterbody with an unconsolidated bottom (L2UB2/3) associated with the Carmans River. The southern portion of the waterbody within the delineation area consists of generally shallow water habitats, approximately less than 10 ft deep. Aquatic vegetation observed at the time of the delineation included persistent patches of swamp-loosestrife (*Decodon verticillatus*).
- **Wetland W-01GPA** is a small palustrine (freshwater) forested (PFO1E) wetland located in the southwest portion of waterbody WB-01GPA. This wetland is dominated by red maple trees and coastal sweet-pepperbush shrubs.
- **Wetland W-01GPB** is a small floodplain palustrine (freshwater) forested (PFO1E) wetland along the southeastern edge of waterbody WB-01GPA. The wetland includes a canopy dominated by red maple and American elm (*Ulmus americana*) trees. The understory is sparse and consists of small patches of horsebrier (*Smilax rotundifolia*).

CONSTRUCTION AND OPERATIONS PLAN

Site Characterization and Assessment of Impacts – Biological Resources

- **Wetland W-01GPC** is a palustrine (freshwater) forested (PFO1E) wetland located between Victory Avenue and Route 27. Hydrology is provided primarily by surface water runoff from the neighboring roadway surfaces. The wetland includes a canopy dominated by red maple trees. Understory species include smooth arrow-wood (*Viburnum recognitum*) and maleberry (*Lyonia ligustrina*). Herbaceous species observed at the time of the delineation include lamp rush (*Juncus effusus*), cinnamon fern (*Osmundastrum cinnamomeum*), and tussock sedge (*Carex stricta*).

Invasive Plant Habitats

Land adjacent to the Landfall/ICW Study Area on the Mainland, the Onshore Transmission Cable route, the Union Avenue Site, and Onshore Interconnection Cable route largely consist of developed residential, commercial, utility or industrial land uses. Based both on proximity of the Onshore Facilities to areas that have been previously disturbed and on a query of the New York iMap Invasives iMAP3, exotic, terrestrial and wetland invasive plant species have been previously documented along the Onshore Transmission Cable route and near the Union Avenue Site. Documented invasive plant species from the iMap Invasives iMAP3 query include tree-of-heaven (*Ailanthus altissima*), Japanese barberry (*Berberis thunbergii*), European privet (*Ligustrum vulgare*), purple loosestrife (*Lythrum salicaria*), mile-a-minute weed (*Persicaria perfoliata*), Japanese knotweed (*Fallopia japonica*), and rambler rose.

Field surveys confirmed that invasive species are widespread throughout the Onshore Facilities, consistent with findings from the iMap Invasives query. Mugwort (*Artemisia vulgaris*) was the most prevalent species observed and commonly occurs along road shoulders throughout the Onshore Facilities. Large concentrations of common reed were observed along the backside of Fire Island and at Smith Point Marina at the Landfall Study Area. Commonly observed species along the Onshore Transmission Cable in addition to mugwort included Japanese honeysuckle (*Lonicera japonica*), oriental bittersweet (*Celastrus orbiculatus*), rambler rose, and Norway maple (*Acer platanoides*). See Appendix L for the complete list of observed invasive species and figures detailing specific occurrences.

Floodplains

FEMA is responsible for flood hazard mapping to assess flood risk to infrastructure and guide mitigative actions. Based on FEMA's Flood Insurance Rate Maps (FIRM), the entirety of the Landfall/ICW Study Area is located within the 100-year floodplain (Zone AE; the area with a 1 percent annual chance of flooding; FIRM panel 36103C0951H). Beach and dune portions of the Landfall/ICW Study Area on Fire Island located oceanside of the William Floyd Parkway and a portion of the ICW HDD are designated as coastal flood zones with velocity (i.e., wave action) hazard (Zone VE; FIRM panel 36103C0951H). Flood elevations for the 100-year flood zones within the Landfall/ICW Study Area range from 6 to 17 ft (1.8 to 5.2 m) North American Vertical Datum of 1988 (NAVD88).

CONSTRUCTION AND OPERATIONS PLAN

Site Characterization and Assessment of Impacts – Biological Resources

Approximately 1,800 ft (549 m) of the Onshore Transmission Cable is located within the 100-year floodplain (Zone AE) along William Floyd Parkway as it exits Smith Point Marina (FIRM panel 36103C0951H). Another 1,900 ft (745 m) of the Onshore Transmission Cable is within the 100-year floodplain at the Carmans River crossing, although base flood elevation data does not exist at this location (Zone A; FIRM panel 36103C0717H). All other portions of the Onshore Transmission Cable route and the Union Avenue Site are in areas of minimal flood hazard. Additional details on the locations of mapped floodplains is provided in Appendix L.

CONSTRUCTION AND OPERATIONS PLAN

Site Characterization and Assessment of Impacts – Biological Resources

Table 4.4.1-4 Summary of Coastal and Terrestrial Habitats Observed for Onshore Facilities

Project Component	Mapped Wetland Resources	Mapped Waterbody Resources	Delineated Resources in Study Area	Mapped SCFWH	Mapped NYNHP Significant Natural Communities	Results from Field Surveys of Study Area
Landfall/ICW Study Area	<ul style="list-style-type: none"> NYSDEC-mapped tidal wetlands (adjacent) NYSDEC-mapped estuarine wetlands (adjacent) 	<ul style="list-style-type: none"> Great South Bay (adjacent) Atlantic Ocean (adjacent) 	<p>Waterbodies</p> <ul style="list-style-type: none"> None <p>Wetlands</p> <ul style="list-style-type: none"> Estuarine (W-01ASA, W-01ASB, and W-01CFA) Palustrine (W-01ASC and W-01CFB) 	<ul style="list-style-type: none"> Smith Point County Park Great South Bay-East (adjacent) Moriches Bay (adjacent) 	<ul style="list-style-type: none"> Maritime Beach and Maritime Intertidal Gravel/Sand Beach Marine Eelgrass Meadow (adjacent) Marine Back-barrier Lagoon (adjacent) 	<ul style="list-style-type: none"> Smith Point County Park Great South Bay-East (adjacent) Moriches Bay (adjacent) Maritime Beach and Maritime Intertidal Gravel/Sand Beach
Onshore Transmission Cable—LIE Service Road Route	<ul style="list-style-type: none"> NYSDEC-mapped freshwater wetlands at and adjacent to Carmans River crossing NWI-mapped wetlands at Carmans River crossing 	<ul style="list-style-type: none"> Carmans River 	<p>Watercourses</p> <ul style="list-style-type: none"> Palustrine (WB-10MAA, WB-01GPA,) near Carmans River and Southaven County Park <p>Waterbodies</p> <ul style="list-style-type: none"> S-01GP (Carmans River) S-10MA <p>Wetlands</p> <ul style="list-style-type: none"> Palustrine (W-10MAB, W-10MAC, W-01GPA, W-01GPB, W-01GPC) near Carmans River and Southaven County Park 	<ul style="list-style-type: none"> Carmans River 	<ul style="list-style-type: none"> Red Maple – Blackgum Swamp (300 ft [91 m] downstream on either side of Sunrise Highway) 	<ul style="list-style-type: none"> Carmans River
Union Avenue Site	<ul style="list-style-type: none"> None 	<ul style="list-style-type: none"> None 	<ul style="list-style-type: none"> None 	<ul style="list-style-type: none"> None 	<ul style="list-style-type: none"> None 	<ul style="list-style-type: none"> None
Onshore Interconnection Cable	<ul style="list-style-type: none"> NWI-mapped freshwater wetland (adjacent) 	<ul style="list-style-type: none"> None 	<ul style="list-style-type: none"> Pending access permissions for field surveys 	<ul style="list-style-type: none"> None 	<ul style="list-style-type: none"> None 	<ul style="list-style-type: none"> Pending access permissions for field surveys

CONSTRUCTION AND OPERATIONS PLAN

Site Characterization and Assessment of Impacts – Biological Resources

4.4.1.2 Potential Impacts

Construction, O&M, and decommissioning activities associated with the Onshore Facilities have the potential to cause both direct and indirect impacts on coastal and terrestrial habitat. IPFs associated with the construction and O&M phases of the Project are identified on Figure 4.4.1-4 and described separately, by phase, for the Onshore Facilities in the following sections. For the decommissioning phase of the Project, impacts are anticipated to be similar to or less adverse than those described for construction; therefore, impacts from decommissioning are not addressed separately in this section. Supporting information on impacts to coastal and terrestrial habitat are also presented in further detail in Appendix L.

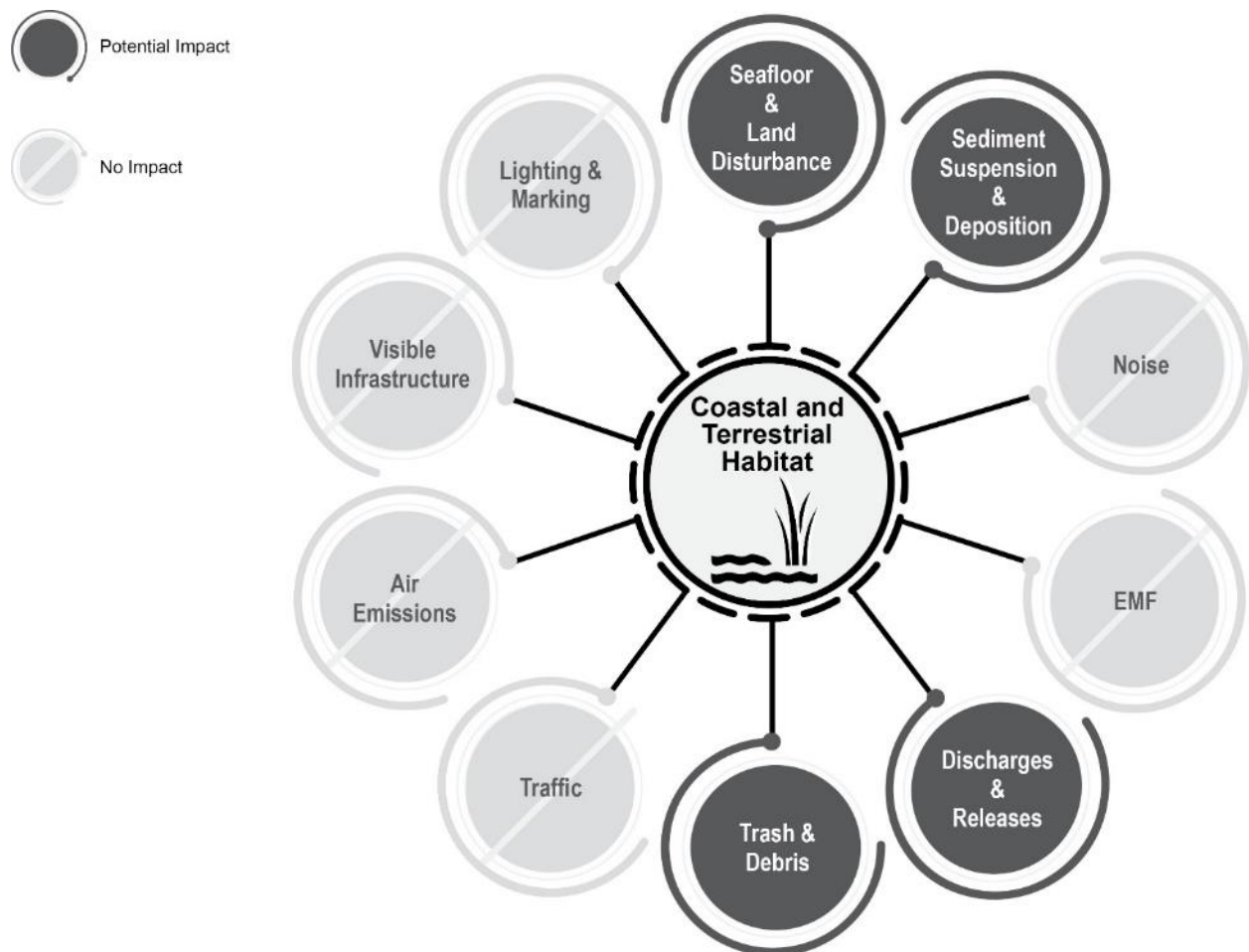

Figure 4.4.1-4 Impact-Producing Factors on Coastal and Terrestrial Habitat

CONSTRUCTION AND OPERATIONS PLAN

Site Characterization and Assessment of Impacts – Biological Resources

Onshore Facilities

The IPFs associated with the Onshore Facilities that could directly or indirectly impact coastal or terrestrial habitat include land disturbance, sediment suspension and deposition, discharges and releases, and trash and debris. These IPFs have the potential to temporarily or permanently affect the condition or function of sensitive resources previously identified. The potential impacts associated with these IPFs for each phase of the Onshore Facilities are addressed separately in the following sections.

Construction

Land Disturbance

Potential direct impacts to coastal and terrestrial habitat during construction of the Onshore Facilities have been avoided and minimized to the maximum practicable extent by locating Project infrastructure primarily in previously disturbed or developed areas (i.e., roadways, ROWs, developed industrial/commercial areas). In those limited instances where direct impacts to NYSDEC-mapped wetlands or their regulated adjacent areas cannot be avoided, it is expected that most of the impacts will be temporary, as the impacted area will be restored to pre-construction conditions to the maximum extent practicable. Construction of Onshore Facilities are not expected to result in changes to the base flood elevation as activity associated with the SRWEC terminus on Fire Island and the Onshore Transmission Cable will be installed via HDD or installed below the existing grade via trenching. Potential direct impacts to benthic communities, Essential Fish Habitat (EFH) and finfish, sea turtles, avian species, and bat species are discussed in Sections 4.4.2 through 4.4.7 and effects of altered coastal habitat from Project activities on sea turtle, avian, and bat species are further described in Sections 4.4.5, 4.4.6, and 4.4.7, respectively.

For the purposes of impact assessment, land disturbance associated with installation of the HDD for the SRWEC–NYS in the Landfall Work Area between the Mean High Water Line (as defined by the USACE [(33 CFR 329)]) and the TJBs is described further below. The anticipated impacts of Onshore Facilities on wetlands and waterbodies are depicted in Table 4.4.1-5.

CONSTRUCTION AND OPERATIONS PLAN

Site Characterization and Assessment of Impacts – Biological Resources

Table 4.4.1-5 Anticipated Impacts to Waterbodies or Wetlands

Project Component	Waterbody or Wetland	Areal Extent of Potential Impact (square feet [sf]) /a	Anticipated Impacts based on Project Design
Landfall/ICW Work Area	Waterbody Great South Bay (mapped tidal wetland)	ICW HDD = 11,400	No impacts, installed via HDD
	Waterbody Atlantic Ocean (mapped tidal wetland)	Landfall HDD A = 23,700 Landfall HDD B = 25,950 Landfall HDD C = 30,400	No impacts, installed via HDD
	Estuarine Wetlands (W-01ASA, W-01ASB, W-01CFA)	0	No impacts, outside work area
	Palustrine Wetlands (W-01ASC, W-01CFB)	0	No impacts, outside work area
Temporary Floating Pier	Waterbody Great South Bay (mapped tidal wetland)	Pending ongoing design	Temporary tidal impacts will be minimized to the extent feasible
	Estuarine Wetland (W-01ASB)	Pending ongoing design	Temporary tidal impact for potential location near ICW Work Area on Fire Island will be minimized to the extent feasible
Onshore Transmission Cable—LIE Service Road Route	Watercourse S-01GP (Carmans River)	464	No impacts, installed via HDD
	Watercourse (S-10MA)	0	No impacts, outside work area
	Palustrine Wetlands (W-01GPA, W-01GPB, W-01GPC)	0	No impacts, outside work area
	Palustrine Wetlands and Waterbodies (WB-10MAA, WB-01GPA, W-10MAB, W-10MAC)	0	No impacts, outside work area
Union Avenue Site	None	0	None
Onshore Interconnection Cable	Pending access permissions for field surveys, none identified from desktop review	Pending ongoing field surveys	Pending access permissions for field surveys
/a The calculation for areal extent of potential impact represents the spatial overlap of wetlands and Project component work areas, not accounting for actual avoidance measures, and thus does not represent a calculation of actual anticipated direct impacts. Where there is overlap, Project components will be installed by HDD within work areas to avoid direct wetland impacts to the extent feasible.			

CONSTRUCTION AND OPERATIONS PLAN

Site Characterization and Assessment of Impacts – Biological Resources

At the Landfall Work Area, vegetation clearing and grading will be minimal as workspace will be largely limited to the developed areas (i.e., parking lot and surface roads). Use of HDD construction methods for transitioning the SRWEC to the Onshore Facilities will further avoid and minimize potential impacts to sensitive resources like Maritime Beach. The transition of the SRWEC into the Onshore Transmission Cable will be spliced together at co-located TJBs and link boxes located at Smith Point County Park on Fire Island in the Town of Brookhaven. If assembled on the beach, HDD conduit stringing activities would be located within the Smith Point County Park SCFWH. HDD conduit stringing would require laydown of linked conduit sections within coastal habitats prior to installation via HDD. HDD conduit stringing is anticipated to occur for 2 to 3 weeks per duct between October and March. HDD stringing work is not likely to result in adverse impacts to the Maritime Beach resource. The beach area where the HDD stringing is proposed consists of an unvegetated sand beach that is well-used by pedestrians and portions are open to vehicular traffic. Vegetated sand dunes are not expected to be affected by the HDD stringing activities. If this site is used, the minimal area required for construction will be employed to further minimize coastal habitat disturbance to natural communities potentially suitable for state and/or federally listed plant species, and Sunrise Wind will observe appropriate time-of-year restrictions for construction activities to the extent feasible. If work is anticipated to occur outside of these time-of-year restriction periods, Sunrise Wind will work with state and federal agencies to develop construction monitoring and impact minimization plans or mitigation plans, as appropriate. Effects of altered coastal habitat from Project activities on sea turtle, avian, and bat species are further described in Sections 4.4.5, 4.4.6, and 4.4.7, respectively.

As described in Section 3.3.10.2, some equipment and materials required for the Landfall HDD and ICW HDD may be transported via barge from the Smith Point Marina to Smith Point County Park due to existing weight limit restrictions on the Smith Point Bridge. A temporary floating pier may be installed at Smith Point County Park to aid in the offloading of equipment/materials. The temporary floating pier would be up to approximately 1,500 sq ft and would consist of a floating module and a ramp connecting the floating module to shore, as well as spuds for the pier and barge. The temporary floating pier would result in temporary minor tidal wetland impacts for the modules that may be grounded and for the spuds.

Along the Onshore Transmission Cable, including the ICW Work Area, potential land disturbance to coastal habitats will be avoided by using HDD methods. Use of HDD methods to cross the ICW also will avoid land disturbance to tidal wetlands. Once on the mainland, the Onshore Transmission Cable will be installed within existing roadway ROWs to minimize associated land disturbance or conversion of terrestrial habitats. At the Carmans River, use of HDD is anticipated to avoid land disturbance impacts to delineated wetlands and waterbodies. No SCFWH or NYNHP Significant Natural Communities are intersected by the Onshore Transmission Cable. Finally, potential spread of invasive plant species as a result of land disturbance from construction of Onshore Transmission Cable will be managed through implementation of an Invasive Species Management Plan (ISMP) that will be developed for the Project EM&CP.

At the Union Avenue Site, construction of the OnCS–DC will result in initial land disturbance of up to 7 acres (2.8 hectares) of forested terrestrial habitat converted to early successional grass/forb habitat or paved/gravel surfaces. Permanent terrestrial habitat impacts associated with the facility's footprint are expected to be up to 6 acres (2.4 hectares), depending on final design and site selection. No wetlands, SCFWH, or NYNHP Significant Natural Communities are

CONSTRUCTION AND OPERATIONS PLAN

Site Characterization and Assessment of Impacts – Biological Resources

associated with the Union Avenue Site. The spread of invasive plant species at the Union Avenue Site will be managed through the Project's ISMP.

The Onshore Interconnection Cable will be installed within existing roadway and utility-owned or controlled property. One NWI-mapped wetland, an unnamed freshwater pond (PABHx), is located adjacent to the Onshore Interconnection Cable but does not extend into the proposed corridor. No other wetlands, SCFWH, or NYNHP Significant Natural Communities were mapped along the potential routes for the Onshore Interconnection Cable.

Sediment Suspension and Deposition

Potential direct impacts to coastal and terrestrial habitat from sediment suspension and deposition during construction of the Onshore Facilities have been avoided and minimized to the maximum extent practicable through the use of HDD methods (or other trenchless methods) at the Landfall/ICW Study Area, ICW HDD, and along the Onshore Transmission Cable route. Use of HDD methods is expected to avoid direct impacts from sediment releases to SCFWH, NYNHP Significant Natural Communities, surface waters, and tidal and freshwater wetlands.

Where open trenching methods are used, construction activities will be limited to roadway and utility-owned or controlled property with use of appropriate erosion control measures. However, in the unlikely event that these measures do not work effectively, sediment suspension and deposition could occur within adjacent waterbodies or wetlands. These impacts would be temporary and properly mitigated, with water quality returning to pre-existing conditions quickly after the end of construction. Finally, the implementation of applicable permits (as described in Section 1.4) and environmental protection measures including the Project's SWPPP during earth disturbance will further minimize impacts from disturbed sediments for Onshore Facilities.

Discharges and Releases

Although no impacts from discharges and releases are anticipated, spills or accidental releases of fuels, lubricants, or hydraulic fluids could occur during use of trenchless installation and duct bank installation methods, installation of the Onshore Transmission Cable or Onshore Interconnection Cable, or during construction activities at the OnCS-DC. An SPCC Plan will be developed and any discharges or release will be governed by New York State regulations.

Additionally, where HDD is utilized, an Inadvertent Return Plan will be prepared and implemented to minimize the potential risks associated with release of drilling fluids.

Any unanticipated discharges or releases within the Onshore Facilities during construction are expected to result in minimal, temporary impacts; activities are heavily regulated, and discharges and releases are considered accidental events that are unlikely to occur.

Trash and Debris

Good housekeeping practices will be implemented to minimize trash and debris in onshore work areas. These practices will include orderly storage of tools, equipment, and materials, as well as proper waste collection, storage, and disposal to keep work areas clean and minimize potential environmental impacts. All trash and debris returned to shore from offshore vessels will be properly disposed of or recycled at licensed waste management and/or recycling facilities. Disposal of any solid waste or debris in the water will be prohibited. With proper waste management procedures, the potential for trash or debris to be inadvertently introduced onto an onshore area is unlikely.

CONSTRUCTION AND OPERATIONS PLAN

Site Characterization and Assessment of Impacts – Biological Resources

Operations and Maintenance

During routine O&M of the Onshore Facilities, infrastructure associated with the Onshore Transmission Cable and Onshore Interconnection Cable will be located underground and will have no impact on coastal and terrestrial habitats. Routine maintenance of the Onshore Transmission Cable will primarily involve observation and testing of existing equipment. Non-routine maintenance may cause limited land disturbance for temporary access to assess damage and for repair or replacement of infrastructure, but such occurrences are expected to be infrequent, localized, and short-term. O&M activities at the Union Avenue Site are not expected to impact coastal and terrestrial habitat. Effects from these O&M activities on benthic communities, avian species, and bat species are discussed in Sections 4.4.2, 4.4.6, and 4.4.7, respectively.

Seafloor and Land Disturbance

The routine O&M of the Onshore Transmission Cable and Onshore Interconnection Cable will have no impact on coastal and terrestrial habitats. As previously mentioned, limited land disturbance may occur for non-routine O&M of the Onshore Transmission Cable to repair or replace failed cable sections. These activities will be infrequent, localized, short-term, and largely limited to developed roadway and utility-owned or controlled property. Limited land disturbance may occur at the Union Avenue Site during O&M activities. However, because these activities will largely occur within areas previously disturbed for initial construction, O&M impacts to terrestrial habitat will be minimal.

Sediment Suspension and Deposition

During non-routine O&M of the Onshore Transmission Cable and Onshore Interconnection Cable, limited disturbance may occur to repair or replace cable sections if they become damaged or otherwise fail; however, these activities will largely occur within areas previously disturbed. Any work near wetland or waterbody crossings will be governed by several environmental permits including the SPDES General Permit for Stormwater Discharges associated with Construction Activities, which require the use of BMPs to minimize the opportunity for turbid discharges leaving a construction work area.

Discharges and Releases

The OnCS–DC will require various oils, fuels, and lubricants to support its operation, and SF₆ gas will also be used for electrical insulating purposes. As described above in the construction section, although no impacts from discharges and releases are anticipated, accidental discharges, releases, and disposal could occur; however, risks will be avoided through implementation of the measures described in the SPCC.

Trash and Debris

Solid waste and other debris will be generated predominantly during Project construction activities but may also occur during O&M of the Onshore Facilities. With the implementation of proper waste management procedures, and adherence to regulations, the potential for trash or debris to be inadvertently introduced onto an onshore area is unlikely.

CONSTRUCTION AND OPERATIONS PLAN

Site Characterization and Assessment of Impacts – Biological Resources

4.4.1.3 Proposed Environmental Protection Measures

Sunrise Wind will implement the following environmental protection measures to reduce potential impacts on coastal and terrestrial habitat. These measures are based on protocols and procedures successfully implemented for similar offshore projects.

- The SRWEC Landfall will be installed via HDD to avoid impacts to the nearshore zones and coastal resources. The Onshore Transmission Cable will also be installed via HDD under the ICW to avoid impacts to coastal resources; HDD and trenchless methods will also be used elsewhere onshore, where appropriate, to minimize impacts to resource areas. Onshore Facilities are primarily sited within previously disturbed and developed areas (e.g., roadways, ROWs, developed industrial/commercial areas) to the extent feasible, to minimize impacts to undisturbed coastal and terrestrial habitat.
- An SWPPP, including erosion and sedimentation control BMPs and revegetation measures, will be implemented to minimize potential water quality impacts from construction and O&M of the Onshore Facilities.
- Accidental spill or release of oils or other hazardous materials will be managed offshore through an ERP/OSRP and onshore through an SPCC Plan.
- Where HDD is utilized, an Inadvertent Return Plan will be prepared and implemented to minimize the potential risks associated with the release of drilling fluids.
- Time-of-year restrictions for certain work activities (e.g., HDD conduit stringing and tree removal) will be employed to the extent feasible to avoid or minimize direct impacts to terrestrial habitat and RTE species during construction of the Landfall and Onshore Facilities. If work is anticipated to occur outside of these time-of-year restriction periods, Sunrise Wind will work with state and federal agencies to develop construction monitoring and impact minimization plans or mitigation plans, as appropriate.
- Where appropriate, temporary erosion controls such as swales and erosion control socks will be installed and will be maintained until the site is restored and stabilized.
- An Invasive Species Management Plan (ISMP) will be implemented to manage the spread of invasive plant species that could negatively affect native plants and coastal habitat.
- Sunrise Wind will comply with applicable international (IMO MARPOL), federal (USCG), and state regulations and standards for treatment and disposal of solid and liquid wastes generated during all phases of the Project.

4.4.2 Benthic and Shellfish Resources

This section describes the affected environment and potential effects from the construction and operation of the marine components of the Project as they relate to benthic and shellfish resources. The description of the affected environment and assessment of potential impacts on benthic and shellfish resources were developed by conducting a Project-specific field survey and reviewing current public data sources related to benthic and shellfish resources, including state and federal agency-published papers and databases (e.g., LaFrance Bartley et al. 2018, NYSERDA 2017a, Poppe et al. 2014); online data portals and mapping databases (e.g., Northeast Ocean Data 2020, USGS 2020); environmental studies; published scientific

CONSTRUCTION AND OPERATIONS PLAN

Site Characterization and Assessment of Impacts – Biological Resources

literature relating to relevant benthic habitat distribution; and correspondence and consultation with federal and state agencies. Specific requirements for submittal of benthic and shellfish resources information within this COP are provided in BOEM's *Guidelines for Providing Benthic Habitat Survey Information for Renewable Energy Development on the Atlantic Outer Continental Shelf* (BOEM 2019) pursuant to 30 CFR Part 585 Subpart F. A description of the benthic and shellfish resources including a summary of the results from a site-specific benthic assessment survey in the SRWF and along the SRWEC is provided below, followed by an evaluation of potential Project-related impacts. More detailed information concerning the results of site-specific benthic assessment surveys and additional details on benthic resources in OCS and NYS waters are presented in Appendix M1– *Benthic Resources Characterization Report – Federal Waters* and Appendix M2 – *Benthic Resources Characterization Report – New York State Waters*, respectively. An additional supporting Technical Report, Appendix M3 – *Benthic Habitat Mapping Report* maps the habitats present across the marine portions of the Project Area, to inform EFH consultation. Habitat mapping integrates high resolution acoustic data from the site investigation surveys, the Sediment Profile and Plan View Imaging (SPI/PV) results, and results of the video survey that targeted possible complex bottom locations in the SRWF.

4.4.2.1 Affected Environment

Benthic habitats and the associated invertebrate communities serve important ecological functions in the Northwestern Atlantic. Hard bottom substrate as well as emergent taxa associated with soft bottom habitats can provide important refuge and/or spawning sites for fish and shellfish. In addition to providing structural habitat, benthic invertebrates function as trophic links to higher-order consumers, including commercially valuable species. Benthic communities also contribute to other important ecosystem functions including influencing water quality and facilitating nutrient and carbon cycling.

Regional Setting

The Lease Area is located offshore on the Northwestern Atlantic OCS within the Mid-Atlantic Bight; a portion is within the southern part of the RI and MA WEA and the remainder is located within the western portion of the MA WEA. The SRWEC is planned to extend westward from the southern part of the lease through New York Bight to Fire Island, NY. The waters in the vicinity of the SRWF and SRWEC are transitional waters positioned between the continental slope and the coastal environments of Long Island Sound and Narragansett Bay. As described in more detail below, the region is generally characterized by predominantly mobile sandy substrate, and the associated benthic communities are adapted to survive in a dynamic environment.

Benthic community assemblages and their associated ecological functions vary spatially and temporally across the Northwest Atlantic OCS and across the marine portions of the Project Area. The physical attributes of the benthic environment, including sediment composition, hydrodynamics, and light availability, in addition to biological factors such as predation and competition, determine the species composition of benthic communities.

CONSTRUCTION AND OPERATIONS PLAN

Site Characterization and Assessment of Impacts – Biological Resources

The benthic habitat types observed during the site-specific benthic assessment survey are summarized and discussed here in concert with previously collected data on surface sediments, biota, and habitat types found and likely to be found across the offshore WEAs (Stokesbury 2012, 2014; Bay State Wind 2019; Deepwater Wind South Fork, LLC 2019; NYSERDA 2017b; DWW Rev I, LLC 2020) (Figure 4.4.2-1). The species that inhabit the benthic habitats of the OCS are typically described as infaunal species, those living in the sediments (e.g., polychaetes, amphipods, mollusks), and epifaunal species, those living on the seafloor surface (mobile, e.g., sea stars, sand dollars, sandshrimp) or attached to substrates (sessile, e.g., barnacles, anemones, tunicates). Lists of species commonly associated with the benthic habitats and the depth ranges found at the SRWF and along the SRWEC–OCS and SRWEC–NYS are provided in Appendix M1 (Tables 5.2-1 (flora), Table 5.2-2 (fauna), and Table 5.2-3 (ecological and economically important shellfish)).

Existing benthic data collected within the vicinity of and overlapping with the SRWF and SRWEC span several recent years and seasons (Bay State Wind 2016; Bay State Wind 2019; Guida et al. 2017; Stokesbury 2012 and 2013; NYSERDA 2017; South Fork Wind 2019; Revolution Wind 2019). Generally, in the absence of physical disturbance or organic enrichment, benthic habitats in the northwest Atlantic outer continental shelf are stable with little seasonality (Steimle 1982; Reid et al. 1991; Theroux and Wigley 1998; HDR 2020). Seasonal trends in benthic macrofaunal abundances have been documented on the continental shelf off the East Coast of the US (as reviewed in Brooks et al. 2006). Several studies reported late spring or early summer as times of peak biomass (Cutler and Diaz 1998; Turbeville and Marsh, 1982); other studies found highest macrofaunal densities in the fall (Boesch et al. 1977, Maurer et al. 1976), while still other studies reported no difference in macrofaunal biomass by season (Maurer and Leathem 1981). Although there are likely shifts in benthic community assemblages and particular taxa abundances from year-to-year and seasonally, the benthic habitat and ecological functioning of the benthic community is generally stable in the marine portions of the Project Area. Specific sensitive taxa in the region, including soft corals, are generally long-lived and sessile. As such, their distributions and presence is not strongly influenced by seasonality.

Figure 4.4.2-1
Recent Studies of
Benthic Biology and/or Geology

Sunrise Wind | Powered by Ørsted & Eversource

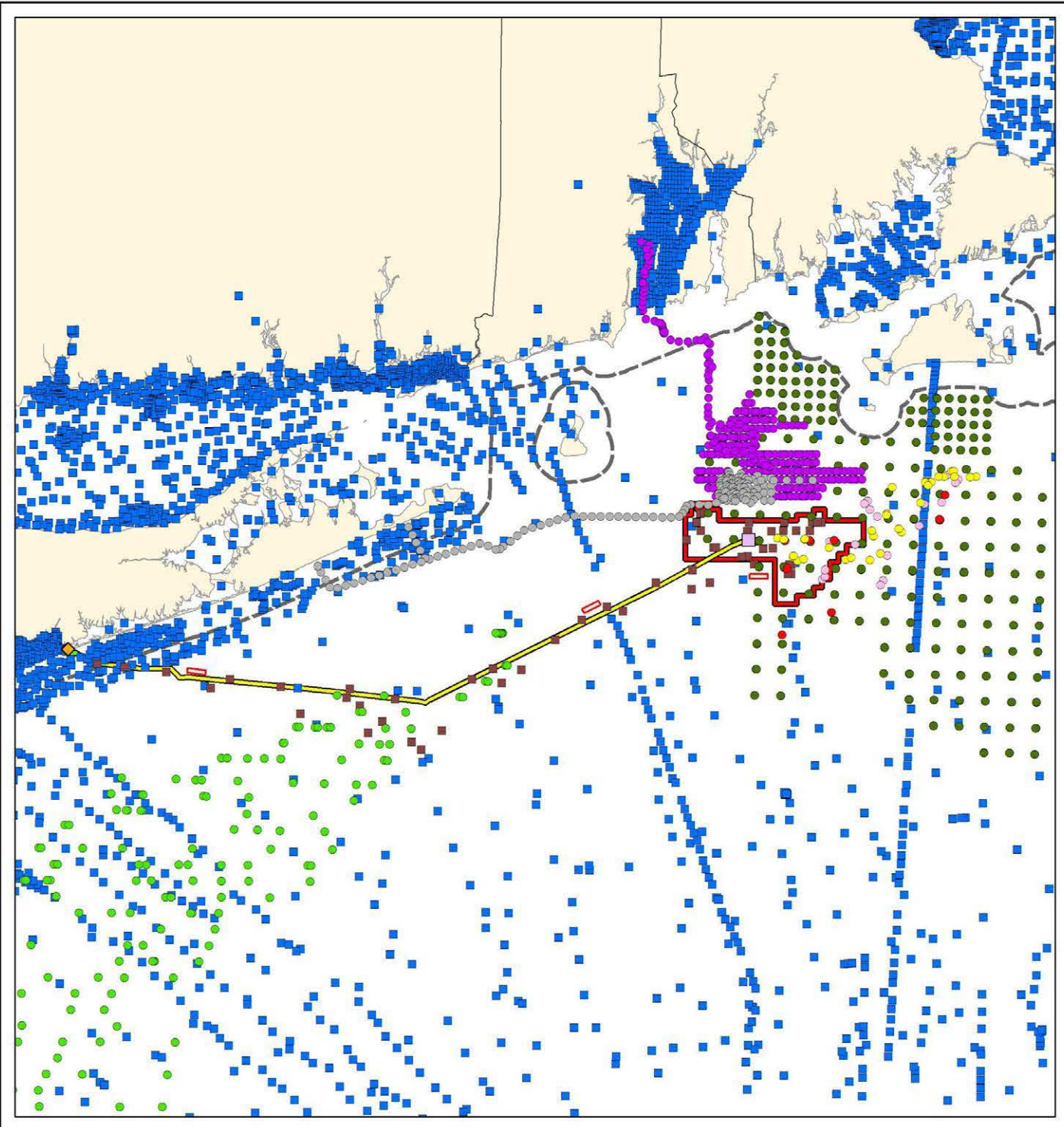

Legend

- Sunrise Wind Farm (SRWF)
- Offshore Converter Station (OCS-DC)
- ◆ SRWEC Landfall Location
- Sunrise Wind Export Cable (SRWEC-NYS)
- Sunrise Wind Export Cable (SRWEC-OCS)
- 3 Nautical Mile State Water Boundary
- Reference Area

Biological/Geophysical Data

- Bay State Wind 2019
- INSPIRE South Fork Wind 2019
- INSPIRE Revolution Wind 2019
- INSPIRE NYSERDA 2017
- Guida 2017
- Bay State Wind 2016
- Stokesbury 2012 & 2013

Geophysical Data

- Fugro 2020
- USGS usSEABED 2019

Date	11/30/2020
Project Number	
Prepared By	
Reviewed By	

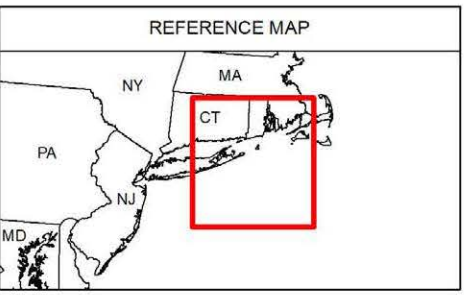
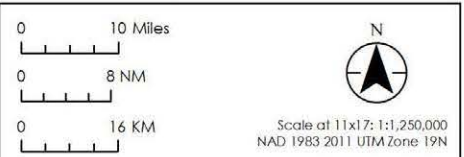

This page intentionally left blank

CONSTRUCTION AND OPERATIONS PLAN

Site Characterization and Assessment of Impacts – Biological Resources

Benthic invertebrate assemblages in the Northwest Atlantic OCS provide important ecosystem functions. Benthic communities serve as critical trophic links between plankton and higher-order consumers, including some managed species. Benthic organisms, particularly attached epifauna and emergent infauna, may also add complexity to the seafloor, providing structural biogenic habitat for other species. For example, in soft sediment environments with low physical complexity, emergent infauna, such as burrowing anemones (cerianthids), tube-building polychaetes, and tube-building amphipods, provide biogenic structure to the environment, creating a unique habitat in an otherwise structurally void environment. In addition to trophic links and biogenic structure, benthic species can also serve important roles in facilitating nutrient and carbon cycling in the sediments through functions such as water filtration, biodeposition, bioirrigation, and bioturbation.

Benthic community assemblages and their associated ecological functions vary spatially across the Northwest Atlantic OCS and, specifically, the marine portions of the Project Area. Sediment grain size distribution is an important factor of benthic habitats and influences benthic community distributions and can be used to infer benthic taxa that are likely present in a particular environment. Linking the physical substrate characteristics with the biological functional and taxonomic composition is accomplished using the Coastal and Marine Ecological Classification Standard (CMECS) (Federal Geographic Data Committee 2012), as recommended by BOEM (BOEM 2019). CMECS provides a standard means to categorize the physical (substrate) and biological (biotic) components of environments. CMECS definitions and utility are provided in more detail in Appendices M1 and M2.

The WEAs are composed of a mix of soft and hard bottom environments as defined by the dominant sediment grain size and composition (Continental Margin Mapping Program [Department of the Interior 2020]; usSEABED [USGS 2020]). The benthic environment of the RI-MA and MA WEA's is dominated by sandy sediments that ranged from very fine to medium sand; very fine sands tend to be more prevalent in deeper, lower energy areas (i.e., the southern portion of the MA WEA), whereas coarser sediments, including gravels (e.g., patchy cobbles and boulders) were found in shallower areas (i.e., the central region of the RI and MA WEA) (Bay State Wind 2019, Deepwater Wind South Fork, LLC 2019; DWW Rev I, LLC 2020; Stokesbury 2014; LaFrance et al. 2010; McMaster 1960; Poppe et al. 2014). This range of grain sizes is typical of OCS glacial moraine depositional environments that include Holocene marine transgressive deposits (O'Hara and Oldale 1980).

Benthic community structure within this region has been assessed by several studies including benthic characterization surveys associated with the development of nearby wind leases including Bay State Wind (Bay State Wind 2019), Revolution Wind (DWW Rev I, LLC 2020), South Fork Wind Farm (Deepwater Wind South Fork, LLC 2019), in addition to other regional benthic assessments (Guida et al. 2017, Greene et al. 2010, Stokesbury 2012, 2014, NYSERDA 2017b) (Figure 4.4.2-1). Most relevant to the RI-MA WEA are the CMECS Biotic Subclasses Attached Fauna and Soft Sediment Fauna, which are broad-scale categories for these seafloor habitats (Appendices M1 and M2).

CONSTRUCTION AND OPERATIONS PLAN

Site Characterization and Assessment of Impacts – Biological Resources

In the Northwest Atlantic OCS, the Soft Sediment Fauna Subclass typically includes deep-burrowing polychaetes, tube-building amphipods and polychaetes, as well as epifaunal species including sand shrimp, sand dollars, and sea stars (Guida et al. 2017; Stokesbury 2012, 2014; Deepwater Wind South Fork, LLC 2019; DWW Rev I, LLC 2020). Guida et al. (2017) observed infaunal communities associated with sand or finer substrates within both the RI-MA WEA and the MA WEA were generally numerically co-dominated by amphipods and polychaetes, while sand shrimp and sand dollars were the most prevalent epifauna. Soft bottom habitats, including those documented during the site-specific benthic surveys (e.g., sand and mud, sand with ripples, and sand with mobile gravel) are suitable for the following ecologically and economically important shellfish species: Atlantic sea scallop (*Placopecten magellanicus*), Jonah crab (*Cancer borealis*), Atlantic rock crab (*Cancer irroratus*), channeled whelk (*Busycotypus canaliculatus*), ocean quahog clam (*Arctica islandica*), Atlantic surf clam (*Spisula solidissima*), and horseshoe crab (*Limulus polyphemus*). Additionally, longfin squid (*Doryteuthis (Amerigo) pealeii*) may utilize sand with mobile gravel habitats. Appendix M1 includes a summary of these species, likelihood of presence, and the potential time-of-year that they could be present in the region (Table 5.2-3 in Appendix M1).

Commercially harvested bivalves including sea scallops, ocean quahogs, and surf clams inhabit soft bottom habitats in the Northwest Atlantic OCS. Ocean quahogs are known to be distributed across the planned SRWEC–OCS and the SRWF, with their EFH overlapping with portions of the SRWF (NOAA Fisheries 2020a) and were reported within the SRWF during the Bay State Wind benthic assessments (Bay State Wind 2019). EFH for sea scallop overlaps with the planned SRWEC corridor as well as the western portion of the SRWF (NOAA Fisheries 2020b). Atlantic sea scallops occur along the continental shelf, typically at depths ranging from 59 to 360 ft (18 to 110 m) and are generally found in seabed areas with coarse substrates consisting of firm sand, gravel, shells, and rocks (Hart and Chute 2004). EFH for Atlantic surf clam occurs around the nearshore portions of the SRWEC corridor. Surf clams prefer sandy habitats along the continental shelf (Cargnelli et al. 1999), and are most abundant on Georges Bank, the south shore of Long Island, and along the coasts of New Jersey and the Delmarva Peninsula (NOAA Fisheries 2020c). Surf clams generally occur from the beach zone to a depth of about 200 ft (61 m), but abundance is low beyond about 125 ft (38 m). Surf clams can be found up to 3 ft (1 m) below the sediment water interface. The most recent data collected during the Atlantic Surfclam and Ocean Quahog Survey by the Northeast Fisheries Science Center (NEFSC) was in 2018; this shows that densities of ocean quahogs and Atlantic surf clams range from 0 to 0.375 per m² and 0 to 1.25 m², respectively, as shown in the sampling extent of Figure 4.4.2-2 (NEFSC 2021). EFH for sea scallop overlaps with the planned SRWEC corridor as well as the western portion of the SRWF (NOAA Fisheries 2020b). Atlantic sea scallops occur along the continental shelf, typically at depths ranging from 59 to 360 ft (18 to 110 m) and are generally found in seabed areas with coarse substrates consisting of firm sand, gravel, shells, and rocks (Hart and Chute 2004). More detailed information on the distribution of these commercially fished bivalve species is provided in Appendix N, which describes the EFH associated with the Project.

V:\1956\active\Task Owner and other Non-BC1956\Jobs\2028113199\03_data\gis_cad\gis\KDE\COP\2028113199_4.4.2-2_BivalveDensity.mxd Revised: 2021-05-28 By: gearpennter

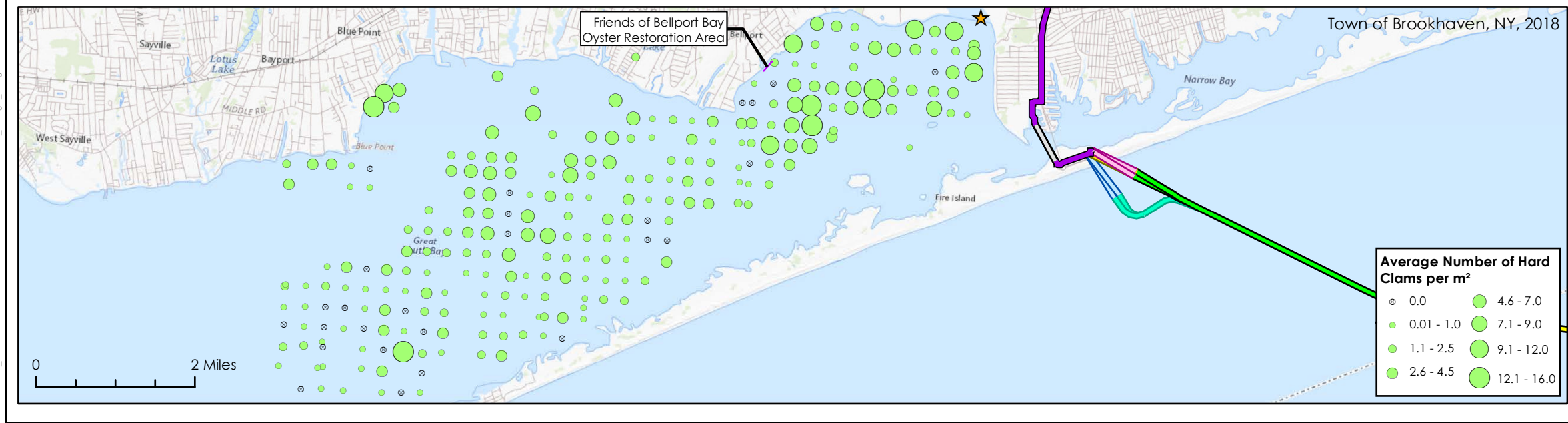
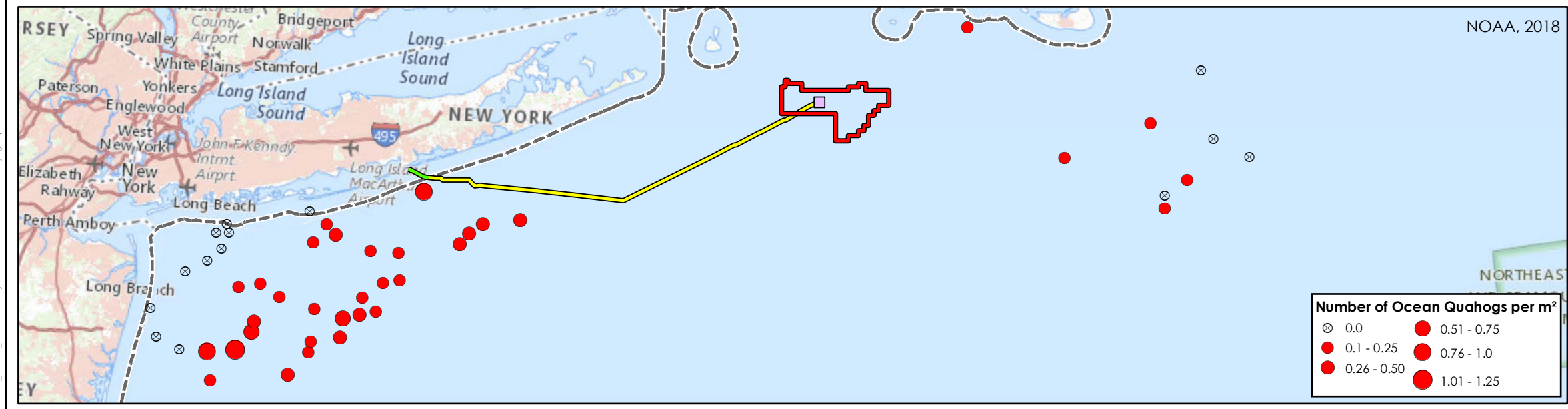
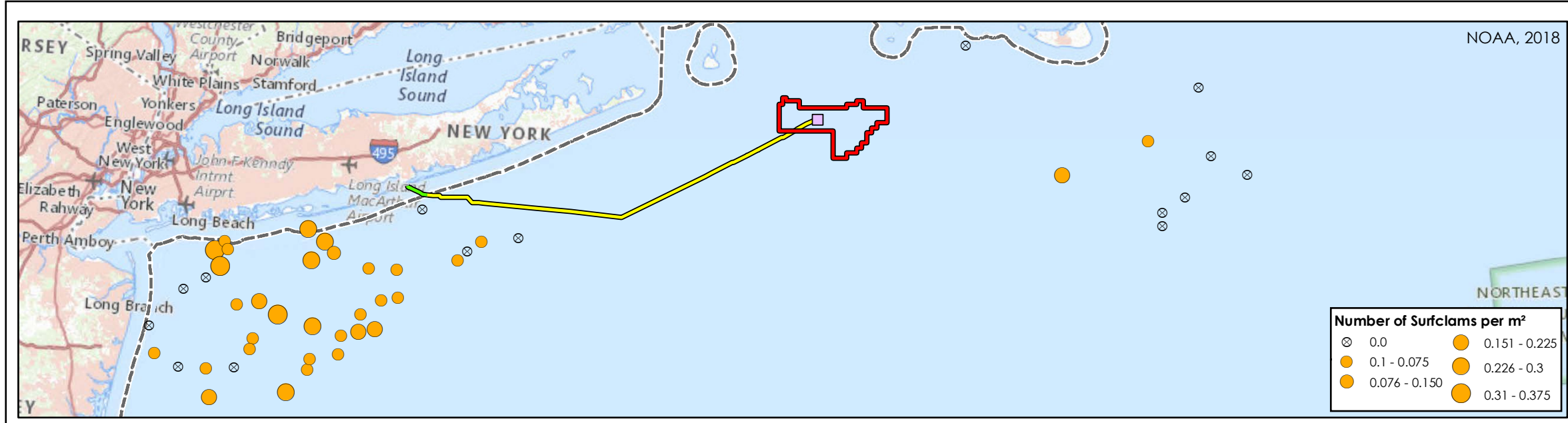

**Figure 4.4.2-2
Bivalve Densities –
SRWEC–NYS and ICW**

Sunrise Wind | Powered by **Ørsted & Eversource**

Legend

- Sunrise Wind Farm (SRWF)
- Sunrise Wind Export Cable (SRWEC–OCS)
- Sunrise Wind Export Cable (SRWEC–NYS)
- SRWEC–NYS (Western Landfall Option)
- Landfall HDD A
- Landfall HDD B
- Landfall HDD C
- Intracoastal Waterway HDD (ICW HDD)
- Onshore Transmission Cable–LIE Service Road Route
- 3-nm State Waters Boundary
- Offshore Converter Station (OCS–DC)
- ★ Long Island Shellfish Restoration Initiative Hard Clam Sanctuary
- Friends of Bellport Bay Oyster Restoration

Note
Routes are indicative and subject to engineering design changes.

Sources
1. Town of Brookhaven, NY (2018), NOAA (2018)
2. Base map: USGS The National Map

Date	6/1/2021
Project Number	2028113199
Prepared By	HT
Reviewed By	LJ

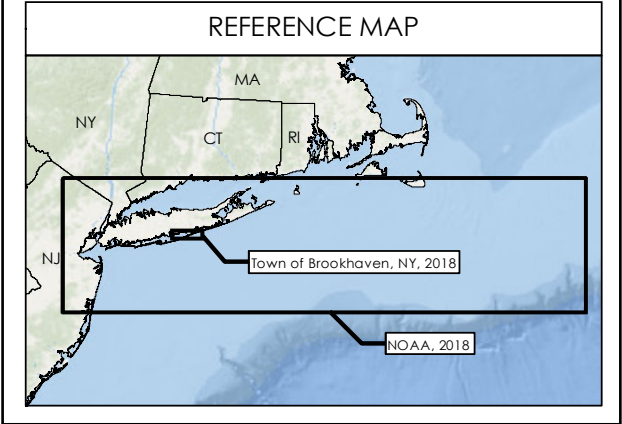
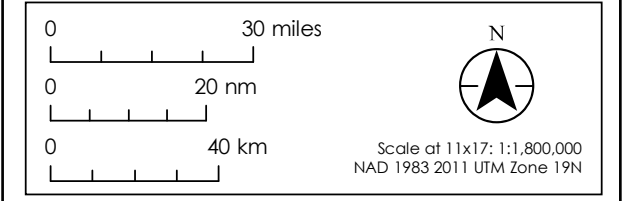

This page intentionally left blank

CONSTRUCTION AND OPERATIONS PLAN

Site Characterization and Assessment of Impacts – Biological Resources

Hard bottom habitats, often characterized by the CMECS Biotic Subclass Attached Fauna, are limited in regional distribution in the Northwest Atlantic OCS compared to sandy and soft bottom habitats (CoastalVision and Germano and Associates 2010; Greene et al. 2010; Poppe et al. 2014). Hard bottom habitats are commonly referred to as “live bottom” when encrusted by attached epifauna (e.g., bryozoa, hydroids, tunicates, and sponges). These structurally complex habitats are considered to be potentially valuable and sensitive for regionally important taxa including targeted species, such as Atlantic cod (*Gadus morhua*), longfin squid, and American lobster (*Homarus americanus*). The structure provided by the cobbles and boulders in these habitats can serve as nursery habitat for juvenile lobster, feeding ground for fish such as cod and black sea bass, and substrate upon which squid (including longfin squid) lay their eggs (Griswold and Prezioso 1981; Roper et al. 1984). Furthermore, the presence of boulders in mixed bottom types has been noted as an important feature for understanding the distribution of lobster and Jonah crab in this region (Collie and King 2016). Both lobster and squid have highly specific habitat requirements and are also economically important species in New England. For these reasons, federal and state agencies consider evidence of these taxa to indicate the presence of potentially sensitive habitats (BOEM 2019). Notably, the lobster industry in Southern New England and New York are transitioning to targeting Jonah crabs, which may also seek refuge in hard bottom habitats, but are also known to occupy soft bottom habitats (Truesdale et al. 2019).

In addition to valuable hard bottom habitats, other potentially sensitive benthic habitats include areas where corals are present or in habitats with submerged aquatic vegetation (SAV) beds (BOEM 2019). Legally protected species of reef-building corals are not found in the RI-MA WEA or MA WEA (Guida et al. 2017). However, the northern star coral, a non reef-building taxon, was observed at the Revolution Wind Farm, South Fork Wind Farm, and SRWF, although in limited spatial distribution (Deepwater Wind South Fork, LLC 2019; DWW Rev I, LLC 2020; Appendix M1). Due to sunlight requirements, SAV beds are limited to shallower depths and, thus, do not occur within the RI-MA WEA or MA WEA. However, SAV beds, including both eel grass (*Zostera marina*) and Widgeon grass (*Ruppia maritima*), are found in the shallow bays north of Fire Island, New York (LaFrance Bartley et al. 2018; NYSDEC 2019; NYSDOS, GOSR, NOAA, Dewberry 2020), under which the Onshore Transmission Cable will be installed via the ICW HDD between Fire Island and the mainland. There have been recent efforts to restore eelgrass beds within Bellport Bay, with mixed results. Specifically, the Town of Brookhaven in partnership with Cornell Cooperative Extension Marine Program, has completed several eel grass restoration projects within Bellport and Moriches Bay (one on a shoal north of Bellport Bay Channel, another northeast of the John Boyle Island, and a third west of Swan Island in Moriches Bay) (Trihamletnews 2020). In 2019, monitoring results at a restoration site within the Fire Island National Seashore found no eelgrass surviving from the initial plantings, which may be due to stressors including high boat traffic, sediment transport, and/or high density of blue mussels set on the eelgrass (NPS 2020). A site-specific video survey was conducted to document the presence of SAV in the vicinity of the ICW HDD route, results are summarized below.

CONSTRUCTION AND OPERATIONS PLAN

Site Characterization and Assessment of Impacts – Biological Resources

Regional Effects of Climate Change on Benthic Resources

In the vicinity of SRWF and, in general, along the US Northeast OCS and continental slope, benthic communities have experienced increased water temperatures over the past several decades (Kavanaugh et al. 2017). Numerous benthic and pelagic species are predicted to shift their ranges northward and into deeper waters in response to increasing water temperatures (Kleisner et al. 2017; Selden et al. 2018). Modeling predicts that bottom temperatures in southern New England will become too warm to support larval development of the commercially valuable American lobster, causing this species to move offshore and northward (Rheuban et al. 2017). In southern New England, lobster catches have declined in recent decades, which may be attributable to increased water temperatures and associated increases in shell disease prevalence (Wahle et al. 2015; Collie and King 2016; Groner et al. 2018; Jaini et al. 2018). Cascading socioeconomic effects on the industries that harvest these species are anticipated although it can be difficult to accurately predict which fisheries may be affected; some fishermen may benefit from the presence of new target species. For example, black seabass and spiny dogfish are predicted to increase in the vicinity of the SRWF as sea temperatures continue to increase (Selden et al. 2018). Additionally, the lobster fishery in southern New England has transitioned to harvesting Jonah Crabs as a way to supplement income (Truesdale et al. 2019).

As temperatures increase over time, the average pH is expected to continue to decline as seawater becomes more saturated with carbon dioxide (Saba et al. 2016). Acidification of seawater is associated with decreased survival and health of organisms with calcareous shells (such as the Atlantic scallop, blue crab, and hard clam). Larvae that survive to the recruitment stage may have thinner or deformed shells and be more susceptible to predators (Stevens and Gobler 2018). Modeled scenarios of decreasing seawater pH predict a substantial decline in the harvestable stock of the Atlantic scallop, with collateral loss of economic value (Rheuban et al. 2018).

Site-specific Benthic Assessment

To better understand the site-specific benthic characteristics of the SRWF and the SRWEC, initially a geophysical survey was conducted in 2019, with grab samples collected for grain size analysis (Appendix G1). Site-specific benthic habitat assessments were conducted in the spring (SRWF and SRWEC–OCS) and summer (SRWEC–NYS) of 2020, using a combined SPI/PV system. The data generated from these SPI/PV surveys met BOEM *Benthic Habitat Survey Guidelines* (BOEM 2019) to characterize surface sediments; delineate and characterize hard bottom areas; identify and confirm benthic flora and fauna, including sessile and slow-moving invertebrates; identify sensitive habitats; establish pre-construction baseline benthic conditions against which post-construction habitats can be compared; and determine the suitability of sampled reference areas to serve as controls for future monitoring and assessment. In addition to the SPI/PV surveys, a nearshore drop-video survey in combination with SPI/PV sampling was conducted in the summer of 2020 to assess the benthic environment and specifically to verify the presence of SAV beds in the ICW, north of Fire Island between Bellport Bay and Narrow Bay, as informed by spatial seagrass data provided by NYSDOS (2020). Data from the summer SRWEC–NYS survey and the ICW survey are provided in Appendix M2.

CONSTRUCTION AND OPERATIONS PLAN

Site Characterization and Assessment of Impacts – Biological Resources

Also, in the summer of 2020, a video survey was conducted at the SRWF to further delineate complex bottom observed during geophysical surveys and the offshore SPI/PV survey, and to inform habitat mapping (Appendix M3).

A summary of the SPI/PV surveys data is provided below, and more details are provided in the benthic characterization technical reports (Appendices M1 and M2). Results from the comprehensive SPI and PV image analysis are included for the SRWF and SRWEC–OCS in Appendix M1 and are included for the SRWEC–NYS and ICW HDD in Appendix M2. The habitat types observed during the site-specific SPI/PV survey are discussed here in concert with previously collected data on surface sediments, biota, and habitat types found and likely to be found in the region. Benthic habitat types are used here as a construct to describe repeatable physical/-biological associations and were derived from CMECS classifiers and modifiers obtained from the SPI/PV analyses; the specific CMECS Substrate and Biotic Component classifications are provided in Appendices M1 and M2. Given the spatial scale of the SPI/PV point data, benthic habitat types derived from replicate SPI/PV images are considered macrohabitats (*sensu* Greene et al. 2007). The benthic habitat types are further refined at a broader scale by integrating SPI and PV image analysis with high-resolution geophysical data in Appendix M3.

During the site-specific SPI/PV survey in federal waters, 20 stations were surveyed within four potential reference areas. These reference areas were selected to capture habitats representative of those at the SRWF and along the SRWEC. One reference area was located north of the northwest region of the SRWF, another was located south of the SRWF near the beginning of the SRWEC. Two reference areas were situated close to the SRWEC route: one north of the eastern portion of the SRWEC–OCS and the other north of the western portion of the SRWEC–OCS. In general, the reference areas' physical and biological features were similar to the nearby Project SPI/PV stations as discussed further in Appendix M1.

Sunrise Wind Farm

Seven benthic macrohabitat types were documented during the site-specific SPI/PV survey at the SRWF as characterized based on the comprehensive SPI and PV analyses of select physical and biological attributes: (1) *sand and mud*, (2) *sand and mud with ripples*, (3) *sand*, (4) *sand with ripples*, (5) *sand with mobile gravel*, (6) *patchy cobbles and boulders on sand*, and (7) *cobbles and boulders on sand* (Table 4.4.2-1). The species found in these types of benthic habitats are typically described as infaunal species, those living in the sediments (e.g., polychaetes, amphipods, mollusks), and epifaunal species, those living on the seafloor surface (mobile, e.g., sea stars, sand dollars, sand shrimp) or attached to substrates (sessile, e.g., barnacles, anemones, tunicates).

The distribution of these seven macrohabitat types is described in detail in Appendix M1 and mapped in Figure 4.4.2-3. These benthic macrohabitat types vary spatially across the region, differing in sediment composition as well as benthic community assemblages and resources, as discussed further below. The frequency and magnitude of hydrodynamic forcing on the seabed also varied across these macrohabitat types with *sand and mud with ripples*, *sand with ripples*, and *sand with mobile gravel* having attributes indicative of a mobile and relatively high energy environment (e.g., sand ripples and washed gravel).

CONSTRUCTION AND OPERATIONS PLAN

Site Characterization and Assessment of Impacts – Biological Resources

While *sand and mud* without ripples (or indistinct ripples) is presumed to have lower hydrodynamic energy, creating a more stable benthic environment, suggested by the lack of small-scale bedforms (e.g., ripples). The hydrodynamic energy associated with macrohabitats with small and large gravels with attached epifaunal growth is less clear. The growth (e.g., Tubularia hydroids) on small gravels (i.e., pebbles/granules) may suggest lower energy as these small gravels are stable enough for organisms to grow (movement of the gravel or sand will abrade the organisms). While larger gravels (i.e., cobbles and boulders) with extensive growth of encrusting organisms (e.g., bryozoa, hydroids, northern star coral) are more likely to suggest a high energy setting, with the size of the gravels preventing the physical movement of these substrata.

Mud and sand, with and without small-scale bedforms (i.e., ripples), was the primary benthic macrohabitat observed across the surveyed area during the site-specific SPI/PV survey. This is corroborated by other studies in the eastern part of the region (Stokesbury 2012, 2014; Bay State Wind 2019). In general, the deeper regions of the surveyed area (e.g., the southeast and west-central regions of the SRWF, and the eastern portion of the SRWEC–OCS) appeared to be lower energy, indicated by a lack of rippling on the seabed and fine grain sizes (primarily CMECS Substrate Subgroup of Very Fine Sand) (Figures 3.1-2, 3.1-9, 3.1-5 in Appendix M1). At SRWF, *mud and sand* macrohabitat was characterized by tube-building infauna, burrowing infauna (including burrowing anemone, cerianthids), and mobile epifauna (including sea stars) (Table 4.4.2-1). Tracks, burrows, and tubes are commonly associated with this macrohabitat. The other soft bottom habitats that were frequently observed at the SRWF was *sand with ripples* and *sand and mud with ripples* (Figure 4.4.2-3). These macrohabitats were typically associated with more mobile sediments, as implied by the presence of regular and irregular small and large sand ripples (e.g., the northeast region of the SRWF). These higher energy habitats are typically inhabited by tube-building infauna, filter-feeding bivalves, and sand dollars (Table 4.4.2-1). The dynamic nature of these environments results in high turnover of infauna, and, combined with the low organic loads found particularly in medium and coarse sands, typically results in low prevalence of head-down deposit feeding infauna and higher abundances of suspension feeders (e.g., sand dollars and bivalves).

Sand with mobile gravel, *patchy cobbles and boulders on sand*, and *cobbles and boulders on sand* were three macrohabitat types that were generally more complex than the soft bottom habitats and were mainly observed in the northwest corner and north-central border of the SRWF. In these areas, SPI/PV stations were classified with CMECS Substrate Groups/Subgroups with greater than 5 percent gravel cover (Appendix M1). *Sand with mobile gravel* was characterized by clusters of generally small-sized gravels (granules, pebbles, and small cobbles) (Figure 4.4.2-4) that are influenced by bottom currents (tides, storms) and are transported often enough, appearing “washed clean.” Due to the frequent disturbance from hydrodynamic forces, biota here are not able to attach and grow on the gravel surfaces in this habitat. The habitats *sand* and *sand with mobile gravel* both experience frequent hydrodynamic forcing and subsequent sediment mobility that creates a dynamic environment for biota. Therefore, these habitats do not commonly include attached flora or sessile attached epifauna. Instead, these habitats are inhabited by mobile epifauna, such as sea stars, Jonah crabs, American lobster, and small tube-building and burrowing infauna (Table 4.4.2-1).

CONSTRUCTION AND OPERATIONS PLAN

Site Characterization and Assessment of Impacts – Biological Resources

However, there is still potential, specifically in the *sand with mobile gravel* habitats, that hydrozoans, attached anemones, and encrusting sponges will be present in low densities, particularly when in close proximity to boulders and cobbles.

Patchy cobble and boulders on sand and *cobbles and boulders on sand* macrohabitat types were observed primarily in the northwest region of the SRWF (Figure 4.4.2-3). Benthic habitat assessments at Revolution Wind (particularly the southwest region of the Revolution Wind lease area) and South Fork Wind both reported similar heterogeneous habitat types composed of generally coarse substrata, which were associated with Pleistocene Moraine Deposits (O'Hara and Oldale 1980; Deepwater Wind South Fork, LLC 2019; DWW Rev I, LLC 2020). Given the close proximity of the northwest region of SRWF to these previously studied areas, the origin of this patchy cobble and boulders is likely similar.

The restriction of this habitat to the northwestern edge would suggest the extreme southern extent of glacial moraine in this part of Rhode Island Sound (O'Hara and Oldale 1980). The large gravel associated with these macrohabitat types, generally supports increasingly diverse epifaunal assemblages as grain sizes increase and the gravels become more physically stable. Cobbles and boulders provide substrata and stability for biota to attach and grow; additionally, these macrohabitats provide variable topography that creates complexity and additional niches for fauna to occupy. Where present, these large gravels were often colonized by attached epifauna, predominantly anemones, encrusting sponges, bryozoa, hydroids, and non-reef-building hard corals, as well as diverse mobile epifauna such as hermit crabs, sea stars, and gastropods. Because the presence of cobbles and boulders is often patchy, these areas are interspersed with sand, further increasing niche space and diversity within these areas. Where coarser gravel (i.e., cobbles and boulders) on sandy substrates were documented at the SRWF, epifaunal organisms were typically found growing on the physical substrate, including hydroids, bryozoa, barnacles, and occasional anemones. There was not a high occurrence of boulders across the surveyed area. Boulders were only observed at 12 SPI/PV stations within the SRWF, 11 of which were located in the northwest corner while the remaining station was along the southern border of the SRWF at approximate longitude of 71.1°W (Figure 4.4.2-3).

The northern star coral, *Astrangia poculata*, a non reef-building hard coral, was the only sensitive taxa observed across the surveyed area, occurring only at five SPI/PV stations at the SRWF (Stations 003, 085, 227, 702, and 721) (Appendix M1). The sea scallop, a species of concern in the region, was found at 13 SPI/PV stations interspersed across the SRWF (Appendix M1). An Ocean quahog (*Arctica islandica*), another species of concern in the region, was observed at one SPI/PV station, located in the southeast portion of the SRWF, while dead clam shell valves were observed on the sediment surface at several stations (Figures 2.2-15, 2.2-16, 2.2-17 in Appendix M1). Additionally, the Jonah Crab, a notable species given its increasing importance as a targeted species by the fishing industry, was observed at two SPI/PV stations within the SRWF (Stations 091 and 121), both of which were characterized by the *sand and mud* macrohabitat type (Appendix M1).

This page intentionally left blank

**Figure 4.4.2-3
Macrohabitat (SPI/PV)**

Sunrise Wind | Powered by Ørsted & Eversource

Legend

- Sunrise Wind Farm (SRWF)
- Offshore Converter Station (OCS-DC)
- Sunrise Wind Export Cable (SRWEC-OCS)
- 3 Nautical Mile State Water Boundary
- Reference Area

Macrohabitat (SPI/PV)

- Cobbles and boulders on sand
- Patchy cobbles and boulders on sand
- Sand with mobile gravel
- Sand with ripples
- Sand and mud with ripples
- Sand
- Sand and mud
- Indeterminate

Sources

- Base map: USGS The National Map

Date	11/30/2020
Project Number	
Prepared By	
Reviewed By	

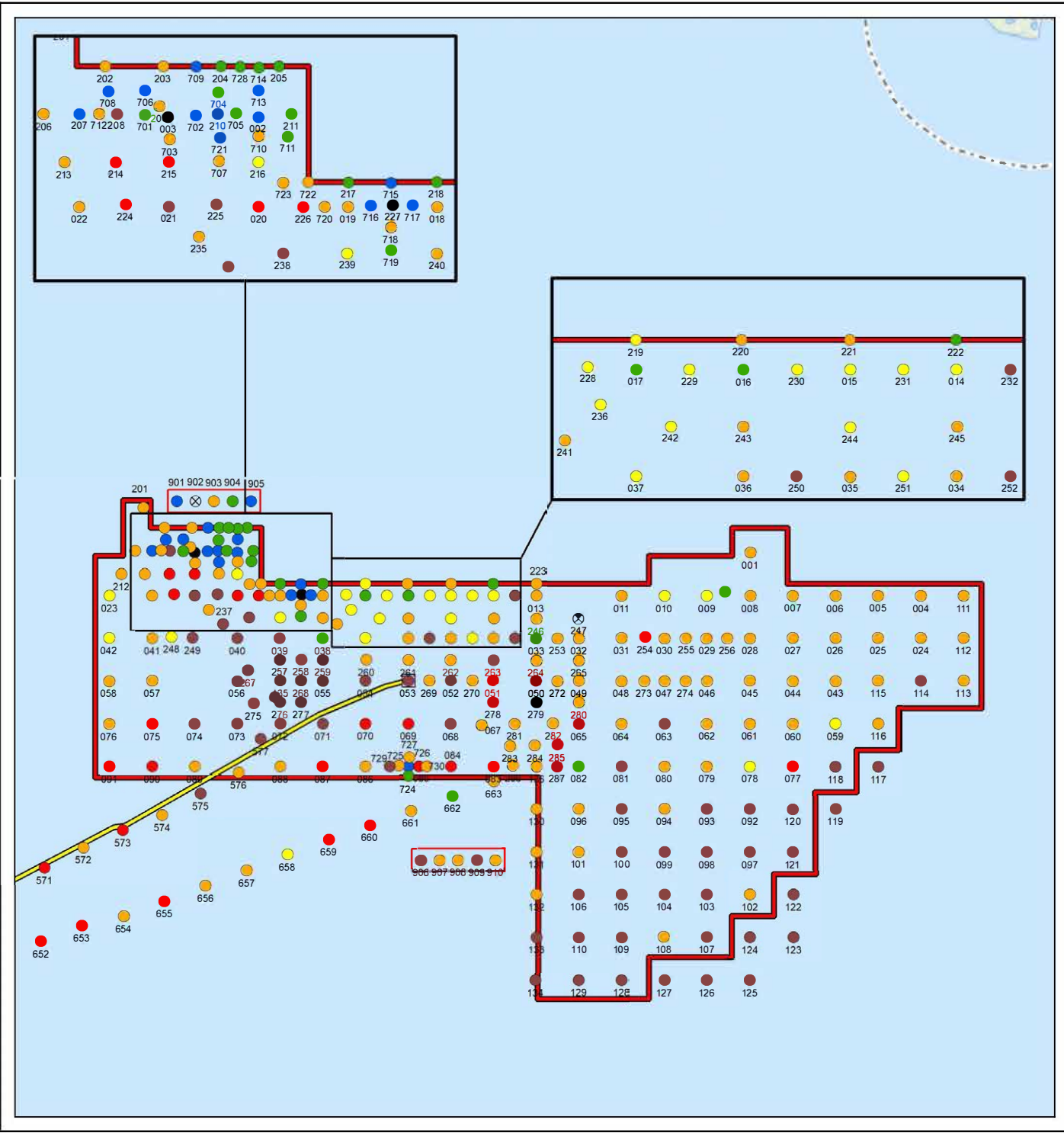
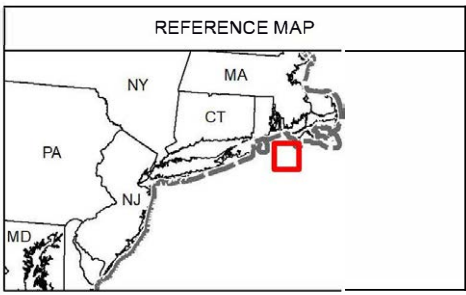
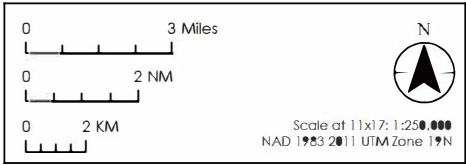

This page intentionally left blank

CONSTRUCTION AND OPERATIONS PLAN

Site Characterization and Assessment of Impacts – Biological Resources

Table 4.4.2-1 Description of General Macrohabitat Types Observed at the SRWF, SRWEC–OCS, and Reference Areas

Macrohabitat Type	Physical Habitat Stability	CMECS Substrate Group/Subgroups	CMECS Benthic Biotic Subclass	Specific Benthic Taxa Likely Present (see Table 3.2-2 in Appendix M1 for a comprehensive list)	Spatial Prevalence in Surveyed Area
Sand and mud	Stable	Sand or Finer/Very Fine Sand, Fine Sand	Soft Sediment Fauna	Burrowing Anemone (cerianthids); Jonah crab (<i>Cancer borealis</i>); Horseshoe crab (<i>Limulus polyphemus</i>); Ocean quahog (<i>Arctica islandica</i>); Sand dollar (<i>Echinorachnius parma</i>); Sea scallop (<i>Placopecten magellanicus</i>); surfclam (<i>Spisula solidissima</i>); Channeled whelk (<i>Busycotypus canaliculatus</i>); Amphipods species; Sea star species	Very common

Example PV Image Replicates: Sand and mud



CONSTRUCTION AND OPERATIONS PLAN

Site Characterization and Assessment of Impacts – Biological Resources

Macrohabitat Type	Physical Habitat Stability	CMECS Substrate Group/Subgroups	CMECS Benthic Biotic Subclass	Specific Benthic Taxa Likely Present (see Table 3.2-2 in Appendix M1 for a comprehensive list)	Spatial Prevalence in Surveyed Area
Sand with ripples	Mobile	Sand or Finer/Fine Sand, Medium Sand, Coarse Sand	Soft Sediment Fauna	Jonah crab (<i>Cancer borealis</i>); Horseshoe crab (<i>Limulus polyphemus</i>); Ocean quahog (<i>Arctica islandica</i>); Sand dollar (<i>Echinorachnius parma</i>); Sea scallop (<i>Placopecten magellanicus</i>); surfclam (<i>Spisula solidissima</i>); Channeled whelk (<i>Busycotypus canaliculatus</i>); Amphipods species; Sea star species; Sand shrimp	Very common

Example PV Image Replicates: Sand with ripples



CONSTRUCTION AND OPERATIONS PLAN

Site Characterization and Assessment of Impacts – Biological Resources

Macrohabitat Type	Physical Habitat Stability	CMECS Substrate Group/Subgroups	CMECS Benthic Biotic Subclass	Specific Benthic Taxa Likely Present (see Table 3.2-2 in Appendix M1 for a comprehensive list)	Spatial Prevalence in Surveyed Area
Sand with mobile gravel	Mobile	Gravelly Sand, Sandy Gravel	Soft Sediment Fauna	Sea grape tunicate (<i>Mogula</i> sp.); Lobster (<i>Homarus americanus</i>); Jonah crab (<i>Cancer borealis</i>); Sea scallop (<i>Placopecten magellanicus</i>); Hermit crab (<i>Paguroid</i> spp.); shrimp; cerianthid; moon snail; Amphipods (Podoceridae); hydroids (<i>Tubularia</i> sp.)	Limited

Example PV Image Replicates: Sand with Mobile Gravel



CONSTRUCTION AND OPERATIONS PLAN

Site Characterization and Assessment of Impacts – Biological Resources

Macrohabitat Type	Physical Habitat Stability	CMECS Substrate Group/Subgroups	CMECS Benthic Biotic Subclass	Specific Benthic Taxa Likely Present (see Table 3.2-2 in Appendix M1 for a comprehensive list)	Spatial Prevalence in Surveyed Area
Patchy cobbles & boulders on sand	Mix of mobile & stable	Sandy Gravel, Gravelly Sand, Gravel Mixes, Boulder	Attached Fauna; Soft Sediment Fauna	Anemones; Lobster (<i>Homarus americanus</i>); Jonah crab (<i>Cancer borealis</i>); Sea pens (Pennatulidae); Sea scallops (<i>Placopecten magellanicus</i>); Shrimp; Squid (Loliginidae); Sponge species (<i>Polymastia</i> sp.); shrimp; sea stars; Northern Star coral (<i>Astrangia poculata</i>); hydroids (<i>Tubularia</i> sp.)	Limited

Example PV Image Replicates: Patchy Cobbles and Boulders on Sand



Figure 4.4.2-4
Maximum CMECS
Gravel Size Category (PV)
Sunrise Wind | Powered by Ørsted & Eversource

- Legend**
- Sunrise Wind Farm (SRWF)
 - Offshore Converter Station (OCS-DC)
 - Sunrise Wind Export Cable (SRWEC-OCS)
 - 3 Nautical Mile State Water Boundary
 - Reference Area

Maximum CMECS Gravel Size Category (PV)

- Boulder
- Cobble
- Pebble/Granule
- Indeterminate
- Not Applicable

Sources

1. Base map: USGS The National Map

Date	11/30/2020
Project Number	
Prepared By	
Reviewed By	

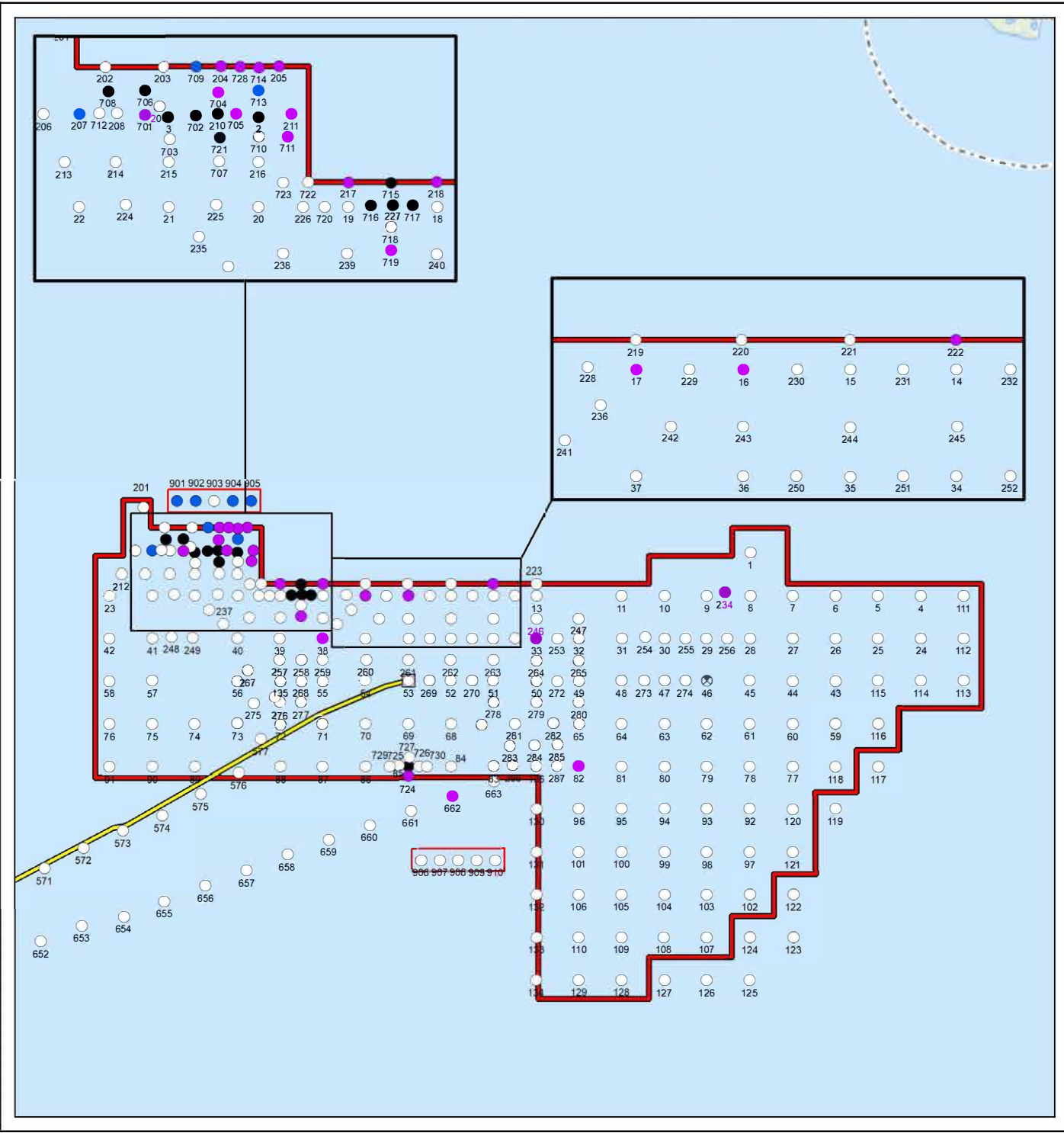
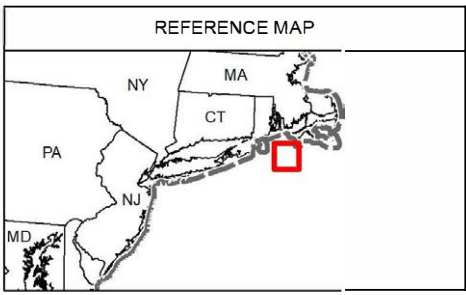
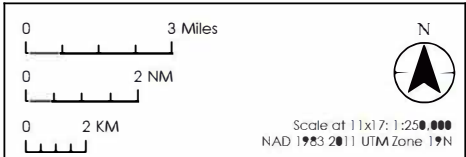

This page intentionally left blank

CONSTRUCTION AND OPERATIONS PLAN

Site Characterization and Assessment of Impacts – Biological Resources

Sunrise Wind Export Cable–OCS

Several studies have characterized the seafloor within the New York Bight region in the area where the proposed SRWEC–OCS is located. The NYSDOS commissioned the Offshore Atlantic Ocean Study to better understand the biological and physical characteristics of the OCS waters (NYSDOS 2013). This study, which encompassed the New York Offshore Planning Area (OPA) (an area roughly the extent of the New York Bight), includes the area immediately west of the RI-MA WEA. This dataset covers some of the SRWEC–OCS (Figure 4.4.2-1) and suggests a high likelihood of fine to coarse sand with areas of granules and pebbles (i.e., small, mobile gravels) along the SRWEC–OCS route. A habitat mapping study that predicts the benthic habitat across the Northwest Atlantic corroborates the results of the NYSDOS Offshore Atlantic Ocean Study, finding that sediments in both the SRWF and SRWEC–OCS corridor range from fine-grained to medium- and coarse-grain sand (Greene et al. 2010).

The site-specific SPI/PV survey found there were two distinct regions of the SRWEC–OCS that differed based on sediment composition and benthic community: (1) the western SPI/PV stations extending from the 13-nm NYS waters boundary to where the planned cable corridor redirects northeastward and (2) the eastern SPI/PV stations that include the remaining stations along the SRWEC–OCS extending to the SRWF. The western portion of the SRWEC–OCS was composed primarily of the macrohabitat types *sand with ripples* and *sand and mud with ripples* (Figure 4.4.2-5). The eastern portion of the SRWEC–OCS was generally composed of *sand and mud* with no ripples (Figure 4.4.2-6).

There were spatial trends associated with the physical features along the SRWEC–OCS, notably a transition from Medium Sand and Fine Sand (CMECS Substrate Subgroups) with ripples in the western extent to Very Fine Sand with limited small-scale bedforms along the eastern portion of the SRWEC–OCS (Appendix M1). This spatial distribution of seabed composition was also reflected in the biological component of the benthic environment along the SRWEC–OCS. Generally, the western portion of the SRWEC–OCS was characterized by high densities of sand dollars and evidence of mobile epifauna (tracks). This corroborates previous reports in the area that also observed high occurrences of sand dollars and sand ripples in this general area (e.g., NYSERDA 2017b). While the eastern portion of the SRWEC–OCS was inhabited by sea stars, cerianthids (burrowing anemone), mobile crustaceans, tube-building amphipods and polychaetes, and deep-burrowing polychaetes (Appendix M1; Table 4.4.2-1). Gravel did not make up a substantial proportion of the sediments along the SRWEC–OCS and was not greater than 5 percent cover at any SPI/PV station, with the exception of two stations both of which were composed of Gravelly Sand (CMECS Substrate Subgroup; i.e., 5-30 percent cover of gravel): Station 537 in the central part of the SRWEC–OCS and Station 662 located adjacent to the SRWF). At both of these SPI/PV stations the macrohabitat type was documented to be *sand with mobile gravel* (Figure 4.4.2-6), the maximum gravel size was pebble/granule, and there was no observed attached epifaunal growth (Appendix M1). No boulders were observed at any of the SPI/PV stations along the SRWEC–OCS. Sea scallops were observed at six stations along the SRWEC–OCS, all of which occurred in the eastern portion of the planned cable (Appendix M1).

This page intentionally left blank

**Figure 4.4.2-5
Macrohabitat (SPI/PV)**

Sunrise Wind | Powered by Ørsted & Eversource

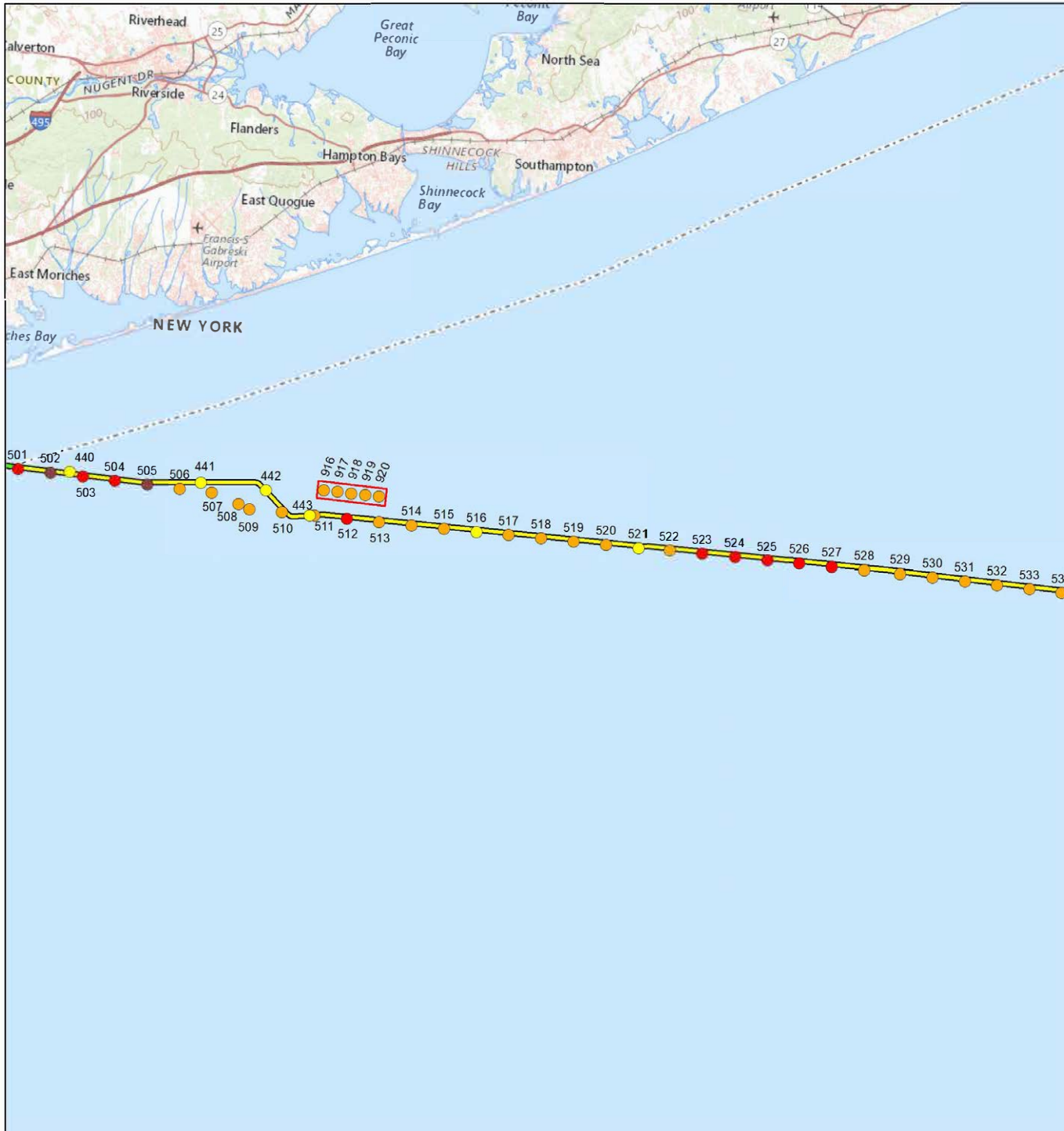

Legend

- Sunrise Wind Export Cable (SRWEC-OCS)
- 3 Nautical Mile State Water Boundary
- Reference Area

Macrohabitat (SPI/PV)

- Cobbles and boulders on sand
- Patchy cobbles and boulders on sand
- Sand with mobile gravel
- Sand with ripples
- Sand and mud with ripples
- Sand
- Sand and mud
- Indeterminate

Sources

- Base map: USGS The National Map

Date	11/30/2020
Project Number	
Prepared By	
Reviewed By	

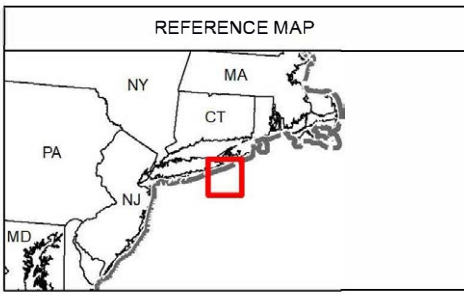
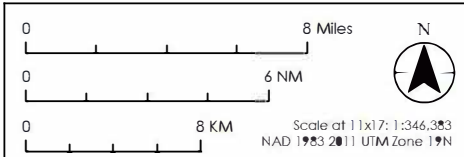

This page intentionally left blank

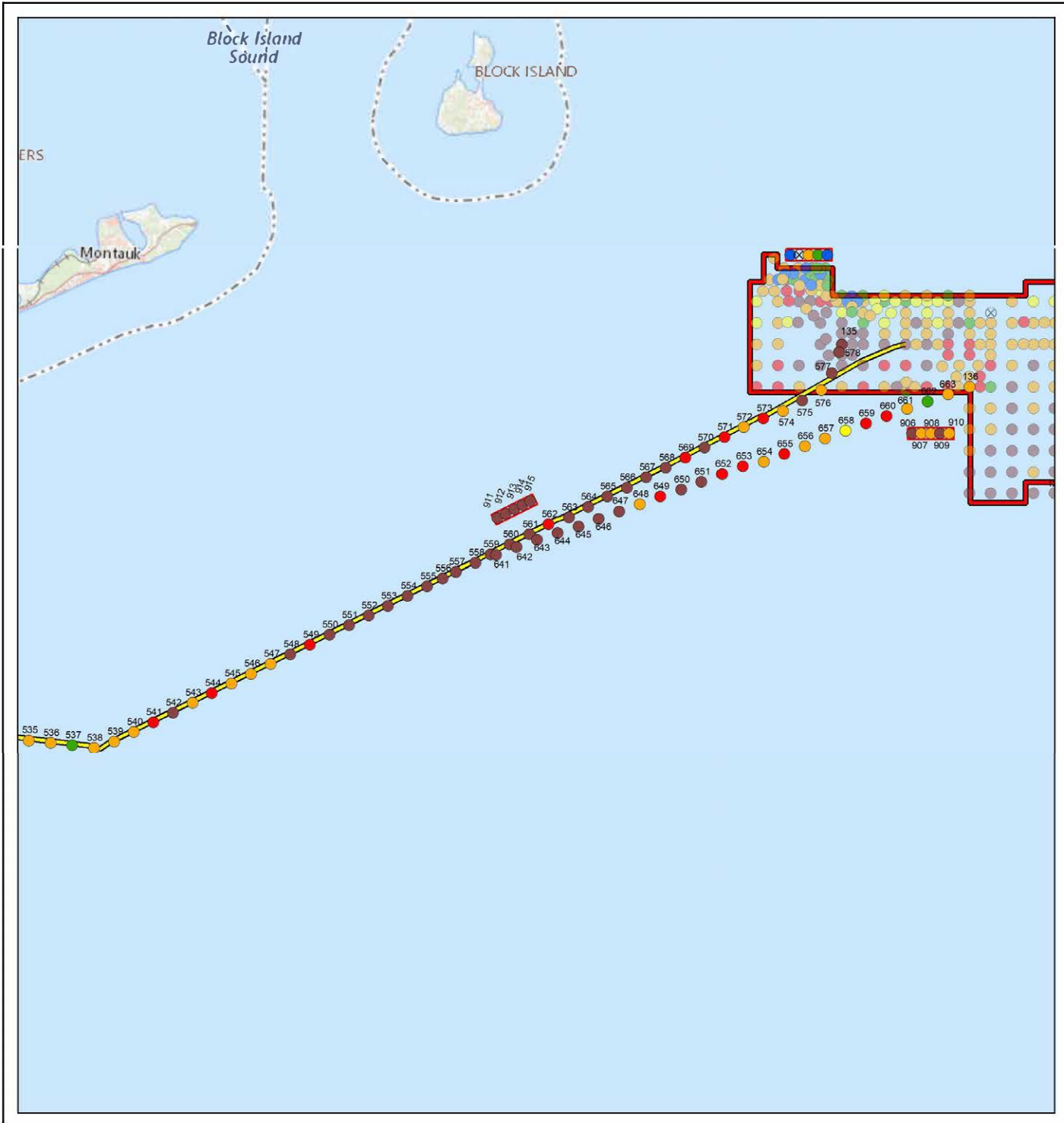

**Figure 4.4.2-6
Macrohabitat (SPI/PV)**

Sunrise Wind | Powered by Ørsted & Eversource

Legend

- Sunrise Wind Farm (SRWF)
- Sunrise Wind Export Cable (SRWEC-OCS)
- 3 Nautical Mile State Water Boundary
- Reference Area

Macrohabitat (SPI/PV)

- Cobbles and boulders on sand
- Patchy cobbles and boulders on sand
- Sand with mobile gravel
- Sand with ripples
- Sand and mud with ripples
- Sand
- Sand and mud
- Indeterminate

Sources

- Base map: USGS The National Map

Date	11/30/2020
Project Number	
Prepared By	
Reviewed By	

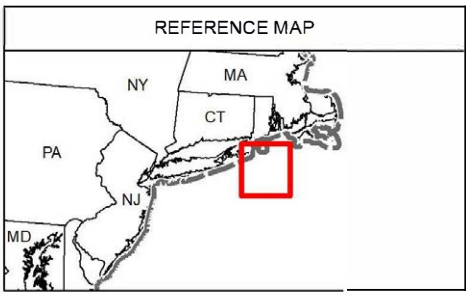
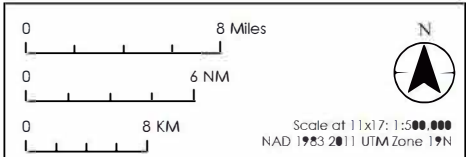

This page intentionally left blank

CONSTRUCTION AND OPERATIONS PLAN

Site Characterization and Assessment of Impacts – Biological Resources

Sunrise Wind Export Cable–NYS

The SRWEC–NYS enters state waters of New York along the Long Island inner continental shelf and continues to Fire Island, the barrier island that divides Long Island and Great South Bay from the Atlantic Ocean. Several geomorphological mapping studies of the inner continental shelf along the length of Fire Island generally characterize the area east of Watch Hill, in the vicinity of the SRWEC–NYS, as being composed of asymmetric, sorted bedforms dominated by fine-grained sands surrounding isolated coarse sand zones (Goff et al. 2015; Lui et al. 2018; Schwab et al. 2014). Several studies have documented the physical environment in this region, including benthic substrate composition, particularly after Hurricane Sandy in 2012, which resulted in drastic changes to the geomorphology of Fire Island (Schwab et al. 2017; Warner et al. 2017). Geotechnical and geophysical surveys conducted by BOEM in 2015 and 2016 characterized the stratigraphy in the region with a focus on the extensive sand ridges along the western Long Island shelf and detailed the movement of modern sand westward in the coastal areas south of Fire Island (APTIM 2018). This westward movement of sand along the Fire Island inner continental shelf is well-documented and results in extensive sand waves and ridges. A site-specific SPI/PV benthic assessment surveys along the SRWEC–NYS was conducted in August 2020, results of which are presented in Appendix M2 and summarized here.

Macrohabitat types along the SRWEC–NYS SPI/PV stations were classified as either *sand with ripples*, *sand*, or *sand and mud* (Figure 4.4.2-7). In general, sand ripples were more frequently observed at the stations closest to shore. The predominant CMECS Substrate Subgroups characterized along the SRWEC–NYS were Very Fine Sand or Fine Sand and all SPI/PV stations were classified with the CMECS Biotic Subclass of Soft Sediment Fauna (Appendix M2). Along the SRWEC–NYS, no more than 5 percent cover of gravel was observed in any given PV replicate, and no boulders or cobbles were observed. The soft sediment faunal communities along the SRWEC–NYS were generally characterized by the presence of small burrows, tubes, and tracks. Sand dollars, burrowing anemones (cerianthids), and tube-building polychaetes (*Diopatra* sp.) were frequently observed along the SRWEC–NYS (Appendix M2). No sensitive taxa, species of concern, or non-native species were observed at any of the SPI/PV stations along the SRWEC–NYS.

Onshore Facilities

To the north of Fire Island is Great South Bay, which is further divided into smaller embayments, including Moriches Bay, Narrow Bay, and Bellport Bay. As planned, the Onshore Transmission Cable will transit under a narrow channel between Bellport Bay and Narrow Bay near Smith Point County Park in the Town of Brookhaven, New York. A site-specific SPI/PV and drop-camera video survey was conducted in the summer of 2020 within the ICW to assess the benthic environment and document sea grass in the vicinity of the proposed HDD route. Results from this survey are presented in Appendix M2 and summarized below.

CONSTRUCTION AND OPERATIONS PLAN

Site Characterization and Assessment of Impacts – Biological Resources

A recent study by the NPS (LaFrance Bartley et al. 2018) investigated and mapped benthic habitats at sites along the northern shore of Fire Island and near the recent breach (East Breach, also called Old Inlet Breach) to Bellport Bay that was formed after Hurricane Sandy in 2012. The study found these shallow areas to be predominantly sandy, with distinct sand flats, sand waves, and small sand dunes. In locations east of the new breach and west of Smith Point are areas of dense amphipod tube-mats (*Ampelisca spp.*) associated with clay-silt substrate, mature dense blue mussel beds in both coarse sand and clay-silt environments, and patches of seagrass (both *Ruppia maritima* and *Zostera marina*) in sandy substrate (LaFrance Bartley et al. 2018). The opening of the inlet (East Breach or Old Inlet Breach) to Bellport Bay created extensive changes to the flushing and circulation dynamics as well as salinity and light availability, all of which influence the benthic communities, generally improving water and sediment quality in this region (Gobler et al. 2019).

The site-specific SPI/PV survey in August 2020 documented that CMECS Substrate Subgroup at stations in the ICW HDD ranged from Sand or Finer to Gravel Mixes, with larger grain sizes occurring in the central channel region (channel between Bellport Bay and Narrow Bay) compared to the stations flanking the channel. SPI/PV stations in the ICW HDD that were classified with a Biotic Subclass of Attached Fauna were co-located at stations composed of gravel, and the mobile sand present at the other stations in the ICW HDD were classified with the Biotic Subclass of Soft Sediment Fauna. No sensitive fauna, species of concern, or non-native species were observed at any of the SPI/PV stations at the ICW HDD (Appendix M2).

During the site-specific video survey in August 2020, a total of 6 individual SAV shoots were observed that were distributed several meters apart on the north side of the channel between Bellport Bay and Narrow Bay within dense macroalgal beds. SAV was not observed on the south side of the channel (Appendix M2), despite an SAV bed being documented in this area previously (NYDOS 2020). Dense macroalgal beds were observed across numerous video transects mainly along the northern side of the channel.

Bivalve restoration projects, including oysters and hard clams, are ongoing in Bellport Bay, in collaboration with the Town of Brookhaven, Cornell Cooperative Extension Marine Program, and Friends of Bellport Bay. Over the past several years, hatchery-reared juvenile oysters and hard clams sourced from the mariculture facility on Cedar Beach in Mt Sinai have been planted at locations within Bellport Bay, including near Ridge Island (White 2015), which is approximately 2.2 mi (1.9 nm, 3.5 km) from the planned ICW HDD corridor. In addition to this ongoing restoration work, in 2018 and 2019, the NYSDEC Long Island Shellfish Restoration Initiative, in collaboration with Cornell Cooperative Extension, Stony Brook University, municipalities, local businesses, and volunteer organizations, established a shellfish sanctuary site in Bellport Bay with the goals of improving water quality, restoring native shellfish populations and biodiversity, and creating jobs and educational opportunities (NYSDEC 2021). This hard clam sanctuary, which was stocked with adult and juvenile clams, is located near the mouth of Carmans River (Figure 4.4.2-2). An oyster restoration area, established and maintained by the Friends of Bellport Bay, is located west of the Bellport Yacht Club (Figure 4.4.2-2). Monitoring is ongoing to evaluate water quality improvements and shellfish enhancement (Barnes 2018). Bivalves serve important ecological function by improving water quality through filtration and facilitating sediment nitrogen cycling processes that may remove nitrogen pollution from the ecosystem (e.g., Kreeger et al. 2018).

CONSTRUCTION AND OPERATIONS PLAN

Site Characterization and Assessment of Impacts – Biological Resources

Previous hard clam restoration efforts in Bellport Bay failed likely due to stressors including high nitrogen levels that fuel frequent brown tides (*Aureococcus anophagefferens*) in the area and are detrimental to hard clams (Bricelj et al. 2001). However, the recent breach (Hurricane Sandy in 2012) that created an inlet from the Atlantic Ocean into Bellport Bay may improve water quality and support bivalve production (Gobler et al. 2019). Natural hard clam populations in Bellport Bay are evaluated biannually by the Town of Brookhaven; most recent data show densities range from 0 to 16 clams per m² within the Bay (Figure 4.4.2-2).

This page intentionally left blank

**Figure 4.4.2-7
Macrohabitat (SPI/PV)**

**Sunrise
Wind**

Powered by
Ørsted &
Eversource

Legend

-  SRWEC Landfall Location
-  Sunrise Wind Export Cable (SRWEC-NYS)
-  Sunrise Wind Export Cable (SRWEC-OCS)
-  3 Nautical Mile State Water Boundary

Macrohabitat (SPI/PV)

-  Sand with ripples
-  Sand
-  Sand and mud
-  Indeterminate

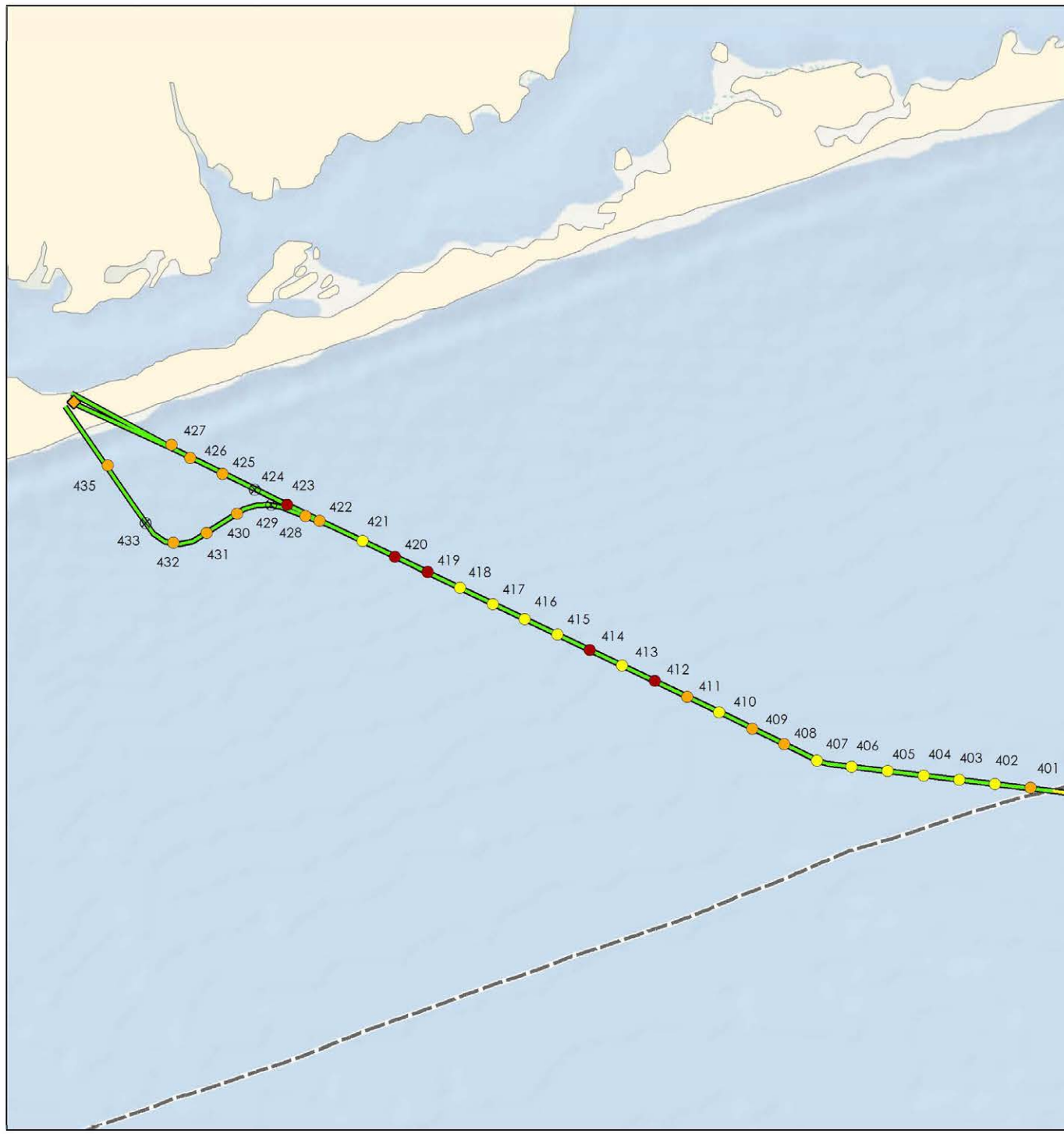

Date	11/30/2020
Project Number	
Prepared By	
Reviewed By	

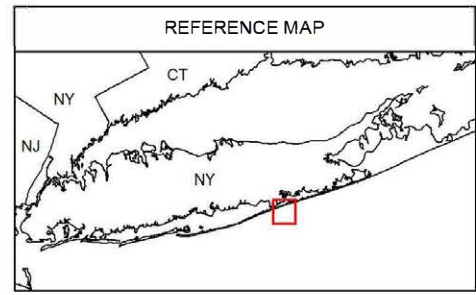
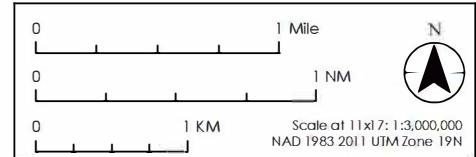

This page intentionally left blank

CONSTRUCTION AND OPERATIONS PLAN

Site Characterization and Assessment of Impacts – Biological Resources

4.4.2.2 Potential Impacts

Construction, O&M, and decommissioning activities associated with the SRWF and SRWEC have the potential to cause both direct and indirect impacts on the benthic and shellfish resources of the affected environment that are discussed above. Impacts will vary by habitat, species, and life stage, with some species/life stages being more vulnerable than others. IPFs associated with the construction and O&M phases of the Project are identified on Figure 4.4.2 and described separately, by phase, for the SRWF and SRWEC in the following sections. For the decommissioning phase of the Project, impacts are anticipated to be similar to or less adverse than those described for construction; therefore, impacts from decommissioning are not addressed separately in this section, with one exception. The Project's introduction of complex habitat in the offshore environment is expected to result in *beneficial* impacts, which would then be reversed at the time of decommissioning. This reversal of beneficial effects is discussed briefly below. Onshore Facilities will not have direct or indirect impacts on benthic and shellfish resources as Bellport Bay will be crossed via the ICW HDD. Sunrise Wind will develop an Inadvertent Return Plan prior to construction that will describe the measures that would be implemented to prevent and identify inadvertent releases of drilling fluid. Supporting information and results of benthic surveys are also presented in Appendix M1.

CONSTRUCTION AND OPERATIONS PLAN

Site Characterization and Assessment of Impacts – Biological Resources

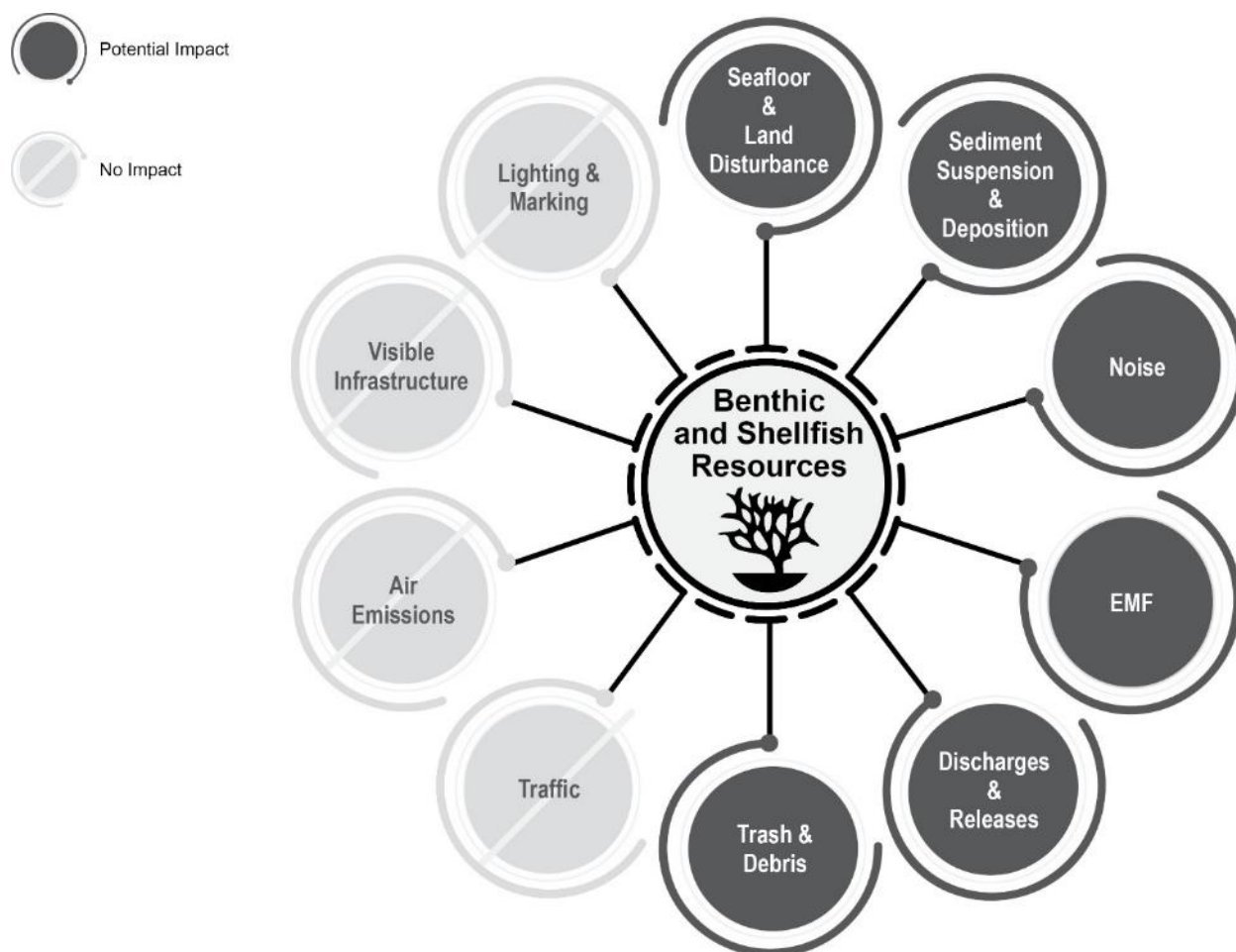

Figure 4.4.2-8 Impact-Producing Factors on Benthic and Shellfish Resources

Sunrise Wind Farm

During SRWF construction, seafloor disturbance and sediment suspension/deposition are expected to affect sessile species and organisms with limited mobility, including early life stages (e.g., larvae and eggs) more than mobile species. However, these impacts, as well as impacts associated with construction noise, are expected to be temporary and cease when construction activity stops. During O&M of the SRWF, impacts associated with seafloor disturbance, sediment suspension/deposition, and noise are expected to be similar but lesser in extent compared to construction. Seafloor disturbance activities that result in the conversion of soft sediment habitats to hard bottom habitat associated with foundations, scour protection, and cable protection (e.g., concrete mattresses or rock berms) along portions of the IAC routes, is expected to have long-term beneficial impacts on benthic organisms that rely on complex, hard bottom habitats. Benthic habitat recovery and the recolonization by benthic infaunal and epifaunal species may take up to 1 to 3 years (e.g., AKRF Inc. et al. 2012; Germano et al. 1994; INSPIRE 2016; Hirsch et al. 1978; Kenny and Rees 1994). Inadvertent discharges/releases, trash and debris, and EMF are expected to have insignificant impacts on benthic and shellfish

CONSTRUCTION AND OPERATIONS PLAN

Site Characterization and Assessment of Impacts – Biological Resources

resources during construction and O&M of the SRWF. None of the IPFs are expected to result in population-level effects on benthic species, due to the scale and intensity of the Project activities, and the availability of similar habitat in the surrounding area. The impacts discussed in this section would vary slightly by habitat composition within the SRWF.

Construction

Seafloor Disturbance

Seafloor-disturbing activities will include seafloor preparation, impact and/or vibratory pile driving/foundation installation, IAC installation, and vessel anchoring (including spuds from jack-up vessels). These activities could cause injury or mortality to benthic species and negatively affect their habitats. The impacts associated with these activities will be local and will cease after the construction is complete in a given area. Seafloor disturbance and habitat alteration will encompass a small portion of similar available benthic habitat in the area.

Boulder clearance associated with seafloor preparation is expected to have direct impacts on benthic and shellfish resources in the limited areas it may be required along the IAC corridor and around individual foundations. Loss of attached fauna is expected during boulder relocation. Boulders will be placed in new locations, creating new physical configurations in relation to nearby boulders and are not expected to return to pre-Project conditions. However, these relocated boulders are expected to return to their pre-Project habitat function with relatively rapid (< 1 year) recolonization expected (Guarinello and Carey 2020). Additionally, boulder relocation may result in aggregations of boulders, creating new features that may serve as high value habitat. For example, this increased complex structured habitat may benefit juvenile lobsters and fish by providing an opportunity for refuge compared to surrounding patchy habitat.

If necessary, CFE or suction hopper dredging may be used for sand wave leveling during installation of the IAC. This method utilizes thrust to direct waterflow into sediment, creating liquefaction and subsequent dispersal. The CFE tool draws in seawater from the sides and then jets this water out from a vertical down pipe at a specified pressure and volume. The water withdrawal volumes are expected to be approximately 250 to 650 million gallons (946 to 2,460 million liters) for the jet-plow and approximately 191 to 516 million gallons (724 to 1,953 million liters) for CFE equipment. The down pipe is positioned over the cable alignment, enabling the stream of water to fluidize the sands around the cable, which allows the cable to settle into the trench under its own weight. During the process, the fluidized sand gets deposited within the local sand wave field. Local impact caused by entrainment of zooplankton and ichthyoplankton during hydraulic plowing or dredging can lead to mortality. These losses are expected to be very low based on a previous assessment conducted for the South Fork Wind Farm, which found that the total estimated losses of zooplankton and ichthyoplankton from jet plow entrainment were less than 0.001 percent of the total zooplankton and ichthyoplankton abundance present in the study area, which encompassed a linearly buffered region of 9 mi (15 km) around the export cable and 16 mi (25 km) around the wind farm (INSPIRE Environmental 2018). The impacts to eggs and larvae from CFE are expected to be similar to those observed from jet plow trenching and are not expected to result in population-level impacts.

CONSTRUCTION AND OPERATIONS PLAN

Site Characterization and Assessment of Impacts – Biological Resources

The remaining seafloor preparation activities, IAC installation, and installation of cable protection will also occur along the IAC corridor and around individual foundations and are expected to have similar direct short-term impacts on benthic and shellfish resources as boulder clearance in these areas. The impacts from these activities are expected to affect sessile and slow-moving organisms differently than mobile benthic species, and impacts would vary with bottom type as well as cable installation methodology. Sessile and slow-moving benthic species, including infaunal species, eggs, and larvae, that cannot avoid seafloor preparation or cable installation equipment, may be subject to mortality and injury if they are present within the impact area during construction.

The installation of the WTG and OCS–DC foundations and associated scour protection could also crush and/or displace benthic species, particularly sessile species and eggs and larvae within the impact area of the foundations and scour protection. Because of the slow speed of the seafloor preparation and cable installation equipment and limited size of the impact areas, it is expected that most mobile benthic species will be able to avoid these activities and will not be subject to mortality or injury but may still experience some direct impact.

Vessel anchoring (including spuds from jack-up vessels) could cause mortality or injury to slow-moving or sessile benthic species within the impact areas of the spuds, anchors, and anchor chain sweep. The extent of vessel anchoring impacts will vary, depending on the vessel type, number of vessels, and duration onsite, but would be smaller in spatial extent than other seafloor-disturbing construction activities.

In areas of seafloor disturbance, benthic habitat recovery and mobile and sessile benthic infaunal and epifaunal species abundances may take up to one to three years to recover to pre-impact levels, based on the results of a number of studies on benthic recovery (e.g., Guarinello and Carey 2020; INSPIRE 2016, AKRF, Inc. et al. 2012; Germano et al. 1994; Hirsch et al. 1978; Kenny and Rees 1994). Based on a review of impacts of sand mining in the US Atlantic and Gulf of Mexico, softbottom communities within the cable corridors would recover within 3 months to 2.5 years (Kraus and Carter 2018; BOEM 2015; Normandeau 2014; Brooks et al. 2006). A separate review of case studies from cable installations in Atlantic and Pacific temperate zones concludes that recovery of benthic communities on the OCS (less than 262 ft [80 m] depth) occurs within a few weeks to two years after plowing, depending on the available supply of sediment (Brooks et al. 2006). Recovery time also varies somewhat with the method of installation, with more rapid recovery after plowing than jetting (Kraus and Carter 2018). Benthic habitat recolonization rates depend on the benthic communities in the area surrounding the affected region. Sand sheet and mobile sand with gravel habitats as found within and near the SRWF are often more dynamic in nature; therefore, they are quicker to recover than more stable environments, such as fine-grained (e.g., silt) habitats and rocky reefs (Dernie et al. 2003). Species inhabiting these dynamic habitats are adapted to deal with physical disturbances, for example, frequent sedimentation associated with strong bottom currents and ground swell. As such, these communities are expected to recolonize more quickly after a disturbance than communities not well-adapted to frequent disturbance (e.g., cobble and boulder habitats). Mobile species may also be indirectly affected by the temporary reduction of benthic forage species; however, given the prevalence of similar habitat in the area, this is likely to be a minor impact.

CONSTRUCTION AND OPERATIONS PLAN

Site Characterization and Assessment of Impacts – Biological Resources

Sediment Suspension and Deposition

Seafloor-disturbing activities will result in temporary increases in sediment suspension and deposition. Sediment transport modeling was performed using the Particle Tracking Model (PTM) in the Surface-Water Modeling System, which is a two-dimensional Lagrangian particle tracking model developed by the Coastal Inlets Research Program (CIRP) and the Dredging Operations and Environmental Research Program (DOER) at the USACE Research and Development Center. The PTM required input bottom currents (velocity and direction), which were obtained from the Northeast Coastal Ocean Forecast System hydrodynamic model. The models, inputs, and results are described in detail in Appendix H.

Several model simulations were run to evaluate the concentrations of suspended sediments, spatial extent and duration of sediment plumes, and the seafloor deposition resulting from IAC burial activities. The grain size distributions used for modeling were based on grab samples from federal waters collected during field studies performed for the Project (Appendix G1), and USGS sediment data for NYS waters (USGS 2014). The sediment transport modeling results are summarized in Table 4.4.2-2, including the maximum distance of the predicted TSS plumes from the cable corridor centerline, the expected time for elevated TSS to return to ambient conditions, the maximum distance of sediment deposition from the cable corridor centerline of a threshold thickness of > 0.4 in (10 mm), and the area of sediment deposition of a threshold thickness of > 0.4 in (10 mm).

For the IAC, two representative segments of installation by jet plow were simulated and the modeling results indicate that sediment plumes with TSS concentrations exceeding the ambient conditions by 100 mg/L could extend up to 3,346 ft (1,020 m) from the cable corridor centerline. The model estimated that the elevated TSS concentrations would be of short duration and are expected to return to ambient conditions within 0.5 hours following the cessation of cable burial activities. The modeling results also indicate that sedimentation from IAC burial is expected to exceed 0.4 in (10 mm) of deposition a maximum of 220 ft (67 m) from the cable centerline covering an area of 3.0 ha (7.4 acres) of the seafloor, and the TSS plume is predicted to be primarily contained within the lower portion of the water column, approximately 12.8 ft (3.9 m) above the seafloor.

CONSTRUCTION AND OPERATIONS PLAN

Site Characterization and Assessment of Impacts – Biological Resources

Table 4.4.2-2 Summary of the Sediment Transport Modeling Results

Project Component	Installation Equipment	Location	Max Time for TSS to Return to Ambient (hours)	Max Distance of TSS Plume (ft)		Max Distance of Sediment Deposition (ft)	Area of Sediment Deposition (ac)
				>50 mg/L Above Ambient	>100 mg/L Above Ambient		
SRWEC	Jet Plow	NY State Waters	0.3	NA	NA	253	453.1
		Federal Waters	0.4	8,996	2,969	791	4832.3
	YSHD or CFE Island Wave Leveling ¹	NY State Waters	0.5	13,310	6,775	2,903	75.6
		Federal Waters	0.4	8,340	5,052	1,427	174.2
HDD Exit Pit	Mechanical Dredging	NY State Waters	0.3	NA	NA	79	0.25
IAC	Jet Plow	Federal Waters	0.5	7,815	3,346	220	7.4
NOTE:							
¹ Summary values of the outcomes from the most conservative scenarios are provided							

Suspension of sediments into the water column and the redistribution of sediments that fall out of suspension could result in mortality of benthic organisms through smothering and irritation to respiratory structures, particularly sessile species and species with limited mobility. Mobile organisms are expected to temporarily vacate the area and move out of the way of incoming sediments (MMS 2007). Most marine species have some degree of tolerance to higher concentrations of suspended sediment because storms, currents, and other natural processes regularly result in increases in turbidity (MMS 2009). However, eggs and larval organisms are especially susceptible to smothering through sedimentation. Also, smaller organisms are likely more affected than larger organisms, as larger organisms may be able to extend feeding tubes and respiratory structures above the sediment (U.K. Department for Business Enterprise and Regulatory Reform 2008).

Maurer et al. (1986) found that several species of marine benthic infauna (e.g., the clam *Mercenaria*, the amphipod *Parahaustorius longimerus*, and the polychaetes *Scoloplos fragilis* and *Nereis succinea*) exhibited little to no mortality when buried under up to 3 in (8 cm) of various types of sediment (from predominantly silt-clay to pure sand). The modeling results indicate that sedimentation from IAC construction can be expected to exceed 0.4 in (10 mm) of deposition out to 220 ft from the jet plow activity, with a total of 7.4 acres of seafloor that may experience > 0.4 in of sediment deposition during construction.

As discussed above, following a seabed disturbance, benthic habitat recovery may take up to 1 to 3 years and for benthic organism abundances to return to pre-impact numbers (e.g., AKRF, Inc. et al. 2012; Germano et al. 1994; Hirsch et al. 1978; Kenny and Rees 1994; Kraus and Carter 2018; BOEM 2015; Normandeau 2014; Brooks et al. 2006). Recovery time also varies somewhat with the method of installation, with more rapid recovery after plowing than jetting (Kraus and Carter 2018).

CONSTRUCTION AND OPERATIONS PLAN

Site Characterization and Assessment of Impacts – Biological Resources

Benthic habitats within and near the SRWF, including sand sheet and mobile sand with gravel, are dynamic in nature and as such, the benthic organisms are generally adapted to disturbances associated with natural sediment resuspension and deposition events (e.g., storms, tidal currents, circulation). Therefore, these benthic communities recover more quickly than communities inhabiting more stable environments such as fine-grained (e.g., silt) habitats and rocky reefs (Dernie et al. 2003). In areas with cobble and boulder habitat, the benthic organisms are not well adapted to frequent sedimentation and, therefore, may take longer to begin to recolonize after the disturbance.

Noise

Several sources of noise are expected during construction of the SRWF, including construction equipment, pile driving, and vessels. It is thought that marine invertebrates are sensitive to particle motion rather than sound pressure, detecting acoustic energy with sensory organs such as mechanoreceptor hairs, chordotonal organs, statocysts and statoliths (Vella et al. 2001; Popper and Hawkins 2018; Jones et al. 2020). Several studies have documented the responses of different marine invertebrates to natural and anthropogenic vibration, although no exposure criteria have been established (as reviewed in Roberts and Elliot 2017).

Several recent studies have focused on determining threshold detection and responses of cephalopods to underwater noise. Cephalopods, including cuttlefish, octopus, and squid species, are sensitive to particle motion rather than sound pressure (e.g., Packard et al. 1990; Mooney et al. 2010), with the lowest particle motion thresholds reported at 1 to 2 Hz (Packard et al. 1990). Particle motion thresholds were measured for longfin squid between 100 and 300 Hz, with a threshold of 110 dB re 1 μ Pa reported at 200 Hz (Mooney et al. 2010). No other studies have measured particle motion. Specific hearing thresholds for sound pressure at higher frequencies have been reported for the oval squid (*Sepioteuthis lessoniana*) and the common octopus (134 and 139 dB re 1 μ Pa at 1,000 Hz, respectively) (Hu et al. 2009).

Cephalopods appear to be particularly sensitive to low frequency sound. Sole et al. (2017) estimated that trauma onset may begin to occur in cephalopods at sound pressure levels (SPL_{rms}) from 139 to 142 dB re 1 μ Pa at one-third octave bands centered at 315 Hz and 400 Hz. Low frequency continuous noise (2 hours of 50 to 400 Hz at received SPL_{rms} of 157 dB re 1 μ Pa) resulted in lesions on the sensory hair cells of the statocysts, which worsened over time, in several cephalopod species (André et al. 2016, Sole et al. 2013). At sound frequencies lower than 1,000 Hz, cephalopod behavioral and physiological responses have included inking, locomotor responses, body pattern changes, and changes in respiratory rates (Kaifu et al. 2008; Hu et al. 2009). Common cuttlefish exhibited escape responses (i.e., inking, jetting) when exposed to sound frequencies between 80 and 300 Hz with SPL_{rms} above 140 dB re 1 μ Pa, but they habituated to repeated 200 Hz sounds (Samson et al. 2014).

Decapod crustaceans, including crab, lobster, and shrimp species, detect sound through an array of hair-like receptors within and upon the body surface that potentially respond to water- or substrate-borne vibrations. These organisms also have proprioceptive organs that could serve secondarily to perceive vibrations (as reviewed in Popper et al. 2001). While it is thought that decapod crustaceans would be most sensitive to particle motion, studies have focused on sound pressure level measurements. A change in feeding and stress response in American lobster was observed at an exposure level of 202 dB re 1 μ Pa (Payne and Funds 2007);

CONSTRUCTION AND OPERATIONS PLAN

Site Characterization and Assessment of Impacts – Biological Resources

this exposure level was modelled to occur at up to 1,640 ft (500 m) from the source of pile driving, where particle velocity was estimated to be 0.1 cm s⁻¹ (Miller et al. 2016). Given the experimentally determined sensitivities of blue mussel (*Mytilus edulis*) and common hermit crab (*Pagurus bernhardus*) to particle motion (Roberts et al. 2015; Roberts et al. 2016), this modelled particle velocity would likely elicit behavioral response from these organisms (Roberts and Elliot 2017; Roberts et al. 2017). Prawns (*Palaemon serratus*) showed auditory sensitivity to sounds from 100 to 3,000 Hz (Lovell et al. 2005, 2006). Prawns showed greatest sensitivity at an SPL_{rms} of 106 dB re 1 μPa at 100 Hz, although this was the lowest frequency tested, so prawns might be more sensitive at frequencies below this (Lovell et al. 2005).

Sessile invertebrates such as bivalves may respond to sound exposure by closing their valves (e.g., Kastelein 2008; Roberts et al. 2015; Solan et al. 2016) much as they do when water quality is temporarily unsuitable. In one study, the duration of valve closure was shown to increase with increasing vibrational strength (Roberts et al. 2015). Clams may respond to anthropogenic noise by reducing activity and moving to a position above the sediment-water interface, which affects ecosystem processes such as bioirrigation, as documented in the clam *Ruditapes philippinarum* (Solan et al. 2016).

In response to noise associated with construction at the SRWF, it is expected that mobile macroinvertebrates would temporarily relocate during construction and would not be in the areas of greatest acoustic stressors. Slow start (ramp-up) of pile driving equipment may allow some mobile benthic species to move out of the area and reduce their likelihood of being subject to mortality or injury but they may still experience some direct impact, such as behavioral responses. A recent study found impulsive pile driving noise resulted in a change in squid (*Doryteuthis pealeii*) behavior, with squid exhibiting body pattern changes, inking, jetting, and startle responses (Jones et al. 2020). Indirect impacts on benthic species may also result from a temporary degradation of habitat quality due to elevated noise levels associated with construction activities at the SRWF. Noise from impact pile driving and/or vibratory pile driving may temporarily reduce benthic habitat quality for exposed species.

The effects of underwater noise on benthic invertebrates and shellfish are not well understood, and criteria for assessing injury and mortality have not been established (Morley et al. 2014; Hawkins et al. 2015; Murchy et al. 2019). To evaluate the levels of underwater noise likely to be generated during construction, modeling was conducted using the Marine Operations Noise Model and Full Wave Range Dependent Acoustic Model. These models combine the outputs of the source model with the spatial and temporal environmental context (e.g., location, oceanographic conditions, and seabed type) to estimate acoustic sound fields. Results of the acoustic modeling of impact pile driving activities are presented as single-strike ranges to three exposure criteria, including SPL, sound exposure levels (SEL), and zero-to-peak sound pressure levels (PK). Full acoustic modeling inputs and results are available in Appendix I1.

CONSTRUCTION AND OPERATIONS PLAN

Site Characterization and Assessment of Impacts – Biological Resources

To put the above literature values into context of the proposed construction, the Project-specific acoustic modeling estimated that a single-strike sound pressure level of 190 dB re 1 μ Pa from pile driving under the most conservative scenario (i.e., the greatest range of potential impact) may extend 1,936 ft (590 m) from the activity; the range to the single-strike sound pressure level of 200 dB re 1 μ Pa would be 361 ft (110 m) (Appendix I1). The maximum predicted ranges to potential permanent injury associated with impact pile driving of monopile foundations (and assuming 10 dB attenuation from mitigation measures) was 6.7 mi (12.5 km) for large fish and 10.1 mi (16.3 km) for small fish based on the Fisheries Hydroacoustic Working Group (2008) acoustic thresholds. The comparable ranges based on the Popper et al. (2014) thresholds are a maximum of 0.11 mi (0.18 km) for fish without a swim bladder, 0.9 mi (1.5 km) for fish with a swim bladder involved in hearing, and 0.6 mi (0.9 km) for fish eggs and larvae. Full modeling results are available in Appendix I1. These impacts will be short-lived as habitat suitability is expected to return to pre-pile driving conditions shortly after cessation of pile driving activity.

Sounds created by mechanical /jet plows and vessels are continuous and non-impulsive sounds. Benthic species in the vicinity of Project construction vessels or mechanical/jet plows may be affected by associated noise, but the duration of the disturbance will occur over a very short period at any given location in the SRWF area or between ports and the SRWF. Limited research has been conducted on underwater noise from mechanical/jet plows. Generally, the noise from this equipment is expected to be masked by louder sounds from vessels. The noise generated by vessels will be similar to the range of noise from existing vessel traffic in the region and are not expected to substantially affect the existing underwater noise environment.

Discharge and Releases

Project-related marine vessels operating during construction will be required to comply with regulatory requirements for management of onboard fluids and fuels, including prevention and control of discharges. Trained, licensed vessel operators will adhere to navigational rules and regulations, and vessels will be equipped with spill containment and cleanup materials. Additionally, Sunrise Wind will comply with applicable international (IMO MARPOL), federal (USCG), and state (NY) regulations and standards for reporting treatment and disposal of solid and liquid wastes generated during all phases of the Project. As described in Appendix E1, some liquid wastes will be permitted as discharge into marine waters (i.e., domestic water, deck drainage, treated sump drainage, uncontaminated ballast water, and uncontaminated bilge water); these are not expected to pose an adverse impact to marine resources as they will quickly disperse, dilute, and biodegrade (BOEM 2013).

All vessels will similarly comply with USCG standards regarding ballast and bilge water management. Liquid wastes from vessels (including sewage, chemicals, solvents, and oils and greases from equipment) will be properly stored, and disposal will occur at a licensed receiving facility. As required by 30 CFR 585.626, chemicals to be utilized during the Project are provided in Appendix E1, and in Table 3.3.1-2 and Table 3.3.6-2. Any unanticipated discharges or releases are expected to result in minimal, temporary impacts; activities are heavily regulated and unpermitted discharges are considered accidental events that are unlikely to occur. In the unlikely event that a reportable spill were to occur, the National Response Center would be notified, followed by the EPA, BOEM, and USCG, as outlined in Appendix E1.

CONSTRUCTION AND OPERATIONS PLAN

Site Characterization and Assessment of Impacts – Biological Resources

Trash and Debris

Any active vessel operating within a marine environment has the potential to create trash and debris. However, the discharge or disposal of solid debris into offshore waters from OCS structures and vessels is prohibited by BOEM (30 CFR 250.300) and the USCG (MARPOL, Annex V, Pub. L. 100-220 [101 Stat. 1458]). In accordance with applicable federal, state, and local laws, Sunrise Wind will implement comprehensive measures prior to and during Project construction activities to avoid, minimize, and mitigate impacts related to trash and debris disposal. All trash and debris will be properly stored on vessels for later disposal of on land at an appropriate facility per 30 CFR 585.626(b)(9). Trash and debris will be contained on vessels and offloaded at port or construction staging areas. Food waste that has been ground and can pass through a 25-mm mesh screen may be disposed of according to 33 CFR 151.51-77. All other trash and debris returned to shore will be disposed of or recycled at licensed waste management and/or recycling facilities. Disposal of any other form of solid waste or debris in the water will be prohibited, and good housekeeping practices will be implemented to minimize trash and debris in vessel work areas. These practices will include orderly storage of tools, equipment, and materials, as well as proper waste collection, storage, and disposal to keep work areas clean and minimize potential environmental impacts. With proper waste management procedures, the potential for trash or debris to be inadvertently left overboard or introduced into the marine environment is not anticipated.

Operations and Maintenance

Seafloor Disturbance

Once constructed, the SRWF will result in localized changes to seafloor topography and hydrodynamics due to the presence of foundations, scour protection, and cable protection. The seafloor overlaying the majority of buried IAC (where cable protection will not exist) is expected to return to pre-construction conditions over time and no long-term changes to sediment mobility and depositional patterns are expected. Minimal impacts on benthic species are expected from O&M of the IAC, as they will be buried beneath the seabed. However, seafloor disturbance during O&M of the SRWF may occur during maintenance of bottom-founded infrastructure (e.g., foundations, scour protection, cable protection), anchoring by maintenance vessels for routine maintenance of WTGs or OCS-DC, and non-routine maintenance of the IAC. During O&M, anchoring will be limited to vessels required to be onsite for an extended duration. Effects of these maintenance activities on benthic resources and shellfish are expected to be similar to those discussed for construction of the SRWF, although the extent of disturbance would be limited to specific areas.

The conversion of primarily soft bottom to hard bottom habitat in the form of up to 122 WTGs and an OCS-DC, associated scour protection, and cable protection may result in both negative and beneficial direct long-term impacts on benthic species. Species that have life stages associated with soft bottom habitats, such as ocean quahog, waved and chestnut astarte clam, Atlantic surf clam, sand shrimp, amphipods, channeled whelk, and horseshoe crab, may experience long-term effects as their available habitat will be slightly reduced. Species and life stages that inhabit hard bottom habitats may experience beneficial effects, depending on the quality of the habitat created by the foundations, scour protection, and cable protection, and the composition of the benthic community that colonizes that habitat. Habitat conversion is expected to cause a shift in species assemblages towards those found in rocky reef/rock outcrop

CONSTRUCTION AND OPERATIONS PLAN

Site Characterization and Assessment of Impacts – Biological Resources

habitat; this is known as the “reef effect” (Reubens et al. 2013; Wilhelmsson et al. 2006). This effect is also well known from other anthropogenic structures in the sea, such as oil platforms, artificial reefs piers, and shipwrecks (Claudet and Pelletier 2004; Langhamer and Wilhelmsson 2009; Seaman 2007; Wilhelmsson et al. 2006).

The specific changes to species assemblages are not entirely predictable. Several studies have documented succession of epifaunal colonization on wind turbine foundations and scour protection as well as the development of distinct vertical zonation of species distribution from intertidal to deep subtidal components of the WTG foundations (e.g., De Mesel et al. 2015; De Backer and Hostens 2017), as discussed further below. However, the extent of the reef effect would be relatively small, as the hard bottom habitat would extend only a few meters around each foundation, and the portion of the subsea IAC that would require armoring is up to 15 percent. The IAC would likely require targeted surface protection in areas of consolidated glacial moraine that are already hard bottom, which would not result in long-term habitat conversion. The area that would be converted from soft bottom to hard bottom represents a negligible fraction of the total soft bottom on the southern New England continental shelf. Given the highly localized and small spatial extent of the converted habitat, population-level effects on benthic or shellfish resources are not expected to be measurable. As the new infrastructure is converted to artificial reefs, impacts on benthic and shellfish resources would be both adverse and beneficial.

The use of gravel, boulders, and/or concrete mats will create new hard substrate that is expected to be initially colonized by barnacles, tube-forming species, hydroids, and other fouling species found on existing hard bottom habitat in the region. Foundations, scour protection, and cable protection typically have crevices that increase structural complexity of the area and attract finfish and invertebrate species seeking shelter, including crabs and American lobster. For example, Jonah crabs appear to be attracted to rocky habitats with crevices (NOAA Fisheries 2018), which would be increased in the areas immediately surrounding foundations. Lobster associate preferentially with boulders and transition zones around boulders (Collie and King 2016). An offshore wind farm in the United Kingdom reported initial aggregations of European lobster within a newly constructed wind farm; studies on long-term effects on lobster densities are ongoing (Roach et al. 2018).

Monopiles attract a range of attached epifauna and flora, including barnacles and filamentous algae (Petersen and Malm 2006). Jacket foundations are more complex structures than monopile foundations and may increase habitat complexity and provide more suitable fouling surfaces and increased protection from predators (MMS 2009). As these foundations extend from below the seafloor to above the surface of the water, the development of attached benthic fauna and flora zonation with depth is expected (De Mesel et al. 2015; De Backer and Hostens 2017). Macroalgal zonation may occur ranging from deeper growing red foliose algae and calcareous algae to kelps and other species more common in shallow environments. Other species that may benefit from the increased hard substrate, which will also exhibit zonation with depth, include sea anemones and other anthozoans, bivalves such as horse mussel and blue mussel, green sea urchin, barnacles, hydrozoans, sponges, and other fouling organisms.

CONSTRUCTION AND OPERATIONS PLAN

Site Characterization and Assessment of Impacts – Biological Resources

The foundations and scour protection are novel hard substrate habitats introduced to generally soft sediment areas. The increase in habitat heterogeneity and hard substrate may promote not only the growth of native epibenthic species, as discussed above, but also may potentially promote colonization by non-indigenous species and/or range-expanding species. The concept of offshore wind structures as “stepping stones” for these groups of species has been suggested and observed in other regions (as reviewed in Dannheim et al. 2019; e.g., De Mesel et al. 2015; Coolen et al. 2018). Non-indigenous species, including, although not limited to, crustaceans (e.g., the Asian shore crab (*Hemigrapsus sanguineus*), molluscs (e.g., *Crepidula fornicata*), and tunicates (e.g., *Didemnum vexillum*) have the potential to colonize the foundations in this region, as observed in other regions (e.g., Kerckhof et al. 2016). The effects of the colonization of these types of species on the community assemblage and ecosystem function varies depending on the particular species and its abundance. Additionally, epibenthic species from southern regions, such as the Mid-Atlantic, may utilize this novel habitat as their populations move northward as suitable environmental conditions shift northward in response to climatic drivers (i.e., range-expansion species).

Sediment Suspension and Deposition

Increases in sediment suspension and deposition during O&M will result from vessel anchoring and non-routine maintenance activities that require exposing the IAC. Impacts on benthic resources and shellfish resulting from sediment suspension and deposition during these activities are expected to be similar to those discussed for the construction phase, but on a more limited spatial scale.

Noise

Impacts on benthic and shellfish resources from vessel noise during O&M are expected to be similar to those discussed for construction, though lesser in extent. The noise generated by vessel will be similar to the range of noise from existing vessel traffic in the region and is not expected to substantially affect the existing underwater noise environment. The WTGs will produce low-level continuous underwater noise (infrasound) during operation. Low-frequency sounds, generally below 700 Hz, are produced when the blades are spinning, at source levels of 80 to 150 dB re 1 μ Pa (Kikuchi 2010; Betke et al. 2004). There are no conclusive studies on the impacts of WTG operational noise on benthic species. Noise levels from WTGs operation are not expected to result in injury or mortality of benthic or shellfish species.

Electric and Magnetic Fields

Once energized, the Project cables will produce a magnetic field and an induced electric field that will decrease in strength rapidly with distance. The IAC will be AC, shielded and, where feasible, buried beneath the seafloor or otherwise protected. Submarine transmission cables are sources of magnetic fields as well as induced electrical fields (Snyder et al. 2019). Exposure to EMF could be short- or long-term, depending on the mobility and behavior of the species/life stage (U.K. Department for Business Enterprise and Regulatory Reform 2008; Woodruff et al. 2012; Love et al. 2015, 2016).

CONSTRUCTION AND OPERATIONS PLAN

Site Characterization and Assessment of Impacts – Biological Resources

A modeling analysis of the magnetic fields and induced electric fields during operation of the IAC and OCS–DC was performed and results are included in Appendix J1. Appendix J1 also summarizes data from field studies conducted to assess impacts of EMF on marine organisms. These studies constitute the best source of evidence to assess the potential impacts on finfish and invertebrate behavior or distribution in the presence of energized cables. The modelling provides maximum magnetic and induced electric fields associated with specific components of the operation of SRWF including WTG and OCS–DC structures, the SRWEC, and the IAC. For the IAC, the modelled field levels were evaluated at 3.3 ft (1 m) above the seabed and at the seabed. As detailed in Appendix J1, where buried to a depth of 3.3 ft (1 m), the change in DC magnetic field from that of Earth's geomagnetic field will be 129 mG with induced electric fields (in an ocean current of 2 ft/sec [0.6 m/s]) of 0.33 mV/m. The AC magnetic fields and induced electric fields from operational IAC will decrease quickly with increasing distance. At a height of 3.3 ft (1 m) directly over the cables at peak loading, AC magnetic- and induced electric-field levels were calculated to be 4.5 mG and < 0.1 mV/m, decreasing to 1.1 mG and < 0.1 mV/m or less at a horizontal distance of ±10 ft (3 m) from the cables. Based on these modeling results and existing evidence, the EMF associated with the operation of the SRWF will be below the detection capability of most invertebrate species and are unlikely to result in measurable impacts on benthic invertebrate species or populations.

While certain fish and crustacean species are known to detect EMF (Taormina et al. 2018; Gill et al. 2014), the ability of soft-bodied benthic invertebrates to detect EMF is not as well understood. Modelled effects of EMF from the AC subsea cables at the Virginia Offshore Wind Technology Advancement Project site were found not to adversely affect benthic habitats (BOEM 2015). Electric and magnetic fields from subsea cables associated with the Block Island Wind Farm were determined to have no effect on sturgeon or their prey (NOAA Fisheries 2015). The finding that neither sturgeon nor their prey would be affected by EMF can be extrapolated to the dominant benthic species in the marine portions of the Project Area; the Atlantic sturgeon is a bottom feeder reported to prefer polychaetes and arthropods (Johnson et al. 1997). Based on field data from operational wind projects in Europe and the US Atlantic coast, and modeling results of potential effects of EMF on managed species, the IAC would have minimal direct long-term impact on benthic and shellfish resources.

Field surveys on the behavior of large crab species and lobster at submarine cable sites (Love et al. 2017; Hutchison et al. 2018) suggest that the Project's calculated magnetic-field levels (Appendix J1) are not likely to impact the distribution and movement of large epibenthic crustaceans. Ancillary data and observations from these field studies also suggest that cephalopod behavior is similarly unaffected by the presence of 60-Hz AC cables. Hutchison et al. (2018, 2020) assessed the responses of American lobster to an DC cable under field conditions and concluded that EMF resulted in small-scale changes in lobster distribution within the cages, although the cable was not observed to present a barrier to movement. In contrast, two marine crabs on the Pacific coast (Dungeness crab [*Metacarcinus magister*] and *Cancer productus*) were reported to be insensitive to EMF from energized subsea cables (Love et al. 2017). A synthesis paper on the current understanding of potential impacts of EMF on invertebrates concludes that while some studies have shown changes in individuals during laboratory studies, not enough information is available to determine how those changes may extend to the population or community level or ecological processes (Albert et al. 2020).

CONSTRUCTION AND OPERATIONS PLAN

Site Characterization and Assessment of Impacts – Biological Resources

Based on the modeling results and existing evidence, the EMF associated with the cables will be below the detection capability of most invertebrate species and are unlikely to result in measurable impacts on benthic invertebrate species.

Discharge and Releases

Impacts from accidental discharges and releases during O&M are expected to be similar to, but of lesser likelihood than during construction, as there will be fewer Project-related marine vessels during this phase, and regulatory requirements and preventative measures will still apply. Unpermitted discharges or releases are considered accidental events, and in their unlikely occurrence, these are expected to result in minimal, temporary impacts. Permitted discharges are not expected to pose an adverse impact to marine resources as they will quickly disperse, dilute, and biodegrade (BOEM 2013).

Seawater cooling will be needed for the OCS–DC (Section 3.3.6.1). During operation, the OCS–DC will require continuous cooling water withdrawals and subsequent discharge of heated effluent back to the receiving waters. The maximum DIF and discharge volume is 8.1 million gallons per day with actual intake flow (AIF) and discharge volumes that are dependent on ambient source water temperature and facility output. Preliminary hydrodynamic modelling indicates that there will be some highly localized increases in water temperature in the immediate vicinity of the discharge location of the OCS–DC. The design, configuration, and operation of the CWIS for the OCS–DC will be permitted as part of an individual NPDES permit and additional details will be included in the permit application submitted to the EPA. This will include final results of the hydrodynamic modelling.

Trash and Debris

Impacts from marine disposal of trash and debris during O&M are expected to be similar to, but of lesser likelihood than during construction, as there will be fewer Project-related marine vessels during this phase, and regulatory requirements and preventative measures will still apply. The unanticipated marine disposal of trash and debris is considered an unpermitted, accidental event, and containment and good housekeeping practices will be implemented to minimize the potential.

Decommissioning

At the end of the Project's operational life, Project structures will be decommissioned in accordance with a detailed Project decommissioning plan that will be developed in compliance with applicable laws, regulations, and BMPs at that time. All facilities will need to be removed to a depth of 15 ft (4.6 m) below the mudline, unless otherwise authorized by BOEM (30 CFR § 585.910(a)). This plan will account for changing circumstances during the operational phase of the Project and will reflect new discoveries particularly in the areas of marine environment, technological change, and any relevant amended legislation. Absent permission from BOEM, Sunrise Wind will complete decommissioning within two years of termination of the Lease.

CONSTRUCTION AND OPERATIONS PLAN

Site Characterization and Assessment of Impacts – Biological Resources

If the man-made structures are to be removed at the end of the Project's operational life, as currently prescribed, this will reverse the expected beneficial impacts on benthic and shellfish resources through the introduction of complex habitat. Over time, the disturbed area is expected to revert to pre-construction conditions, which would result in a beneficial impact for species and life stages that inhabit soft bottom habitats. Overall, habitat alteration from decommissioning is expected to cause minimal impacts because similar soft and hard bottom habitats are already present in and around the SRWF and SRWEC (Appendices M1, M2, and M3), and the conversion of a relatively small area of habitat is unlikely to result in substantial effects, as any effect observed will be limited to the immediate vicinity of the individual structures.

A recent review on the impacts of decommissioning man-made structures provides the case for considering alternatives to a mandated complete removal of all man-made structures. The paper emphasizes the potential importance of man-made submerged structures as complex habitats potentially supporting a rich localized food web (Fortune and Paterson 2020). Benthic habitat monitoring at the foundations and the surrounding seabed will document the direct realized effects of these novel hard surfaces on benthic and shellfish resources. Documenting the established epifaunal community that will inhabit the foundations, as well as the infaunal community at the base of these structures, will provide information on the habitat value, including its value as refuge and food source for other marine species. The data gathered from these post-construction benthic surveys will be used to inform decommissioning strategies in the future.

Sunrise Wind Export Cable–OCS

Construction

Seafloor Disturbance

Seafloor disturbance and habitat alteration impacts associated with SRWEC–OCS construction will be similar to those described for the construction of the SRWF. Construction of the SRWEC will involve seafloor preparation activities, including boulder relocation and sand wave leveling, SRWEC installation, installation of cable protection along portions of the SRWEC–OCS, and vessel anchoring (including spuds). These activities will cause seafloor disturbance and habitat alteration. The expected impacts of these activities on benthic and shellfish resources are similar to those discussed for the construction phase of the SRWF. Seafloor-disturbing activities could cause injury or mortality to benthic species and negatively affect their habitats. The impacts associated with these activities will be short-term, ceasing after the construction is complete in a given area. Seafloor disturbance and habitat alteration will encompass a small area of similar available benthic habitat in the region.

The SRWEC–OCS will be sited to avoid and minimize impacts to sensitive habitats (e.g., hard bottom habitats) to the extent practicable. The SRWEC–OCS will typically target a burial depth of 3 to 7 ft (1 to 2 m). The target burial depth will be determined based on an assessment of seabed conditions, seabed mobility, the risk of interaction with external hazards such as fishing gear and vessel anchors, and a site-specific Cable Burial Risk Assessment. The effects on proposed changes to the physical and biological processes of benthic and shellfish resources are expected to be similar, regardless of the specific burial depth between 3 to 7 ft (1 to 2 m).

CONSTRUCTION AND OPERATIONS PLAN

Site Characterization and Assessment of Impacts – Biological Resources

For example, whether the cable is buried 3 or 7 ft (1 to 2 m), the sessile and slow-moving benthic organisms within the vicinity of the cable installation activity are expected to experience mortality because benthic organisms live only within the first 8 to 10 in (20 to 25 cm) of the sediment column. Deeper burial depth may, however, result in larger volumes of sediment resuspension and subsequent deposition. That is because deeper burial depths would require the physical disturbance of more sediment volume below the surface.

As discussed for the construction of the SRWF, the potential impacts on benthic resources and shellfish from seafloor disturbance due to seafloor preparation and vessel anchoring for the SRWEC–OCS primarily affect the species and life stages that prefer the types of habitats that will be disturbed, and specifically sessile or slow-moving organisms that are unable to move away from the disturbance. Cable installation activities are expected to result in similar direct impacts on benthic and shellfish resources as seafloor preparation. The potential impacts from these activities will be short-term, as seafloor disturbance stops when the activities cease. However, the presence of cable protection along portions of the SRWEC–OCS will result in long-term impacts on benthic species as detailed in the O&M section.

As discussed for the construction of the SRWF, in areas of sediment disturbance benthic habitat recovery and benthic infaunal and epifaunal species abundances may take up to one to three years to recover to pre-impact levels (e.g., INSPIRE 2016; AKRF, Inc. et al. 2012; Germano et al. 1994; Hirsch et al. 1978; Kenny and Rees 1994). Recolonization rates of benthic habitats are driven by the benthic communities inhabiting the area surrounding the affected region. Communities well-adapted to disturbance within their habitats (e.g., sand sheets) are expected to quickly recolonize a disturbed area, while communities not well adapted to frequent disturbance (e.g., cobble and boulder habitats) will take longer to recolonize. Mobile species may also be indirectly affected by the temporary reduction of benthic forage species, but these impacts are expected to be minor given the availability of similar habitats in the area.

Sediment Suspension and Deposition

Seafloor-disturbing activities associated with the SRWEC–OCS installation will result in temporary increases in sediment suspension and deposition, similar to construction of the SRWF discussed above. Sediment transport modeling for the Project was performed using the PTM to evaluate the concentrations of suspended sediments, spatial extent, and duration of sediment plumes, and the seafloor deposition resulting from construction activities. The sediment transport modeling results are summarized in Table 4.4.2-2. The model, inputs, and results are described in detail in Appendix H.

For the SRWEC–OCS, modeling results indicate that during jet plow sediment plumes with TSS concentrations exceeding the ambient conditions by 100 mg/L could extend up to 2,969 ft (905 m) from the cable corridor centerline in federal waters. The model estimated that the elevated TSS concentrations would be of short duration and expected to return to ambient conditions within 0.4 hours following the cessation of cable burial activities. Sedimentation from SRWEC–OCS burial is predicted to exceed 0.4 in (10 mm) of deposition up to 791 ft (241 m) from the cable corridor centerline. This thickness of sedimentation is expected to cover approximately 832.3 acres (337 ha) in federal waters, and the TSS plume is predicted to be primarily contained within the lower portion of the water column, approximately 9.8 ft (3.0 m) above the seafloor.

CONSTRUCTION AND OPERATIONS PLAN

Site Characterization and Assessment of Impacts – Biological Resources

or sand wave leveling associated with SRWEC–OCS construction, modeling results indicate that sediment plumes with TSS concentrations exceeding ambient conditions by 100 mg/L could extend up to 5,052 ft (1,540 m) from the cable corridor centerline in federal waters (trailing suction hopper dredge with bulk disposal scenario). The model estimated that the elevated TSS concentrations from sand wave leveling would be of short duration and expected to return to ambient conditions within up to 0.4 hours following the cessation of sand wave leveling activities in federal waters. Sedimentation from sand wave leveling along the SRWEC–OCS is predicted to exceed 0.4 in (10 mm) of deposition up to 1,427 ft (435 m) from the activity (CFE sand wave leveling scenario). This thickness of sedimentation is expected to cover approximately 174.2 acres (0.70 km²) in federal waters.

Direct impacts on benthic resources and shellfish from sediment suspension and deposition are expected to be similar to those discussed for construction of the SRWF, with greater impacts on sessile and slow-moving benthic species compared to mobile species. Also, sediment deposition is expected to have greater impacts on hard bottom communities compared to soft bottom communities, which are more habituated to frequent sediment redistribution.

Noise

The direct impacts on benthic resources and shellfish from noise associated with vessels and construction equipment during construction of the SRWEC–OCS are expected to be similar to those discussed for the construction phase of the SRWF.

Discharges and Releases

Impacts associated with discharges and releases during construction of the SRWEC–OCS are expected to be similar to those identified for the SRWF.

Trash and Debris

Impacts associated with marine trash and debris during construction of the SRWEC–OCS are expected to be similar to the impacts of marine trash and debris discussed for construction of the SRWF. With proper waste management procedures, the potential for trash or debris to be inadvertently left overboard or introduced into the marine environment is not anticipated.

Operations and Maintenance

Seafloor Disturbance

Minimal impacts on benthic resources and shellfish are expected from operation of the SRWEC–OCS as it will be buried beneath the seabed. Seafloor disturbance during O&M of the SRWEC–OCS is only expected during non-routine maintenance that may require uncovering and reburial of the cables, as well as maintenance of cable protection. These maintenance activities and associated vessel anchoring are expected to result in similar impacts on benthic and shellfish resources as those discussed for the IAC at the SRWF, although the extent of disturbance would be limited to specific areas along the SRWEC–OCS corridor.

CONSTRUCTION AND OPERATIONS PLAN

Site Characterization and Assessment of Impacts – Biological Resources

Cable protection (e.g., concrete mattresses or rock berms) may be placed in select areas along the SRWEC–OCS. The introduction of engineered concrete mattresses or rock to areas of the seafloor can cause local disruptions to circulation, currents, and natural sediment transport patterns. Under normal circumstances these segments of the SRWEC–OCS are expected to remain covered by sediment and associated cable protection (where applicable). In non-routine situations, these segments may be uncovered and reburial might be required. The protection of the cable with concrete mattresses or rock berms may result in the long-term conversion of soft bottom habitat to hard bottom habitat. Similar to the SRWF foundations, the cable protection may have a long-term impact on species associated with soft bottom habitats and a long-term beneficial effect on species associated with hard bottom habitats, depending on the quality of the habitat created by the cable protection, and the composition of the benthic community that colonizes that habitat. More details are discussed in the section describing the O&M of the SRWF impacts.

Sediment Suspension and Deposition

Increases in sediment suspension and deposition during the O&M phase may result from vessel anchoring and non-routine maintenance activities that require exposing portions of the SRWEC–OCS. This is expected to have similar impacts on benthic and shellfish resources to those discussed for the construction phase of the SRWF, but on a more limited spatial scale. Sessile species and organisms with limited mobility are more likely to be affected by these activities than mobile species.

Noise

Impacts on benthic resources and shellfish from vessel noise during O&M of the SRWEC–OCS are expected to be similar to those discussed for the construction phase of the SRWF, though lesser in extent.

Electric and Magnetic Fields

Once the SRWEC–OCS becomes energized, the cables will produce a magnetic field that will decrease in strength rapidly with distance. The cable will be shielded and buried beneath the seafloor. Submarine transmission cables do not directly emit electrical fields into surrounding areas but are surrounded by magnetic fields that can cause induced electrical fields in moving water (Gill et al. 2012). Exposure to EMF could be short- or long-term, depending on the mobility of the species (U.K. Department for Business Enterprise and Regulatory Reform 2008; Woodruff et al. 2012; Love et al. 2015, 2016).

A modeling analysis of the magnetic fields and induced electric fields anticipated to be produced during operation of the SRWEC–OCS was performed and results are included in Appendix J1. Appendix J1 also summarizes data from field studies conducted to assess impacts of EMF on marine organisms. These studies constitute the best source of evidence to assess the potential impacts on benthic organismal behavior or distribution in the presence of energized cables. The modelling provides maximum magnetic and induced electric fields associated with the SRWEC–OCS. Based on the modeling results and existing evidence, the EMF associated with the cables will be below the detection capability of most invertebrate species and are unlikely to result in measurable impacts on benthic invertebrate species.

CONSTRUCTION AND OPERATIONS PLAN

Site Characterization and Assessment of Impacts – Biological Resources

As detailed in Appendix J1, the DC magnetic fields have a height of 3.3 ft (1 m) above the SRWEC–OCS at peak loading (assessed for all permutations of four geographic directions and four cable configurations) were calculated to change Earth's ambient geomagnetic field by a maximum of ± 129 mG, decreasing to ± 41 mG a horizontal distance of 10 ft (3 m) from the cables, representing a change of less than 10 percent of the ambient geomagnetic field level of approximately 506 mG. Induced DC electric fields in an ocean current of 2 ft/s (60 cm/s) are dominated by the effects of Earth's ambient geomagnetic field and were calculated to be 0.38 mV/m directly above the SRWEC–OCS, decreasing to 0.033 mV/m at a distance of ± 10 ft (3 m).

There are mixed results on the effects of static magnetic field sourced from cables on invertebrates. Crustacean, echinoderm, and polychaete species were found to not have a clear response to static magnetic fields of 27,000 mG (Bochert and Zettler 2004). Dungeness crab exposed to 10,000 mG DC magnetic fields were more likely to exhibit changes in activity, spending less time buried in sand (Woodruff 2013). Juvenile European lobster were unaffected by exposure to artificial static magnetic fields up to 2,300 mG (Taormina et al. 2020).

Crabs (*Cancer pagurus*) were more likely to inhabit shelter and reduce foraging time during exposure to static magnetic fields (28,000 to 400,000 mG) (Scott et al. 2018). Caged American lobster exposed to DC cables producing a total magnetic field of 653 mG had some behavioral response resulting in changes in the distribution of the lobsters in the cages although the cable was not observed to be a barrier to movement (Hutchison et al. 2018, 2020). Thus, the modeled magnetic-field strength at peak loading from DC cable (989 mG) is near the lower end of where documented effects were observed. Detection is possible but not likely to induce population level changes.

Behavioral effects and/or changes in species abundance and distributions due to EMF associated with operation of the SRWEC–OCS are not expected. These conclusions are consistent with the findings of a previous comprehensive review of the ecological impacts of marine renewable energy projects, where it was determined that there has been no evidence demonstrating that EMF at the levels expected from marine renewable energy projects will cause an effect (negative or positive) on any species (Copping et al. 2016).

Discharges and Releases

Impacts associated with discharges and releases during O&M of the SRWEC–OCS are expected to be similar to, but of lesser likelihood than during construction of the SRWF, as there will be fewer Project-related marine vessels during this phase, and regulatory requirements and preventative measures will still apply.

Trash and Debris

Impacts associated with marine trash and debris are expected to be similar to, but of lesser likelihood than during construction, as there will be fewer Project-related marine vessels during this phase, and regulatory requirements and preventative measures will still apply.

CONSTRUCTION AND OPERATIONS PLAN

Site Characterization and Assessment of Impacts – Biological Resources

Sunrise Wind Export Cable–NYS

Construction

Seafloor Disturbance

Seafloor disturbance and habitat alteration are expected to occur as a result of seafloor preparation, cable installation, and vessel anchoring during the construction of the SRWEC–NYS.

Direct impacts on benthic resources and shellfish from seafloor preparation, including boulder removal and sand wave leveling, and vessel anchoring for the SRWEC–NYS are expected to be similar to those discussed for the construction of the SRWEC–OCS. However, as the SRWEC–NYS nears landfall, shallower areas will be affected compared to the SRWEC–OCS. These shallower areas have slightly different species assemblages than the deeper offshore areas (see Appendix M1 for details on the specific species that occur in these areas).

The SRWEC–NYS installation activities are expected to result in direct impacts on benthic resources and shellfish similar to those associated with seafloor preparation. Cable protection along portions of the SRWEC–NYS are expected to result in long-term impacts on benthic resources and shellfish as discussed in the SRWEC–NYS O&M section.

Construction of the SRWEC–NYS Landfall would be accomplished with HDD methodology. HDD installation would involve the excavation of HDD exit pits offshore within the surveyed corridor. Depending on the cable specifications and the seafloor characteristics, these exit pits (a total of three) will be a maximum of 164 ft x 49 ft x 16 ft (50 m x 15 m x 5 m) (length x width x depth). This activity could cause injury or mortality to benthic species, particularly infauna, immobile, or slow-moving species in the direct vicinity of the excavation, and negatively affect their habitats. The impacts associated with this activity will be short-term, ceasing after the construction is complete in a given area. Seafloor disturbance from HDD exit pit excavation will encompass a small area of similar available benthic habitat in the region (see Table 3.3.3-3), with dredged material being placed either within the vessel and disposed of on-site or at an appropriate disposal site. Alternatively, the dredged material may be placed beside the trench and used after cable lay for backfilling. Specific details on provisions for handling excavated materials will be provided in the Project EM&CP.

As discussed for the construction of the SRWEC–OCS, in areas of sediment disturbance, benthic habitat recovery and benthic infaunal and epifaunal species abundances may take up to one to three years to recover to pre-impact levels (e.g., INSPIRE 2016; AKRF, Inc. et al. 2012; Germano et al. 1994; Hirsch et al. 1978; Kenny and Rees 1994). As such, this direct impact is expected to be long-term but minor for both mobile and sessile species and life stages. Mobile species may also be indirectly affected by the temporary reduction of benthic forage species, but these impacts are expected to be minor given the high availability of similar habitats in the area.

CONSTRUCTION AND OPERATIONS PLAN

Site Characterization and Assessment of Impacts – Biological Resources

Sediment Suspension and Deposition

Seafloor-disturbing activities associated with SRWEC–NYS installation will result in temporary increases in sediment suspension and deposition, as discussed for the construction of the SRWEC–OCS. Sediment transport modeling for the Project was performed by using the PTM to evaluate the concentrations of suspended sediments, spatial extent and duration of sediment plumes, and the seafloor deposition resulting from construction activities. The sediment transport modeling results are summarized in Table 4.4.2-2. The model, inputs, and results are described in detail in Appendix H.

For the SRWEC–NYS, cable burial by jet plow, modeling results indicate that sediment plumes with TSS concentrations are not expected to exceed the ambient conditions by 100 mg/L in NYS waters. The model estimated that the elevated TSS concentrations would be of short duration and expected to return to ambient conditions within 0.3 hours following the cessation of cable burial activities. Sedimentation from SRWEC–NYS burial is predicted to exceed 0.4 in (10 mm) of deposition up to 253 ft (77 m) from the cable corridor centerline. This thickness of sedimentation is expected to cover approximately 53.1 acres (21.5 ha) in state waters, and the TSS plume was predicted to be primarily contained within the lower portion of the water column, approximately 8.5 ft (2.5 m) above the seafloor. Mechanical dredging of HDD exit pits is not expected to elevate TSS concentrations more than 100 mg/L above ambient conditions, and TSS concentrations are expected to return to ambient within 0.3 hours. Sedimentation from HDD exit pit dredging may exceed 0.4 in (10 mm) of deposition up to 79 ft (24 m) from the pit and cover approximately 0.25 acres (1,012 m²).

For sand wave leveling associated with SRWEC–NYS construction, modeling results indicate that sediment plumes with TSS concentrations exceeding ambient conditions by 100 mg/L could extend up to 6,775 ft (2,065 m) from the cable corridor centerline in NYS waters (trailing suction hopper dredge with hydraulic disposal scenario). The model estimated that the elevated TSS concentrations from sand wave leveling would be of short duration and expected to return to ambient conditions within up to 0.5 hours following the cessation of sand wave leveling activities in NYS waters. Sedimentation from sand wave leveling along the SRWEC–NYS is predicted to exceed 0.4 in (10 mm) of deposition up to 2,903 ft (885 m) from the activity (trailing suction hopper dredge with hydraulic disposal scenario). This thickness of sedimentation is expected to cover approximately 75.6 acres (0.31 km²) in NYS waters.

Similar to the impacts discussed for the construction of the SRWEC–OCS, direct impacts on benthic and shellfish resources from sediment suspension and deposition associated with construction of the SRWEC–NYS are expected to be similar to those discussed for construction of the SRWF, with greater impacts on sessile and slow-moving benthic species/life stages compared to mobile and pelagic species/life stages. In shallow waters, TSS plumes from construction activities may occupy the majority of the water column, and mobile species/life stages may temporarily vacate the area of disturbance.

Noise

Direct impacts on benthic resources and shellfish resulting from vessel and construction equipment noise, which are continuous and non-impulsive, are expected to be similar to those discussed for construction of the SRWEC–OCS.

CONSTRUCTION AND OPERATIONS PLAN

Site Characterization and Assessment of Impacts – Biological Resources

Discharges and Releases

Impacts associated with potential discharges and releases during construction of the SRWEC–NYS are expected to be similar to those discussed for construction of the SRWF. Additionally, HDD at Landfall will use a drilling fluid that consists of bentonite, drilling additives, and water. A barge or jack-up vessel may also be used to assist the drilling process, handle the pipe for pull in, and help transport the drilling fluids and mud for treatment, disposal, and/or reuse. To minimize the potential risks for an inadvertent drilling fluid release, an Inadvertent Return Plan will be developed and implemented during construction. Refer to Section 3.3.3.3 for additional details regarding HDD installation and the use of drilling fluids.

Trash and Debris

Impacts associated with marine trash and debris during construction of the SRWEC–NYS are expected to be similar to the impacts of marine trash and debris discussed for construction of the SRWF. With proper waste management procedures, the potential for trash or debris to be inadvertently left overboard or introduced into the marine environment is not anticipated.

Operations and Maintenance

Seafloor Disturbance

Minimal impacts from seafloor disturbance on benthic resources and shellfish are expected from the O&M of the SRWEC–NYS, as it will be buried beneath the seabed. As discussed for the SRWEC–OCS, seafloor disturbance during O&M of the SRWEC will only occur during non-routine maintenance that may require uncovering and reburial of the cables, as well as maintenance of cable protection. These maintenance activities and associated vessel anchoring are expected to result in similar impacts on benthic and shellfish resources as those discussed for the maintenance of the SRWEC–OCS.

Direct impacts on benthic resources and shellfish associated with O&M activities for the SRWEC–NYS are expected to result in similar impacts as those discussed for the IAC and SRWEC–OCS, but will be more limited in spatial extent. The seafloor overlaying the majority of buried SRWEC–NYS, where cable protection will not exist, is expected to return to pre-construction conditions over time and no long-term changes to sediment mobility and depositional patterns are expected. However, as discussed for the SRWEC–OCS, cable protection (e.g., concrete mattresses or rock berms) may be placed in select areas along the SRWEC–NYS, which is expected to result in long-term conversion of soft sediment habitat to more complex, hard bottom habitat. Similar to the SRWF foundations, the protection of the cable with concrete mattresses or rock berms may directly impact species associated with soft bottom habitats by displacing them. Cable protection is expected to result in long-term beneficial effects for species associated with hard bottom habitats, depending on the quality of the habitat created by the cable protection and the quality of the benthic community that colonizes that habitat.

CONSTRUCTION AND OPERATIONS PLAN

Site Characterization and Assessment of Impacts – Biological Resources

Sediment Suspension and Deposition

Increases in sediment suspension and deposition during the O&M phase may result from vessel anchoring and non-routine maintenance activities that require exposing portions of the SRWEC–NYS. Increases in sediment suspension and deposition will impact sessile and slow-moving species more than mobile species. These impacts will be similar to those discussed for the construction phase, but on a more limited spatial scale.

Noise

Impacts on benthic resources and shellfish from vessel noise during O&M of the SRWEC–NYS are expected to be similar to those discussed for the construction phase, though lesser in extent.

Electric and Magnetic Fields

As discussed for the SRWEC–OCS, a modeling analysis of the magnetic fields and induced electric fields anticipated to be produced during operation of the IAC and SRWEC was performed and results are included in Appendix J1. Behavioral effects and/or changes in species abundance and distributions due to EMF associated with the SRWEC–NYS are not expected, see discussion under O&M for the SRWEC–OCS.

Discharges and Releases

Impacts associated with potential discharges and releases during O&M of the SRWEC–NYS are expected to be similar to, but of lesser likelihood than during construction, as there will be fewer Project-related marine vessels during this phase, and regulatory requirements and preventative measures will still apply.

Trash and Debris

Impacts from disposal of trash and debris during O&M are expected to be similar to, but of lesser likelihood than during construction, as there will be fewer Project-related marine vessels during this phase, and regulatory requirements and preventative measures will still apply.

Onshore Facilities

Construction

Seafloor Disturbance

The temporary floating pier that may be deployed to aid in the transport of equipment and materials for the Landfall HDD and ICW HDD (Section 3.3.10.2) may temporarily impact the benthic and shellfish resources in its direct vicinity. The sessile and slow-moving benthic organisms inhabiting the sediments below where the floating pier (1,500 sq ft) may be installed at the Smith Point County Park may be crushed by the spuds from the barge and/or, at low tide, when the pier may be temporarily grounded, which may lead to injury or mortality. The sediments in the vicinity of the planned location of the temporary floating pier are expected to range from very fine sand to small gravels. As such, the sessile and slow-moving benthic organisms in this vicinity are likely to include infaunal polychaetes, tube-building amphipods, infaunal bivalves, epifaunal barnacles, and/or blue mussels, as well as attached macroalgae. Given the shallow depths and relatively low hydrodynamics, the benthic environment in this area may be suitable for SAV. The temporary floating pier may crush SAV if it exists directly below the structure when it

CONSTRUCTION AND OPERATIONS PLAN

Site Characterization and Assessment of Impacts – Biological Resources

becomes grounded. The temporary floating pier may also shade the sediments in its vicinity, reducing the photosynthetically active radiation available for SAV. However, the pier will be microsituated to avoid SAV to the extent practicable and the time of year when the proposed temporary floating pier is planned will likely occur after the seasonal SAV senesce (late fall) and prior to when the SAV begin germinating (early spring), and thus will minimize impacts.

Discharges and Releases

Although no impacts from discharges and releases are anticipated, spills or accidental releases of fuels, lubricants, or hydraulic fluids could occur during use of trenchless installation and duct bank installation methods, installation of the Onshore Transmission Cable or Onshore Interconnection Cable, or during construction activities at the OnCS–DC. An SPCC Plan will be developed and any discharges or release will be governed by NYS regulations. Additionally, where HDD is utilized, an Inadvertent Return Plan will be prepared and implemented to minimize the potential risks associated with release of drilling fluids. Any unanticipated discharges or releases within the Onshore Facilities during construction are expected to result in minimal, temporary impacts; activities are heavily regulated, and discharges and releases are considered accidental events that are unlikely to occur.

Construction of the Onshore Transmission Cable will be accomplished using HDD methodology where the proposed route crosses the ICW. As such, impacts to the inshore bivalve restoration projects are not expected. An inadvertent release of drilling fluid along the HDD segment could cause a temporary turbidity plume; however, bentonite clay particles would be expected to settle quickly due to the natural flocculation of clay particles in seawater. Although bentonite is non-toxic, it is a fine particulate material that could become entrained in the water column and transported to other locations if sufficient current velocities were present, causing turbidity and sedimentation.

The bivalve restoration projects in Bellport Bay include an area located at the mouth of the Carmans River, approximately 8,008 ft (2,441 m) northwest of the cable crossing area, where hard clams were stocked, while the other area is west of the Bellport Bay Yacht Club approximately 17,911 feet (5,459 m) west of the cable crossing area, which received oysters (Figure 4.4.2-2). If exposed to suspended bentonite, hard clams are likely to reduce filtration rates until concentrations of suspended solids decrease. Oysters are more likely to produce greater amounts of pseudofeces under conditions of high suspended sediments in the water column. A study reported no hard clam mortality when exposed to repeated exposure to suspended fine clays and subsequent sedimentation (Archambault et al. 2004). Another study found 7 percent and 60 percent mortality of adult sea scallops under prolonged exposure to bentonite clay at concentrations of 2 mg/L and 10 mg/L, respectively (Cranford and Gordon 1992). As mentioned elsewhere an Inadvertent Return Plan will be implemented to minimize the potential risks associated with drilling fluids.

CONSTRUCTION AND OPERATIONS PLAN

Site Characterization and Assessment of Impacts – Biological Resources

Operations and Maintenance

Potential impacts to benthic and shellfish resources from EMF during O&M of the Onshore Facilities are expected to be similar to those previously described for the SRWEC–NYS. Based on modeling results (provided in Appendix J1), EMF associated with O&M will be below the detection capability of most invertebrate species. Additionally, the footprint of the subsea cable within the ICW is quite small when compared to the waterway as a whole. Based on the fact that behavioral responses to magnetic fields are not expected along cables, changes in species abundance and distributions due to EMF are not expected to occur. Owing to the cable burial depths, no maintenance is anticipated along the HDD segments for the Onshore Facilities, and work would be limited to the existing vault locations.

4.4.2.3 Proposed Environmental Protection Measures

Sunrise Wind will implement the following environmental protection measures to reduce potential impacts on benthic and shellfish resources. These measures are based on protocols and procedures successfully implemented for similar offshore projects.

- Sunrise Wind is committed to collaborative science with the commercial and recreational fishing industries prior to, during, and following construction. Fisheries monitoring studies are being planned to assess the impacts associated with the Project on economically and ecologically important fisheries resources within the SRWF, along the SRWEC, and in the ICW. These studies will be conducted in collaboration with the local fishing industry and will build upon monitoring efforts being conducted by affiliates of Sunrise Wind at other wind farms in the region.
- The SRWF and SRWEC will be sited to avoid and minimize impacts to sensitive habitats (e.g., hard bottom habitats) to the extent practicable.
- To the extent feasible, the SRWEC and IAC will typically target a burial depth of 3 to 7 ft (1 to 2 m). The target burial depth will be determined based on an assessment of seabed conditions, seabed mobility, the risk of interaction with external hazards such as fishing gear and vessel anchors, and a site-specific Cable Burial Risk Assessment. The SRWEC Landfall will be installed via HDD to avoid impacts to the nearshore zones and benthic resources. The Onshore Transmission Cable will also be installed via HDD under the ICW to avoid impacts to benthic resources; HDD and trenchless methods will also be used elsewhere onshore, where appropriate, to minimize impacts to resource areas.
- To the extent feasible, installation of the IAC and SRWEC will be buried using equipment such as mechanical plow, jet plow, and/or mechanical cutter. These equipment options would result in less habitat modification than dredging options. The feasibility of cable burial equipment will be determined based on an assessment of seabed conditions and the Cable Burial Risk Assessment.
- DP vessels will be used for installation of the IAC and SRWEC to the extent practicable. DP vessels minimize seafloor impacts, as compared to use of a vessel relying on multiple anchors.
- A plan for vessels will be developed prior to construction to identify no-anchorage areas to avoid documented sensitive resources.

CONSTRUCTION AND OPERATIONS PLAN

Site Characterization and Assessment of Impacts – Biological Resources

- Sunrise Wind will require all construction and O&M vessels to comply with applicable International Convention for the Prevention of Pollution from Ships (IMO MARPOL), federal (USCG and EPA), and state regulations and standards for the management, treatment, discharge, and disposal of onboard solid and liquid wastes and the prevention and control of spills and discharges. Accidental spill or release of oils or other hazardous materials will be managed offshore through an ERP/OSRP and onshore through an SPCC Plan.

4.4.3 Finfish and Essential Fish Habitat

This section describes the affected environment and potential effects from the construction and operation of marine components of the Project as they relate to finfish and EFH. Finfish evaluated include pelagic, demersal, and anadromous fish that inhabit the region. EFH is defined in the MSFCMA (50 CFR Part 600) as those waters (i.e., aquatic areas and their associated physical, chemical, and biological properties used by fish) and substrate (i.e., sediment, hard bottom, underlying structures, and associated biological communities) necessary for the spawning, feeding, or growth to maturity of managed fish species. The role of benthic habitat as a resource for fisheries is reflected in the emphasis on EFH in BOEM's *Guidelines for Providing Benthic Habitat Survey Information for Renewable Energy Development on the Atlantic Outer Continental Shelf* pursuant to 30 CFR Part 585 (BOEM 2019). For this reason, this section is closely aligned with Section 4.4.2 (Benthic and Shellfish Resources), which discusses benthic invertebrates, squid, and benthic habitat resources associated with the Project. It is also supported by Appendix M1, Appendix M2, and Appendix N. Impacts of the Project on the socioeconomic value of managed species are discussed in Section 4.7.4.

A 0.5-mi (800-m) wide corridor around the SRWEC–OCS and SRWEC–NYS centerline was used for identifying species with EFH within the vicinity of the proposed cable route. The Onshore Transmission Cable route crosses under the ICW via HDD between Bellport Bay and Narrow Bay, just west of the Smith Point Bridge, then crosses under the Carmans River, also via HDD. EFH is designated within the portion of the Carmans River that experiences tidal influences; however, the Onshore Transmission Cable will cross Carmans River in an area that is designated as freshwater, and thus does not have designated EFH. Minimal impacts to this waterbody is expected from construction or operation of the Onshore Transmission Cable, as the cable will be buried and installed via HDD. Without finer resolution data, species with EFH descriptions that include Great South Bay, or species with mapped EFH in Great South Bay that have EFH text descriptions including shallow water environments, embayments, or estuaries, were identified as potentially having EFH along the Onshore Transmission Cable route. The description of the affected environment and assessment of potential impacts on finfish and EFH were developed by reviewing current public data sources related to finfish and EFH, including state and federal agency-published papers and databases; online data portals and mapping databases (e.g., NOAA Fisheries EFH Mapper, Northeast Ocean Data Portal, Mid-Atlantic Ocean Data Portal); environmental studies; published scientific literature relating to relevant EFH studies or designations; and correspondence and consultation with federal and state agencies.

CONSTRUCTION AND OPERATIONS PLAN

Site Characterization and Assessment of Impacts – Biological Resources

Fish species of interest in the Project Area are managed within a framework of overlapping international, federal, NYS, interstate, and tribal authorities. The New England Fishery Management Council (NEFMC) and Mid-Atlantic Fishery Management Council (MAFMC) share authority with NOAA Fisheries to manage and conserve fisheries in federal waters. Together they maintain Fishery Management Plans (FMPs) for specific species or species groups to regulate commercial and recreational fishing and define EFH within their geographic regions. NOAA Fisheries' Highly Migratory Species Division is responsible for the management of tunas, sharks, swordfish, and billfish in the Project Area. Within state waters associated with the Project Area, commercial and recreational fisheries are further managed by several state regulatory agencies, including the Atlantic States Marine Fisheries Commission (ASMFC), as well as ocean management plans of various types. Additionally, unmanaged forage species such as anchovies, silversides, and sand lances may be found throughout state and federal waters within the Project Area. Many of these species have not been assessed and abundance of most forage species varies annually based on environmental factors independent of the stock biomass (MAFMC 2017).

The following sections characterize demersal and pelagic life stages of finfish and EFH resources that may be present in the Project Area. Tables identifying economically and ecologically important finfish species, common habitat types, prey species, and EFH designations are presented at the conclusion of Section 4.4.3.1. This is followed by an assessment of the impact-producing factors to which finfish and EFH resources may be exposed, and a summary of environmental protection measures that Sunrise Wind will implement to avoid, minimize, and mitigate potential impacts to these resources. An EFH Assessment for designated species in the Project Area is provided as Appendix N.

4.4.3.1 Affected Environment

Regional Overview

The regional waters off the coast of Massachusetts and Rhode Island are transitional waters that separate Long Island Sound and Narragansett Bay from the OCS (BOEM 2013). These waters straddle the New England and Mid-Atlantic regions and serve as the southern boundary for some New England species and the northern boundary for some Mid-Atlantic species. The species that may be found in the SRWF and along the SRWEC reflect the transitional nature of this regional area.

The coastal waters of southern New England have diverse habitats that are defined by their temperature, salinity, pH, physical structure, biotic structure, depth, and currents. The unique combination of habitat characteristics shapes the community of fish and invertebrate species that inhabit the area. Habitat characteristics determine species composition, distribution, and predator/prey dynamics. Each habitat type supports a community of fish and invertebrate species that rely on the habitat to survive. Multiple factors directly affect spatial and temporal patterns of fish species. Major benthic habitat types expected to be found within the SRWF and along the SRWEC are described in Section 4.4.2.

In the Northeast region, NOAA Fisheries and the regional management councils have identified subsets of EFH as Habitat Areas of Particular Concern (HAPCs). These are habitat types and/or geographic areas identified by regional fishery management councils and NOAA Fisheries as priorities for habitat conservation, management, and research; however, the HAPC designation does not confer any specific habitat protection (MAFMC 2016).

CONSTRUCTION AND OPERATIONS PLAN

Site Characterization and Assessment of Impacts – Biological Resources

The councils identify HAPCs based on one or more of the following considerations: (1) the importance of the ecological function provided by the habitat, (2) the extent to which the habitat is sensitive to human-induced environmental degradation, (3) whether, and to what extent, development activities are, or will be, stressing the habitat type, and (4) the rarity of the habitat type (MAFMC 2016). Summer flounder is the only species with designated HAPC in the Project Area (specifically in Great South Bay). The MAFMC has identified HAPC for summer flounder as “All native species of macroalgae, seagrasses, and freshwater and tidal macrophytes in any size bed, as well as loose aggregations, within adult and juvenile summer flounder EFH” (MAFMC 2016). Discussion related to summer flounder HAPC can be found in Appendix N. HAPC for juvenile Atlantic cod occurs between the mean high-water line and a depth of 66 ft (20 m) in rocky habitats, in SAV, or in sandy habitats adjacent to rocky and SAV habitats for foraging from Maine through Rhode Island (NEFMC 2017). While HAPC for juvenile Atlantic cod can be found in the region, it does not occur within the footprint of the SRWF or SRWEC, nor in its immediate vicinity.

As summarized in BOEM's *Revised Environmental Assessment* (BOEM 2013), finfish off the coasts of New York, Massachusetts, and Rhode Island include sharks, demersal, and pelagic finfish assemblages. In addition, there are important shellfish (Section 4.4.2), anadromous species, and highly migratory pelagic finfish throughout the region. Demersal species (groundfish) spend at least part of their adult life stage on or close to the ocean bottom. Many groundfish species support high value fisheries and are sought by both commercial fishermen and recreational anglers. Pelagic fish are generally schooling fish that occupy the mid- to upper water column as juveniles and adults and are distributed from the nearshore to the continental slope and beyond. Highly migratory species are reported to be present in the near-coastal and shelf surface waters of Southern New England in the summer, taking advantage of the abundant prey in the warm surface waters. Coastal migratory pelagics include fast-swimming schooling fish that range from shore to the continental shelf edge and are sought by both recreational and commercial fishermen. These fish use the highly productive coastal waters of the more expansive Mid-Atlantic Bight during the summer months and migrate to deeper and/or distant waters during the remainder of the year (BOEM 2013). Pelagic sharks, large coastal sharks, and small coastal sharks also occupy this region.

Five federally-listed fish species may occur in the vicinity of the Project Area: Atlantic salmon (*Salmo salar*), Atlantic sturgeon (*Acipenser oxyrinchus oxyrinchus*), shortnose sturgeon (*Acipenser brevirostrum*), giant manta ray (*Manta birostris*), and oceanic whitetip shark (*Carcharhinus longimanus*); however, the Project Area does not overlap with critical habitat for any of these fish species (82 CFR 39160). While all five federally listed species have ranges that may include the SRWF and SRWEC, the Atlantic sturgeon is the only species whose occurrence is common enough that they may be exposed to impacts from Project activities. The only remaining populations of the Gulf of Maine DPS of the Atlantic salmon are in Maine. Smolts migrate from their natal river to foraging grounds in the North Atlantic, and after one or more winters at sea, adults return to their natal river to spawn. Atlantic salmon are not known to occur within or near the Project Area; the only potential for overlap with their distribution is during their migration route in the Gulf of Maine, which may be transited by vessels. There is no evidence of interactions between vessels and Atlantic salmon. Vessel strikes are not identified as a threat in the listing determination (74 Federal Register 29344) or the recent recovery plan (USFWS and

CONSTRUCTION AND OPERATIONS PLAN

Site Characterization and Assessment of Impacts – Biological Resources

NOAA Fisheries 2018), and there is no information to suggest that vessels in the ocean have any effects on migrating Atlantic salmon. Therefore, effects to Atlantic salmon are not expected even if migrating individuals co-occur with Project vessels moving between the Project site and distant ports. Therefore, only the Atlantic sturgeon is included in the impact assessment below. Species information and justification for excluding the shortnose sturgeon, giant manta ray, and oceanic whitetip shark from this assessment are provided in Appendix O.

The following summary of the regional effects of climate change on the distribution of finfish resources in the Project Area is provided as fisheries distributions in the Project Area, and across all of southern New England, are undergoing marked changes in response to ocean warming (Hare et al. 2016).

Benthic communities have experienced increased water temperatures in the region in the past several decades (Saba et al. 2016). The distributional ranges of dozens of groundfish species in New England waters have shifted northward and into deeper waters in response to increasing water temperatures (Nye et al. 2009; Pinsky et al. 2013) and more species are predicted to follow (Kleisner et al. 2017; Selden et al. 2018). The black sea bass (*Centropristis striata*), identified as particularly sensitive to habitat alteration (Guida et al. 2017), has been increasing in abundance over the past several years and is expected to continue its expansion in southern New England as water temperatures increase (Kuffner 2018; McBride et al. 2018). Several pelagic forage species have been increasing in the Project Area and surrounding waters, including Atlantic butterfish (*Peprilus triacanthus*), scup (*Stenotomus chrysops*), (Collie et al. 2008), and Atlantic mackerel (*Scomber scombrus*) (McManus et al. 2018).

Distributions of other species are reported to be shifting southward, including spiny dogfish (*Squalus acanthias*), little skate (*Leucoraja erinacea*), and silver hake (*Merluccius bilinearis*) (Walsh et al. 2015). It has been suggested that the spiny dogfish may replace the Atlantic cod (*Gadus morhua*) as a major predator in southern New England as the cod is driven north by warm waters that are well tolerated by the spiny dogfish (Selden et al. 2018).

Further temperature increases in southern New England are expected to exceed the global ocean average by at least a factor of two, and ocean circulation patterns are projected to change (Saba et al. 2016). Distributional shifts are occurring in both demersal and pelagic species, perhaps mediated by changes in spawning locations and shifts in spawning timing (Walsh et al. 2015). Southern species, including some highly migratory species such as mahi-mahi (*Coryphaena hippurus*) that prefer warmer waters, are expected to follow the warming trend and become more abundant in the area (South Atlantic Fishery Management Council 2003; Walsh et al. 2015). Climate change may also be affecting the migrations of anadromous fish in the region. The herrings, shad, and sturgeon were identified as having high biological sensitivity to adverse effects of climate change (Hare et al. 2016). In addition to physiological effects of temperature and pH, anadromous fish face a physical risk caused by flooding in their spawning rivers.

CONSTRUCTION AND OPERATIONS PLAN

Site Characterization and Assessment of Impacts – Biological Resources

Sunrise Wind Farm

Table 4.4.3-1 summarizes information on species of economic or ecological importance that are potentially present in the SRWF and surrounding region. The species listed in Table 4.4.3-1 were selected based on literature review, agency correspondence, fish sampling results from the Block Island Wind Farm, and EFH source document review. This table does not include every species that has the potential to occur in the SRWF but focuses on those that were (1) abundant in NEFSC trawl surveys (2003 to 2014) (described below); (2) commercially or recreationally important based on a review of VMS, Vessel Trip Reports (VTR), and landings data; (3) have been identified as important prey species; or (4) have designated EFH within the SRWF. The table delineates species characteristics, including habitat preference (demersal versus pelagic), early life stage presence, EFH designation, commercial/ recreational importance, potential prey species, and seasonality in the region. EFH and HAPC data were downloaded from the NOAA Habitat Conservation EFH Mapper (NOAA Fisheries 2020a). The data were queried using GIS software based on SRWF and manually verified.

Finfish species in southern New England generally have broad distributions, many ranging from Cape Hatteras, North Carolina, to Georges Bank and beyond. The Project Area supports finfish species typical of the region. The most recent 14-year summary of NEFSC seasonal trawls (2003–2016) in the RI-MA WEA demonstrates the diversity of fishes and squid in the area; 45 taxa were collected in the cold months and 45 in the warm months, with 59 species collected in total (Guida et al. 2017). Although some species occurred in both warm and cold seasons, the relative abundances varied substantially for most species by season. For example, seasonal trawl samples were dominated by Atlantic herring, winter skate, and little skate in cold months and longfin squid, butterfish, and scup in warm months. Little skate was the only species to dominate catch in both seasons (Guida et al. 2017).

While the majority of the SRWF is located within the RI-MA WEA, the southern portion falls within the MA WEA. Guida et al. (2017) noted that there was considerable overlap between the dominant cold and warm season species between the two adjacent WEAs, although a greater number of overall taxa (101) were captured within the much larger MA WEA. Both WEAs had Atlantic herring, little skate, and winter skate as cold season dominant species, and butterfish, little skate, longfin squid, scup, and spiny dogfish as warm season dominant species. Additional dominant species within the RI-MA WEA included longhorn sculpin, ocean pout, windowpane flounder, and yellowtail flounder in the cold season, and northern searobin in the warm season. Additional dominant species within the MA WEA included silver hake in the cold season and red hake, silver hake, and winter skate in the warm season.

Groundfish are an important part of the ecosystem within the SRWF and have an important economic role in the broader region. Some demersal species are present year-round in the Project Area; however, there are distinct variations in local populations because of seasonal migrations and inter-annual population dynamics (declines and increases) (Malek 2015). These migrations are often correlated with seasonal variation in water temperature. For more information about the commercial and recreational fishing activity within SRWF, see Section 4.7.4.

Atlantic cod has spawning habitat within localized regions near the SRWF. In southern New England, cod spawn during the winter, primarily from December through March (Dean et al. 2020; Langan et al. 2020). Tagging studies completed in other regions suggest that cod often demonstrate

CONSTRUCTION AND OPERATIONS PLAN

Site Characterization and Assessment of Impacts – Biological Resources

spawning site fidelity, returning to the same fine-scale bathymetric locations year after year to spawn (Hernandez et al. 2013; Siceloff and Howell 2013). However, such homing behavior has not yet been documented amongst individual cod in southern New England, although conventional tagging studies suggest there is little dispersal during the winter spawning season (Cadrin et al. 2020). An active Atlantic cod spawning ground has been identified in a broad geographical area that includes Cox Ledge and surrounding locations (Zemeckis et al. 2014). There is currently a BOEM funded acoustic telemetry study to better understand the distribution and habitat use of spawning cod on and around Cox Ledge. Additionally, in a sampling effort on Cox Ledge by Kovach et al. (2010), the majority of Atlantic cod collected were in spawning condition. In other studies, Atlantic cod was not among the consistently prevalent (top 25) species collected during multi-year sampling by otter trawl and beam trawl in areas that included Cox Ledge (Malek et al. 2014).

Pelagic communities within the RI-MA WEA are diverse and include the planktonic early life stages of most EFH species in the region, as well as early and late life stages of many highly migratory species (e.g., sharks and tunas). Pelagic habitats in the RI-MA WEA undergo substantial seasonal shifts in temperature, which is a major driver of seasonal fish migrations and may substantially influence ichthyoplankton settlement (Guida et al. 2017). Annual water column temperatures in the region can fluctuate seasonally by as much as 68°F (20°C) at the surface and as much as 54°F (12°C) at the bottom (Guida et al. 2017). Zooplankton communities within the region are diverse with more than 100 species identified in NEFSC surveys, including the copepod *Calanus finmarchicus* (NEFSC 2021). This species is considered an important food source for many larval and juvenile fish species and can be found in greatest abundance in the late spring and early summer (NEFSC 2021). An important food source for larval cod specifically is the copepod *Pseudocalanus* spp., which follows similar seasonal trends in abundance to *C. finmarchicus* (NEFSC 2021). Additional important copepod species in the region include *Centropages hamatus*, *Centropages typicus* and *Temora longicornis*.

Coastal pelagic species typically inhabit the sunlit zone over the continental shelf, in waters up to about 655 ft (200 m) deep (NOAA Fisheries 2018). Example coastal pelagic species that may be found in the Project Area include forage fish such as anchovy, shad, and menhaden, as well as the predatory fish that prey on them. Certain pelagic species are considered highly migratory species; they travel long distances and often cross domestic and international boundaries. These include oceanic pelagic species such as tunas, billfishes, and many sharks. Within the SRWF, 15 species that are managed as highly migratory species have designated EFH (these include all listed sharks, except spiny dogfish, and tunas).

Many species of finfish that have pelagic life stages within the region are considered commercially or recreationally important. Twenty-seven species with pelagic life stages listed in Table 4.4.3-1 have designated EFH in the SRWF. For more information regarding designated EFH within the Project Area, see Appendix N.

There are several species of anadromous fish, which migrate between the ocean and lower-salinity riverine environments for spawning, with habitat within the Project Area. Demersal species of anadromous fish potentially present in and around the SRWF include striped bass and Atlantic sturgeon, and other pelagic species of anadromous fish that may be present include American shad, alewife, blueback herring, Atlantic menhaden, and Atlantic sea herring (BOEM 2013; Scotti et al. 2010).

CONSTRUCTION AND OPERATIONS PLAN

Site Characterization and Assessment of Impacts – Biological Resources

A summary of common habitat types for the finfish species that could potentially occur in the SRWF is provided in Table 4.4.3-2. Within the SRWF, 42 species of fish and invertebrates have life stages with designated EFH, including 26 with demersal life stages and 27 with pelagic life stages (Table 4.4.3-3). These species/life stages and descriptions of their designated EFH and HAPCs are described in detail in Appendix N.

Finfish often consume prey across multiple trophic levels, and their diet may change depending on their life stage. Both demersal and pelagic fish species may consume fish, invertebrates, planktonic organisms, and detritus. Shellfish, worms, copepods, and other invertebrates are predominant types of prey for finfish in New England waters. The most common vertebrate finfish prey species include herring, menhaden, northern sand lance, and silver hake. Common prey of juvenile and adult finfish species that are likely to occur in the SRWF are summarized in Table 4.4.3-4.

As mentioned previously, the federally listed Atlantic sturgeon could occur within the SRWF. The Atlantic sturgeon is an anadromous, subtropical species that can be found along the Atlantic coast from Labrador, Canada, to Florida (ASMFC 2019; Murdy et al. 1997) and is classified into five distinct population segments (DPSs) (i.e., the New York Bight, Gulf of Maine, Chesapeake Bay, Carolina, and South Atlantic DPSs), which are grouped by ranges according to designations published by NOAA Fisheries (77 Federal Register 5880; 77 Federal Register 5914). The DPS most likely to be found in the vicinity of the SRWF is the New York Bight DPS. The New York Bight DPS is federally listed as endangered and includes all anadromous Atlantic sturgeon that are spawned in the watersheds that drain into coastal waters from Chatham, Massachusetts, to the Delaware-Maryland border on Fenwick Island, Delaware. Within this range, Atlantic sturgeon have been documented in the Hudson and Delaware Rivers as well as at the mouth of the Connecticut and Taunton Rivers, and throughout Long Island Sound (77 Federal Register 5880; O'Leary et al. 2014). Atlantic sturgeon migrate into freshwater rivers to spawn in the spring and early summer, and migrate downriver in the summer or fall to reside in estuarine and marine waters (Atlantic Sturgeon Status Review Team 2007; NOAA Fisheries 2019; Breece et al. 2016). In a study by O'Leary et al. (2014), earlier findings were confirmed from a genetic analysis that three river spawning populations of Atlantic sturgeon (from the Hudson, James, and Delaware Rivers), are the primary sources of marine aggregations within the Mid-Atlantic Bight.

Atlantic sturgeon have been collected during trawl surveys in the New York Bight at water depths of 33 to 49 ft (10 to 15 m) (Dunton et al. 2010; Dunton et al. 2012; Dunton et al. 2015). Adult Atlantic sturgeon in the coastal ocean off Long Island typically occur deeper than 33 ft (10 meters) below the surface during the winter and spring months from November through April (Erickson et al. 2011). Atlantic sturgeon are most abundant in the coastal ocean during the spring and fall months (Dunton et al. 2010; Dunton et al. 2015; Breece et al. 2016). During the late spring and summer months, sturgeon are less abundant off the coast of Long Island when they move inshore to feed or spawn in coastal estuaries and rivers during that time (Dunton et al. 2010, Dunton et al. 2012; Dunton et al. 2015, Ingram et al. 2019). During the late fall and winter months, many subadult and adult Atlantic sturgeon move to deeper water (greater than 98 ft [30 m]) off the coast of New York (Ingram et al. 2019) or migrate south along the US coast (Dunton et al. 2010; Dunton et al. 2015; Breece et al. 2016).

CONSTRUCTION AND OPERATIONS PLAN

Site Characterization and Assessment of Impacts – Biological Resources

A NOAA Fisheries Biological Opinion of offshore wind activities in the Atlantic WEAs concluded that sturgeon are not expected to occur in dense aggregations and occurrences will mostly consist of migrating individuals (NOAA Fisheries 2013a). There is also no Critical Habitat designated for Atlantic sturgeon in the vicinity of the Project Area (NOAA Fisheries 2017a). However, juvenile and adult Atlantic sturgeon have been captured in otter trawls and sink gill nets in the vicinity of the SRWF (Stein et al. 2004). Through an evaluation of commercial bycatch data, Stein et al. (2004) found the greatest occurrence of offshore Atlantic sturgeon in Northeastern US waters to occur from November through May. Given this information, it is possible that adult Atlantic sturgeon may be present in the SRWF during this period. Atlantic sturgeon and potential impacts on them are discussed in further detail in Appendix O.

Sunrise Wind Export Cable – OCS

Table 4.4.3-1 summarizes species of economic or ecological importance potentially present within SRWEC–OCS, generally characterized by their life stage and location in the water column. The demersal, pelagic, anadromous, and highly migratory species present within the SRWEC–OCS are expected to be very similar to those discussed above for the SRWF. Of the 35 species with demersal life stages associated with the SRWF in Table 4.4.3-1, only two (Atlantic herring and Atlantic wolffish) are not expected to occur within the SRWEC–OCS. Pelagic and highly migratory species are potentially abundant nearshore and offshore along the proposed SRWEC–OCS route in the warm season and decline during the cold season (Scotti et al. 2010).

A summary of common habitat types for the finfish species that could potentially occur in the SRWEC–OCS is provided in Table 4.4.3-2. As described in Section 4.4.2, there are two predominant habitat types in the SRWEC–OCS. The western portion of the SRWEC–OCS is composed primarily of sand sheet habitat. Sand ripples were frequently observed in the benthic survey, suggesting high sediment mobility. Low energy muddy sand was observed along the eastern portion of the SRWEC–OCS out to the SRWF.

Common prey of juvenile and adult finfish species that could potentially occur in the SRWEC–OCS are summarized in Table 4.4.3-4.

Within a 0.5-mi (800-m) corridor around the SRWEC–OCS centerline, 45 species of fish and invertebrates have life stages with designated EFH, including 30 with demersal life stages and 26 with pelagic life stages (Table 4.4.3-3). These species/life stages and descriptions of their designated EFH and HAPC are described in detail in Appendix N.

General information regarding the life history and conservation status of Atlantic sturgeon can be found in the SRWF discussion above. While information is sparse regarding the offshore habitat use of Atlantic sturgeon in the Project Area, there has been more extensive research conducted in recent years on coastal and estuarine movements of the species, including three recently funded BOEM telemetry studies in the mid-Atlantic. A trawl study conducted by Dunton et al. (2015) along the south coast of Long Island, New York found that Atlantic sturgeon use the coastal areas along the entire region, with most individuals caught at depths less than 49 ft (15 m) and in areas of previously known aggregations. Data analyzed within this study also indicated that adult and juvenile Atlantic sturgeon are found further offshore as seen in commercial otter trawl and sink gill net bycatch databases. Spring was identified as the time of year with the greatest bycatch rates along the eastern end of Long Island.

CONSTRUCTION AND OPERATIONS PLAN

Site Characterization and Assessment of Impacts – Biological Resources

Data from the Dunton et al. (2015) trawl survey and the Northeast Fisheries Observer Program bycatch database indicate that Atlantic sturgeon may be present along the SRWEC–OCS. See Appendix O for additional species information.

Sunrise Wind Export Cable – NYS

Table 4.4.3-1 summarizes species of economic or ecological importance potentially present within SRWEC–NYS, generally characterized by their life stage and location in the water column. Species summarized in the table as potentially occurring in the SRWEC may be found within both the OCS and NYS portions of the export cable route.

The demersal, pelagic, anadromous, and highly migratory species expected to be present within the SRWEC–NYS overlap substantially with the species described for the SRWEC–OCS.

Many finfish that have demersal life stages in Table 4.4.3-1 are considered commercially or recreationally important in New England and NYS waters. While fisheries occurring along the SRWEC–OCS and in SRWF waters are managed under the MSFCMA, fisheries in NYS waters are primarily managed by the NYSDEC. Demersal species including black sea bass, bluefish, scup, spiny dogfish, and summer flounder are individually managed under respective NYS Quota Distribution Programs within NYS waters. Silver hake, scup, skates, and summer flounder were the top finfish species landed by pounds by commercial fishermen in NYS waters from the years 2008 to 2010 of all demersal species listed in Table 4.4.3-1 (Scotti et al. 2010). More information about commercial and recreational fishing and their socioeconomics is described in Section 4.7.4.

Of the anadromous species that are potentially present in the SRWEC, several are considered commercially or recreationally important within NYS waters including Atlantic menhaden and striped bass. More detailed information regarding recreational and commercial important finfish species is described in Section 4.7.4.

A summary of common habitat types for the finfish species that could potentially occur in the SRWEC–NYS is provided in Table 4.4.3-2. As part of the benthic habitat survey, SPI/PV stations were sampled along the SRWEC–NYS in August 2020 and the results of that survey are included herein.

Common prey of juvenile and adult finfish species that could potentially occur in the SRWEC–NYS are summarized in Table 4.4.3-4.

Within a 0.5-mi (800-m) corridor around the SRWEC–NYS centerline, 32 species of fish and invertebrates have life stages with designated EFH, including 20 with demersal life stages and 21 with pelagic life stages (Table 4.4.3-3). These species/life stages and descriptions of their designated EFH and HAPC are described in detail in Appendix N.

Atlantic sturgeon may be present along the SRWEC–NYS corridor as described in the SRWEC–OCS section above. Additional discussion of Atlantic sturgeon and potential impacts on them within state waters is provided in Appendix O.

CONSTRUCTION AND OPERATIONS PLAN

Site Characterization and Assessment of Impacts – Biological Resources

Onshore Facilities

The Onshore Transmission Cable route crosses under the ICW between Bellport Bay and Narrow Bay, just west of the Smith Point Bridge, then crosses under the Carmans River (Figure 4.4.3-1). Because data are not available for the specific location where the ICW HDD may occur, information from Great South Bay are provided. Table 4.4.3-1 summarizes species of economic or ecological importance potentially present within the vicinity of the Onshore Transmission Cable, generally characterized by their life stage, location in the water column, or presence within Carmans River.

Great South Bay is identified as the largest protected, shallow, coastal bay in New York State. Many of the commercially and ecologically important demersal, pelagic, and anadromous species expected to be present along the Onshore Transmission Cable utilize areas within the Great South Bay as important forage, nursery, and spawning habitat. Forage finfish species can be found throughout Great South Bay at different times of the year. The USFWS Northeast Coastal Areas Study (1991) identified Atlantic silverside as the most dominant finfish species year-round. The report also identified bay anchovy as a dominant forage species in the summer and sand lance in the winter (USFWS 1991). As a result of the abundance of forage species in Great South Bay, the bay is utilized as forage and nursery habitat for a variety of species identified as commercially or recreationally important, including summer flounder, winter flounder, bluefish, black sea bass, cunner, striped bass, weakfish, and tautog (USFWS 1991). Striped bass are the primary commercially important anadromous species in Great South Bay, but additional, ecologically important species such as anadromous alewife utilize the bay during their seasonal spring migration up the Carmans River (NYSDEC 2008).

Within Great South Bay, 17 species of fish and invertebrates have life stages with designated EFH, (Table 4.4.3-3). These species/life stages and descriptions of their designated EFH and HAPC are described in detail in Appendix N.

The Carmans River is located in the Town of Brookhaven, Long Island, and extends approximately 10 mi (16 km) from central Long Island to Bellport Bay (part of Great South Bay) (NYSDEC 2008). Carmans River is identified as one of only four major riverine systems on Long Island and it contains extensive undeveloped lands. The tidal river begins approximately 2 mi (3 km) north of Bellport Bay and is primarily within the Wertheim National Wildlife Refuge (NYSDEC 2008), which is to the south of the Onshore Transmission Cable. The Onshore Transmission Cable crosses the Carmans River where it is classified as freshwater. The tidal portion of the river supplies important nursery habitat for striped bass and bluefish, as well as spawning and nursery habitats for alewife, Atlantic menhaden, white perch, and Atlantic silverside (NYSDEC 2008). Many freshwater fish species occur in the river including a naturally reproducing population of brook trout, yellow perch, white perch, largemouth bass, black crappie, and unusually abundant concentrations of Eastern pirate perch (NYSDEC 2008). American eel juveniles and adults can be found in both the tidal and freshwater portions of the river (NYSDEC 2008.) The Carmans River is also identified as one of the few streams on Long Island that supports concentrations of sea-run brown trout and wild brook trout (NYSDEC 2008).

This page intentionally left blank

Figure 4.4.3-1
Long Island South Shore
Benthic Habitat

Sunrise Wind

Powered by
 Ørsted &
 Eversource

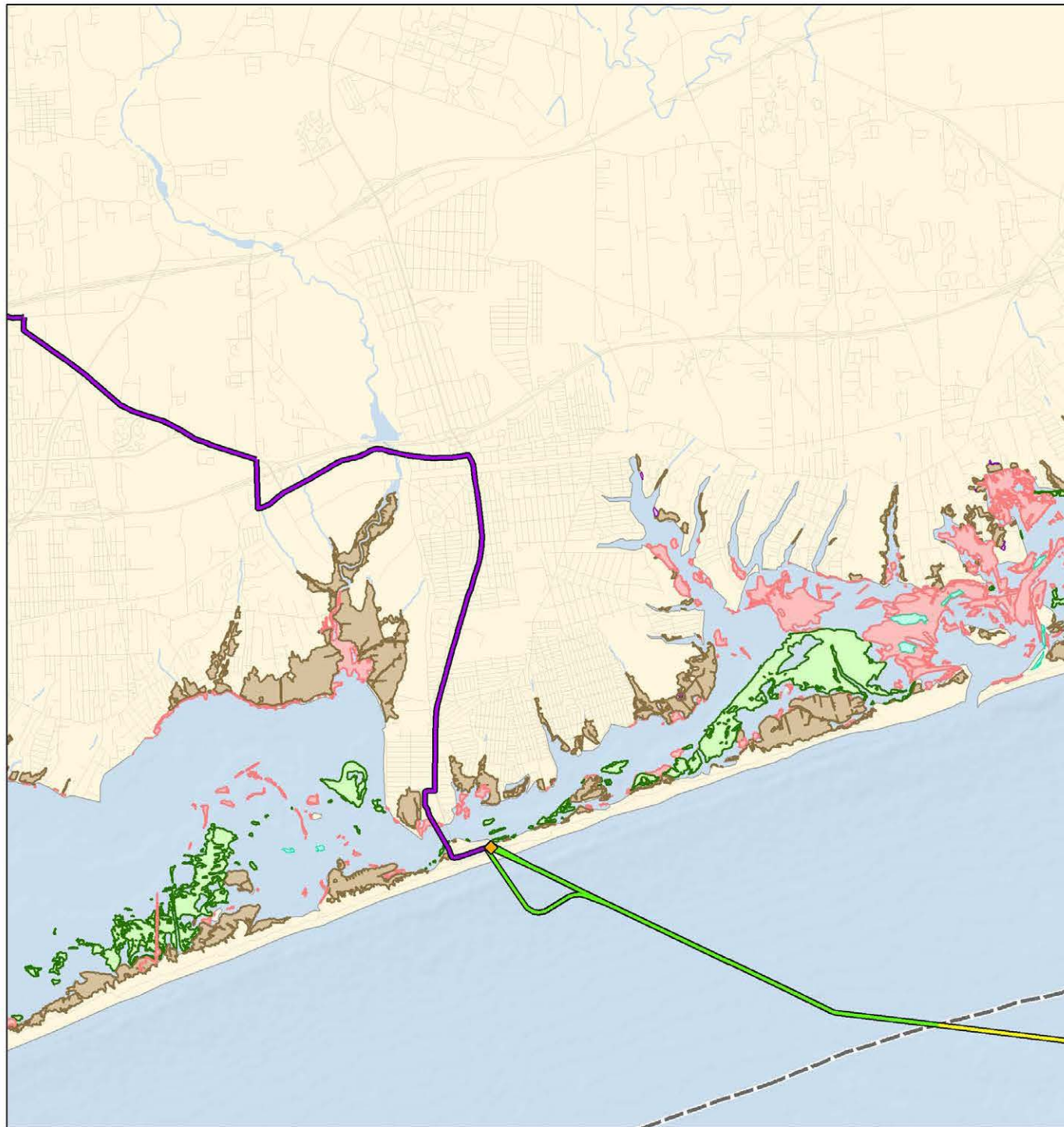

Legend

- SRWEC Landfall Location
- Sunrise Wind Export Cable (SRWEC-NYS)
- Sunrise Wind Export Cable (SRWEC-OCS)
- Onshore Transmission Cable – LIE Service Road RT
- 3 Nautical Mile State Water Boundary

2018 Long Island South Shore Estuary Benthic Habitat

- Seagrass Beds
- Benthic Macroalgae
- Emergent Wetland
- Mollusk Reef Biota
- Scrub-Shrub Wetland

Sources

1. Base map: ESRI Oceans
2. Benthic Habitat: NYSDOS 2018

Date	11/30/2020
Project Number	
Prepared By	
Reviewed By	

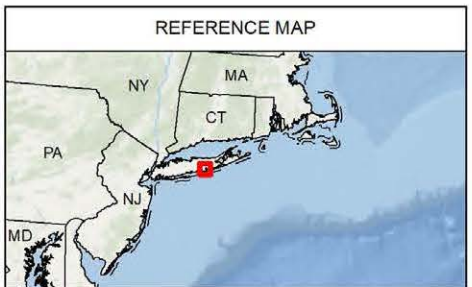
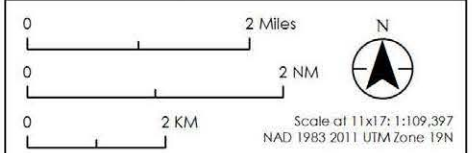

This page intentionally left blank

CONSTRUCTION AND OPERATIONS PLAN

Site Characterization and Assessment of Impacts – Biological Resources

Table 4.4.3-1 Economically and Ecologically Important Finfish Species in the SRWF, SRWEC, and Onshore Transmission Cable

Species	Eggs	Larvae	Juveniles	Adults	EFH	Commercial/ Recreational Importance	Prey Species	Potential Time of Year in Region ^a
Demersal/Benthic								
Atlantic Cod (<i>Gadus morhua</i>) ^b			•	•	X	X		Year-round, peak in winter and spring
Atlantic Halibut (<i>Hippoglossus hippoglossus</i>) ^b			•	•		X		Year-round
Atlantic Herring (<i>Clupea harengus</i>) ^b	SRWF*				X	X	X	Winter
Atlantic Sturgeon (<i>Acipenser oxyrinchus oxyrinchus</i>)			•	•				October to May
Atlantic Wolffish (<i>Anarhichas lupus</i>)	SRWF*	SRWF*	SRWF*	SRWF*	X			November to June
Barndoor Skate (<i>Dipturus laevis</i>)			•	•	X	X		Year-round
Black Sea Bass (<i>Centropristis striata</i>) ^b			• ^e	• ^e	X	X		Spring to summer; summer to fall
Cunner (<i>Tautoglabrus adspersus</i>)			•	•			X	Year-round, hibernate in mud over winter
Fourspot Flounder (<i>Paralichthys oblongus</i>)			•	•			X	Spring to fall
Golden Tilefish (<i>Lopholatilus chamaeleonticeps</i>)		•	•			X		Larvae: July to September; Juveniles: April to July
Haddock (<i>Melanogrammus aeglefinus</i>) ^b			•	SRWEC*	X	X		Winter and spring
Little Skate (<i>Leucoraja erinacea</i>)			• ^e	• ^e	X	X		Year-round
Longhorned Sculpin (<i>Myoxocephalus octodecemspinosus</i>)			•	•				Winter and spring
Monkfish (<i>Lophius americanus</i>) ^b			•	•	X	X		Summer to fall
Northern Seabrobin (<i>Prionotus carolinus</i>)			•	•		X		Spring through fall
Ocean Pout (<i>Macrozoarces americanus</i>)	•		•	•	X	X	X	Late summer to winter

CONSTRUCTION AND OPERATIONS PLAN

Site Characterization and Assessment of Impacts – Biological Resources

Species	Eggs	Larvae	Juveniles	Adults	EFH	Commercial/ Recreational Importance	Prey Species	Potential Time of Year in Region ^a
Pollock (<i>Pollachius virens</i>)			• ^e		J	X		Collected in November at Block Island Wind Farm (BIWF)
Red Hake (<i>Urophycis chuss</i>) ^b			•	•	X	X	X	Year-round
Sand Lance (<i>Ammodytes americanus</i>)	•	•	•	•			X	Year-round
Scup (<i>Stenotomus chrysops</i>)			• ^e	• ^e	X	X	X	Juveniles: winter to spring; Adults: October to December
Sea Raven (<i>Hemitripterus americanus</i>)	•	•	•	•				Collected Year-Round at BIWF
Silver Hake (<i>Merluccius bilinearis</i>) ^b			•	SRWEC* ^e	X	X	X	Spring to fall
Smoothhound shark (<i>Mustelus canis</i>)			• ^{d,e}	• ^e	X			Fall to winter Collected spring through fall at BIWF
Spiny Dogfish (<i>Squalus acanthias</i>)			SRWEC* ^e	• ^e	X	X		Fall to winter Collected summer and fall at BIWF
Spotted Hake (<i>Urophycis regia</i>)			•	•			X	Spring to fall
Striped Bass (<i>Morone saxatilis</i>)			• ^e	•		X		Spring to fall
Striped Searobin (<i>Prionotus evolans</i>)			•	•			X	Year-round
Summer Flounder (<i>Paralichthys dentatus</i>) ^b			SRWEC* ^e	• ^e	X	X		Spring to fall
Tautog (<i>Tautoga onitis</i>)			•	•		X	X	Year-round
White Hake (<i>Urophycis tenuis</i>)		•	SRWEC* ^e		X	X	X	Spring to fall
Windowpane Flounder (<i>Scophthalmus aquosus</i>) ^b			• ^e	• ^e	X	X	X	Year-round
Winter Flounder (<i>Pseudopleuronectes americanus</i>) ^b	SRWEC* ^e	• ^e	• ^e	• ^e	X	X	X	Eggs: Spring Juveniles and Adults: year-round
Winter Skate (<i>Leucoraja ocellate</i>)			• ^e	• ^e	X	X		Fall to spring Collected year-round at BIWF

CONSTRUCTION AND OPERATIONS PLAN

Site Characterization and Assessment of Impacts – Biological Resources

Species	Eggs	Larvae	Juveniles	Adults	EFH	Commercial/ Recreational Importance	Prey Species	Potential Time of Year in Region ^a
Witch Flounder (<i>Glyptocephalus cynoglossus</i>) ^b			SRWEC*	•	X	X	X	Spring to summer
Yellowtail Flounder (<i>Limanda ferruginea</i>) ^b			•	•	X	X	X	Year-round
Pelagic								
Albacore Tuna (<i>Thunnus alalunga</i>)			•	•	X	X		Summer to fall
Alewife (<i>Alosa pseudoharengus</i>)			• ^e	• ^e		X	X	Summer to winter Collected January to May at BIWF
American Eel (<i>Anguilla rostrata</i>)		• ^e	• ^e	• ^e		X		Juveniles or Adults: March through December. One adult collected in April at BIWF
American Plaice (<i>Hippoglossoides platessoides</i>)		SRWEC*			X		X	Spring
American Shad (<i>Alosa sapidissima</i>)			•	•		X	X	Spring to summer
Atlantic Bonito (<i>Sarda sarda</i>)			•	•		X		Summer to fall
Atlantic Butterfish (<i>Peprilus triacanthus</i>)	•	•	•	•	X	X	X	Eggs/Larvae: May to September; Juveniles/Adults: Spring to fall Adults: Collected in summer and fall at BIWF
Atlantic Cod ^c	•	•			X	X	X	Year-round
Atlantic Halibut ^c	•	•				X	X	Winter and spring
Atlantic Herring ^c		•	• ^e	• ^e	X	X	X	Larvae: August to December; Juveniles/Adults: spring and fall Juveniles/Adults: Collected January to March at BIWF
Atlantic Mackerel (<i>Scomber scombrus</i>)	• ^e	• ^e	• ^e	• ^e	X	X	X	Eggs/Larvae: April to June; Juveniles/Adults: late summer to fall Juveniles/Adults: Collected January through February at BIWF
Atlantic Menhaden (<i>Brevoortia tyrannus</i>)			• ^e	• ^e		X	X	Spring to summer
Atlantic silverside (<i>Menidia menidia</i>)			• ^e	• ^e			X	Late fall to early spring

CONSTRUCTION AND OPERATIONS PLAN

Site Characterization and Assessment of Impacts – Biological Resources

Species	Eggs	Larvae	Juveniles	Adults	EFH	Commercial/ Recreational Importance	Prey Species	Potential Time of Year in Region ^a
Basking Shark (<i>Cetorhinus maximus</i>)			• ^d	•	X			Summer to fall
Bay anchovy (<i>Anchoa mitchilli</i>)	SRWEC*	SRWEC*	SRWEC*	SRWEC*			X	Eggs and Larvae: spring, summer, fall Juveniles and Adults: year-round Populations expected to be low and more evident in the SRWEC—NYS than the SRWEC—OCS.
Black Sea Bass ^c	•	•				X	X	July to September
Blueback Herring (<i>Alosa aestivalis</i>)			•	•		X	X	Summer to winter Collected in the winter at BIWF
Bluefin Tuna (<i>Thunnus thynnus</i>)			•	•	X	X		Spring to fall
Bluefish (<i>Pomatomus saltatrix</i>)	•	•	SRWEC* ^e	• ^e	X	X	X	Eggs: April to August; Larvae: April to September; Juveniles and Adults: June through October, collected September through November at BIWF
Blue shark (<i>Prionace glauca</i>)			• ^d	•	X			June to November
Common Thresher Shark (<i>Alopias vulpinus</i>)			• ^d	•	X			June to December
Conger Eel (<i>Conger oceanicus</i>)			•	•				Collected November to June at BIWF
Dusky Shark (<i>Carcharhinus obscurus</i>)			• ^d	•	X			June to November
Haddock ^c	•	•			L	X	X	Winter and spring
Monkfish ^c	•	•			X	X	X	Summer to fall
Northern Seabobin	•	•					X	Year-round
Offshore Hake (<i>Merluccius albidus</i>)		SRWEC*			X	X	X	Year-round
Pollock ^c	•	•			X	X		September to July
Porbeagle Shark (<i>Lamna nasus</i>)			• ^d	•	X			Winter to Spring

CONSTRUCTION AND OPERATIONS PLAN

Site Characterization and Assessment of Impacts – Biological Resources

Species	Eggs	Larvae	Juveniles	Adults	EFH	Commercial/ Recreational Importance	Prey Species	Potential Time of Year in Region ^a
Red Hake ^c	•	•			X	X	X	May to November
Sandbar Shark (<i>Carcharhinus plumbeus</i>)			• ^{d,e}	•• ^e	X			May to September
Sand Tiger Shark (<i>Carcharias taurus</i>)			• ^{d,e}		X			May to November
Shortfin Mako Shark (<i>Isurus oxyrinchus</i>)			• ^d	•	X			June to December
Silver hake ^c	•	•			X	X		Year-round
Skipjack Tuna (<i>Katsuwonus pelamis</i>)			•	•	X	X		Summer to fall
Spot (<i>Leiostomus xanthurus</i>)			•	•		X		Summer to Fall
Summer Flounder ^c	•	•			X	X	X	October to May
Tiger Shark (<i>Galeocerdo cuvieri</i>)			•	•	X			May to September
Weakfish (<i>Cynoscion regalis</i>)			•	•		X	X	Spring and Summer
White Shark (<i>Carcharodon carcharias</i>)			• ^{d,e}	•	X			Summer to fall
Windowpane Flounder ^c	• ^e	• ^e			X	X	X	Spring
Winter Flounder ^c		• ^e			X	X	X	Winter to spring
Witch Flounder ^c	•	•			X	X	X	Year-round
Yellowfin Tuna (<i>Thunnus albacares</i>)			•	•	X	X		Summer to fall
Yellowtail Flounder ^c	•	•			X	X	X	March to August
Freshwater (Carmans River)								
Black crappie (<i>Pomoxis nigromaculatus</i>)	OnTC*	OnTC*	OnTC*	OnTC*		X		Year-round
Brook Trout (<i>Salvelinus fontinalis</i>)	OnTC*	OnTC*	OnTC*	OnTC*		X		Year-round
Brown trout (<i>Salmo trutta</i>)	OnTC*	OnTC*	OnTC*	OnTC*		X		Year-round
Largemouth bass (<i>Micropterus salmoides</i>)	OnTC*	OnTC*	OnTC*	OnTC*		X		Year-round

CONSTRUCTION AND OPERATIONS PLAN

Site Characterization and Assessment of Impacts – Biological Resources

Species	Eggs	Larvae	Juveniles	Adults	EFH	Commercial/ Recreational Importance	Prey Species	Potential Time of Year in Region ^a
Eastern Pirate Perch (<i>Aphredoderus sayanus</i>)	OnTC*	OnTC*	OnTC*	OnTC*				Year-round
White perch (<i>Morone americana</i>)	OnTC*	OnTC*	OnTC*	OnTC*		X		Year-round
Yellow perch (<i>Perca flavescens</i>)	OnTC*	OnTC*	OnTC*	OnTC*		X		Year-round

SOURCES:
 Bohaboy et al. 2010; Cargnelli et al. 1999a; Cargnelli et al. 1999b; Cargnelli et al. 1999c; Cargnelli et al. 1999d; Chang et al. 1999; Collette and Klein-MacPhee 2002; Collie et al. 2008; Collie and King 2016; Cross et al. 1999; Curtice et al. 2016; Demarest 2009; Fahay et al. 1999a, 1999b; Fairchild 2017; Fisheries Hydroacoustic Working Group 2008; Greater Atlantic Regional Fisheries Office (GARFO) 2019; Gerry and Scott 2010; Hasbrouck et al. 2011; INSPIRE 2018a; Johnson et al. 1999a, 1999b; Lipsky 2014; Malek et al. 2010, 2014, 2016; Massachusetts Department of Energy and Environmental Affairs 2017; MA Executive Office of Energy and Environmental Affairs 2015; McBride et al. 2002; McGuire et al. 2016; Morse et al. 1999; Morton 1989; NOAA 2015, 2016, 2020a, 2020b; NOAA Fisheries 2017b; NEFMC 2017; NEFSC 2004, 2017; Northeast Ocean Data 2017; NYSDEC 2008, 2020; Packer et al. 1999, 2003a, 2003b, 2003c; Pereira et al. 1999; Petruny-Parker et al. 2015; Popper et al. 2014; Reid et al. 1999; RIDEM 2019; Rooker et al. 2007; Scotti et al. 2010; Siemann and Smolowitz 2017; Steimle et al. 1999a, 1999b, 1999c, 1999d, 1999e; Studholme et al. 1999; USFWS 1999, 2020a, 2020b, 2020c, 2020d, 2020e; URI EDC 1998a, 1998b; URI GSO 2019; Wilber et al. 2017; Wood et al. 2009.

NOTES:
 a/ Time of year information obtained from sources listed in the reference section. When available, species presence based on survey information from the Block Island Wind Farm (BIWF) was provided from INSPIRE 2018a.
 b/ This species also has life stages that are pelagic.
 c/ This species also has life stages that are demersal.
 d/ Juveniles for this species include the neonate and juvenile life stage.
 e/ Life stage also identified as potentially present along Onshore Transmission Cable (OnTC) route

• - denotes that the life stage is potentially present in both the SRWF and along the SRWEC. SRWF* – denotes that the life stage is potentially present only in the SRWF, according to EFH designations. SRWEC* – denotes that the life stage is potentially present only in the SRWEC, according to EFH designations. OnTC* – denotes that the life stage is potentially only present in the Onshore Transmission Cable.

EFH column – X indicates EFH is designated for all life stages checked in that row. E, L, J, A indicates that only certain life stages have EFH. E=eggs, L=larvae, J=juveniles, A=adults

CONSTRUCTION AND OPERATIONS PLAN

Site Characterization and Assessment of Impacts – Biological Resources

Table 4.4.3-2 Common Habitat Types for Finfish Species Known to Occur in the Region

Species	Habitat Type by Life Stage
Demersal/Benthic	
Atlantic Cod	Juveniles: Cobble substrates both nearshore and offshore; wide temperature ranges. Adults: On or near the bottom along rocky slopes of ledges; depths between 131 and 426 ft (40 and 130 m) but also midwater.
Atlantic Halibut	Juveniles: Coastal areas 65 to 196 ft (20 to 60 m) deep; sandy bottom. Adults: Areas at depths of 328 to 2,296 ft (100 to 700 m) over sand, gravel, or clay bottoms.
Atlantic Herring	Eggs: Spawning at depths of 131 to 262 ft (40 to 80 m) on George's Bank on gravel (preferred); sand, rocks, shell fragments, aquatic macrophytes, and lobster pot structures.
Atlantic Sturgeon	Juveniles: In the wintertime, juveniles congregate in a deep-water habitat in estuaries. Most are found over clay, sand, and silt substrates. Adults: Primarily a marine species that is found close to shore; however, it does migrate long distances.
Atlantic Wolffish	All Life Stages: Occupy complex habitats with large stones or rocks at a depth range of 131 to 787 ft (40 to 240 m).
Barndoor Skate	Juveniles and adults: Benthic continental shelf habitats at depths of 131 to 1312 ft (40–400 m), and on the continental slope to a maximum depth of 2460 ft (750 m) on mud, sand, and gravel substrates.
Black Sea Bass	Juveniles: Collected at depths of 65 to 787 ft (20 to 240 m) in channel environments. Adults: At depths of 98 to 787 ft (30 to 240 m) in shipwrecks, rocky and artificial reefs, mussel beds, and other structures along the bottom.
Cunner	All Life Stages: Coastwise fish that prefers eel grass, rock pools, or pilings at depths 13 to 23 ft (4 to 7 m).
Golden Tilefish	All Life Stages: 262- to 590-foot (80- to 180-m) depth along the outer part of the continental shelf to upper part of continental shelf.
Haddock	Adults: Pebble gravel bottom at depths of 131 to 492 ft (40 to 150 m).
Little Skate	All Life Stages: Sandy/gravelly bottoms at a depth range of less than 233 to 298 ft (71 to 91 m).
Monkfish	Juveniles/Adults: Bottom habitat, sand/shell mix, gravel or mud along the continental shelf, depths 82 to 656 ft (25 to 200 m).
Northern Seabobin	Juveniles and Adults: Smooth, hard-packed bottom.
Ocean Pout	All Life Stages: Bottom habitats with rocky shelter from the intertidal continental shelf to 656 ft (200 m) deep.
Pollock	Juveniles: Rocky bottom habitats with attached macroalgae from the intertidal zone to 600 ft (182 m).
Red Hake	Juveniles: Use of shells and substrate as shelter; found less than 393 ft (120 m) to low tide line. Adults: Shell beds, soft sediments, and artificial reefs.
Sand Lance	All Life Stages: Throughout water column over sandy substrates.
Scup	Juveniles: Nearshore in sandy, silty-sand, mud, mussel beds, and eel grass at depths of 16 to 55 ft (5 to 17 m). Adults: Soft, sandy bottom, near structures (ledges, artificial reefs, mussel beds) at a depth range less than 98 ft (30 m).
Sea Raven	All Life Stages: Prefer rocky ground; hard clay, pebbles, or sand from 300 to 630 ft (91 to 192 m) deep.
Silver Hake	Juveniles: Bottom habitats; all substrate types; depths of 65 to 885 ft (20 to 270 m). Adults: Bottom habitats; all substrate types; depths of 98 to 1,066 ft (30 to 325 m).
Smoothhound Shark	All Life Stages: Mostly nearshore but some have a depth range of 870 to 990 ft (145 to 165 m); prefer bottom habitats.

CONSTRUCTION AND OPERATIONS PLAN

Site Characterization and Assessment of Impacts – Biological Resources

Species	Habitat Type by Life Stage
Spiny Dogfish	All Life Stages: Collected over sand, mud, and mud-sand transitions at depths ranging from 3 to 1,640 ft (1 to 500 m); do not travel to maximum depths in the fall.
Striped Bass	All Life Stages: Open waters along rocky shores and sandy beaches.
Summer Flounder	Adults: Prefer sandy habitats; captured from shoreline to 82 ft (25 m) deep.
Tautog	All Life Stages: Require complex, structured habitats with a hard bottom substrate; depths of 82 to 989 ft (25 to 30 m).
White Hake	Juveniles: Nearshore waters on fine-grained, sandy substrates in eelgrass, macroalgae, and un-vegetated habitats. Adults: Sub-tidal benthic habitats on fine-grained, muddy substrates and in mixed soft and rocky habitats at depths up to 2952 ft (900 m).
Windowpane Flounder	Juveniles and Adults: Fine, sandy sediment; nearshore less than 246 ft (75 m) deep.
Winter Flounder	Eggs: Nearshore; mud to sand or gravel. Larvae: Nearshore; fine sand to gravel. Juveniles: 59 to 88 ft (18 to 27 m) deep; mud or sand-shell. Adults: Mostly nearshore up to 98 ft (30 m) deep; mud, sand, cobble, rocks, or boulders substrate.
Winter Skate	All Life Stages: Prefer sandy or gravelly substrates; spring depths from 3 to 984 ft (1 to 300 m); fall depths from 3 to 1,312 ft (1 to 400 m).
Witch Flounder	Juveniles and Adults: Bottom habitats with mud and muddy sand
Yellowtail Flounder	Juveniles: Sand or sand and mud; depth range of 16 to 410 ft (5 to 125 m). Adults: Sand or sand and mud; depth range of 32 to 1,181 ft (10 to 360 m).
Pelagic	
Albacore Tuna	All Life Stages: Deepwater habitats; depth range of 0 to 1,968 ft (0 to 600 m).
Alewife	Adults: Shorelines; shallower waters near estuaries.
American Eel	Larvae: Drift with Gulf Stream toward Atlantic Coast. Juveniles: Glass eels and elvers migrate to brackish waters; some remain in marine waters. Adults: Freshwater, coastal, and marine waters.
American Plaice	Larvae: Open waters; depth maximum 328 ft (100 m).
American Shad	Juveniles: Nearshore open waters. Adults: Open ocean.
Atlantic Bonito	All Life Stages: Open waters both nearshore and offshore.
Atlantic Butterfish	Eggs: Surface waters along the edge of the continental shelf to estuaries and bays. Larvae and Juveniles: Surface waters from continental shelf to bays. Adults: Surface waters from depths of 885 to 1,377 ft (270 to 420 m).
Atlantic Cod	Eggs: Bays, harbors, offshore banks; float near water surface. Larvae: Open ocean and continental shelf area.
Atlantic Halibut	Eggs: Offshore drift suspended in the water column. Larvae: Nearshore areas near the water surface.
Atlantic Herring	All Life Stages: High energy environments; gravel seafloors.

CONSTRUCTION AND OPERATIONS PLAN

Site Characterization and Assessment of Impacts – Biological Resources

Species	Habitat Type by Life Stage
Atlantic Mackerel	Eggs: Shoreward side of the continental shelf; 32 to 1,066.27 ft (10 to 325 m) deep. Larvae: Offshore waters and open bays; 32 to 426 ft (10 to 130 m) deep. Juveniles: Nearshore areas; 164 to 229 ft (50 to 70 m) deep. Adults: Offshore, 32 to 1,115 ft (10 to 340 m) deep.
Atlantic Menhaden	All Life Stages: Estuaries and coastal waters.
Atlantic silverside	Juveniles and Adults: Found at great depths offshore from late fall through early spring. In the summer, they are found along the shore, within a few ft of the shoreline along sandy or gravel shores.
Basking Shark	All Life Stages: Coastal and offshore; sometimes enters inshore bays.
Bay anchovy	Eggs/Larvae: Eggs are found throughout the water column but tend to be concentrated near the surface. Larvae move upstream to lower salinity waters in the spring and then move to more saline waters in the fall. Juveniles and Adults: shallow and moderately deep offshore waters, nearshore waters off sand beaches, open bays, and muddy coves.
Black Sea Bass	Eggs: Coastal, upper water column. Larvae: Nearshore, mouths of estuaries, upper water column.
Blueback Herring	Adults: High energy environments; gravel seafloors.
Bluefin Tuna	All Life Stages: Nearshore and offshore.
Bluefish	Eggs: Across continental shelf; transported further offshore. Larvae: Near edge of continental shelf; associated with surface. Juveniles: Nearshore; associated with surface. Adults: Nearshore to offshore.
Blue Shark	All Life Stages: Nearshore and offshore, surface dwelling, concentrated near fishing activity.
Common Thresher Shark	Juveniles: Shallower waters over the continental shelf (less than 656 ft [200 m] deep) in areas of upwelling or mixing. Adults: Present near and offshore, but more common nearshore, in areas of upwelling or mixing.
Conger Eel	All Life Stages: Near the coast line to the edge of the continental shelf, 50 to 142 fathoms deep.
Dusky Shark	All Life Stages: Near and offshore.
Haddock	Eggs: Near the surface of water column. Larvae: Depths of 32 to 164 ft (10 to 50 m) with a maximum depth of 492 ft (150 m).
Monkfish	Eggs: Surface waters in areas that have depths of 49 to 3,280 ft (15 to 1000 m). Larvae: Pelagic waters in areas that have depths of 49 to 3,280 ft (15 to 1000 m).
Northern Seabobin	Eggs and Larvae: Pelagic waters of the continental shelf.
Offshore Hake	Larvae: Pelagic habitats along the outer continental shelf and slope that have depths of 197 to 4,921 ft (60 to 1500 m)
Porbeagle Shark	All Life Stages: Pelagic habitats in deep, cold offshore waters.
Red Hake	Eggs: Water column within the inner shelf. Larvae: Coastal waters less than 656 ft (200 m) in depth.
Sandbar Shark	All Life Stages: Waters on continental shelves, oceanic banks, and island terraces, but also found in harbors, estuaries, at the mouths of bays and rivers, and shallow turbid water. Mostly at 65 to 213 ft (20 to 65 m) deep.
Sand Tiger Shark	All Life Stages: Nearshore ranging in depths from 6 to 626 ft (2 to 191 m); inhabit surf zone, shallow bays, and rocky reefs, and deeper areas around the OCS.

CONSTRUCTION AND OPERATIONS PLAN

Site Characterization and Assessment of Impacts – Biological Resources

Species	Habitat Type by Life Stage
Shortfin Mako Shark	All Life Stages: Various areas of the water column; ranging depths, maximum depth 2,427 ft (740 m).
Silver hake	Eggs: Surface waters over continental shelf at depths of 164 to 492 ft (50 to 150 m). Larvae: Surface waters over the continental shelf at depths of 164 to 426 ft (50 to 130 m).
Skipjack Tuna	All Life Stages: Epipelagic, oceanic species.
Spot	All Life Stages: Coastal, nearshore, and offshore continental shelf areas.
Summer Flounder	Eggs and Larvae: Nearshore areas within eel grass beds and pilings.
Tiger Shark	Juveniles and Adults: Coastal, nearshore, and offshore continental shelf areas.
Weakfish	All Life Stages: Nearshore, shallow waters along open sandy shores and estuaries.
White Shark	All Life Stages: Nearshore and offshore, mostly spotted near the surface.
Windowpane Flounder	Eggs and Larvae: Occupy multiple areas in water column less than 229-foot (70-m) depths.
Winter Flounder	Larvae: Both nearshore and offshore.
Witch Flounder	Eggs: Deep; pelagic waters 164- to 278-foot (50- to 85-m) depths. Larvae: 0- to 820-foot (0- to 250-m) depths.
Yellowfin Tuna	All Life Stages: epipelagic, oceanic fish found in the upper 328 ft (100 m) of the water column.
Yellowtail Flounder	Eggs: Pelagic – near-surface continental shelf waters. Larvae: Pelagic – mid-water column; movement limited to currents.
Freshwater (Carmans River)	
Black crappie	All Life Stages: lakes, ponds, sloughs, backwaters pools and streams with vegetated habitat over mud or sand; fallen trees or boulders.
Brook Trout	All Life Stages: Streams, lakes, and ponds with sand or gravel bottom and submerged aquatic vegetation.
Brown trout	All Life Stages: Lakes, rivers, and streams.
Largemouth bass	Eggs and Larvae: Firm bottom of sand, mud, or gravel. Juveniles: Aquatic weeds, tree limbs or submerged logs or stumps. Adults: Submerged aquatic vegetation in lakes ponds or pools of creeks and rivers.
Pirate Perch	All Life Stages: Low current, deep water, densely vegetated areas with woody debris; underneath banks and within root masses.
White perch	All Life Stages: Freshwater ponds and rivers near the ocean; coastal and estuarine habitats.
Yellow perch	All Life Stages: Ponds, lakes, and the pools of creeks and slow flowing rivers in clear water near vegetation; can also be found in brackish water.
<p>SOURCES:</p> <p>Auster and Stuart 1986; Cargnelli et al. 1999a, 1999b, 1999c, 1999d; Collette and Klein-MacPhee 2002; Fahay et al. 1999a, 1999b; Fletcher et al. 2004; Malek et al. 2016; McBride et al. 2018; NOAA Fisheries 2017b; NEFSC 2004, 2020; NOAA 2020a, 2020b; NYSDEC 2008, 2020; Packer et al. 1999, 2003a, 2003b, 2003c; Pereira et al. 1999; Steimle et al. 1999a, 1999b, 1999c, 1999d, 1999e; USFWS 2020b, 2020c, 2020d, 2020e; Werner 2004</p>	

CONSTRUCTION AND OPERATIONS PLAN

Site Characterization and Assessment of Impacts – Biological Resources

Table 4.4.3-3 EFH Designations for Species in the SRWF, SRWEC, and Onshore Transmission Cable

Species ^{a/}	Life Stages within SRWF	Life Stages within SRWEC OCS	Life Stages within SRWEC NYS	Life Stages within Onshore Transmission Cable
New England Finfish				
American Plaice (<i>Hippoglossoides platessoides</i>)	-	Larvae	-	-
Atlantic Cod (<i>Gadus morhua</i>)	Egg, Larvae, Juvenile, Adult	Egg, Larvae, Juvenile, Adult	Egg, Larvae, Adult	-
Atlantic Herring (<i>Clupea harengus</i>)	Egg, Larvae, Juvenile, Adult	Larvae, Juvenile, Adult	Larvae, Juvenile, Adult	Juvenile, Adult
Atlantic Wolffish (<i>Anarhichas lupus</i>)	Egg, Larvae, Juvenile, Adult	-	-	-
Haddock (<i>Melanogrammus aeglefinus</i>)	Larvae, Juvenile	Larvae, Juvenile, Adult	Larvae	-
Monkfish (<i>Lophius americanus</i>)	Egg, Larvae, Juvenile, Adult	Egg, Larvae, Juvenile, Adult	Egg, Larvae, Adult	-
Ocean Pout (<i>Zoarces americanus</i>)	Egg, Juvenile, Adult	Egg, Juvenile, Adult	-	-
Offshore Hake (<i>Merluccius albidus</i>)	-	Larvae	-	-
Pollock (<i>Pollachius virens</i>)	Egg, Larvae, Juvenile	Egg, Larvae, Juvenile	Larvae, Juvenile	Juvenile
Red Hake (<i>Urophycis chuss</i>)	Egg, Larvae, Juvenile, Adult	Egg, Larvae, Juvenile, Adult	Egg, Larvae, Juvenile, Adult	-
Silver Hake (<i>Merluccius bilinearis</i>)	Egg, Larvae, Juvenile	Egg, Larvae, Juvenile, Adult	Egg, Larvae	-
White Hake (<i>Urophycis tenuis</i>)	Juvenile	Juvenile, Adult	Juvenile	-
Windowpane Flounder (<i>Scophthalmus aquosus</i>)	Egg, Larvae, Juvenile, Adult	Egg, Larvae, Juvenile, Adult	Egg, Larvae, Juvenile, Adult	Egg, Larvae, Juvenile, Adult
Winter Flounder (<i>Pseudopleuronectes americanus</i>)	Larvae, Juvenile, Adult	Larvae, Juvenile, Adult	Egg, Larvae, Juvenile, Adult	Egg, Larvae, Juvenile, Adult
Witch Flounder (<i>Glyptocephalus cynoglossus</i>)	Egg, Larvae, Adult	Egg, Larvae, Juvenile, Adult	Egg, Larvae, Adult	-
Yellowtail Flounder (<i>Limanda ferruginea</i>)	Egg, Larvae, Juvenile, Adult	Egg, Larvae, Juvenile, Adult	Egg, Larvae, Adult	-

CONSTRUCTION AND OPERATIONS PLAN

Site Characterization and Assessment of Impacts – Biological Resources

Species ^{a/}	Life Stages within SRWF	Life Stages within SRWEC OCS	Life Stages within SRWEC NYS	Life Stages within Onshore Transmission Cable
Mid-Atlantic Finfish				
Atlantic Butterfish (<i>Peprilus triacanthus</i>)	Egg, Larvae, Juvenile, Adult	Egg, Larvae, Juvenile, Adult	Juvenile, Adult	-
Atlantic Mackerel (<i>Scomber scombrus</i>)	Egg, Larvae, Juvenile, Adult	Egg, Larvae, Juvenile, Adult	Egg, Larvae, Juvenile, Adult	Egg, Larvae, Juvenile, Adult
Black Sea Bass (<i>Centropristis striata</i>)	Juvenile, Adult	Juvenile, Adult	Juvenile, Adult	Juvenile, Adult
Bluefish (<i>Pomatomus saltatrix</i>)	Egg, Larvae, Adult	Egg, Larvae, Juvenile, Adult	Juvenile, Adult	Juvenile, Adult
Scup (<i>Stenotomus chrysops</i>)	Juvenile, Adult	Juveniles, Adult	Juvenile, Adult	Juvenile, Adult
Summer Flounder (<i>Paralichthys dentatus</i>)	Egg, Larvae, Adult	Egg, Larvae, Juvenile, Adult	Egg, Larvae, Juvenile, Adult	Juvenile, Adult
Invertebrates^a				
Atlantic Sea Scallop (<i>Placopecten magellanicus</i>)	Egg, Larvae, Juvenile, Adult	Egg, Larvae, Juvenile, Adult	Egg, Larvae, Juvenile, Adult	-
Atlantic Surfclam (<i>Spisula solidissima</i>)	-	Juvenile, Adult	-	-
Longfin Inshore Squid (<i>Doryteuthis pealeii</i>)	Juvenile, Adult	Egg, Juvenile, Adult	Egg, Juvenile	Egg, Juvenile
Northern Shortfin Squid (<i>Illex illecebrosus</i>)	-	Adult	-	-
Ocean Quahog (<i>Arctica islandica</i>)	Juvenile, Adult	Juvenile, Adult	-	-
Highly Migratory Species				
Albacore Tuna (<i>Thunnus alalunga</i>)	Juvenile, Adult	Juvenile, Adult	Juvenile	-
Bluefin Tuna (<i>Thunnus thynnus</i>)	Juvenile, Adult	Juvenile, Adult	Juvenile	-
Skipjack Tuna (<i>Katsuwonus pelamis</i>)	Juvenile, Adult	Juvenile, Adult	Juvenile, Adult	-
Yellowfin Tuna (<i>Thunnus albacares</i>)	Juvenile, Adult	Juvenile, Adult	-	-

CONSTRUCTION AND OPERATIONS PLAN

Site Characterization and Assessment of Impacts – Biological Resources

Species ^{a/}	Life Stages within SRWF	Life Stages within SRWEC OCS	Life Stages within SRWEC NYS	Life Stages within Onshore Transmission Cable
Skates				
Barndoor Skate (<i>Dipturus laevis</i>)	Juvenile, Adult	Juvenile, Adult	-	-
Little Skate (<i>Leucoraja erinacea</i>)	Juvenile, Adult	Juvenile, Adult	Juvenile, Adult	Juvenile, Adult
Winter Skate (<i>Leucoraja ocellata</i>)	Juvenile, Adult	Juvenile, Adult	Juvenile, Adult	Juvenile, Adult
Sharks				
Basking Shark (<i>Cetorhinus maximus</i>)	Neonate, Juvenile, Adult	Neonate, Juvenile, Adult	-	-
Blue Shark (<i>Prionace glauca</i>)	Neonate, Juvenile, Adult	Neonate, Juvenile, Adult	-	-
Common Thresher Shark (<i>Alopias vulpinus</i>)	Neonate, Juvenile, Adult	Neonate, Juvenile, Adult	Neonate, Juvenile, Adult	-
Dusky Shark (<i>Carcharhinus obscurus</i>)	Neonate, Juvenile, Adult	Neonate, Juvenile, Adult	Neonate, Juvenile, Adult	-
Porbeagle Shark (<i>Lamna nasus</i>)	Neonate, Juvenile, Adult	Neonate, Juvenile, Adult	-	-
Sand Tiger Shark (<i>Carcharias taurus</i>)	Neonate, Juvenile	Neonate, Juvenile	Neonate, Juvenile	Neonate, Juvenile
Sandbar Shark (<i>Carcharhinus plumbeus</i>)	Juvenile, Adult	Neonate, Juvenile, Adult	Neonate, Juvenile, Adult	Juvenile, Adult
Shortfin Mako Shark (<i>Isurus oxyrinchus</i>)	Neonate, Juvenile, Adult	Neonate, Juvenile, Adult	-	-
Smoothhound Shark (<i>Mustelus canis</i>)	Neonate, Juvenile, Adult	Neonate, Juvenile, Adult	Neonate, Juvenile, Adult	Neonate, Juvenile, Adult
Spiny Dogfish (<i>Squalus acanthias</i>)	Sub-Adult Female, Adult Male, Adult Female	Juvenile, Sub-Adult Female, Sub-Adult Male, Adult Female, Adult Male	Sub-Adult Female, Adult Male	Sub-Adult Female, Adult Male,
Tiger Shark (<i>Galeocerdo cuvier</i>)	Juvenile, Adult	Juvenile, Adult	-	-
White Shark (<i>Carcharodon carcharias</i>)	Neonate, Juvenile, Adult	Neonate, Juvenile, Adult	Neonate, Juvenile, Adult	Neonate
NOTES: ^{a/} Invertebrates with EFH have been included in Table 4.4.3-3 to ensure a complete summary of all species with EFH in the Project Area; however, all additional discussion of invertebrates and their EFH can be found in Section 4.4.2 and Appendix N, respectively. Source: NOAA Fisheries 2020a.				

CONSTRUCTION AND OPERATIONS PLAN

Site Characterization and Assessment of Impacts – Biological Resources

Table 4.4.3-4 Common Prey Species of Juvenile and Adult Finfish Species

Species	Prey Species
Demersal/Benthic	
Atlantic Cod	Benthic invertebrates
Atlantic Halibut	Silver hake, sand lance, ocean pout, and alewife
Atlantic Sturgeon	Benthic invertebrates
Atlantic Wolffish	Mollusks and shellfish
Barndoor Skate	Polychaetes, gastropods, hydroids, spiny dogfish, alewife, Atlantic herring, menhaden, hakes, sculpins, cunner, tautog, sand lance, butterfish, flounders, razor clam, squids, and crabs
Black Sea Bass	Invertebrates and zooplankton
Cunner	Pipefish, mummichog, and invertebrates
Haddock	Amphipods
Little Skate	Sand lance, alewife, herring, cunner, silversides, tomcod, and silver hake
Monkfish	Sand lance and monkfish
Northern Searobin	Shrimp, crabs, amphipods, squid, bivalve mollusks, and segmented worms
Ocean Pout	Sand dollars
Pollock	Herring and crustaceans
Red Hake	Crustaceans
Sandbar Shark	Menhaden and crustaceans
Sand Tiger Shark	Small sharks, rays, squid, and lobster
Sand Lance	Plankton
Scup	Fish eggs and invertebrates
Sea Raven	Herring, lance, sculpins, tautog, silver hake, and both sculpin and sea-raven eggs
Silver hake	Crustaceans
Smoothhound Shark	Crustaceans, particularly lobsters
Spiny Dogfish	Squid and fish
Striped Bass	Menhaden, anchovy, spot, amphipods, and sand lance
Summer Flounder	Windowpane, winter flounder, northern pipefish, Atlantic menhaden, bay anchovy, red hake, silver hake, scup, Atlantic silverside, American sand lance, bluefish, weakfish, mummichog, rock crabs, squids, and shrimp
Tautog	Copepods and shellfish
Tilefish	Crabs, squid, shrimp, shelled mollusks, annelid worms, sea urchins, sea cucumbers, and sea anemones
White Hake	Polychaetes, shrimp, and other crustaceans
Windowpane Flounder	Invertebrates
Winter Flounder	Clams
Winter Skate	Smaller skates, eels, alewife, blueback herring, menhaden, smelt, sand lance, chub mackerel, butterfish, cunner, sculpins, silver hake, and tomcod
Witch Flounder	Polychaetes, crustaceans, and mollusks

CONSTRUCTION AND OPERATIONS PLAN

Site Characterization and Assessment of Impacts – Biological Resources

Species	Prey Species
Yellowtail Flounder	Invertebrates
Pelagic	
Albacore Tuna	Longfin and shortfin squid and crustaceans
Alewife	Herring, eels, sand lance, cunners, and alewife
American Eel	Small fish of many varieties, shrimp, crabs, lobsters, and smaller crustacea
American Shad	Various fish
Atlantic Bonito	Mackerels, menhaden, and sand lance
Atlantic Butterfish	Small fish, squid, and crustaceans
Atlantic Herring	Copepods
Atlantic Mackerel	Copepods and crustaceans
Atlantic Menhaden	Diatoms and crustaceans
Atlantic silverside	Zooplankton, copepods, shrimp, amphipods, young squid, worms, insects, and algae
Basking Shark	Small crustaceans
Bay anchovy	Mysid shrimp, copepods, small crustaceans and mollusks, and larval fish
Blueback Herring	Zooplankton
Bluefin Tuna	Herring and eels
Bluefish	Invertebrates and crustaceans
Blue Shark	Herring, mackerel, spiny dogfish, and various others
Common Thresher Shark	Pelagic fish and squid
Conger Eel	Butterfish, herring, eels, and invertebrates
Dusky Shark	Various pelagic fish
Porbeagle Shark	Fish and squids
Shortfin Mako Shark	Mackerels, tuna, and bonito
Skipjack Tuna	Pelagic fish and invertebrates
Spot	Bristle worms, mollusks, crustaceans, and plant and animal detritus
Tiger Shark	Fish and squids
Weakfish	Crabs, amphipods, mysid and decapod shrimps, squid, shelled mollusks, and annelid worms, menhaden, butterfish, herring, scup, anchovies, silversides, and mummichog
White Shark	Fish, rays, squid, other sharks, and marine mammals
Yellowfin Tuna	Large pelagic fish and squids
Freshwater (Carmans River)	
Black crappie	Planktonic crustaceans and small fish
Brook trout	Microcrustaceans, small insects, worms, leeches, crustaceans, insects, mollusks, small fish, and amphibians
Brown trout	Amphipods, mollusks, terrestrial insects, and fishes
Largemouth bass	Crustaceans, insects, fish, crayfish and frogs

CONSTRUCTION AND OPERATIONS PLAN

Site Characterization and Assessment of Impacts – Biological Resources

Species	Prey Species
Pirate Perch	Live mosquito larva, amphipods, glass shrimp, meal worms, earthworms, small fish, and dragonfly and stonefly larva
White perch	Zooplankton, minnows, crustaceans, and insects
Yellow perch	Zooplankton, insects, crustaceans, and small fish
SOURCES: Auster and Stuart 1986; Collette and Klein-MacPhee 2002; Knickel 2017; URI EDC 2017; NOAA Fisheries 2017b; NYSDEC 2008, 2020; Parker and Simco 1975; USFWS 2020b, 2020c, 2020d, 2020e; Werner 2004	

4.4.3.2 Potential Impacts

Section 4.2 summarizes all potential IPFs associated with construction, O&M, and decommissioning of the Project. This section focuses on those IPFs that have the potential to impact the finfish and EFH resources discussed above. IPFs that may result in direct or indirect impacts on finfish and EFH are depicted in Figure 4.4.3-2. Impacts will vary by habitat, species, and life stage, with some species/life stages being more vulnerable than others. All IPFs with potential to result in negligible or greater impacts on finfish and EFH are evaluated in this section. The analysis of impacts on finfish and EFH are discussed separately for the SRWF, SRWEC–OCS, SRWEC–NYS, and Onshore Facilities in the following sections. For the decommissioning phase of the Project, impacts are anticipated to be similar to, or less adverse than, those described for construction; therefore, impacts from decommissioning are not addressed separately in this section, with one exception. The Project's introduction of complex habitat in the offshore environment is expected to result in *beneficial* impacts, which would then be reversed at the time of decommissioning. This reversal of beneficial effects is discussed briefly below.

Impacts on benthic invertebrates, squid, and benthic habitat resources are described in Section 4.4.2 and Appendix M1. Supporting information regarding impacts on EFH are presented in further detail in Appendix N.

CONSTRUCTION AND OPERATIONS PLAN

Site Characterization and Assessment of Impacts – Biological Resources

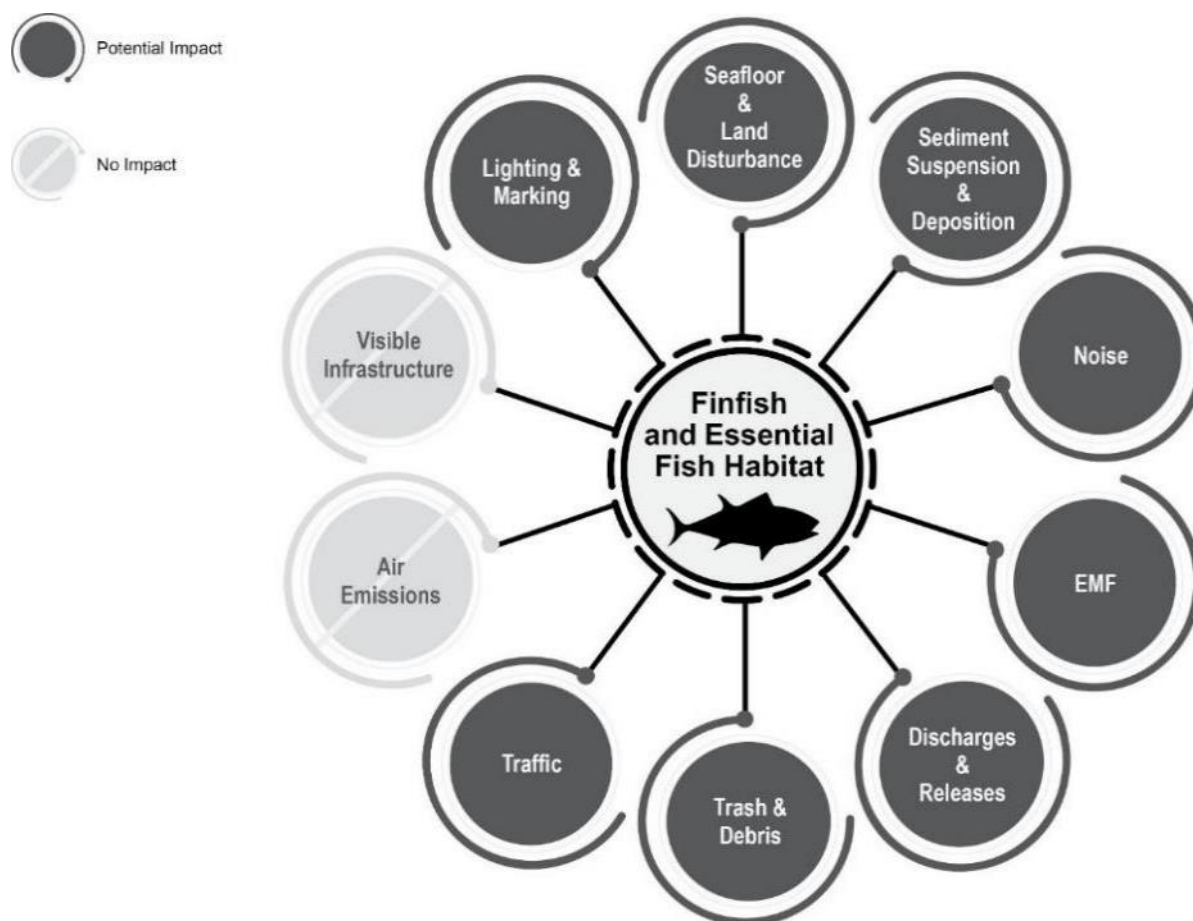

Figure 4.4.3-2 Impact-Producing Factors on Finfish and Essential Fish Habitat

Sunrise Wind Farm

During construction and O&M activities of the SRWF, impacts on finfish and EFH are expected to vary with each IPF. In general, impacts on pelagic life stages of finfish and species with designated EFH (EFH species) are expected to be less than for demersal or benthic life stages. Overall, during construction, O&M, and decommissioning of the SRWF, benthic/demersal life stages of finfish and EFH species may be exposed to direct impacts from seafloor disturbance, sediment suspension/deposition, noise associated with impact pile driving and/or vibratory pile driving of foundations, and indirect impacts from other IPFs, including trash and debris, traffic, and lighting and marking. Impacts on the pelagic life stages of finfish and EFH species may be direct for seafloor disturbance and noise from impact and/or vibratory pile driving and other construction/decommissioning activities, and indirect for other IPFs, including trash and debris, traffic, and lighting and marking. Impacts from discharges and releases may occur during construction but are very unlikely. Impacts from EMF may occur during O&M once the SRWF becomes operational and electricity is flowing through the cables but are very unlikely to have population-level effects.

CONSTRUCTION AND OPERATIONS PLAN

Site Characterization and Assessment of Impacts – Biological Resources

Potential, long-term impacts may result from the conversion of soft bottom habitat to hard bottom habitat associated with the foundations, scour protection, and secondary protection of the IAC. None of the IPFs are expected to result in population-level effects on finfish, EFH species, or listed species due to the limited scale and intensity of construction and O&M activities, the availability of similar habitat in the surrounding area, and the implementation of avoidance, minimization, and mitigation measures.

Construction

Seafloor and Land Disturbance

Impacts on finfish and EFH associated with seafloor preparation, pile driving, vessel anchoring, and cable installation will primarily be associated with species that have benthic/demersal early life stages (eggs and larvae) and later life stages (neonates, juveniles, and adults) (Appendix N) that prefer the types of habitats that will be disturbed by seafloor-disturbing activities.

Habitat alteration and seafloor disturbance from these activities could cause injury or mortality to benthic/demersal species, affect their habitat, and affect their spawning. Specifically, seafloor-disturbing activities could result in a small loss of spawning habitat for Atlantic cod, as studies completed in other regions suggest that cod often demonstrate spawning site fidelity, returning to the same fine-scale bathymetric locations year after year to spawn (Hernandez et al. 2013; Siceloff and Howell 2013). An active Atlantic cod winter spawning ground has been identified in a broad geographical area that includes Cox Ledge and surrounding locations (Zemeckis et al. 2014; Cadrin et al. 2020; Dean et al. 2020; Langan et al. 2020). There is currently a BOEM funded acoustic telemetry study to better understand the distribution and habitat use of spawning cod on and around Cox Ledge. Given the availability of similar surrounding habitat, Project activities are not expected to result in measurable impacts on spawning Atlantic cod.

Non-lethal impacts on finfish and EFH from seafloor preparation activities are expected to be short-term, as any effects will cease after seafloor preparation is completed in a given area and only a small portion of the available habitat in the area will be disturbed. Impacts on finfish and EFH species that have pelagic early and/or later life stages within the SRWF are expected to be limited as pelagic habitats will not be directly affected by seafloor preparation, aside from temporary seawater intake associated with CFE equipment associated with sand wave leveling. However, these species may temporarily vacate the area of disturbance and entrainment in construction equipment is not expected to result in population-level impacts.

Impacts on finfish and EFH associated with boulder clearance and related seafloor preparation activities are expected to be low. Boulders relocated during seafloor preparation will be in new locations and may be in new physical configurations in relation to other boulders.

Concerning these spatial and physical attributes, the boulders are not expected to return to pre-Project conditions. However, relatively rapid (< 1 year) recolonization of these boulders is expected (Guarinello et al. 2017) that will return these boulders to their pre-Project habitat function. Additionally, if relocation results in aggregations of boulders, these new features could serve as high value refuge habitat for juvenile lobster and fish that prefer structured habitat, as they may provide more complexity and opportunity for refuge than surrounding patchy habitat.

CONSTRUCTION AND OPERATIONS PLAN

Site Characterization and Assessment of Impacts – Biological Resources

Impacts on finfish and EFH associated with seafloor disturbance from impact pile driving and/or vibratory pile driving and installation of the foundations (WTG and OCS–DC) and scour protection are expected to be similar to those produced from seafloor preparation. Impact pile driving and/or vibratory pile driving, and foundation installation could crush benthic/demersal species, particularly eggs and larvae, but also less mobile, older life stages that do not vacate the area. Limited impacts on finfish and EFH are expected for pelagic species because they are not expected to be near the seafloor during work activities or subject to crushing or injury through placement of the piles and foundations.

Impacts on finfish and EFH associated with the IAC installation are expected to result in similar impacts as those for seafloor preparation, as the IAC will be installed in the same area that will have been disturbed during seafloor preparation. Because of the slow speed of the cable installation equipment and limited size of the impact area, it is expected that most mobile benthic/demersal and pelagic finfish will temporarily leave the area of disturbance; however, eggs, larvae, and other sessile or slower moving species may be subject to injury or mortality. Additionally, fish eggs and larvae (ichthyoplankton), as well as zooplankton, are expected to be entrained during jet plow installation of the IAC and CFE for targeted-area cable installation. During these activities, seawater is used to circulate through hydraulic motors and jets during installation. Although this seawater is released back into the ocean, species may be drawn into the water intake (entrained) and it is assumed that all entrained eggs, larvae, and zooplankton will be killed. These losses are expected to be very low, based on a previous assessment conducted for South Fork Wind, which found that the total estimated losses of zooplankton and ichthyoplankton from jet plow entrainment were less than 0.001 percent of the total zooplankton and ichthyoplankton abundance present in the Study Area, which encompassed a linearly buffered region of 15 km around the export cable and 25 km around the wind farm (INSPIRE Environmental 2018b). Only early life stages of fishes may be affected by the jet plow intake; later life stages would be capable of swimming away from the water intakes and are not expected to be entrained or impinged by the jet plow equipment.

If necessary, CFE or suction hopper dredging may be used for sand wave leveling during installation of the IAC. This method utilizes thrust to direct waterflow into sediment, creating liquefaction and subsequent dispersal. The CFE tool draws in seawater from the sides and then jets this water out from a vertical down pipe at a specified pressure and volume. The water withdrawal volumes are expected to be approximately 250 to 650 million gallons (946 to 2,460 million liters) for the jet-plow and approximately 191 to 516 million gallons (724 to 1,953 million liters) for CFE equipment. The down pipe is positioned over the cable alignment, enabling the stream of water to fluidize the sands around the cable, which allows the cable to settle into the trench under its own weight. During the process, the fluidized sand gets deposited within the local sand wave field. Local impact caused by entrainment of zooplankton and ichthyoplankton during hydraulic plowing or dredging can lead to mortality. These losses of eggs and larvae from CFE are expected to be similar to those observed from jet plow trenching and are not expected to result in population-level impacts.

CONSTRUCTION AND OPERATIONS PLAN

Site Characterization and Assessment of Impacts – Biological Resources

Immediately following impact-producing activities, finfish and EFH species are expected to move back into the area; however, in areas of sediment disturbance, demersal/benthic habitat recovery and benthic infaunal and epifaunal species abundances may take up to 1 to 3 years to recover to pre-impact levels (AKRF Inc. et al. 2012; Germano et al. 1994; Hirsch et al. 1978; Kenny and Rees 1994). Recolonization of sediments by epifaunal and infaunal species and the return of mobile fish and invertebrate species will allow this area to continue to serve as foraging habitat. Pelagic species/life stages may be indirectly affected by the temporary reduction of benthic forage species, but these impacts are expected to be small given the availability of similar habitats in the area. Other species may be attracted to the disruption and prey on dislodged benthic species or other species injured or flushed during seafloor preparation, IAC installation, and vessel anchoring activities.

Sediment Suspension and Deposition

Seafloor-disturbing activities will result in temporary increases in sediment suspension and deposition. Sand wave leveling may occur with either a suction hopper dredger or CFE. A suction hopper dredger includes a pump system that sucks up fluidized sand and deposits it within the local sand wave field. CFE uses water to clear loose sediment, creating soil liquefaction and subsequent dispersal.

Cable installation methodologies may include mechanical plowing, jet plowing, pre-cut dredging, mechanical cutting, or CFE. Mechanical plowing may pull a plow that simultaneously lays and buries the cable or a trench may be pre-cut in advance of cable burial activities. Jet plowing uses water jets to fluidize temporarily the soil to open a channel into which the cable is embedded. Pre-cut dredging is similar to pre-cut mechanical plowing where a trench is formed into which the cable is laid. Mechanical cutting cuts a narrow trench in the seafloor into which the cable sinks under its own weight or is pushed via a cable depressor.

Sediment transport modeling for the Project was performed using the PTM in the Surface-Water Modeling System. The PTM is a two-dimensional Lagrangian particle tracking model developed by the CIRP and the DOER at the USACE Research and Development Center. The model, inputs, and results are described in detail in Appendix H.

Several model simulations were run to evaluate the concentrations of suspended sediments, spatial extent and duration of sediment plumes, and the seafloor deposition resulting from cable burial, HDD exit pit dredging, and other Project activities. The grain size distributions used for modeling were based on grab samples from federal waters collected during field studies performed for the Project, and USGS sediment core data for NYS waters (USGS 2014). The sediment transport modeling results are summarized in Table 4.4.2-2.

For the SRWF IAC, two representative segments of installation by jet plow were simulated and the modeling results indicate that sediment plumes with TSS concentrations exceeding the ambient conditions by 100 mg/L could extend up to 3,346 ft (1,020 m) from the cable corridor centerline. The model estimated that the elevated TSS concentrations would be of short duration and are expected to return to ambient conditions within 0.5 hours following the cessation of cable burial activities. The modeling results also indicate that sedimentation from IAC burial is expected to exceed 0.4 in (10 mm) of deposition a maximum of 220 ft (67 m) from the cable centerline covering an area of 3.0 ha (7.4 acres) of the seafloor, and the TSS plume is predicted to be

CONSTRUCTION AND OPERATIONS PLAN

Site Characterization and Assessment of Impacts – Biological Resources

primarily contained within the lower portion of the water column, approximately 12.8 ft (3.9 m) above the seafloor.

Most marine species have some degree of tolerance to higher concentrations of suspended sediment because storms, currents, and other natural processes regularly result in increases in turbidity (MMS 2009). Direct impacts on benthic/demersal finfish and EFH could include mortality, injury, or temporary displacement of the organisms living on, in, or near the seafloor.

Sediment deposition on eggs or larvae may result in smothering, potentially resulting in mortality (MMS 2007). Demersal/benthic early life stages in or near the area of disturbance would be most affected, but these impacts are not expected to result in population-level effects. Pelagic species could also be affected but are expected to temporarily vacate the area to avoid the disturbance and pelagic habitat quality is expected to quickly return to pre-disturbance levels.

Noise

To evaluate the levels of underwater noise likely to be generated during construction, modeling was conducted that combined the outputs of source modeling with spatial and temporal environmental information (e.g., location, oceanographic conditions, and seabed type) to estimate acoustic sound fields (Appendix I1). Results of the acoustic modeling of impact pile driving activities are presented as single-strike ranges to a series of nominal SPL, SEL, and PK. Dual acoustic thresholds for physiological injury to fish are considered to be 206 dB PK and either 187 dB SEL (> 2 g fish weight) or 183 dB SEL (< 2 g fish weight). The behavioral threshold for fish is considered to be 150 dB SPL for all species (Greater Atlantic Regional Fisheries Office [GARFO] 2019).

Applying the thresholds for mortality and potential injury for fish, the radial distance associated with impact pile driving of monopile foundations are within approximately 505 ft (154 m) of the sound source. Radial distances from the piling source to injury thresholds for SEL are predicted to be a maximum of 8.4 mi (13.5 km) for large fish and 10.1 mi (16.3 km) for small fish with 10-dB attenuation mitigation measures implemented. The behavioral disturbance threshold for fish could be exceeded at radial distances of up to 10.4 mi (16.7 km). These zones would be constricted by land, and some of the pile driving noise is likely to be masked by ambient noise at distances shorter than those predicted by the noise modeling. Full modeling results are available in Appendix I1.

Potential impacts of noise on finfish and EFH resources can be categorized by hearing sensitivities (Hawkins et al. 2020). Invertebrates and the majority of fish species are relatively insensitive to sound energy, with sensitivities primarily to frequencies between 100 and 800 Hz; these species are also considered to be more sensitive to particle motion than sound pressure, though there are limited measurements related to particle motion. .

All fishes (including elasmobranchs) detect and use particle motion, even for those fishes that are also sensitive to sound pressure (Popper and Hawkins, 2019). Fishes that do not possess a swim bladder (sharks, mackerel, flatfish), as well as fishes with a swim bladder distant from the ear (salmon, tuna, most teleosts) are thought to primarily be sensitive to particle motion (Hawkins et al. 2020). Fishes with the swim bladder close to the ear (Atlantic cod, eels) or where the swim bladder is connected to the ear (herrings) are able to detect sound pressure as well as particle motion (Hawkins et al. 2020). In these finfish, the swim bladder and other gas-filled organs may act as a type of acoustic transformer, converting sound pressure into particle

CONSTRUCTION AND OPERATIONS PLAN

Site Characterization and Assessment of Impacts – Biological Resources

motion (Popper and Hawkins, 2018). The movement of these organs may indirectly stimulate the otolith structures such that fishes experience particle motion both from the noise source and from this indirect signal (Popper and Hawkins, 2018).

The federally listed Atlantic sturgeon, though not studied directly, is believed to be more sensitive to particle motion than sound pressure. If sturgeon are present in the SRWF during impact pile driving and/or vibratory pile driving activities, short-term, behavioral impacts could occur. However, a NOAA Fisheries Biological Opinion of offshore wind activities in the Atlantic WEAs concluded that sturgeon are not expected to occur in dense aggregations and occurrences will mostly consist of migrating individuals (NOAA Fisheries 2013a). Impacts on Atlantic sturgeon from impact pile driving and/or vibratory pile driving at the SRWF are expected to be limited considering they are an anadromous species that primarily utilize rivers, bays, estuaries, coastal, and shallow continental shelf waters. Atlantic sturgeon are discussed further in Appendix O.

For exposed species, noise from impact pile driving and/or vibratory pile driving may temporarily reduce habitat quality and cause mobile species to temporarily vacate the area (Hawkins et al. 2014; Neo et al. 2015). Some fish species may move away from the area before noise levels exceed the threshold for injury, but given the size of the potential zones of ensonification exceeding the behavioral disturbance threshold, harassment of individual fish is possible (Popper et al. 2014; Neo et al. 2015). The radial distances to SEL injury thresholds are a maximum of 8.4 mi (13.5 km) for large fish and 10.1 mi (16.3 km) for small fish, these SEL estimates assume fish remain stationary during pile driving and that this sound level occurs throughout the entire water column. In reality, fish would be moving around, which could, for some species, lessen the impact during pile driving, which will only occur for an approximately 4-hr period each day. As noted in impacts from seafloor disturbance, an active Atlantic cod winter spawning ground has been identified in a broad geographical area that includes Cox Ledge and surrounding locations (Zemeckis et al. 2014; Dean et al. 2020). In southern New England, cod spawn primarily from December through May (Dean et al. 2020; Langan et al. 2020). Atlantic cod produce “grunts” which may play a significant role in their reproductive behavior (Rowe and Hutchings 2004; Stanley et al. 2017). Noise from pile driving could potentially have an impact on cod reproduction by reducing the efficiency of these vocalizations (Stanley et al. 2017). If pile driving is suspended during the winter months to avoid impacts to North Atlantic right whales, this will also mitigate potential noise impacts on spawning Atlantic cod. In conclusion, impact pile driving and/or vibratory pile driving is expected to result in short-term impacts on finfish and EFH for both pelagic and demersal life stages, as once pile driving is completed, the habitat suitability is expected to return to pre-pile driving conditions.

Short-term and short-range impacts on finfish and EFH could also occur due to geophysical surveys, vessel noise, construction equipment noise, and/or aircraft noise. Limited research has been conducted on underwater noise from mechanical/hydro-jet plows. Generally, the noise from this equipment is expected to be masked by louder sounds from vessels. Also, as most noise generated by these pieces of equipment will be below the sediment surface and associated with the high-pressure jets, noise levels are not expected to result in injury or mortality to finfish and EFH species but may cause finfish to temporarily vacate the area. The duration of noise at a given location will be short, as the installation vessel will only be present for a short period at any given location along the cable route.

CONSTRUCTION AND OPERATIONS PLAN

Site Characterization and Assessment of Impacts – Biological Resources

Short-term, localized geophysical surveys during the construction period may include the use of multi-beam echosounders, side-scan sonars, shallow penetration sub-bottom profilers, medium penetration sub-bottom profilers, and marine magnetometers. The survey equipment to be employed will be equivalent to the equipment utilized during survey campaigns associated with Lease Area OCS–A 0500 conducted in 2016, 2017, 2018, 2019, and 2020 and with Lease Area OCS–A 04876 conducted in 2018, 2019 and 2020 (CSA Ocean Sciences Inc. 2020) and is not expected to result in measurable impacts on finfish and EFH.

Helicopters will be used for crew transfers between the SRWF and shore. Underwater noise associated with helicopters is generally brief as compared with the duration of audibility in the air (Richardson et al. 1995). The noise generated by aircraft will be similar to the range of noise from existing aircraft traffic in the region and is not expected to substantially affect the existing underwater noise environment.

Vessel noise may also cause finfish to temporarily vacate the area. Vessel sound source levels have been shown to cause several different effects, the most common of which are behavioral responses, including avoidance, alteration of swimming speed and direction, and alteration of schooling behavior (Vabø et al. 2002; Handegard and Tjøstheim 2005; Sarà et al. 2007; Becker et al. 2013; Slabbekoorn et al. 2019). These studies also demonstrated that the behavioral changes generally were temporary or that fish habituated to the noises. Finfish in the vicinity of construction vessels may be affected by vessel noise but the duration of the disturbance will occur over a very short period at any given location. Noise from vessel traffic is also expected to be similar to existing background vessel traffic noise in the area.

Discharges and Releases

Project-related marine vessels operating during construction will be required to comply with regulatory requirements for management of onboard fluids and fuels, including prevention and control of discharges. Trained, licensed vessel operators will adhere to navigational rules and regulations, and vessels will be equipped with spill containment and cleanup materials. Additionally, Sunrise Wind will comply with applicable international (IMO MARPOL), federal (USCG), and state (NY) regulations and standards for reporting treatment and disposal of solid and liquid wastes generated during all phases of the Project. As described in Appendix E1, some liquid wastes will be permitted as discharge into marine waters (i.e., domestic water, deck drainage, treated sump drainage, uncontaminated ballast water, and uncontaminated bilge water); these are not expected to pose an adverse impact to marine resources as they will quickly disperse, dilute, and biodegrade (BOEM 2013).

All vessels will similarly comply with USCG standards regarding ballast and bilge water management. Liquid wastes from vessels (including sewage, chemicals, solvents, and oils and greases from equipment) will be properly stored, and disposal will occur at a licensed receiving facility. As required by 30 CFR 585.626, chemicals to be utilized during the Project are provided in Appendix E1, and in Table 3.3.1-2 and Table 3.3.6-2. Any unanticipated discharges or releases are expected to result in minimal, temporary impacts; activities are heavily regulated and unpermitted discharges are considered accidental events that are unlikely to occur. In the unlikely event that a reportable spill were to occur, the National Response Center would be notified, followed by the EPA, BOEM, and USCG, as outlined in Appendix E1.

CONSTRUCTION AND OPERATIONS PLAN

Site Characterization and Assessment of Impacts – Biological Resources

Trash and Debris

Any active vessel operating within a marine environment has the potential to create trash and debris. However, the discharge or disposal of solid debris into offshore waters from OCS structures and vessels is prohibited by BOEM (30 CFR 250.300) and the USCG (MARPOL, Annex V, Pub. L. 100-220 [101 Stat. 1458]). In accordance with applicable federal, state, and local laws, Sunrise Wind will implement comprehensive measures prior to and during Project construction activities to avoid, minimize, and mitigate impacts related to trash and debris disposal. All trash and debris will be properly stored on vessels for later disposal of on land at an appropriate facility per 30 CFR 585.626(b)(9). Trash and debris will be contained on vessels and offloaded at port or construction staging areas. Food waste that has been ground and can pass through a 25-mm mesh screen may be disposed of according to 33 CFR 151.51-77. All other trash and debris returned to shore will be disposed of or recycled at licensed waste management and/or recycling facilities. Disposal of any other form of solid waste or debris in the water will be prohibited, and good housekeeping practices will be implemented to minimize trash and debris in vessel work areas. These practices will include orderly storage of tools, equipment, and materials, as well as proper waste collection, storage, and disposal to keep work areas clean and minimize potential environmental impacts. With proper waste management procedures, the potential for trash or debris to be inadvertently left overboard or introduced into the marine environment is not anticipated.

Traffic

Impacts associated with vessel traffic during SRWF construction and decommissioning are identified under the Seafloor Disturbance, Noise, Sediment Suspension and Deposition, and Lighting sections.

For the federally listed Atlantic sturgeon, vessel strikes are an additional stressor associated with traffic. The factors contributing to the risk of Atlantic sturgeon vessel strikes are currently unknown, but may be related to the size and speed of vessels, navigational clearance (i.e., depth of water and draft of vessels), and the behavior of Atlantic sturgeon (e.g., foraging, migrating) in areas where vessels are operating (NOAA Fisheries 2013b). It is important to note that Atlantic sturgeon vessel strikes have only been identified as a significant concern in the Delaware and James Rivers. Studies suggest that there may be unique geographic features of the Delaware and James Rivers (e.g., narrow migration corridors combined with shallow/narrow river channels) that increase the risk of interactions between vessels and Atlantic sturgeon (NOAA Fisheries 2013b). Similarly, the giant manta ray may occur on the rare occasion within the SRWF (as detailed in Appendix O). Giant manta rays often spend time at the surface of the water to bask or feed, which makes them susceptible to vessel strikes (McGregor et al. 2019).

Construction of the SRWF would result in a minor increase in vessel traffic, but most vessels would be slow-moving, and the effect would be small relative to existing traffic in the region. Additionally, because large numbers of Atlantic sturgeon and/or giant manta rays are not expected to be present in areas of vessel activity, the likelihood of an interaction with a Project vessel is very low. For these reasons, vessel traffic associated with the SRWF is not expected to negatively affect Atlantic sturgeon or giant manta rays. Additional discussion of potential impacts on Atlantic sturgeon is provided in Appendix O.

CONSTRUCTION AND OPERATIONS PLAN

Site Characterization and Assessment of Impacts – Biological Resources

Lighting and Marking

Artificial lighting during construction at the SRWF will be associated with navigational and deck lighting on vessels and partially installed structures from dusk to dawn in accordance with USCG regulations. The response of finfish species to artificial lights is highly variable and depends on several factors such as the species, life stage, and the intensity of the light. Small organisms are often attracted to lights, which in turn attract larger predators to feed on the prey aggregations. Other species may avoid artificially illuminated areas. Artificial lighting may disrupt the diel vertical migration patterns of fish and this may affect species richness and community composition (Nightingale et al. 2006; Phipps 2001). It could also increase the risk of predation and disruption of predator/prey interactions and result in the loss of opportunity for dark-adapted behaviors including foraging and migration (Orr et al. 2013). However, artificial lighting associated with construction would be temporary and limited relative to the surrounding areas.

Additionally, lighting will be limited to the minimum necessary to ensure safety and to comply with applicable regulations and no underwater lighting is proposed. Artificial lighting is not expected to result in measurable impacts on finfish and EFH.

Operations and Maintenance

Seafloor and Land Disturbance

Seafloor disturbance during O&M of the SRWF may occur during non-routine maintenance of bottom-founded infrastructure (e.g., foundations, scour protection, cable protection) and associated vessel anchoring activities. During O&M, anchoring will be limited to vessels required to be onsite for an extended duration. These maintenance activities are expected to result in similar impacts on finfish and EFH as those discussed for the construction phase, although the extent of disturbance would be limited to specific areas.

Once constructed, the SRWF will result in localized changes to seafloor topography and hydrodynamics because of the presence of foundations, scour protection, and cable protection. In previous assessments, offshore structures have not been shown to change the strength or direction of regional oceanic currents that transport eggs and larvae of marine fishes (RI CRMC 2010; DONG Energy et al. 2006). Larval recruitment of finfish and EFH species from the water column is not anticipated to be affected by the SRWF structures because the vertical foundations represent a miniscule surface area within the surrounding waters, and recruitment is generally influenced by numerous environmental signals other than the presence of physical structure (including stage of larval development, temperature, prey availability, and chemical odor of conspecifics) (McManus et al. 2018; Pineda et al. 2007). Foundations have been hypothesized as serving as attachment sites for eggs of squid and herrings in the North Sea, but data so far are lacking (Vandendriessche et al. 2016). Planktonic life stages of finfish and EFH species would not be directly affected by the introduction of foundations and scour protection. The seafloor overlaying the majority of buried IAC (where cable protection will not exist) is expected to return to pre-construction conditions over time and no long-term changes to sediment mobility and depositional patterns are expected. BOEM is funding an additional study to assess how wind energy facilities may affect local and regional physical oceanographic processes, including circulation and sediment, nutrient, and larval transport (BOEM 2020).

CONSTRUCTION AND OPERATIONS PLAN

Site Characterization and Assessment of Impacts – Biological Resources

Affiliates of Sunrise Wind have provided BOEM with ocean current data from several measurement campaigns within their respective lease areas to help support this study and achieve greater modeling accuracy and study reliability.

The presence of the foundations, associated scour protection, and cable protection may result in both adverse and beneficial long-term impacts on finfish and EFH due to conversion of habitat from primarily soft bottom to hard bottom in the immediate vicinity of the structures. Habitat conversion is expected to cause a shift in species assemblages towards those found in rocky reef/rock outcrop habitat; this is known as the “reef effect” (Wilhelmsson et al. 2006; Reubens et al. 2013). This effect is also well known from other anthropogenic structures in the sea, such as oil platforms, artificial reefs, piers, and shipwrecks (Claudet and Pelletier 2004; Wilhelmsson et al. 2006; Seaman 2007; Langhamer and Wilhelmsson 2009; Glarou et al. 2020).

The use of gravel, boulders, and/or concrete mats will create new hard substrate, and this substrate is expected to be initially colonized by barnacles, tube-forming species, hydroids, and other fouling species found on existing hard bottom habitat in the region. Mobile organisms, such as lobsters and crabs, may also be attracted to and occur in and around the foundation in higher numbers than surrounding areas. Monopiles attract a range of attached epifauna and epiflora, including barnacles and filamentous algae (Petersen and Malm 2006).

Jacket foundations (for the OCS–DC) provide a more complex structure than monopile foundations and may increase habitat complexity through more suitable fouling surfaces and increased protection from predators (MMS 2009). As these foundations extend from below the seafloor to above the surface of the water, there is expected to be a zonation of macroalgae from deeper growing red foliose algae and calcareous algae, to kelps and other species, including those that may grow in subtidal, intertidal, and splash zone areas. Foundations and cable protection typically also have crevices that increase structural complexity of the area and attract finfish and invertebrate species seeking shelter.

Finfish and EFH species that have life stages associated with soft bottom habitats may experience impacts, as available habitat will be slightly reduced. Finfish and EFH species and life stages that inhabit hard bottom habitats may experience a beneficial effect, depending on the quality of the habitat created by the foundations and scour protection, and the quality of the benthic community that colonizes that habitat. Overall, habitat alteration is expected to cause minimal impacts because similar soft and hard bottom habitats are already present in and around the SRWF (Appendix M1), and the conversion of a relatively small area of habitat is unlikely to result in substantial effects, as any “reef effect” observed will be limited to the immediate vicinity of the individual structures.

Sediment Suspension and Deposition

Increases in sediment suspension and deposition during the O&M phase will result from vessel anchoring and non-routine maintenance activities that require exposing the IAC. Impacts on finfish and EFH resulting from sediment suspension and deposition during the O&M phase are expected to be similar to those discussed for the construction phase, but on a more limited spatial scale.

CONSTRUCTION AND OPERATIONS PLAN

Site Characterization and Assessment of Impacts – Biological Resources

Noise

Impacts on finfish and EFH from ship and aircraft noise during O&M of the SRWF are expected to be similar to those discussed for the construction phase, though much lesser in intensity and spatial extent. The underwater noise generated by vessels and aircraft will be similar to the range of noise from existing vessel and aircraft traffic in the region and are not expected to substantially affect the existing underwater noise environment.

The underwater noise levels produced by operating WTGs are expected to be within the hearing ranges of fish, including Atlantic sturgeon. Low-frequency sounds, generally below 700 Hz, are produced when the blades are spinning, at source levels of 80 to 150 dB re 1 μ Pa (Kikuchi 2010; Betke et al. 2004). Noise levels from operation of the WTGs are not expected to result in injury or mortality, and it is unlikely that most fish will be exposed to sound levels above background noise levels in the ocean, but if they are, finfish may become habituated to the operational noise (Thomsen et al. 2006; Bergström et al. 2014). Lindeboom et al. (2011) found no difference in the residency times of juvenile cod around monopiles between periods of WTG operation or when WTGs were out-of-order. This study also found that sand eels did not avoid the wind farm. In a similar study, the abundance of cod, eel, shorthorn sculpin (*Myoxocephalus scorpius*), and goldsinny wrasse (*Ctenolabrus rupestris*) were found to be higher near WTGs, suggesting that potential noise impacts from operation did not override the attraction of these species to the artificial reef habitat (Bergström et al. 2013). Based on the available literature, operational noise from the WTGs is expected to have insignificant impacts on finfish, EFH, and Atlantic sturgeon. Additional discussion of potential impacts on Atlantic sturgeon is provided in Appendix O.

Short-term, localized impacts from geophysical surveys during O&M may occur from the use of multi-beam echosounders, side-scan sonars, shallow penetration sub-bottom profilers, medium penetration sub-bottom profilers and marine magnetometers. The survey equipment to be employed will be equivalent to the equipment utilized during survey campaigns associated with Lease Area OCS-A 0500 conducted in 2016, 2017, 2018, 2019, and 2020 and with Lease Area OCS-A 0487 conducted in 2019 and 2020 (CSA Ocean Sciences Inc. 2020), and are not expected to result in measurable impacts on finfish and EFH.

Electric and Magnetic Fields

Once energized, the Project cables will produce a magnetic field and an induced electric field that will decrease in strength rapidly with distance. The OCS-DC is too far above sea level to be a source of EMF in the marine environment; however, several cables come into this structure and will be sources of EMF when energized. The following discussion focuses on potential impacts from AC EMF emissions of the IAC. DC EMF from the SRWEC is discussed in later sections.

The IAC will be shielded and, where feasible, buried beneath the seafloor and will otherwise be protected. Submarine transmission cables do not directly emit electrical fields into surrounding areas but are surrounded by magnetic fields that can cause induced electrical fields in the surrounding medium or in nearby species (Snyder et al. 2019). Exposure to EMF could be short- or long-term, depending on the mobility and behavior of the species/life stage.

CONSTRUCTION AND OPERATIONS PLAN

Site Characterization and Assessment of Impacts – Biological Resources

A modeling analysis of the magnetic fields and induced electric fields anticipated to be produced during operation of the IAC was performed and results are included in Appendix J1. Though multiple cables come into the OCS–DC, the cables are sufficiently distributed that the level of EMF emissions at the structure is similar to the individual cables themselves (see Appendix J1 for more details). Appendix J1 also summarizes data from field studies conducted to assess impacts of EMF on marine organisms. These studies constitute the best source of evidence to assess the potential impacts on finfish and invertebrate behavior or distribution in the presence of energized cables.

The available laboratory-generated research regarding the effects of 50- or 60-Hz AC power sources on fish behavior do not indicate that produced fields will have adverse effects on magnetosensitive and electrosensitive species. Controlled laboratory studies conducted with eel and salmon (Richardson et al. 1976; Armstrong et al. 2015; Orpwood et al. 2015) support the conclusion that EMF produced by 50 to 75 Hz AC cables do not alter the behavior of magnetosensitive fish species, indicating that EMF is not easily detected by magnetosensitive migratory fish species. Laboratory studies assessing the EMF detection abilities of elasmobranchs indicate that their EMF detection ability decreases as the source frequency increases over 20 Hz and suggest that elasmobranchs are unlikely to easily detect electric fields produced by 50/60 Hz power sources (Andrianov et al. 1984; Kempster et al. 2013). In a laboratory study, demersal catshark were exposed to magnetic fields produced by a 50-Hz AC source and did not exhibit any significant behavioral changes (Orr 2016). Field studies have also concluded that energized power cables neither attract nor repel elasmobranchs (Love et al. 2016). Based on the available information, EMF produced by 50/60 Hz power sources such as the IAC is unlikely to be detected by elasmobranchs and is unlikely to cause changes in elasmobranch behavior or distribution.

Love et al. (2016) conducted a series of surveys between 2012 and 2014 to track fish populations at both energized and unenergized AC cables off the California coast. These studies were designed to assess whether EMF produced by the energized cable had any in situ effects on the distribution of marine species. Over three years of observations, no differences in fish communities at energized and unenergized cable sites were noted, indicating that EMF had no effect on fish distributions, although the physical structure of the unburied cables did create a “reef effect” (Love et al. 2016). Additionally, multiple fish surveys have been conducted at existing offshore windfarm sites. Results from these studies strongly indicate that operating windfarms and cables do not adversely affect the distributions of resident fish populations.

Nearly 10 years of pre- and post-operational data from the Horns Rev Offshore Wind Farm site near Denmark indicate “no general significant changes in the abundance or distribution patterns of pelagic and demersal fish” (Leonhard et al. 2011), including species similar to those expected to inhabit the SRWF. Researchers did note an increase in fish species associated with hard ground and vertical features, especially around WTG footings (Leonhard et al. 2011).

CONSTRUCTION AND OPERATIONS PLAN

Site Characterization and Assessment of Impacts – Biological Resources

Compared to fish and elasmobranchs, relatively little is known about the response of marine invertebrates to EMF (Albert et al. 2020). Field surveys on the behavior of large crab species and lobster at submarine cable sites (Love et al. 2017; Hutchison et al. 2018) indicate that the Project's calculated magnetic-field levels are not likely to impact the distribution and movement of large epibenthic crustaceans. Ancillary data and observations from these field studies also suggest that cephalopod behavior is similarly unaffected by the presence of 60-Hz AC cables. A synthesis paper on the current understanding of potential impacts of EMF on invertebrates concludes that while some studies have shown changes in individuals during laboratory studies, not enough information is available to determine how those changes may extend to the population or community level or ecological processes (Albert et al. 2020). Based on the modeling results and existing evidence, the EMF associated with the cables will be below the detection capability of most invertebrate species and are unlikely to result in measurable impacts on EFH invertebrate species.

Based on the modeling results and existing evidence, EMF associated with the IAC are not expected to adversely affect the populations or distributions of finfish or EFH species in the SRWF. These conclusions are consistent with the findings of a previous comprehensive review of the ecological impacts of marine renewable energy projects, where it was determined that there has been no evidence demonstrating that EMF at the levels expected from marine renewable energy projects will cause an effect (negative or positive) on any species (Copping et al. 2016). Moreover, a 2019 BOEM report that assessed the potential for AC EMF from offshore wind facilities to affect marine populations concluded that, for the southern New England area, no negative effects are expected for populations of key commercial and recreational fish species (Snyder et al. 2019). Based on this information, it is not expected that finfish and EFH will be measurably affected by AC EMF emissions from the IAC.

Discharges and Releases

Impacts from accidental discharges and releases during O&M are expected to be similar to, but of lesser likelihood than during construction, as there will be fewer Project-related marine vessels during this phase, and regulatory requirements and preventative measures will still apply. Unpermitted discharges or releases are considered accidental events, and in their unlikely occurrence, these are expected to result in minimal, temporary impacts. Permitted discharges are not expected to pose an adverse impact to marine resources as they will quickly disperse, dilute, and biodegrade (BOEM 2013).

Seawater cooling will be needed for the OCS-DC (Section 3.3.6.1). During operation, the OCS-DC will require continuous cooling water withdrawals and subsequent discharge of heated effluent back to the receiving waters. The maximum DIF and discharge volume is 8.1 million gallons per day with AIF and discharge volumes that are dependent on ambient source water temperature and facility output. Preliminary hydrodynamic modelling indicates that there will be some highly localized increases in water temperature in the immediate vicinity of the discharge location of the OCS-DC. The design, configuration, and operation of the CWIS for the OCS-DC will be permitted as part of an individual NPDES permit and additional details will be included in the permit application submitted to the EPA. This will include final results of the hydrodynamic modelling.

CONSTRUCTION AND OPERATIONS PLAN

Site Characterization and Assessment of Impacts – Biological Resources

Trash and Debris

Impacts from marine disposal of trash and debris during O&M are expected to be similar to, but of lesser likelihood than during construction, as there will be fewer Project-related marine vessels during this phase, and regulatory requirements and preventative measures will still apply. The unanticipated marine disposal of trash and debris is considered an unpermitted, accidental event, and containment and good housekeeping practices will be implemented to minimize the potential.

Traffic

Impacts associated with vessel traffic during SRWF O&M are identified under the Seafloor Disturbance, Noise, Sediment Suspension and Deposition, and Lighting sections.

As discussed for the construction phase, vessel strikes are an additional stressor that could affect Atlantic sturgeon. O&M of the SRWF would result in a minor increase in vessel traffic, but most vessels would be slow-moving, and the effect would be small relative to existing traffic in the region. Additionally, because large numbers of Atlantic sturgeon are not expected to be present in areas of vessel activity, the likelihood of an interaction with a Project vessel is very low. For these reasons, vessel traffic is not expected to negatively affect Atlantic sturgeon. Additional discussion of potential impacts on Atlantic sturgeon is provided in Appendix O.

Lighting and Marking

Artificial lighting during O&M will be associated with vessels, the WTGs, and the OCS–DC for operational safety and security purposes. As discussed for the construction phase, the response of fish species to artificial lights is highly variable and depends on several factors such as the species, life stage, and the intensity of the light. Small organisms are often attracted to lights, which in turn attract larger predators to feed on the prey aggregations.

Other species may avoid artificially illuminated areas. However, lighting will be limited to the minimum necessary to ensure safety and to comply with applicable regulations. Because of the limited area that will have artificial lighting relative to the surrounding areas, and because no underwater lighting is proposed, impacts on finfish and EFH are expected to be insignificant.

Decommissioning

At the end of the Project's operational life, structures will be decommissioned in accordance with a detailed Project decommissioning plan that will be developed in compliance with applicable laws, regulations, and BMPs at that time. All facilities will need to be removed to a depth of 15 ft (4.6 m) below the mudline, unless otherwise authorized by BOEM (30 CFR § 585.910(a)). This plan will account for changing circumstances during the operational phase of the Project and will reflect new discoveries particularly in the areas of marine environment, technological change, and any relevant amended legislation. Absent permission from BOEM, Sunrise Wind will complete decommissioning within two years of termination of the Lease.

If the man-made structures are to be removed at the end of the Project's operational life, as currently prescribed, this will reverse the expected beneficial impacts on finfish and EFH resources through the introduction of complex habitat. Over time, the disturbed area is expected to revert to pre-construction conditions, which would result in a beneficial impact for species and life stages that inhabit soft bottom habitats.

CONSTRUCTION AND OPERATIONS PLAN

Site Characterization and Assessment of Impacts – Biological Resources

Overall, habitat alteration from decommissioning is expected to cause minimal impacts because similar soft and hard bottom habitats are already present in and around the SRWF and SRWEC (Appendices M1, M2, and M3).

A recent review on the impacts of decommissioning man-made structures provides the case for considering alternatives to a mandated complete removal of all man-made structures. The paper emphasizes the potential importance of man-made submerged structures as complex habitats potentially supporting a rich localized food web (Fortune and Paterson 2020). Benthic habitat and finfish monitoring at the foundations and the surrounding area will document the direct realized effects of these novel hard surfaces on finfish and EFH resources. Documenting the established epifaunal community that will inhabit the foundations, as well as the infaunal community at the base of these structures, will provide information on the habitat value to finfish as potential EFH. The data gathered from these post-construction benthic and finfish surveys will be used to inform decommissioning strategies in the future.

Sunrise Wind Export Cable – OCS

Construction

Seafloor and Land Disturbance

Direct impacts on finfish and EFH from seafloor preparation, SRWEC–OCS installation, and vessel anchoring are expected to be similar to those discussed for construction of the SRWF, though less boulders are present along the cable route than in the SRWF. Seafloor preparation, SRWEC–OCS installation, and vessel anchoring are expected to have minimal impacts on finfish and EFH species that have pelagic early or later life stages.

As described in the construction discussion for the SRWF, fish eggs and larvae (ichthyoplankton), as well as zooplankton, are expected to be entrained and killed during jet plow embedment of the SRWEC–OCS and CFE associated with sand wave leveling. These losses are expected to be very low based on a previous assessment conducted for the South Fork Wind Farm, which found that the total estimated losses of zooplankton and ichthyoplankton from jet plow entrainment were less than 0.001 percent of the total zooplankton and ichthyoplankton abundance present in the Study Area, which encompassed a linearly buffered region of 15 km around the export cable and 25 km around the wind farm (INSPIRE Environmental 2018b).

As discussed for the construction of the SRWF, in areas of sediment disturbance, benthic habitat recovery and benthic infaunal and epifaunal species abundances may take up to 1 to 3 years to recover to pre-impact levels, based on the results of a number of studies on benthic recovery (e.g., AKRF, Inc. et al. 2012; Germano et al. 1994; Hirsch et al. 1978; Kenny and Rees 1994). Recolonization of sediments by epifaunal and infaunal species and the return of mobile fish and invertebrate species will allow this area to continue to serve as foraging habitat for finfish and EFH species. Pelagic species/life stages may be indirectly affected by the temporary reduction of benthic forage species, but these impacts are expected to be insignificant given the availability of similar habitats in the area. Other species may be attracted to the disruption and prey on dislodged benthic species or other species injured or flushed during seafloor preparation, SRWEC–OCS installation, and vessel anchoring activities.

CONSTRUCTION AND OPERATIONS PLAN

Site Characterization and Assessment of Impacts – Biological Resources

Sediment Suspension and Deposition

Seafloor-disturbing activities associated with the SRWEC–OCS installation will result in temporary increases in sediment suspension and deposition, similar to construction of the SRWF discussed above. Sediment transport modeling for the Project was performed by using the PTM to evaluate the concentrations of suspended sediments, spatial extent and duration of sediment plumes, and the seafloor deposition resulting from construction activities. The sediment transport modeling results are summarized in Table 4.4.2-2. The model, inputs, and results are described in detail in Appendix H.

During installation of the SRWEC–OCS, modeling results indicate that sediment plumes with TSS concentrations exceeding the ambient conditions by 100 mg/L could extend up to 2,969 ft (905 m) from the cable corridor centerline in federal waters. The model estimated that the elevated TSS concentrations would be of short duration and expected to return to ambient conditions within 0.4 hours following the cessation of cable burial activities. Sedimentation from SRWEC–OCS burial is predicted to exceed 0.4 in (10 mm) of deposition up to 791 ft (241 m) from the cable corridor centerline. This thickness of sedimentation is expected to cover approximately 832.3 acres (3,368,000 m²) in federal waters, and the TSS plume is predicted to be primarily contained within the lower portion of the water column, approximately 9.8 ft (3.0 m) above the seafloor. Direct impacts on finfish and EFH from sediment suspension and deposition are expected to be similar to those discussed for construction of the SRWF, with greater impacts on sessile and slow-moving benthic species/life stages compared to mobile and pelagic species/life stages.

Noise

The direct impacts on finfish and EFH from noise associated with geophysical surveys, vessels, construction equipment, and aircraft during construction of the SRWEC–OCS are expected to be similar to those discussed for the construction phase of the SRWF.

Discharges and Releases

The potential for exposure and adverse impacts from routine and non-routine discharges and releases will be similar to those identified for the SRWF.

Trash and Debris

The potential for exposure and adverse impacts from routine and non-routine activities resulting in trash and debris will be similar to those identified for the SRWF. Depending on the type of trash or debris, fish could become entangled or ingest foreign materials, causing injury or mortality. However, with proper waste management procedures, the potential for trash or debris to be inadvertently left overboard or introduced into the marine environment is not anticipated.

Traffic

Impacts associated with vessel traffic during SRWEC–OCS construction are identified under the Seafloor Disturbance, Noise, Sediment Suspension and Deposition, and Lighting sections. Potential impacts on Atlantic sturgeon are also expected to be insignificant and similar to construction of the SRWF. Additional discussion of potential impacts on Atlantic sturgeon is provided in Appendix O.

CONSTRUCTION AND OPERATIONS PLAN

Site Characterization and Assessment of Impacts – Biological Resources

Lighting and Marking

Impacts on finfish and EFH from artificial lighting during SRWEC–OCS construction are expected to be insignificant and similar to the impacts from artificial lighting for construction of the SRWF.

Operations and Maintenance

Seafloor and Land Disturbance

Minimal impacts on finfish and EFH are expected from operation of the SRWEC–OCS, as it will be buried beneath the seabed where feasible and will otherwise be protected. Seafloor disturbance during O&M of the SRWEC–OCS will be limited to non-routine maintenance that may require uncovering and reburial of the cables, as well as maintenance of cable protection where present. These maintenance activities and associated vessel anchoring are expected to result in similar direct impacts on finfish and EFH as those discussed for construction, although the extent of disturbance would be limited to specific areas along the SRWEC–OCS route.

Cable protection (e.g., concrete mattresses or rock placement) may be placed in select areas along the SRWEC–OCS. The introduction of engineered concrete mattresses or rock to areas of the seafloor can cause local disruptions to circulation, currents, and natural sediment transport patterns, though these impacts are expected to be insignificant given the miniscule surface area associated with the cable protection compared to the surrounding waters. Under normal circumstances, these segments of the SRWEC–OCS are expected to remain covered as by sediment and associated cable protection (where applicable). In non-routine situations, these segments may be uncovered, and reburial might be required (for buried portions of the SRWEC). The seafloor overlaying the majority of buried SRWEC–OCS (where cable protection will not exist) is expected to return to pre-construction conditions over time and no long-term changes to sediment mobility or depositional patterns are expected.

Indirect impacts on finfish and EFH associated with O&M activities for the SRWEC–OCS are expected to result in similar impacts as those discussed for the IAC but will be limited in spatial extent. The protection of the cable with concrete mattresses or rock may result in the long-term conversion of soft bottom habitat to hard bottom habitat. Similar to the foundations, this cable protection may have a long-term impact on finfish and EFH species associated with soft bottom habitats and a long-term beneficial impact on finfish and EFH species associated with hard bottom habitats, depending on the quality of the habitat created by the secondary cable protection, and the quality of the benthic community that colonizes that habitat.

Sediment Suspension and Deposition

Increases in sediment suspension and deposition during the O&M phase may result from vessel anchoring and non-routine maintenance activities that require exposing portions of the SRWEC–OCS. Impacts on finfish and EFH resulting from sediment suspension and deposition during the O&M phase are expected to be similar to those discussed for the construction phase, but on a more limited spatial scale.

Noise

Impacts on finfish and EFH from geophysical surveys and ship and aircraft noise during O&M of the SRWEC–OCS are expected to be similar to those discussed for the construction, though lesser in extent.

CONSTRUCTION AND OPERATIONS PLAN

Site Characterization and Assessment of Impacts – Biological Resources

Electric and Magnetic Fields

Once the SRWEC–OCS becomes energized, the cables will produce a magnetic field that will decrease in strength rapidly with distance. The cable will be shielded and, where feasible, buried beneath the seafloor and will otherwise be protected. DC submarine transmission cables do not directly emit electrical fields into surrounding areas but are surrounded by DC magnetic fields that can cause induced electrical fields in moving water (Gill et al. 2012). Exposure to EMF could be short- or long-term, depending on the mobility of the species.

A modeling analysis of the magnetic fields and induced electric fields anticipated to be produced during operation of the SRWEC–OCS was performed and results are included in Appendix J1. Appendix J1 also summarizes published data from field and laboratory studies conducted to assess impacts of EMF on marine organisms.

Both tagging studies and field surveys have been conducted to determine if the presence of DC submarine cables significantly alter fish migration or the distribution of fish populations at submarine cable sites. Klimley et al. (2017) analyzed the migratory movements of tagged green sturgeon and Chinook salmon in relation to the magnetic field anomalies from a DC submarine cable in San Francisco Bay, and from overhead bridges. Kavet et al. (2016) found that the magnetic anomaly from the DC cables was at least an order of magnitude (ten times) less than that from the bridges. Neither the bridges nor the cables deterred migration movements of green sturgeon or Chinook salmon (Klimley et al. 2017). An acoustic telemetry study monitoring the movements of migratory silver European eel examined the effect of a DC cable on eel movements and concluded that the cable did not act as a barrier or obstruction to migration (Westerberg and Begout-Anras 1999).

A series of biological field surveys along the Monterey Accelerated Research System (MARS) cable off the coast of California tracked the presence of different marine species both before and after the installation and energization of a submarine communication/DC power cable energized to 10 kV. Over 30,000 individuals from 154 taxonomic groups were observed between 2004 and 2015 (Kuhnz et al. 2015). Based on this data, authors concluded that the MARS cable has had little detectable impact on biological assemblages. Similarly, diver studies conducted at sites along the DC Basslink submarine cable indicated no adverse effects on fish communities, but where burial was impractical and the cable was protected with an iron shell, various fish species were observed to be associated with this vertical structure (Sherwood et al. 2016).

Hutchison et al. (2018, 2020) assessed the responses of American lobster to a DC cable under field conditions and concluded that EMF resulted in small-scale changes in lobster distribution within the cages, although the cable was not observed to present a barrier to movement.

At peak loading, the magnetic fields produced by the DC cables at the overlying seabed are projected to be well below the levels detectable by finfish, including Atlantic sturgeon (Appendix J1). Similarly, electric fields associated with DC cables at peak loading are expected to be detectable by elasmobranchs, but based on available field studies, slightly below levels documented to elicit minor changes in the behaviors of elasmobranchs. Therefore, the SRWEC–OCS will not result in adverse effects on finfish species or EFH.

CONSTRUCTION AND OPERATIONS PLAN

Site Characterization and Assessment of Impacts – Biological Resources

Discharges and Releases

Impacts from marine discharges and releases during O&M are expected to be similar to, but of lesser likelihood than during construction, as there will be fewer Project-related marine vessels during this phase, and regulatory requirements and preventative measures will still apply.

Trash and Debris

Impacts from disposal of trash and debris during O&M are expected to be similar to, but of lesser likelihood than during construction, as there will be fewer Project-related marine vessels during this phase, and regulatory requirements and preventative measures will still apply.

Traffic

Impacts associated with vessel traffic during SRWEC–OCS O&M are identified under the Seafloor Disturbance, Noise, Sediment Suspension and Deposition, and Lighting sections. Potential impacts on Atlantic sturgeon are also expected to be similar to construction. Additional discussion of potential impacts on Atlantic sturgeon is provided in Appendix O.

Lighting and Marking

Impacts on finfish and EFH from artificial lighting during SRWEC–OCS O&M are expected to be similar to the impacts from artificial lighting for O&M of the SRWF, though lesser in extent, as there are no permanent lighted structures associated with the SRWEC–OCS.

Sunrise Wind Export Cable – NYS

Construction

Seafloor and Land Disturbance

Direct impacts on benthic species and life stages from seafloor preparation, SRWEC–NYS installation, and vessel anchoring are expected to be minor and similar to those discussed for construction of the SRWEC–OCS. Seafloor preparation, SRWEC–NYS installation, and vessel anchoring are expected to have insignificant impacts on finfish and EFH species that have pelagic early or later life stages.

Construction of the SRWEC–NYS Landfall would be accomplished using HDD methodology. Within the SRWEC–NYS corridor, HDD exit pits (one per HDD) would be dredged. A barge or jack-up vessel may be used at this location to assist the drilling process, handle the pipe for pull in, and for other support activities. To minimize the potential risks associated with an inadvertent drilling fluid return/release, Sunrise Wind will develop an Inadvertent Return Plan for the inadvertent release of drilling fluids prior to construction and will implement appropriate best management practices. Potential impacts from the HDD exit pit would be similar to those discussed for seafloor preparation, but on a smaller scale.

CONSTRUCTION AND OPERATIONS PLAN

Site Characterization and Assessment of Impacts – Biological Resources

As described in the construction discussion for the SRWF, fish eggs and larvae (ichthyoplankton), as well as zooplankton, are expected to be entrained and killed during jet plow embedment of the SRWEC–NYS and CFE associated with sand wave leveling. These losses are expected to be very low, based on a previous assessment conducted for the South Fork Wind Farm, which found that the total estimated losses of zooplankton and ichthyoplankton from jet plow entrainment were less than 0.001 percent of the total zooplankton and ichthyoplankton abundance present in the Study Area, which encompassed a linearly buffered region of 15 km around the South Fork Export Cable and 25 km around the South Fork Wind Farm (INSPIRE Environmental 2018b).

As discussed for the construction of the SRWEC–OCS, in areas of sediment disturbance, benthic habitat recovery and benthic infaunal and epifaunal species abundances may take up to 1 to 3 years to recover to pre-impact levels, based on the results of a number of studies on benthic recovery (e.g., AKRF, Inc. et al. 2012; Germano et al. 1994; Hirsch et al. 1978; Kenny and Rees 1994). Recolonization of sediments by epifaunal and infaunal species and the return of mobile fish and invertebrate species will allow this area to continue to serve as foraging habitat for finfish and EFH species. Pelagic species/life stages may be indirectly affected by the temporary reduction of benthic forage species, but these impacts are expected to be insignificant given the availability of similar habitats in the area. Other species may be attracted to the disruption and prey on dislodged benthic species or other species injured or flushed during seafloor preparation, SRWEC–NYS installation, and vessel anchoring activities.

Sediment Suspension and Deposition

As discussed for the SRWEC–OCS, seafloor-disturbing activities associated with the SRWEC–NYS will also result in temporary increases in sediment suspension and deposition. Within the SRWEC–NYS corridor, HDD exit pits (one per HDD) would be dredged. Sediment transport modeling for the Project was performed by using the PTM to evaluate the concentrations of suspended sediments, spatial extent and duration of sediment plumes, and the seafloor deposition resulting from construction activities. The sediment transport modeling results are summarized in Table 4.4.2-2. The model, inputs, and results are described in detail in Appendix H.

During installation of the SRWEC–NYS, modeling results indicate that sediment plumes with TSS concentrations exceeding the ambient conditions by 100 mg/L does not occur. The model estimated that the elevated TSS concentrations would be of short duration and expected to return to ambient conditions within 0.34 hours following the cessation of cable burial activities. Sedimentation from SRWEC–NYS burial is predicted to exceed 0.4 in (10 mm) of deposition up to 253 ft (77 m) from the cable corridor centerline. This thickness of sedimentation is expected to cover approximately 53.1 acres (215,000 m²) in state waters, and the TSS plume was predicted to be primarily contained within the lower portion of the water column, approximately 8.5 ft (2.5 m) above the seafloor. Mechanical dredging of HDD exit pits is not expected to elevate TSS concentrations more than 100 mg/L above ambient conditions, and TSS concentrations are expected to return to ambient within 0.3 hours. Sedimentation from HDD exit pit dredging may exceed 0.4 in (10 mm) of deposition up to 79 ft (24 m) from the pit and cover approximately 0.25 acres (1,012 m²). The TSS plume was predicted to be primarily contained within the lower portion of the water column, approximately 7.2-ft (2.2-m) above the seafloor.

CONSTRUCTION AND OPERATIONS PLAN

Site Characterization and Assessment of Impacts – Biological Resources

Similar to the impacts discussed for the construction of the SRWEC–OCS, direct impacts on finfish and EFH from sediment suspension and deposition associated with construction of the SRWEC–NYS are expected to be similar to those discussed for construction of the SRWF, with greater impacts on sessile and slow-moving benthic species/life stages compared to mobile and pelagic species/life stages. In shallow waters, TSS plumes from construction activities may occupy the majority of the water column, and mobile species/life stages may temporarily vacate the area of disturbance.

Noise

Construction of the SRWEC–NYS Landfall would be accomplished using HDD methodology. Within the SRWEC–NYS corridor, HDD exit pits (one per HDD) would be dredged. A barge or jack-up vessel may be used at this location to assist the drilling process, handle the pipe for pull in, and for other support activities. Direct impacts on finfish and EFH resulting from vessel, construction equipment, and aircraft noise are expected to be similar to those discussed for construction of the SRWEC–OCS.

Discharges and Releases

The potential for exposure and adverse impacts from routine and non-routine discharges and releases will be similar to those identified for the SRWF. Additionally, HDD at Landfall will use a drilling fluid that consists of bentonite, drilling additives, and water. A barge or jack-up vessel may also be used to assist the drilling process; handle the pipe for pull in; and help transport the drilling fluids and mud for treatment, disposal, and/or reuse. To minimize the potential risks for an inadvertent drilling fluid release, an Inadvertent Return Plan will be developed and implemented during construction. Refer to Section 3.3.3.3 for additional details regarding HDD installation and the use of drilling fluids.

Trash and Debris

The potential for exposure and adverse impacts from routine and non-routine activities resulting in trash and debris will be similar to those identified for the SRWF. Depending on the type of trash or debris, fish could become entangled or ingest foreign materials, causing injury or mortality. However, with proper waste management procedures, the potential for trash or debris to be inadvertently left overboard or introduced into the marine environment is not anticipated.

Traffic

Impacts associated with vessel traffic during SRWEC–NYS construction are identified under the Seafloor Disturbance, Noise, Sediment Suspension and Deposition, and Lighting sections. Potential impacts on Atlantic sturgeon are also expected to be similar to construction of the SRWEC–OCS. Additional discussion of potential impacts on Atlantic sturgeon is provided in Appendix O.

Lighting and Marking

During construction and decommissioning activities, navigational and deck lighting will be utilized from dusk to dawn on the vessels that will be installing or decommissioning the SRWEC–NYS. Direct impacts on finfish and EFH from artificial lighting are expected to be short-term because the vessels are expected to pass quickly along the SRWEC route during cable installation.

CONSTRUCTION AND OPERATIONS PLAN

Site Characterization and Assessment of Impacts – Biological Resources

As discussed for the SRWEC–OCS, artificial lighting associated with SRWEC–NYS installation would be temporary and limited relative to the surrounding areas and impacts on finfish and EFH are expected to be insignificant.

Operations and Maintenance

Seafloor and Land Disturbance

Minimal impacts on finfish and EFH are expected from operation of the SRWEC–NYS, as it will be buried beneath the seabed where feasible and will otherwise be protected. As discussed for the SRWEC–OCS, seafloor disturbance during O&M of the SRWEC–NYS will be limited to non-routine maintenance that may require uncovering and reburial of the cables, as well as maintenance of cable protection where present. These maintenance activities and associated vessel anchoring are expected to result in similar impacts on finfish and EFH as those discussed for the SRWEC–OCS.

As discussed for the SRWEC–OCS, cable protection (e.g., concrete mattresses or rock placement) may be placed in select areas along the SRWEC–NYS. The seafloor overlaying the majority of buried SRWEC–NYS (where cable protection will not exist) is expected to return to pre-construction conditions over time and no long-term changes to sediment mobility and depositional patterns are expected.

Impacts on finfish and EFH associated with O&M activities for the SRWEC–NYS are expected to result in similar impacts as those discussed for the IAC and SRWEC–OCS, but will be limited in spatial extent. The protection of the cable with concrete mattresses or rock may result in the long-term conversion of soft bottom habitat to hard bottom habitat. Similar to the foundations, this cable protection may have a long-term impact on finfish and EFH species associated with soft bottom habitats and a long-term beneficial impact on finfish and EFH species associated with hard bottom habitats, depending on the quality of the habitat created by the secondary cable protection, and the quality of the benthic community that colonizes that habitat.

Sediment Suspension and Deposition

Increases in sediment suspension and deposition during the O&M phase may result from vessel anchoring and non-routine maintenance activities that require exposing portions of the SRWEC–NYS. Direct impacts on finfish and EFH resulting from sediment suspension and deposition during the O&M phase are expected to be similar to those discussed for the construction phase, but on a more limited spatial scale.

Noise

Impacts on finfish and EFH from geophysical surveys and ship and aircraft noise during O&M of the SRWEC–NYS are expected to be insignificant and similar to those discussed for the construction phase, though lesser in extent.

Electric and Magnetic Fields

As discussed for the SRWEC–OCS, a modeling analysis of the magnetic fields and induced electric fields anticipated to be produced during operation of the SRWEC–NYS was performed and results are included in Appendix J1. It is not expected that finfish and EFH will be measurably affected by EMF from the SRWEC–NYS.

CONSTRUCTION AND OPERATIONS PLAN

Site Characterization and Assessment of Impacts – Biological Resources

Discharges and Releases

Impacts from marine discharges and releases during O&M are expected to be similar to, but of lesser likelihood than during construction, as there will be fewer Project-related marine vessels during this phase, and regulatory requirements and preventative measures will still apply.

Trash and Debris

Impacts from disposal of trash and debris during O&M are expected to be similar to, but of lesser likelihood than during construction, as there will be fewer Project-related marine vessels during this phase, and regulatory requirements and preventative measures will still apply.

Traffic

Impacts associated with vessel traffic during SRWEC–NYS O&M are identified under the Seafloor Disturbance, Noise, Sediment Suspension and Deposition, and Lighting sections. As discussed for the SRWEC–OCS, vessel traffic during O&M is not expected to negatively affect Atlantic sturgeon. Additional discussion of potential impacts on Atlantic sturgeon is provided in Appendix O.

Lighting and Marking

Artificial lighting during O&M of the SRWEC–NYS will be associated only with vessels. Lighting will be limited to the minimum necessary to ensure safety and to comply with applicable regulations. Because of the limited area that will have artificial lighting relative to the surrounding areas, and because no underwater lighting is proposed, impacts on finfish and EFH are expected to be insignificant.

Onshore Facilities

Construction

Seafloor and Land Disturbance

Onshore Facilities are expected to have minimal impacts on finfish and EFH due to the majority of the facilities being on land, as well as the use of HDD where the Onshore Transmission Cable crosses the ICW between Bellport Bay and Narrow Bay, just west of the Smith Point Bridge. The proposed Onshore Transmission Cable route may cross under SAV habitats and macroalgal mats that are considered HAPC for summer flounder in the ICW. The use of HDD will avoid impacts to SAV habitats and macroalgal mats; however, impacts could occur in the unlikely event of an inadvertent release of drilling fluid (see discussion on Sediment Suspension and Deposition and Discharges and Releases). Impacts on finfish species at the Carmans River crossing are also expected to be minimal as the Onshore Transmission Cable will cross the river via HDD.

The temporary floating pier that may be installed to aid in the transport of equipment and materials for the Landfall HDD and ICW HDD (Section 3.3.10.2) may temporarily impact EFH in its direct vicinity. The temporary floating pier would be up to approximately 1,500 sq ft and would consist of a floating module and a ramp connecting the floating module to shore.

The temporary floating pier will be secured to the seabed with spuds. Some minimal seafloor disturbance would occur along the northern shoreline of Smith Point County Park, from the spuds for the temporary floating pier as well as the spuds from the barge, which could cause minimal, temporary impacts to finfish and EFH in the immediate vicinity of the pier.

CONSTRUCTION AND OPERATIONS PLAN

Site Characterization and Assessment of Impacts – Biological Resources

Additionally, depending on the tides and water depths at the selected location, a portion of the temporary floating pier may be grounded at times, particularly closer to the shoreline, which may result in temporary tidal wetland impacts. The tidal range in the ICW is approximately 2 ft. The temporary floating pier would likely be set up for a few weeks in the fall and a few weeks in the spring to bring over and remove equipment. Depending on the logistics planning, the temporary floating pier may need to remain in place from fall to spring. Given the shallow depths and relatively low hydrodynamics, the benthic environment in this area may be suitable for SAV. The temporary floating pier may crush SAV if it exists directly below the structure when it becomes grounded. The temporary floating pier may also shade the benthos in its vicinity, reducing the photosynthetically active radiation available for SAV. However, the pier will be micro-sited to avoid SAV to the extent practicable and the time of year when the proposed temporary floating pier is planned will likely occur after the seasonal SAV senesce (late fall) and prior to when the SAV begin germinating (early spring), and thus will minimize impacts. Submerged aquatic vegetation surveys will be conducted prior to construction and the pier will be positioned to avoid and minimize impacts to this sensitive habitat.

Sediment Suspension and Deposition

Construction of the Onshore Transmission Cable will be accomplished using HDD methodology where the proposed route crosses the ICW and the Carmans River. The proposed Onshore Transmission Cable route may cross under tidal wetlands, SAV habitat, and macroalgal mats in the ICW that are considered HAPC for summer flounder. The use of HDD would avoid impacts to this sensitive habitat; however, impacts could occur in the unlikely event of an inadvertent release of drilling fluid. An inadvertent release occurs when drilling fluids (i.e., naturally occurring bentonite clay) migrate unpredictably to the surface of the seafloor through fractures, fissures, or other conduits in the underlying rock/sediments. An inadvertent release of drilling fluid along the HDD segment could cause a temporary turbidity plume; however, bentonite clay particles would be expected to settle quickly due to the natural flocculation of clay particles in seawater. Although bentonite by itself is non-toxic, it is a fine particulate material that could become entrained in the water column and transported to other locations if sufficient current velocities were present, causing turbidity and sedimentation.

Mobile species could be temporarily displaced by a turbidity plume and, depending on the thickness of materials settling on the seafloor, demersal eggs/larvae could be at risk of smothering or other injury. Demersal/benthic finfish eggs and larvae in the vicinity of a release may potentially experience short-term, direct impacts from a temporary increase in sedimentation/deposition. Eggs and larvae can be more sensitive to sediment deposition (Berry et al. 2003). They are unable to relocate from the affected areas and, therefore, would be more susceptible to impacts from an inadvertent release compared to juveniles and adults. Impacts on finfish and EFH species, if they were to occur, would be temporary and localized, and would generally be limited to individuals in the immediate vicinity of the release.

CONSTRUCTION AND OPERATIONS PLAN

Site Characterization and Assessment of Impacts – Biological Resources

Noise

Construction of the Onshore Transmission Cable at the ICW and the Carmans River crossing will be accomplished using HDD methodology. No impacts on the underwater noise environment of Carmans River are expected due to these activities as they will occur from an onshore work area. A barge may be used at the ICW location for support activities. Direct impacts on finfish and EFH resulting from barge traffic and construction noise at the ICW are expected to be similar to those discussed for construction of the SRWEC–OCS.

Discharges and Releases

Although no impacts from discharges and releases are anticipated, spills or accidental releases of fuels, lubricants, or hydraulic fluids could occur during use of trenchless installation and duct bank installation methods, installation of the Onshore Transmission Cable or Onshore Interconnection Cable, or during construction activities at the OnCS–DC. An SPCC Plan will be developed and any discharges or release will be governed by NYS regulations. Any unanticipated discharges or releases within the Onshore Facilities during construction are expected to result in minimal, temporary impacts; activities are heavily regulated, and discharges and releases are considered accidental events that are unlikely to occur. Additionally, where HDD is utilized, an Inadvertent Return Plan will be prepared and implemented to minimize the potential risks associated with release of drilling fluids. The potential for a significant loss of drilling fluid in this inshore environment is considered to be low. Given this information, impacts on summer flounder HAPC, finfish, and EFH as a result of an inadvertent release of drilling fluid are not expected.

Trash and Debris

Good housekeeping practices will be implemented to minimize trash and debris in onshore work areas. These practices will include orderly storage of tools, equipment, and materials, as well as proper waste collection, storage, and disposal to keep work areas clean and minimize potential environmental impacts. All trash and debris returned to shore from offshore vessels will be properly disposed of or recycled at licensed waste management and/or recycling facilities.

Disposal of any solid waste or debris in the water will be prohibited. With proper waste management procedures, the potential for trash or debris to be inadvertently introduced onto an onshore area is unlikely.

Traffic

Traffic due to the construction of Onshore Facilities is not expected to impact finfish and EFH due to the minimal portion of Onshore Facilities that cross waterbodies inhabited by finfish.

Operations and Maintenance

Seafloor and Land Disturbance

Minimal impacts on finfish and EFH are expected from operation of the Onshore Transmission Cable, as it will be buried beneath the seabed of the ICW, between Bellport Bay and Narrow Bay, and buried via HDD at the Carmans River crossing. Any non-routine maintenance would occur through the HDD cable duct and would not impact the environment of the ICW or Carmans River.

CONSTRUCTION AND OPERATIONS PLAN

Site Characterization and Assessment of Impacts – Biological Resources

Electric and Magnetic Fields

As discussed for the SRWEC–OCS, a modeling analysis of the magnetic fields and induced electric fields anticipated to be produced during operation of the Onshore Transmission Cable was performed and results are included in Appendix J1. It is not expected that finfish and EFH will be measurably affected by EMF from the Onshore Transmission Cable.

Discharges and Releases

The OnCS–DC will require various oils, fuels, and lubricants to support its operation, and SF₆ gas will also be used for electrical insulating purposes. As described above in the construction section, accidental discharges, releases, and disposal could indirectly cause habitat degradation, but risks will be avoided through implementation of the measures described in the SPCC Plan.

Trash and Debris

Solid waste and other debris will be generated predominantly during Project construction activities but may also occur during O&M of the Onshore Facilities. With the implementation of proper waste management procedures, and adherence to regulations, the potential for trash or debris to be inadvertently introduced onto an onshore area is unlikely.

4.4.3.3 Proposed Environmental Protection Measures

Sunrise Wind will implement the following environmental protection measures to reduce potential impacts on finfish and EFH:

- Sunrise Wind is committed to collaborative science with the commercial and recreational fishing industries prior to, during, and following construction. Fisheries monitoring studies are being planned to assess the impacts associated with the Project on economically and ecologically important fisheries resources within the SRWF, along the SRWEC, and in the ICW. These studies will be conducted in collaboration with the local fishing industry and will build upon monitoring efforts being conducted by affiliates of Sunrise Wind at other wind farms in the region.
- To the extent feasible, installation of the IAC and SRWEC will be buried using equipment such as mechanical plow, jet plow, and/or mechanical cutter. These equipment options would result in less habitat modification than dredging options. The feasibility of cable burial equipment will be determined based on an assessment of seabed conditions and the Cable Burial Risk Assessment.
- To the extent feasible, the SRWEC and IAC will typically target a burial depth of 3 to 7 ft (1 to 2 m). The target burial depth will be determined based on an assessment of seabed conditions, seabed mobility, the risk of interaction with external hazards such as fishing gear and vessel anchors, and a site-specific Cable Burial Risk Assessment. The SRWEC Landfall will be installed via HDD to avoid impacts to the nearshore zones and finfish resources. The Onshore Transmission Cable will also be installed via HDD under the ICW to avoid impacts to coastal resources; HDD and trenchless methods will also be used elsewhere onshore, where appropriate, to minimize impacts to resource areas.

CONSTRUCTION AND OPERATIONS PLAN

Site Characterization and Assessment of Impacts – Biological Resources

- Construction and operational lighting will be limited to the minimum necessary to ensure safety and compliance with applicable regulations. Limiting lighting to that which is required for safety and compliance with applicable regulations is expected to minimize impacts on EFH.
- DP vessels will be used for installation of the IAC and SRWEC to the extent practicable. Use of DP vessels will minimize impacts to the seabed, compared to use of a vessel relying on multiple anchors. A plan for vessels will be developed prior to construction to identify no-anchorage areas to avoid documented sensitive resources.
- Time-of-year in-water restrictions will be employed to the extent feasible to avoid or minimize direct impacts to species of concern, such as Atlantic sturgeon or winter flounder, during construction. If work is anticipated to occur outside of these time-of-year restriction periods, Sunrise Wind will work with state and federal agencies to develop construction monitoring and impact minimization plans or mitigation plans, as appropriate.
- Accidental spill or release of oils or other hazardous materials will be managed offshore through an ERP/OSRP and onshore through an SPCC Plan.
- Sunrise Wind will require all construction and O&M vessels to comply with applicable international (IMO MARPOL), federal (USCG and EPA), and NYS regulations and standards for the management, treatment, discharge, and disposal of onboard solid and liquid wastes and the prevention and control of spills and discharges.

4.4.4 Marine Mammals

This section describes the affected environment and potential effects from the construction and operation of the Project as they relate to marine mammals. The discussion of the affected environment for marine mammals is followed by an evaluation of potential Project-related impacts and a summary of environment protection measures that Sunrise Wind will implement to avoid, minimize, and mitigate potential impacts to these resources.

Marine mammals inhabit all the world's oceans and can be found in coastal, estuarine, shelf, and pelagic habitats. Within the Project Area, this broad taxonomic category includes cetaceans and pinnipeds. Cetaceans consist of two separate groups: odontocetes (toothed whales, dolphins, and porpoises) and mysticetes (baleen whales). The odontocetes all possess teeth and generally feed on fish and invertebrates. The mysticetes possess large baleen filtration systems instead of teeth which they use to sieve smaller prey, usually zooplankton and small schooling fish, out of the water. Both groups transit over large distances; many mysticetes migrate seasonally between distinct feeding and breeding areas while odontocetes generally follow local prey distributions and exhibit less distinct migratory behavior. The toothed whales, dolphins, and porpoises are generally found in large, often stable, pods throughout their lives. Baleen whales in contrast are known to maintain small, unstable groups or remain as solitary individuals when not breeding (Wilson and Ruff 1999). Whales are capable of very deep or prolonged dives while the smaller dolphin and porpoise species generally dive to shallower depths for shorter periods. Pinnipeds are a diverse clade, which in the Project Area include only one family: the phocids (earless seals). Phocids are the most diverse and widespread family of pinnipeds. Quite different from the cetaceans, phocids are fur-bearing, carnivorous mammals that are semi-aquatic and make use of both marine and terrestrial habitats throughout their lives.

CONSTRUCTION AND OPERATIONS PLAN

Site Characterization and Assessment of Impacts – Biological Resources

The following description of the affected environment and assessment of potential impacts to marine mammals were developed by reviewing current public data sources related to marine mammals. These include: the NOAA NEFSC's Atlantic Marine Assessment Program for Protected Species (AMAPPS) (NOAA Fisheries 2020a; Palka et al. 2017); the Northeast Large Pelagic Survey Collaborative Aerial and Acoustic Surveys for Large Whales and Sea Turtles (Kraus et al. 2016); Remote Marine and Onshore Technology surveys for NYSERDA (Normandeau and APEM 2019); a technical report for the Rhode Island OSAMP (Kenney and Vigness-Raposa 2010); a technical report for the New York State Offshore Wind Master Plan (NYSERDA 2017); stranding and entanglement information from the Atlantic Marine Conservation Society (AMCS), Center for Coastal Studies (CFCS) and Coastal Research and Education Society of Long Island (CRESLI); online data portals and mapping databases (e.g., marine mammal habitat density data available on the Northeast Ocean Portal [Curtice et al. 2019; Roberts et al. 2016a, b, 2017, 2018]); NOAA stock assessment reports (Hayes et al. 2017, 2018, 2019, 2020) and recovery plans (e.g., NOAA Fisheries 2013); the New York Bight Whale Monitoring Final Comprehensive Report per the Whale Monitoring Program (Tetra Tech and LGL 2020; NYSDEC 2021); published scientific literature relating to relevant marine mammals; correspondence and consultation with federal and state agencies; and information provided in environmental assessments conducted by BOEM offshore Massachusetts and Rhode Island (BOEM 2013, 2014, 2019, 2020a).

Where available, the assessment also draws from Protected Species Observer (PSO) sightings data derived from G&G surveys undertaken across the marine portions of the Project Area (Smultea Sciences 2020) and the Bay State Wind project area (Smultea Sciences 2019). The following analysis includes a summary of these survey results, with additional details found in Appendix O. Sunrise Wind recognizes that PSO sightings data are opportunistic (not systematically collected); however, it is included herein to provide supplemental sightings data for marine mammal species and to provide additional findings related to inter-annual variation in species occurrence in the marine portions of the Project Area. Sightings data if used with discretion can be valuable (BOEM 2018) from a practical standpoint in that they inform which species may be expected to be present during operations. Previous BOEM reports have utilized PSO data for such purposes (Barkaszi and Kelly 2019).

Specific requirements for submittal of marine mammal information within this COP are provided in BOEM's *Guidelines for Providing Information on Marine Mammals and Sea Turtles for Renewable Energy Development on the Atlantic Outer Continental Shelf pursuant to 30 CFR Part 585 Subpart F* (BOEM 2019). These guidelines include specific assessment requirements such as determining spatial temporal distribution and abundance of marine mammal species and establishing baseline ambient sound levels and presence of vocalizing marine mammals. The following assessment considers these guidelines.

CONSTRUCTION AND OPERATIONS PLAN

Site Characterization and Assessment of Impacts – Biological Resources

All marine mammal species in US waters are protected under the *Marine Mammal Protection Act* of 1972, as amended (MMPA) (16 U.S.C. §§ 1361 et seq.), and some are listed under the *Endangered Species Act* of 1973, as amended (ESA). BOEM must also consult with NOAA Fisheries or USFWS under Section 7 of the ESA for actions that could affect protected marine species under NOAA Fisheries or USFWS jurisdictions (e.g., various marine mammals or sea turtles). Consultation is required for approval of a COP because the activities described in a COP may affect listed marine wildlife species. This assessment is also informed by extensive and ongoing engagement with NOAA Fisheries and stakeholders. A summary of agency correspondence is provided in Appendix A.

A description of the marine mammals in the SRWF, along the SRWEC, in the ICW, and along coastal and ICW shorelines is provided below, followed by an evaluation of potential Project-related impacts. For the purposes of the marine mammal analysis, discussion of Great South Bay was also included. Sightings and potentially suitable habitat data from Great South Bay are considered representative data for the ICW which is hydrologically connected and immediately adjacent. More detailed information concerning species-specific marine mammal life history, presence, and distribution within the Project Area along with potential Project-related impacts with an emphasis on acoustic impacts is presented in Appendix O. Sunrise Wind also completed a comprehensive underwater noise modeling effort (Appendix I1), which is summarized in Appendix O.

4.4.4.1 Affected Environment

Regional Overview

Thirty-six species of marine mammals inhabit the regional waters of the western North Atlantic OCS; these include six mysticetes (baleen whales), 25 odontocetes (toothed whales, dolphins, and porpoise), four pinnipeds (earless or true seals), and one species of sirenian (manatee). Species sightings data from 1960 to 2019 provided by OBIS-SEAMAP from illustrate the presence of these species within the region by group (Figure 4.4.4-1, Figure 4.4.4-2, and Figure 4.4.4-3). Table 4.4.4-1 outlines each of the species included in these groups along with associated conservation status, relative occurrence within the Project Area, estimated population sizes, and identification as 'strategic stock.' As defined by the MMPA, a strategic stock is "a mammal stock: (a) for which the level of direct human-caused mortality exceeds the potential biological removal level; (2) which, based on the best available scientific information, is declining and is likely to be listed as a threatened species under the [ESA] within the foreseeable future; or (c) which is listed as a threatened or endangered species under the [ESA] or is designated as depleted under [the MMPA]" (16 U.S.C. § 1362[19]).

The relative occurrence noted in Table 4.4.4-1 is based on five qualitative categories, which are defined as follows:

- **Common.** Species occurs consistently in moderate to large numbers.
- **Regular.** Species occurs in low to moderate numbers on a regular basis or seasonally.
- **Uncommon.** Species occurs in low numbers or on an irregular basis.
- **Rare.** Species records are available for some years but are limited.

CONSTRUCTION AND OPERATIONS PLAN

Site Characterization and Assessment of Impacts – Biological Resources

- **Not expected.** Species' range includes the Project Area, but due to habitat preferences and distribution information, species is not expected to occur in the Project Area although records may exist for adjacent waters.

Of the 36 marine mammal species/stocks with geographic ranges that include the western North Atlantic OCS, 22 are not expected to be present or are considered to occur only rarely within the Project Area, while the remaining 14 species commonly or regularly occur in the Project Area. These latter species can be reasonably expected to reside, traverse, or routinely visit the Project Area based on information from surveys conducted in the region, NOAA stock assessment reports, and other published literature. Life history characteristics and sightings data of these common or regularly occurring species are detailed in Appendix O.

Five of the marine mammal species known to have a presence in the Project Area year-round or seasonally in offshore New York, Massachusetts, and Rhode Island waters are ESA-listed: the humpback whale, fin whale, sei whale, sperm whale, and North Atlantic right whale. The humpback whale, which may occur year-round, was recently delisted as an endangered species. Seven species, stocks, or distinct population segments (DPS) are also protected under the US ESA or Canada's *Species at Risk Act*, six species are listed by the state of New York, three species are listed by the state of Rhode Island, and six species are listed by the Commonwealth of Massachusetts. The marine mammals known to occur in the Project Area are all from single stocks except for the bottlenose dolphin.

In recent years, rare incidental sightings of typically northern species such as the St. Lawrence beluga whale (*Delphinapterus leucas*) and the bowhead whale (*Balaena mysticetus*), have been reported off Massachusetts and the Gulf of Maine (Nalpathanchil and Brandon 2014; NOAA Fisheries 2019a). Similarly, in recent years, arctic species including ringed seals (*Pusa hispida*), that were once extremely rare for the Project Area, have been documented in rare incidental sightings (AMCS 2020; CRESLI 2020). However, these species' typical geographic ranges and NOAA stock definitions do not overlap with the Project Area, and the species are highly unlikely to be encountered. Per Orsted's most recently-submitted Incidental Harassment Authorization application (CSA Ocean Sciences Inc 2020), NOAA Fisheries concurred that these species do not warrant further consideration.

To support the protection of marine mammals and other marine species, designated marine protected areas and North Atlantic right whale seasonal management areas (SMA) have been identified by NOAA Fisheries throughout the US. One marine protected area overlaps with the SRWEC–NYS and Onshore Facilities: the Fire Island National Seashore. Additionally, one Mid-Atlantic North Atlantic right whale SMA will be crossed by the SRWF and SRWEC–OCS: the Block Island Sound SMA (NOAA Fisheries n.d.[a]). This SMA is further discussed below as it pertains to the North Atlantic right whale. No designated critical habitats for marine mammals will be crossed by the Project.

Historically, seal species included primarily harbor and gray seals, which are still relatively abundant in the Project Area waters from late fall until late spring; however, in recent years, arctic seal species, such as harp, hooded, and ringed seals, that were once extremely rare for the Project Area have also been sighted irregularly (CRESLI 2020). West Indian manatees have also been sighted in the region on extremely rare occurrences, even though the southeastern United States, is the recognized northern limit of their range (Lefebvre et al. 2001).

CONSTRUCTION AND OPERATIONS PLAN

Site Characterization and Assessment of Impacts – Biological Resources

In 2018, a UME for harbor and gray seals was declared across Maine, New Hampshire, and Massachusetts due to an increase in mortalities from infectious disease (NOAA Fisheries 2020b). The UME investigation now encompasses all seal strandings from Maine to Virginia, as seals began showing clinical signs of stranding as far south as Virginia. Investigations of harp and hooded seal strandings have also begun to show clinical signs of infectious disease, therefore the two species were added to the UME investigation, which is ongoing. From July 1, 2018 to March 13, 2020 a total of 172 seals have been stranded within NYS waters (NOAA Fisheries 2020b). Scientists are currently reviewing data collected to provide guidance for the UME investigation; however, it is not expected that the Project will contribute to pinniped infectious disease concerns and further discussion is not included within this analysis.

This page intentionally left blank

V:\1956\active_Task Owner and other Non-BC1956_Jobs\2028113199\03_data\gis_ced\gis\Map\KDs\COP\2028113199_4.4.4-1_MysticSightinging.mxd Revised: 2021-05-07 By: gcarpentier

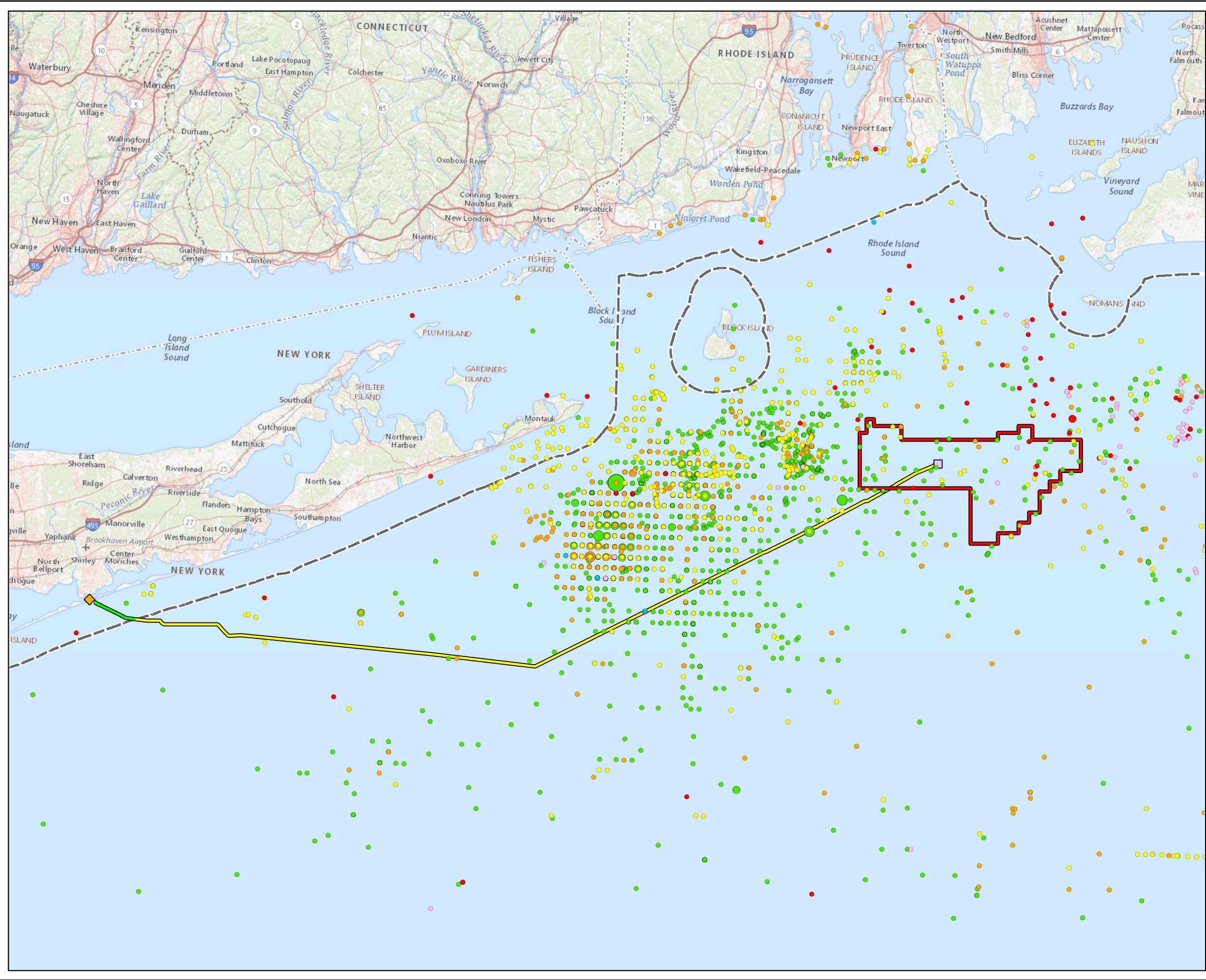

Figure 4.4.4-1
OBIS-SEAMAP Baleen Whale Sightings Data
1960 – 2019

Sunrise Wind | Powered by **Ørsted & Eversource**

Legend

- Sunrise Wind Farm (SRWF)
- Offshore Converter Station (OCS-DC)
- ◆ SRWEC Landfall Location
- Sunrise Wind Export Cable (SRWEC-OCS)
- Sunrise Wind Export Cable (SRWEC-NYS)
- 3-nm State Waters Boundary

Baleen Whale Sighting	Baleen Whale Sighting Count
● Blue whale	 1 - 20
● Fin whale	 21 - 40
● Humpback whale	 41 - 60
● Minke whale	 61 - 80
● North Atlantic right whale	 81 - 100
● Sei whale	

Sources

1. Mysticeti data extracted on 7/22/2020 from the Ocean Biodiversity Information System Spatial Ecological Analysis of Megavertebrate (OBIS-SEAMAP).
2. Base map: USGS The National Map

Date	12/18/2020 Revised: 6/1/2021
Project Number	2028113199
Prepared By	EE
Reviewed By	GC

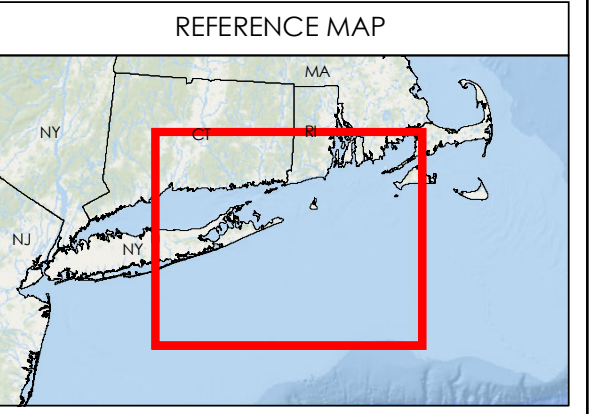
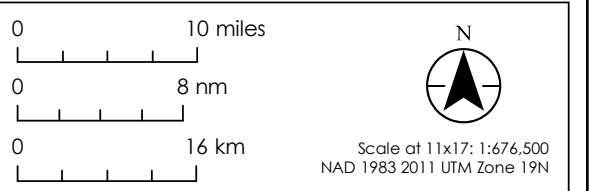

This page intentionally left blank

V:\1956\active_Task Owner and other Non-BC1956.Jobs\2028113199\03_data\gis_ced\gis\mxd\COP2028113199_4.4.4-2_OdontoceitiSighting.mxd Revised: 2021-05-07 By: gcarpentier

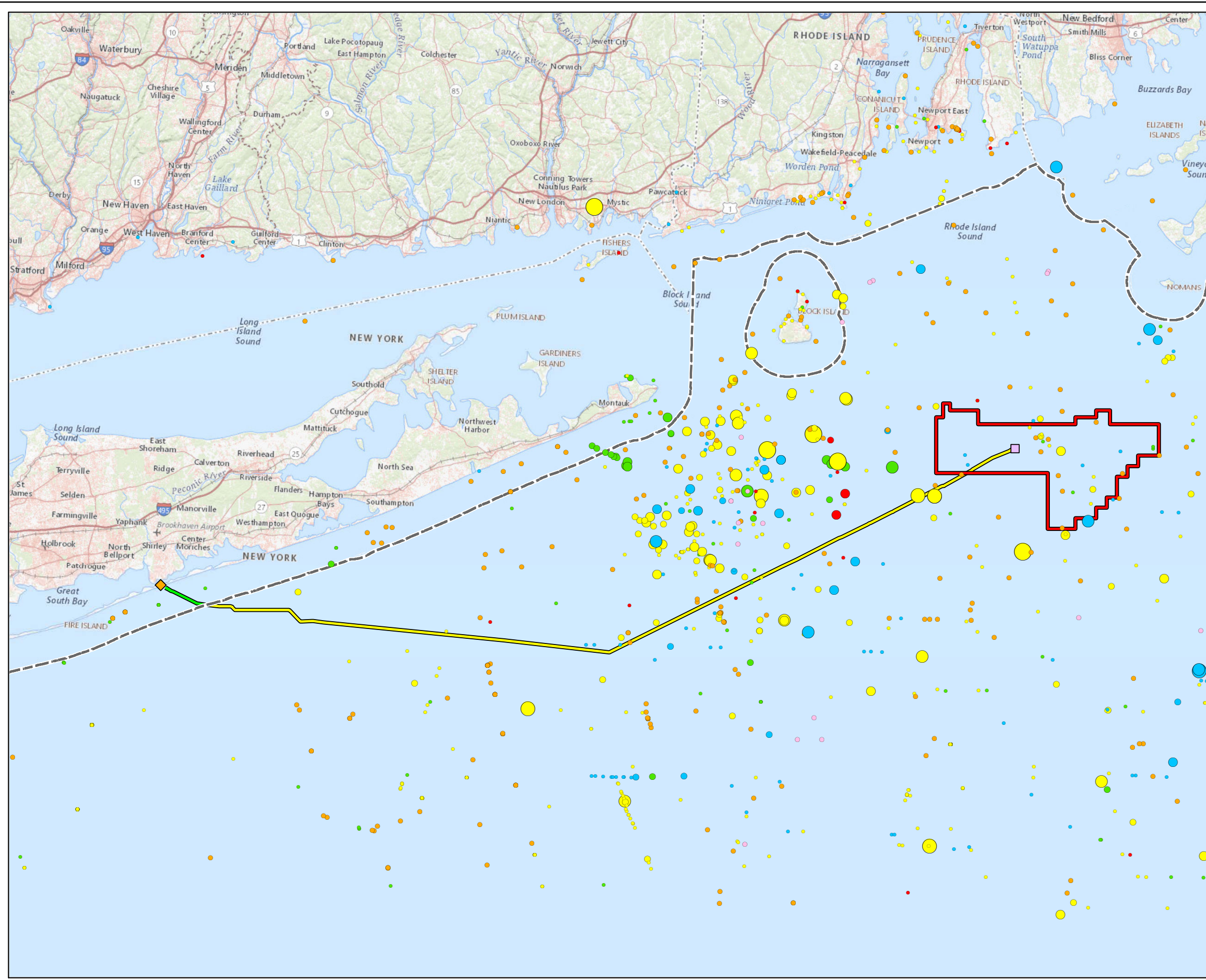

Figure 4.4-4-2
OBIS-SEAMAP Toothed Whale Sightings Data
 1974 – 2019

Sunrise Wind | Powered by **Ørsted & Eversource**

Legend

- Sunrise Wind Farm (SRWF)
- Offshore Converter Station (OCS-DC)
- ◆ SRWEC Landfall Location
- Sunrise Wind Export Cable (SRWEC-OCS)
- Sunrise Wind Export Cable (SRWEC-NYS)
- 3-nm State Waters Boundary

Toothed Whale Sighting	Toothed Whale Sighting Count
● Atlantic white-sided dolphin	 1 - 25
● Common bottlenose dolphin	 26 - 50
● Common dolphin	 51 - 100
● Harbor porpoise	 101 - 200
● Long-finned pilot whale	 201 - 500
● Sperm whale	 501 - 1000

Sources

1. Odontoceti data extracted on 7/22/2020 from the Ocean Biodiversity Information System Spatial Ecological Analysis of Megavertebrate (OBIS-SEAMAP).
2. Base map: USGS The National Map

Date	12/18/2020 Revised: 6/1/2021
Project Number	2028113199
Prepared By	EE
Reviewed By	GC

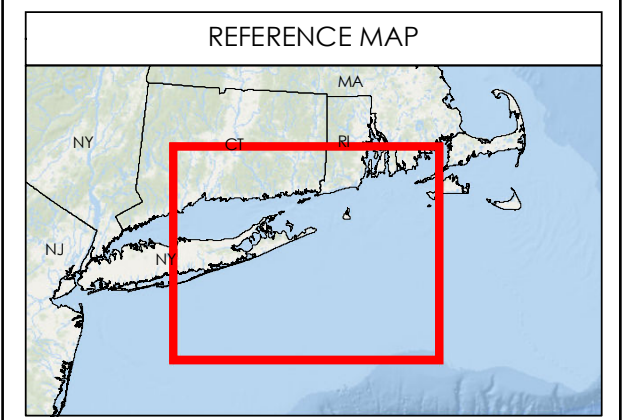
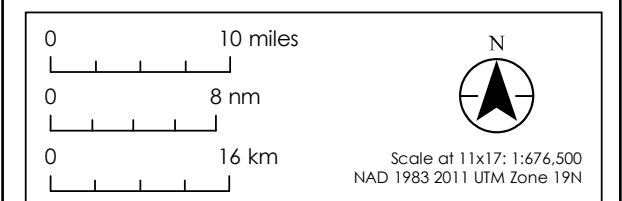

This page intentionally left blank

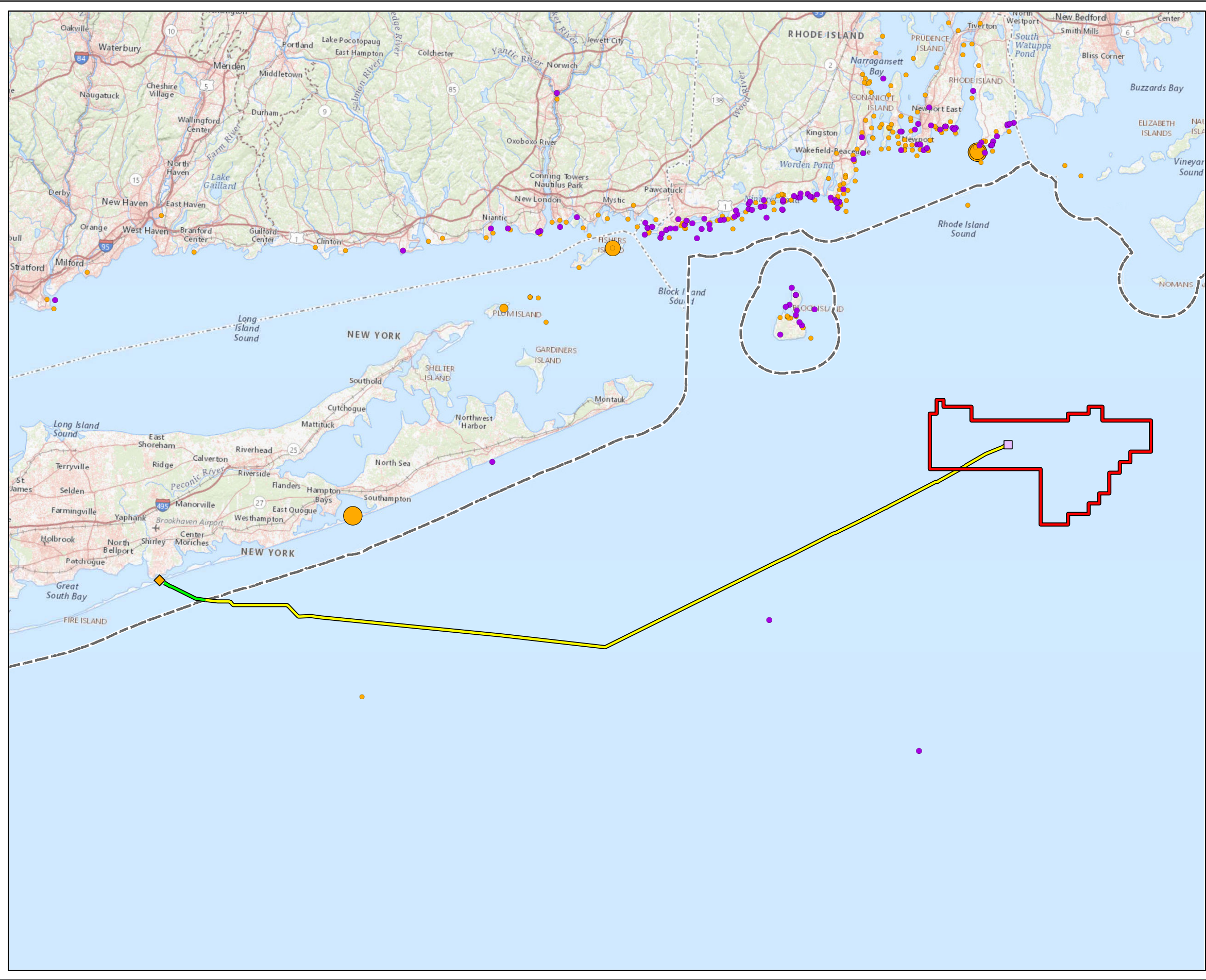

Figure 4.4.4-3
OBIS-SEAMAP Seal Sightings Data
 1979 – 2019

Sunrise Wind | Powered by Ørsted & Eversource

Legend

- Sunrise Wind Farm (SRWF)
- Offshore Converter Station (OCS-DC)
- ◆ SRWEC Landfall Location
- Sunrise Wind Export Cable (SRWEC-OCS)
- Sunrise Wind Export Cable (SRWEC-NYS)
- 3-nm State Waters Boundary

Seal Sighting Counts

Gray seal

- 1

Harbor seal

- 1
- 2 - 5
- 6 - 10
- 11 - 20
- 21 - 40

Sources

1. Pinniped data extracted on 7/22/2020 from the Ocean Biodiversity Information System Spatial Ecological Analysis of Megavertebrate (OBIS-SEAMAP).
2. Base map: USGS The National Map

Date	12/18/2020 Revised: 6/1/2021
Project Number	2028113199
Prepared By	EE
Reviewed By	GC

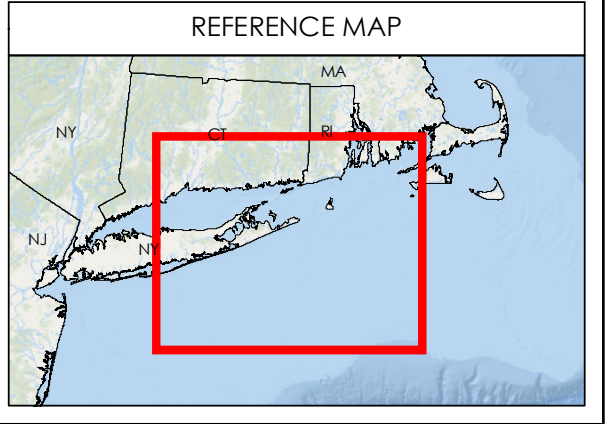
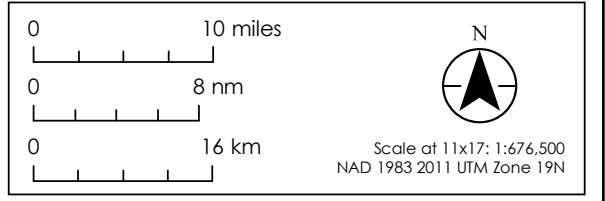

This page intentionally left blank

CONSTRUCTION AND OPERATIONS PLAN

Site Characterization and Assessment of Impacts – Biological Resources

Table 4.4.4-1 Marine Mammals Potentially Occurring Within the Regional Waters of the Western North Atlantic OCS and Project Area

Species	Stock	Current Listing Status	Best Population Estimate ^a	Relative Occurrence in the SRWF	Relative Occurrence in the SRWEC OCS	Relative Occurrence in the SRWEC NYS	Relative Occurrence in the Onshore Facilities
Suborder Mysticeti (Baleen Whales)							
Blue whale (<i>Balaenoptera musculus</i>)	Western North Atlantic	ESA Endangered MMPA Depleted NY State Endangered MA State Endangered	402	Uncommon	Uncommon	Not Expected	Not Expected
Fin whale (<i>Balaenoptera physalus</i>)	Western North Atlantic	ESA Endangered MMPA Depleted NY State Endangered RI State SGCN MA State Endangered	7,418	Common	Common	Common	Not Expected
Humpback whale (<i>Megaptera novaeangliae</i>)	Gulf of Maine	MMPA Depleted NY State Endangered MA State Endangered	1,396	Common	Common	Common	Not Expected
North Atlantic right whale (<i>Eubalaena glacialis</i>)	Western North Atlantic	ESA Endangered MMPA Depleted NY State Endangered RI State SGCN MA State Endangered	428	Common	Common	Common	Not Expected
Sei whale (<i>Balaenoptera borealis</i>)	Nova Scotia ^b	ESA Endangered MMPA Depleted NY State Endangered MA State Endangered	6,292	Regular	Regular	Uncommon	Not Expected
Minke whale (<i>Balaenoptera acutorostrata</i>)	Canadian Eastern Coast	NA	24,202	Common	Common	Common	Not Expected

CONSTRUCTION AND OPERATIONS PLAN

Site Characterization and Assessment of Impacts – Biological Resources

Species	Stock	Current Listing Status	Best Population Estimate ^a	Relative Occurrence in the SRWF	Relative Occurrence in the SRWEC OCS	Relative Occurrence in the SRWEC NYS	Relative Occurrence in the Onshore Facilities
Suborder Odontoceti (Toothed Whales, Dolphins and Porpoises)							
Sperm whale (<i>Physeter catodon</i>)	North Atlantic	ESA Endangered MMPA Depleted NY State Endangered MA State Endangered	4,349	Regular	Regular	Uncommon	Not Expected
Pygmy sperm whale (<i>Kogia breviceps</i>)	Western North Atlantic	NA	7,750 ^c	Rare	Rare	Rare	Not Expected
Dwarf sperm whale (<i>Kogia sima</i>)	Western North Atlantic	NA		Rare	Rare	Rare	Not Expected
Northern bottlenose whale (<i>Hyperoodon ampullatus</i>)	Western North Atlantic	NA	Unknown	Not Expected	Not Expected	Not Expected	Not Expected
Cuvier's beaked whale (<i>Ziphius cavirostris</i>)	Western North Atlantic	NA	21,818	Rare	Rare	Rare	Not Expected
Mesoplodont beaked whales (<i>Mesoplodon spp</i>)	Western North Atlantic	NA	21,818	Rare	Rare	Rare	Not Expected
Killer whale (<i>Orcinus orca</i>)	Western North Atlantic	MMPA Depleted	Unknown	Rare	Rare	Rare	Not Expected
False killer whale (<i>Pseudorca crassidens</i>)	Western North Atlantic	MMPA Depleted	1,791	Rare	Rare	Rare	Not Expected
Pygmy killer whale (<i>Feresa attenuata</i>)	Western North Atlantic	NA	Unknown	Not Expected	Not Expected	Not Expected	Not Expected
Short-finned pilot whale (<i>Globicephala macrorhynchus</i>)	Western North Atlantic	NA	28,924	Rare	Rare	Rare	Not Expected
Long-finned pilot whale (<i>Globicephala melas</i>)	Western North Atlantic	NA	39,215	Common	Uncommon	Uncommon	Not Expected

CONSTRUCTION AND OPERATIONS PLAN

Site Characterization and Assessment of Impacts – Biological Resources

Species	Stock	Current Listing Status	Best Population Estimate ^a	Relative Occurrence in the SRWF	Relative Occurrence in the SRWEC OCS	Relative Occurrence in the SRWEC NYS	Relative Occurrence in the Onshore Facilities
Melon-headed whale (<i>Peponocephala electra</i>)	Western North Atlantic	NA	Unknown	Not Expected	Not Expected	Not Expected	Not Expected
Risso's dolphin (<i>Grampus griseus</i>)	Western North Atlantic	NA	35,493	Uncommon	Uncommon	Uncommon	Not Expected
Short-beaked common dolphin (<i>Delphinus delphis</i>)	Western North Atlantic	NA	178,825	Common	Common	Common	Not Expected
Fraser's dolphin (<i>Lagenodelphis hosei</i>)	Western North Atlantic	NA	Unknown	Rare	Rare	Rare	Not Expected
Atlantic white-sided dolphin (<i>Lagenorhynchus acutus</i>)	Western North Atlantic	NA	93,233	Common	Common	Common	Not Expected
White-beaked dolphin (<i>Lagenorhynchus albirostris</i>)	Western North Atlantic	NA	536,016	Rare	Rare	Not Expected	Not Expected
Pantropical spotted dolphin (<i>Stenella attenuata</i>)	Western North Atlantic	NA	6,593	Rare	Rare	Rare	Not Expected
Clymene dolphin (<i>Stenella clymene</i>)	Western North Atlantic	NA	4,237	Not Expected	Not Expected	Not Expected	Not Expected
Striped dolphin (<i>Stenella coeruleoalba</i>)	Western North Atlantic	NA	67,036	Rare	Rare	Rare	Not Expected
Atlantic spotted dolphin (<i>Stenella frontalis</i>)	Western North Atlantic	NA	39,921	Regular	Uncommon	Uncommon	Not Expected
Spinner dolphin (<i>Stenella longirostris</i>)	Western North Atlantic	MMPA Depleted	4,102	Rare	Rare	Rare	Not Expected
Rough toothed dolphin (<i>Steno bredanensis</i>)	Western North Atlantic	NA	136	Rare	Rare	Rare	Not Expected

CONSTRUCTION AND OPERATIONS PLAN

Site Characterization and Assessment of Impacts – Biological Resources

Species	Stock	Current Listing Status	Best Population Estimate ^a	Relative Occurrence in the SRWF	Relative Occurrence in the SRWEC OCS	Relative Occurrence in the SRWEC NYS	Relative Occurrence in the Onshore Facilities
Common bottlenose dolphin (<i>Tursiops truncatus</i>)	Western North Atlantic, offshore	MMPA Depleted	62,851	Common	Common	Common	Not Expected
	Western North Atlantic, Northern migratory coastal	MMPA Depleted	6,639	Rare	Rare	Uncommon	Not Expected
Harbor porpoise (<i>Phocoena phocoena</i>)	Gulf of Maine/ Bay of Fundy	RI State SGCN	95,543	Common	Common	Common	Not Expected
Suborder Pinnipedia							
Harbor seal (<i>Phoca vitulina</i>)	Western North Atlantic	NY State SC RI State SGCN	75,834	Regular	Regular	Regular	Rare
Gray seal (<i>Halichoerus grypus</i>)	Western North Atlantic	NA	27,131	Regular	Regular	Regular	Rare
Harp seal (<i>Pagophilus groenlandicus</i>)	Western North Atlantic	NA	Unknown	Rare	Rare	Uncommon	Rare
Hooded seal (<i>Cystophora cristata</i>)	Western North Atlantic	NA	Unknown	Rare	Rare	Uncommon	Rare
Order Sirenia							
Florida manatee (<i>Trichechus manatus</i>)	Sirenian	ESA Threatened MMPA Depleted	Unknown	Rare	Rare	Rare	Not Expected

CONSTRUCTION AND OPERATIONS PLAN

Site Characterization and Assessment of Impacts – Biological Resources

Species	Stock	Current Listing Status	Best Population Estimate ^a	Relative Occurrence in the SRWF	Relative Occurrence in the SRWEC OCS	Relative Occurrence in the SRWEC NYS	Relative Occurrence in the Onshore Facilities
<p>NOTES:</p> <p>a/ The latest NOAA Fisheries Stock Assessments for each species were used for estimated populations (NOAA Fisheries 2020c)</p> <p>b/ Although there is a Western North Atlantic stock of sei whales, no population estimates have been conducted within the last ten years, therefore population cannot be properly estimated; however, whales from the Nova Scotia stock may be present within offshore waters, and recent population estimates of this stock have been made, therefore Nova Scotia population estimates have been provided.</p> <p>c/ Population estimate includes both species of Kogia combined because they are difficult to differentiate at sea, per NOAA Fisheries 2020c</p> <p>d/ It is not possible per the data available to determine the minimum population estimate of only the Mesoplodon beaked whales; therefore, the minimum population estimate is for the undifferentiated complex of beaked whales (both Ziphius and Mesoplodon spp.), per NOAA Fisheries 2020c</p> <p>KEY:</p> <p>ESA = <i>Endangered Species Act</i></p> <p>MA = <i>Massachusetts State</i></p> <p>MMPA = <i>Marine Mammal Protection Act</i></p> <p>NA = species is not federally listed, is not designated as depleted under the MMPA, is not state-listed in New York, Rhode Island, or Massachusetts, and is not considered a Rhode Island SGCN.</p> <p>NY = <i>New York State</i></p> <p>RI = <i>Rhode Island State</i></p> <p>SC = <i>Species of Concern</i></p> <p>SGCN = <i>Species of Greatest Conservation Need</i></p> <p>Sources: NOAA Fisheries n.d.[a], 2019b, 2020b; Normandeau and APEM 2019; Tetra Tech and LGL 2020; Sadove and Cardinale 1993</p>							

CONSTRUCTION AND OPERATIONS PLAN

Site Characterization and Assessment of Impacts – Biological Resources

Regional Effects of Climate Change on Distributions of Marine Mammals

Anticipated direct impacts of climate change on the marine environment include an increase in temperature, a rise in sea levels, and a decrease in sea-ice cover (Learmonth et al. 2006). These changes are likely to have both direct and indirect effects on marine mammals (MacLeod 2009). Some studies show a greater effect predicted on porpoises than large whales (MacLeod 2009), and other studies show vulnerable whale populations may be greatly affected (Greene and Pershing 2004). North Atlantic right whales may be especially vulnerable since they are critically endangered and have a more specialized feeding preference (copepods). North Atlantic right whale reproductive rates in the Gulf of Maine have been specifically linked to the abundance of copepods, as shown by Meyer-Gutbrod et al. (2015), and copepod size and abundance have been shown to significantly decrease due to warming sea temperatures, causing concern for higher trophic levels (Garzke et al. 2014). Climate change in the marine environment is not wholly new, and marine mammals have likely been subject to changing conditions historically; however, the current rate of change is a higher magnitude stressor.

The anticipated primary direct impacts on marine mammals from climate change-related stressors in this region of the world are changes in prey availability or abundance and changes to the existing physical habitat. Other anticipated stressors are potential increases in toxin exposure, higher rates of pathogen transmission and (pathogen) survival rates, more susceptibility to disease by hosts (marine mammals), and mismatching of breeding cycles with prey abundance cycles, which would impact migrating marine mammals since they travel long distances between feeding and breeding grounds. These effects are in turn expected to have direct or indirect impacts on marine mammals such as altering known ranges of marine mammal distributions or changing species abundance (MacLeod 2009). Ranges may undergo expansion, contraction, or even elimination. It is also possible in some cases that range changes may be beneficial if, for example, a species increases in distribution or abundance.

Indirect effects include changes to availability, locality, and abundance of food sources, which affects health and animal distributions or population numbers. Changes in food sources also indirectly affect reproductive success (Simmonds and Elliot 2009). Shifts in groundfish species have already occurred, with groundfish moving farther north and into deeper waters (Nye et al. 2009; Pinsky et al. 2013) while other species are shifting southward, including the Atlantic cod which is a historically dominant prey species in the Atlantic Ocean (Selden et al. 2018). Sea temperature changes may result in an additional indirect effect on animal health as pathogen transmission becomes more prevalent as body condition deteriorates (Simmonds and Elliot 2009). Additional discussion of the potential effects of climate change on marine mammals is presented in Appendix O). Although no single renewable energy project can reverse the direction of climate change, the Project will contribute to the cumulative reduction in the use of fossil fuels that are associated with increased ocean temperatures and other large-scale changes in climate.

CONSTRUCTION AND OPERATIONS PLAN

Site Characterization and Assessment of Impacts – Biological Resources

Sunrise Wind Farm

Mysticete whales have been observed in all seasons in the SRWF during visual and acoustic surveys conducted in the northeast region and Rhode Island/Massachusetts Wind Energy Area (RI-MA WEA) and Massachusetts WEA (MA WEA) and adjacent to New York State (Kenney and Vigness-Raposa 2010; Kraus 2018; Kraus et al. 2016; NOAA Fisheries 2019c, 2020b; Palka et al. 2017; Smultea Sciences 2019, 2020; Tetra Tech and LGL 2020). Increased presence was observed in the winter and spring, generally correlating with migratory patterns for these species. Species with more pelagic distributions such as the sei whale and blue whale have fewer observations in the SRWF but may be encountered primarily during winter and spring months (Kenney and Vigness-Raposa 2010; Kraus et al. 2016; NOAA Fisheries 2019c; Tetra Tech and LGL 2020). Three years of New York Bight Whale Monitoring Aerial Surveys (2017-2020) conducted by Tetra Tech and LGL Ecological Research Associates for the NYSDEC Whale Monitoring Program identified sightings of blue whales (five individuals), fin whales (207 individuals), humpback whales (279 individuals), North Atlantic right whales (24 individuals), and sei whales (seven individuals) within the New York Bight (Tetra Tech and LGL 2020). Although blue whale sightings occurred in water past the OCS, the fin, humpback, North Atlantic right, and sei whale sightings occurred in waters surrounding the SRWF with some sightings also extending into nearshore, coastal waters.

Endangered North Atlantic right whales have been observed in the RI-MA and MA WEAs and SRWF during the winter and spring but have the potential to occur within the waters off New York, Massachusetts, and Rhode Island any time of the year (Kraus et al. 2016; Kraus 2018). The Muskeget Channel and south of Nantucket, both located adjacent to the SRWF, were identified as right whale hotspots during the spring (Kraus et al. 2016). Furthermore, during Sunrise Wind G&G surveys from 2019 to 2020 (Smultea 2020), the fin whale, humpback whale, and North Atlantic right whale were detected both within and outside the SRWF.

Deeper-diving odontocete whales (i.e., the sperm whale) are expected to have a regular occurrence in the SRWF and, in recent surveys, were primarily observed during the summer and fall (Kraus et al. 2016; Palka et al. 2017). During the 2017-2020 New York Bight Whale Monitoring Aerial Surveys, 72 sperm whale individuals were sighted; however, these sightings occurred in federal waters past the OCS. During Sunrise Wind G&G surveys, the Atlantic spotted dolphin and short-beaked common dolphin were detected both within and outside the SRWF. Odontocete dolphin and porpoise species do not typically undergo extensive seasonal migrations like mysticetes. However, most display some seasonality in movements, and some species such as the common bottlenose dolphin, Atlantic white-sided dolphin, and short-beaked common dolphin have shown predictable migrations between the northeast and Mid-Atlantic regions (Hayes et al. 2019). Survey data suggest odontocete species could be present in the SRWF year-round with a peak presence during the summer months when water temperatures in this region are higher (Kenney and Vigness-Raposa 2010; Kraus et al. 2016; Palka et al. 2017). Long-finned pilot whales, Risso's dolphins, and Atlantic spotted dolphins are known to prefer deeper waters offshore. While these species have been sighted within the RI-MA WEA and waters off Block Island, and may thus be encountered in the SRWF, occurrence is still generally expected to be uncommon, with the highest likelihood in the spring (Kenney and Vigness-Raposa 2010; Kraus et al. 2016; Palka et al. 2017). Harbor porpoises are also common in this region and are expected to occur predominantly in the winter and spring (Kenney and Vigness-Raposa 2010).

CONSTRUCTION AND OPERATIONS PLAN

Site Characterization and Assessment of Impacts – Biological Resources

Harbor and gray seals are known to occur in New England waters near New York, Massachusetts, and Rhode Island. The closest known pupping grounds are located in Nantucket Sound at Monomoy and Muskeget Island, east of the SRWF (NOAA Fisheries 2020d). Breeding for these species occurs in open waters predominantly between spring and fall (Temte 1994). These species have been sighted in Southern New England between Long Island, NY and Vineyard Sound, MA and are known to inhabit this region year-round, with increased presence in winter and spring. During Sunrise Wind G&G surveys, both the gray and harbor seals were detected within and outside the SRWF.

Sunrise Wind Export Cable–OCS

Like in the SRWF, mysticete whales have been observed in all seasons in the SRWEC–OCS during visual and acoustic surveys conducted in the northeast region and waters off New York, extending from 15 nm (17.3 mi, 27.8 km) off the coast of Long Island to the continental shelf break, slope, and into oceanic waters to a depth of 8,202 ft (2,500 m) (NYSERDA 2017; Smultea Sciences 2019, 2020; Tetra Tech and LGL 2020). Aside from North Atlantic right whales, densities of mysticetes were highest in spring and summer with the greatest predicted occurrence on the shelf break and continental slope (NYSERDA 2017). Use of the shelf break and slope was driven in part by spring and fall humpback whale migration through this area but also by use of this region in spring by sei and minke whales and year-round use by fin whales. Overall, the low-frequency cetaceans are likely to be using the continental slope more than the shelf, and most species show increased spring use corresponding to migration, although similar increases are not apparent in fall, with the exception of humpback whales (NYSERDA 2017).

Survey data suggest odontocete species could be present in the SRWEC–OCS year-round with a peak presence during the summer months when water temperatures in this region are higher (Kenney and Vigness-Raposa 2010; Kraus et al. 2016; NYSEDA 2017; Palka et al. 2017; Smultea Sciences 2019, 2020; Tetra Tech and LGL 2020). Long-finned pilot whales, Risso's dolphins, and Atlantic spotted dolphins, are known to prefer deeper waters offshore but have been sighted within the RI-MA and MA WEAs and waters off Block Island, so it is likely they will be encountered in the SRWEC–OCS, primarily in the spring (Kenney and Vigness-Raposa 2010; Kraus et al. 2016; Palka et al. 2017; Smultea Sciences 2019, 2020). Harbor porpoises are common in this region and are expected to occur predominantly in the winter and spring (Kenney and Vigness-Raposa 2010; Smultea Sciences 2019, 2020).

Sunrise Wind Export Cable–NYS

Marine mammals most commonly seen in New York waters during all seasons include harbor porpoise, bottlenose dolphin, humpback whale, fin whale, harbor seal, and gray seal, with occasional visits from sei and North Atlantic right whales (Kenney and Vigness-Raposa 2010; NYSDEC 2020; Tetra Tech and LGL 2020).

The NYSDEC Whale Monitoring Program collects data on large whales to allow for robust estimates of spatio-temporal densities and seasonal abundance (NYSDEC 2021). The Whale Monitoring Program also identifies seasonal and inter-annual variabilities, records data on whale behavior, and identifies areas of particular importance to these species and how/when they are used (NYSDEC 2021). As a part of the Whale Monitoring Program, NYSDEC partnered with Tetra Tech Inc., Smultea Environmental Sciences, LGL Ecological Research Associates, and Aspen

CONSTRUCTION AND OPERATIONS PLAN

Site Characterization and Assessment of Impacts – Biological Resources

Helicopters, Inc. to conduct aerial line-transect surveys from March 2017 to February 2020. A total of 36 monthly aerial surveys (263 survey flights) were conducted within the New York OPA (Tetra Tech and LGL 2020), which covers a 12,668 nm² (16,776 mi², 43,449 km²) area from the south shore of Long Island to the continental shelf break. Aerial surveys were focused around six species of large whales: blue, fin, humpback, North Atlantic right, sei, and sperm whale. Results showed that humpback whales and fin whales were the most commonly sighted species (111 sightings/279 estimated individuals and 124 sightings/207 estimated individuals, respectively) from 2017-2020. Although the full New York OPA survey area includes both deep and nearshore waters, review of spatial data (per figures within Tetra Tech and LGL 2020) illustrates that humpback and fin whales were still the most commonly sighted marine mammals within nearshore waters. Whales documented during the 2017-2020 surveys were sighted in all seasons, with the most sightings occurring during the spring and summer months.

As stated above, odontocete species could be present in the SRWEC–NYS year-round, with a peak presence during the summer months when water temperatures in this region are higher (Kenney and Vigness-Raposa 2010; Kraus et al. 2016, NYSERDA 2017; Palka et al. 2017; Tetra Tech and LGL 2020). Seal species inhabit the cooler waters of the northeast and frequent the waters and inland areas around Long Island. Harbor and gray seals are known to move generally southward in the fall from the Bay of Fundy to northeastern US coastal waters, particularly in southern New England waters, although they are considered to be generally non-migratory (Barlas 1999; Waring et al. 2010). Harbor and gray seals are common in New York waters year-round, with increased presence in winter and spring. Breeding for these species occurs in open waters, predominantly between spring and fall (Temte 1994).

The only marine mammals that can regularly be found onshore in this region are seals. No pupping areas are located in New York and the closest known pupping grounds are located in Nantucket Sound at Monomoy and Muskeget Island, to the northeast of the SRWF (NOAA Fisheries 2020d). There are about 30 known Long Island haulout sites, which are scattered around the eastern end of Long Island and along both sides of the Atlantic and Long Island Sound shores (CRESLI 2020; Kenney and Vigness-Raposa 2010). From 2019 to 2021, the AMCS has documented approximately four harbor and/or gray seal haulout sites along the Atlantic coastline of Long Island, with more scattered within Long Island Sound and off the coast of Rhode Island (AMCS 2021; R. DiGiovanni Jr., personal communication, March 9, 2021). Seals are most likely to be encountered at low tide, with harbor and gray seals occurring seasonally along the New Hampshire to New Jersey coastline from September to late May (Barlas 1999; Hoover et al. 1999; Slocum et al. 1999; DiGiovanni and Sabrosky 2010; NYSDEC n.d.). Furthermore, seal watching activities on the northeast US coastline are most prevalent from December through mid-April in NYS (DiGiovanni and Sabrosky 2010). Within the last three years, seals have been sighted along the Fire Island National Seashore, Cupsogue Beach County Park, Montauk Point State Park, and Smith Point County Park (Long Island Pulse 2017; Newsday 2020). In November 2018, an aerial survey of haulout sites around Long Island, Connecticut, and Rhode Island was conducted by the AMCS to support a UME investigation. During this survey, more than 900 harbor and gray seals were observed (AMSC 2021).

CONSTRUCTION AND OPERATIONS PLAN

Site Characterization and Assessment of Impacts – Biological Resources

The most localized estimates of populations residing within the Long Island Sound harbors come from CRESLI, having observed nearly 16,000 harbor seals over 302 seal observation trips from 2007 through 2017 around Cupsogue Beach, during which CRESLI found the highest monthly concentrations of seals from December through April, with abrupt declines in May. And, during Project-specific PSO surveys from 2019 to 2020 (Smultea 2020), three estimated individuals were detected inside the SRWF, and four estimated individuals were detected outside the Lease Areas, as illustrated in Appendix O, Figure 3.1-6.

Although harbor seals are the most frequently observed, gray seals also regularly occur on Long Island. Important haulouts in Long Island include Fishers Island, Great Gull Island, Montauk Point, Gardiners Island, and Sag Harbor (Kenney and Vigness-Raposa 2010). Seals can and do haulout on a wide variety and range of terrestrial habitats (both natural and anthropogenic) and may be encountered during landfall construction activities.

Onshore Facilities

The Onshore Transmission Cable will be routed across the ICW via HDD. As previously described (and further detailed in Appendix O), some marine mammals, including the harbor porpoise, bottlenose dolphin, harbor seal, and gray seal, have been sighted in nearshore New York waters (CRESLI 2020; Kenney and Vigness-Raposa 2010; NYSDEC 2020) and may access the ICW via openings in the barrier island. The harbor seal, gray seal, minke whale, and bottlenose dolphin have been specifically documented within the adjacent Great South Bay (USFWS n.d.). However, the portion of the ICW that will be crossed by the Onshore Transmission Cable is a geographically small, pinched and shallow area, and most of the larger species of whale potentially occurring in New York coastal waters such as the humpback whale, sei whale, fin whale, and North Atlantic right whale are not expected.

4.4.4.2 Potential Impacts

Construction, O&M, and decommissioning activities associated with the SRWF, SRWEC, and Onshore Facilities have the potential to cause both direct and indirect impacts on marine mammals. IPFs associated with the construction and O&M phases of the Project are identified in Figure 4.4.4-4 and described separately, by phase, in the following sections. For the decommissioning phase of the Project, impacts are anticipated to be similar to or less adverse than those described for construction; therefore, impacts from decommissioning are not addressed separately in this section. Supporting information on impacts to marine mammals are also presented in Appendices I1 and O. Sunrise Wind proposes to implement construction and operational measures to avoid, minimize, or mitigate adverse impacts on marine mammals (Section 4.4.4.3), and measures that enhance protection of marine mammals are also considered in the analysis of impacts to marine mammals.

The ESA protects endangered and threatened species and their habitats by prohibiting the “take” of listed animals. Under the ESA, to “take” a listed endangered or threatened species is to harass, harm, pursue, hunt, shoot, wound, kill, trap, capture, or collect, or to attempt to engage in any such conduct. The regulations also define harm as an act that kills or injures wildlife. Similarly, the MMPA prohibits the “take” of marine mammals, which is defined under the MMPA as the harassment, hunting, or capturing of marine mammals, or the attempt thereof.

CONSTRUCTION AND OPERATIONS PLAN

Site Characterization and Assessment of Impacts – Biological Resources

“Harassment” is further defined as any act of pursuit, annoyance, or torment, and is classified as Level A (potentially injurious to a marine mammal or marine mammal stock in the wild) and Level B (potentially disturbing a marine mammal or marine mammal stock in the wild by causing disruption to behavioral patterns). The ESA and MMPA work to control harm, takes, and harassment of all federally listed (ESA) or other (MMPA) marine mammals occurring within US Exclusive Economic Zone waters.

Potential impacts associated with the construction and O&M of the Project that could result in “take” as defined by the ESA or MMPA include:

- Direct mortality, injury, or disturbance due to vessel movement or vessel strike (i.e., traffic IPF)
- Direct mortality or injury from entanglement (i.e., trash and debris, and traffic IPFs)
- Disturbance of or displacement from habitat (i.e., seafloor disturbance, sediment suspension and deposition, lighting and marking, and visible infrastructure IPFs) and potential associated changes in prey availability
- Direct or indirect effects from changes in water quality due to contamination or spills (i.e., discharges and releases IPF)
- Disturbance or hearing injury from Project-related noise (i.e., noise IPF)
- Direct or indirect effects from EMF (i.e., EMF IPF)

CONSTRUCTION AND OPERATIONS PLAN

Site Characterization and Assessment of Impacts – Biological Resources

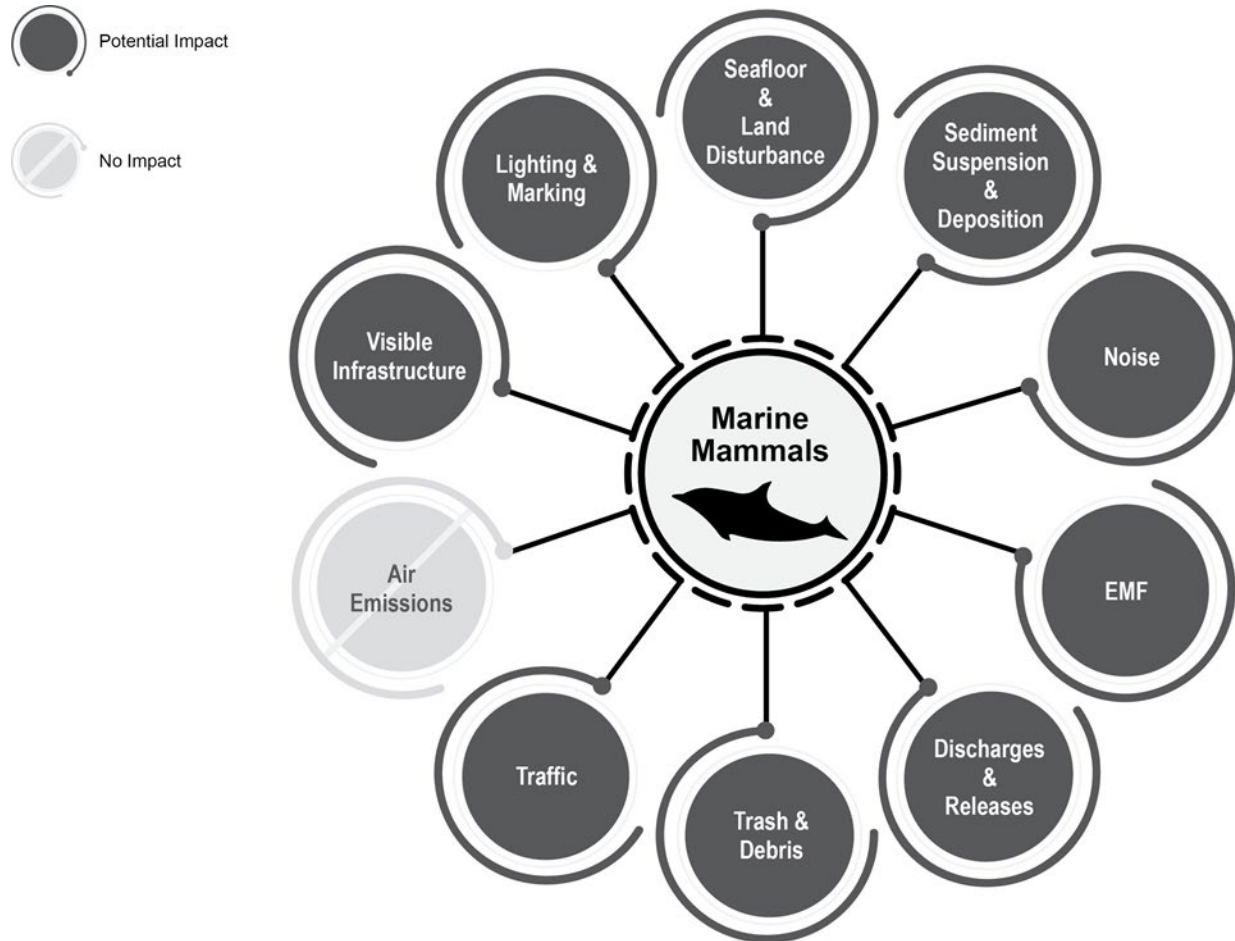

Figure 4.4.4-4 Impact-Producing Factors on Marine Mammals

During construction, marine mammals may experience the following IPFs: seafloor disturbance, sediment suspension and deposition, noise, discharges and releases, trash and debris, vessel traffic, and lighting and marking. During O&M, marine mammals may experience all these same IPFs as well as EMF and visible infrastructure. The potential impacts associated with each phase of the Project are addressed in the following sections.

Sunrise Wind Farm

Construction

Seafloor Disturbance

During construction of the SRWF, seafloor disturbances would be associated with seafloor preparation, foundation installation, vessel anchoring and jack-up, placement of scour protection/cable protection, and IAC installation. During each of these activities, limited seafloor disturbance will occur. Table 3.3.5-2 describes the maximum seafloor disturbance for each of the three possible foundation types.

CONSTRUCTION AND OPERATIONS PLAN

Site Characterization and Assessment of Impacts – Biological Resources

Many species of marine mammal in the SRWF are likely to be transiting the area in search of prey species. Schooling fish and zooplankton (e.g., krill or copepods) are the predominant prey items for most marine mammals; however, some species will also forage for benthic fish and invertebrates. Multiple mysticete species have been observed feeding on sand lance (*Ammodytes* spp.) including humpback whales and minke whales; humpbacks, in particular, are known to follow aggregations of this prey species (Friedlaender et al. 2009). Odontocete species such as Atlantic spotted dolphins, common bottlenose dolphins, and harbor porpoises have also been observed feeding on species on or near the seafloor (Halpin et al. 2009). Seals' diets primarily consist of fish, shellfish, and crustaceans; seals may also forage along the seafloor.

Marine mammals foraging within the SRWF during construction may therefore encounter a localized reduction in foraging opportunities due to the temporary disturbance or displacement of prey species. As further detailed in Section 4.4.3, mobile fish species are expected to temporarily relocate from the area immediately surrounding seafloor-disturbing activities; however, because prey would still be available within the overall region surrounding the SRWF, impacts would be limited to short-term, temporary effects to individual marine mammals and not groups or populations. Prey aggregations may even increase within the SRWF after construction, as described below under Visible Infrastructure during O&M of the Project.

Sediment Suspension and Deposition

As discussed in Section 4.2.2, seafloor preparation activities, foundation installation, placement of scour protection/cable protection, vessel anchoring and jack-up, sand wave leveling, and IAC installation will result in short-term, localized increases in sediment suspension in the SRWF. This suspended sediment would result in increased turbidity and decreased visibility and water quality in the immediate area surrounding the SRWF foundations and IAC. A change in habitat through sediment suspension and deposition could result in short-term reductions in availability of prey species, which in turn could have a short-term impact on marine mammal foraging success in low-visibility conditions.

Appendix H provides further information on suspended sediments from installation of the IAC in federal waters. As detailed in Sections 4.4.2 and 4.4.3, only short-term, limited impacts to benthic and shellfish resources and fish are expected from suspended sediments; therefore, secondary effects on marine mammal prey availability are not expected. Furthermore, Appendix H concluded that TSS concentrations are predicted to return to ambient levels (<10 mg/L) within 0.5 hours following completion of IAC installation. The TSS plumes were predicted to be primarily contained within the lower portion of the water column, approximately 12.8-ft (3.9-m) above the seafloor. These limited temporal effects over a relatively small area are not expected to interfere with marine mammal foraging success. Suspended sediments within the SRWF would therefore cause only temporary impacts to benthic habitats. Suspended sediments are not likely to have long-term adverse effects on prey species targeted for consumption by marine mammals in the SRWF, nor on the overall foraging success of marine mammals.

CONSTRUCTION AND OPERATIONS PLAN

Site Characterization and Assessment of Impacts – Biological Resources

Noise

Sources of underwater noise during the construction phase of the SRWF include G&G survey equipment, MEC/UXO surveys, impact pile driving, vessels, and air traffic. These are addressed separately in the subsections below, following a brief overview of the impacts and the relevant regulatory thresholds associated with underwater noise. Additional details are presented in Appendix I1. In-air noise during construction of the SRWF is not expected to result in measurable impacts to marine mammals beyond levels anticipated for underwater noise; therefore, the potential for in-air-noise impacts to marine mammals is not discussed further in this assessment.

Sound is important to marine mammals for communication, individual recognition, predator avoidance, prey capture, orientation, navigation, mate selection, and mother-offspring bonding. Most marine animals can perceive underwater sounds over a broad range of frequencies, from about 10 Hz to more than 10,000 Hz (10 kilohertz [kHz]). Many dolphins and porpoises use even higher-frequency sound for echolocation and perceive these sounds with high acuity (Richardson et al. 1995). Underwater noise could adversely impact marine mammals that are present within areas of elevated noise during SRWF construction activities.

Potential effects of anthropogenic noise on marine mammals can include behavioral modification (e.g., changes in foraging or habitat-use patterns), masking (the prevention of marine mammals from hearing sounds), and auditory injury. A temporary or reversible elevation in hearing threshold is termed a temporary threshold shift (TTS), while a permanent or unrecoverable reduction in hearing sensitivity is termed a permanent threshold shift (PTS). The occurrence and severity of impacts are uniquely dependent on environmental, physiological, and contextual factors. Acoustic modeling of construction-related underwater noise and prediction of potential impacts to marine mammals and their movement was completed, and results are presented in Appendix I1 and summarized below.

Recognizing that marine mammal species do not have equal hearing capabilities, marine mammals are separated into hearing groups (NOAA Fisheries 2018; Southall et al. 2007, 2019). Regulatory marine mammal hearing groups, originally identified by Southall et al. (2007) then later modified by Finneran (2016) and adopted by NOAA Fisheries (2018), are categorized as low frequency (LF) cetaceans, mid-frequency (MF) cetaceans, high frequency (HF) cetaceans, phocid pinnipeds in water (PPW), and otariid pinnipeds in water (OW).

Each category has a defined auditory weighting function and estimated acoustic threshold for the onset of PTS, as detailed in Appendix I1, Table 7. No species from the OW hearing group (i.e., eared seals) are expected to occur in the Project Area and, therefore, are not discussed further.

To account for these hearing groups, frequency-weighting functions are applied when determining physiological thresholds to scale a species' sensitivity to a received sound depending on the spectral content of that sound. In effect, sound energy contained within the frequency hearing range of an animal has the potential to affect hearing, while sound energy outside an animal's frequency hearing range is unlikely to affect its hearing. The overall objective in defining hearing groups and deriving frequency weighting functions is to better define the role that frequency content plays in potential auditory injury.

CONSTRUCTION AND OPERATIONS PLAN

Site Characterization and Assessment of Impacts – Biological Resources

More recently, Southall et al. (2019) conducted a broad, structured assessment of the audiometric, and physiological bases for the categorization of marine mammal hearing groups. Southall et al. (2019) kept the same frequency responses (hearing sensitivities) but re-categorized the LF, MF, and HF hearing groups to LF, HF (previously MF), and very high frequency (VHF) (previously HF) hearing groups, and distinguished between phocid carnivores (i.e., pinnipeds) in water (PCW) and in air (PCA). Their assessment also indicated a probable distinction within the baleen whales to include a very-low frequency and a LF group, and an additional distinction among many of the odontocetes to include a distinction of an MF group containing the beaked, killer, and sperm whales from other HF cetaceans. There is insufficient evidence to support these distinctions, so the broader LF and HF hearing group categories are currently used, resulting in a total of five possible groups as outlined in Appendix I1, Table 6. Southall et al. (2019) further acknowledged that there are presently insufficient direct data within the HF and VHF groups to explicitly derive distinct thresholds and weighting functions; they proposed retaining the thresholds and functions developed by Finneran (2016) and adopted by NOAA Fisheries (2018), but with slightly different categorical identifiers. The results of Southall et al. (2019) remain congruent with the current existing regulatory guidance (NOAA Fisheries 2018).

In addition to variability in marine mammal hearing sensitivities, current scientific understanding recognizes that different sound source types do not equally affect species in the same manner, particularly when considered in the context of accumulated sound levels. For example, repeated exposure to sounds is potentially more damaging as it increases the accumulation of received sound necessary to meet TTS or PTS. Southall et al. (2007) identified two main types of sound sources, impulsive and non-impulsive, which are further classified into operational categories such as continuous or intermittent. Within each sound source and hearing group, onset threshold levels are identified depending on the group-specific hearing capabilities and how they relate to the resulting potential for TTS and PTS. Impulsive noise exposures result in TTS and PTS at lower accumulated sound levels than non-impulsive sounds given their rapid onset and broadband nature. Consequently, they are subject to dual thresholds (Southall et al. 2007; Finneran 2016; NOAA Fisheries 2018) (see Appendix I1).

In addition to physiological threshold criteria and impacts (Level A harassment), separate acoustic thresholds were established by NOAA Fisheries (2012) for behavioral impacts (Level B harassment) on marine mammals from impulsive and non-impulsive noise. Agency-adopted behavioral acoustic thresholds use root-mean-square sound pressure level (SPL) values that are not weighted by frequency, so criteria are assumed to apply to all marine mammal species and are not differentiated by hearing group. Table 4.4.4-2 outlines these acoustic threshold limits for marine mammal behavioral impacts. Although frequency weighting is applied to these criteria for comparison in the acoustic modeling report (Appendix I1), the unweighted thresholds were used in the marine mammal impact assessment provided here, because they have a regulatory foundation. While it is acknowledged that weighted thresholds may be a more appropriate impact metric, the current review status for behavioral acoustic criteria and lack of regulatory basis for weighted values at this time warrant the use of the unweighted metrics for this analysis.

CONSTRUCTION AND OPERATIONS PLAN

Site Characterization and Assessment of Impacts – Biological Resources

Table 4.4.4-2 Summary of NOAA Fisheries (2012) Behavioral Onset Acoustic Threshold Criteria for Impulsive and Non-Impulsive Sounds

Sound Source Type	Behavioral Threshold Criteria ¹
Impulsive	SPL: 160 dB re 1 μ Pa
Non-impulsive	SPL: 120 dB re 1 μ Pa

NOTE:
¹ Unlike physiological onset acoustic threshold criteria, behavioral onset threshold criteria were not developed for each marine mammal hearing group; criteria are assumed to apply to all marine mammal species.

The determination of how, when, and to what degree marine mammals are exposed to underwater noise that could result in a physiological and/or behavioral impact is complex. The analysis completed to inform this impact evaluation considered underwater sound propagation based on several operational assumptions, marine mammal densities specific to the SRWF, marine mammal movement modeling, and the context within which marine mammals may be exposed to Project-related noise. Due to the contextual nature of acoustic impacts, marine mammal species in the vicinity of the SRWF during underwater noise-generating activity were not automatically assumed to sustain exposures that would equate to an adverse impact. Rather, potential physiological and behavioral impacts on marine mammals were assessed based on rigorous methods using the best available data and models, as discussed below and in greater detail in Appendix I1.

The primary sources of underwater noise that could be generated by the Project during construction of the SRWF are discussed below.

Impulsive Sound—Geophysical Surveys

Short-term, localized HRG surveys during the construction period may include the use of multi-beam echosounders, side-scan sonars, shallow penetration sub-bottom profilers, medium penetration sub-bottom profilers, and marine magnetometers. The survey equipment to be employed will be equivalent to the equipment utilized during the HRG survey campaigns associated with Lease Area OCS-A 0500 conducted in 2016, 2017, 2018, 2019, and 2020 and with Lease Area OCS-A 0487 conducted in 2018, 2019, and 2020 (CSA Ocean Sciences Inc 2020). Site-specific verification has been conducted of all geophysical equipment sound sources deployed within the marine portions of the Project Area that operate within the functional hearing range of marine mammals.

Impulsive Sound – MEC/UXO Clearance Surveys

As detailed in Section 3.3.3.4, prior to seafloor preparation, cable routing, and micrositing of all assets, the Project will implement a MEC/UXO Risk Assessment with RARMS designed to evaluate and reduce risk in accordance with the ALARP risk mitigation principle. The RARMS consists of a phased process beginning with a Desktop Study and Risk Assessment that identifies potential sources of MEC/UXO hazard based on charted MEC/UXO locations and historical activities, assesses the baseline (pre-mitigation) risk that MEC/UXO pose to the Project, and recommends a strategy to mitigate that risk to ALARP. Appendix G2 presents this study and strategies.

CONSTRUCTION AND OPERATIONS PLAN

Site Characterization and Assessment of Impacts – Biological Resources

Avoidance is the preferred approach for MEC/UXO mitigation; however, it is anticipated that there may be instances where confirmed MEC/UXO avoidance is not possible due to layout restrictions, presence of archaeological resources, or other factors that preclude micrositing. In such situations, confirmed MEC/UXO may be removed through in-situ disposal or physical relocation. Selection of a removal method will depend on the location, size, and condition of the confirmed MEC/UXO and will be made in consultation with a MEC/UXO specialist and in coordination with the appropriate agencies.

In-situ disposal will be done with low noise methods like deflagration of the MEC/UXO or cutting the MEC/UXO up to extract the explosive components. The MEC/UXO might also be relocated through a “Lift and Shift” operation; the relocation will be to another suitable location on the seabed within the APE or previous designated disposal areas for either wet storage or disposal through low noise methods as described for in situ disposal. For all MEC/UXO clearance methods, safety measures such as the use of guard vessels, enforcement of safety zones, and others will be identified in consultation with a MEC/UXO specialist and the appropriate agencies and implemented as appropriate.

During Project construction, the likelihood of MEC/UXO encounter is very low. Sunrise Wind will work with BOEM to identify appropriate response actions, which may include developing an emergency response plan, conducting MEC/UXO-specific safety briefings, retaining an on-call MEC/UXO consultant, or other measures (See Appendix G2 for additional detail).

Impulsive Sound—Impact Pile Driving

Underwater noise generated by impact pile driving is considered one of the predominant IPFs that could result in potential physiological and behavioral impacts on marine mammals due to the relatively high source levels produced by impact pile driving and the large distances over which the noise is predicted to propagate. The acoustic propagation model predicts sound fields for a 24-hour period, or a specific scenario, which includes consideration of the hammer energies required to drive the pile from start to finish, as well as the silent periods between two consecutive piles (if applicable in the impact pile driving scenario), and any proposed noise mitigation measures.

As part of the Appendix I1 modeling study, impacts to marine mammals, sea turtles, and fish were assessed. Within this assessment, the JASCO Animal Simulation Model Including Noise Exposure (JASMINE) was utilized to predict the probability of exposure of animals to sound arising from pile driving operations during construction activities. Simulated animals (animats) were used to sample predicted three-dimensional sound fields derived from animal movement observations. Predicted sound fields were sampled so that animats were programmed to behave like marine species are expected to, and the output provided an exposure history for each animat included within the simulation. Both SPL_{pk} and SEL_{cum} were calculated for each species based on corresponding acoustic criteria.

CONSTRUCTION AND OPERATIONS PLAN

Site Characterization and Assessment of Impacts – Biological Resources

Appendix I1 additionally provides modeled sound propagation distances based on expected construction scenarios associated with the PDE such as hammer type, pile type, pile schedule (hammer energy, number of strikes, piling duration), season, geographic location, and implementation of noise mitigation (i.e., sound attenuation) measures. The acoustic ranges to the SEL_{cum} physiological threshold assume an animal is stationary within the propagated sound field and thus that it accumulates noise levels for the full 24-hour period. When realistic animal behavior and movement are considered, the predicted risk of exposure to accumulated noise levels with the potential to cause a physiological impact is lower. As evidenced by the variable monthly densities of marine mammals in the SRWF, seasonality is also an important parameter when estimating exposures and impacts from potential sources of underwater noise.

Distances to the SEL_{cum} physiological onset thresholds that take animal movement into account are called exposure-based distances. Because marine mammals are not expected to be stationary in the area during construction, the exposure-based distances are considered a more realistic prediction of distances to the threshold criteria provided in Appendix I1 when compared to the acoustic ranges in which sound propagation is estimated based on a stationary receiver (i.e., animal).

The exposure-based distances to SEL_{cum} physiological onset thresholds indicate LF and HF cetaceans may face a higher risk of exposure to noise sufficient to elicit physiological impacts, compared to MF and PPW species. However, the SEL_{cum} threshold assumes an animal experiences accumulated noise above the threshold level for 24 hours. When animal movement and behavior are taken into account, the risk of physiological impacts on marine mammals is low, since it is not expected that an animal will remain within the area ensonified by above-threshold underwater noise for the entire piling period. However, it should be noted that some species (baleen whales in particular) transiting and socializing within the area may not be deflected by noise if there is prevalent forage available.

The most likely impact expected during impact pile driving is behavioral disturbances given the estimated threshold distances for all marine mammal species. These distances reflect the expected attenuation achieved using noise mitigation devices employed by Sunrise Wind, the implementation of mitigation measures (Appendix I1), and the variability in source levels as the pile reaches target penetration depth. Behavioral thresholds are not differentiated by hearing group, and the SPL metric used for these criteria does not account for the duration of exposure like the SEL_{cum} metric. Therefore, the exposure-based modeling method is not appropriate for behavioral impact criteria, and distances are therefore estimated by modeling the propagation of impact pile driving noise through the water column. However, behavioral responses are highly contextual, and exposure to underwater noise above the prescribed impact threshold does not alone indicate an impact.

Seasonal increases in species' densities within the SRWF could increase the risk of more individuals being exposed to underwater noise levels that exceed physiological and behavioral disturbance thresholds. ESA-listed marine mammal species with already low population estimates would be most vulnerable to impacts during their corresponding peak density periods. Depending on the species stock and the acoustic exposure characteristics, Project activities could result in direct impacts; however, impacts would largely be stock-specific and not based solely on a species' listing status.

CONSTRUCTION AND OPERATIONS PLAN

Site Characterization and Assessment of Impacts – Biological Resources

In the case of North Atlantic right whales, potential injury or substantial behavioral disturbance are more likely to incur long-term effects on the population given their low abundances in the Western North Atlantic; therefore, impact determinations would be elevated for this species. ESA-listed species with more stable or increasing stocks and non-ESA listed species have a greater resilience from potential population-level impacts. Impacts to these less-vulnerable groups could be expected if the proposed activity resulted in injury or significant behavioral disturbance during peak seasonal density periods. However, injury or significant behavioral disturbance is not expected, and the implementation of the environmental protection measures and development of a protected species mitigation and monitoring plan will further reduce the overall risk of exposure to noise above threshold levels.

Non-impulsive Sound—Vessel Noise

Commercial and recreational vessels can produce varying SPLs dependent on the overall size, engine, propeller size, and configuration. Vessels expected to be present during construction of the SRWF, as outlined in Sections 3.3.9.4 and 4.8.1, include construction barges, support tugs, jack-up rigs, supply/crew vessels, and cable laying vessels. Given the Project location relative to major commercial shipping lanes, a significant disruption to the normal traffic pattern from construction of the SRWF is not anticipated. The projected number of vessels operating for construction of the SRWF is expected to result in only a temporary increase in Project-related traffic, with underwater noise expected to be similar to existing vessel-related underwater noise levels in the area. As detailed in Table 3.3.10-3, 43 vessels are estimated to support SRWF construction activities; however, not all vessels associated with construction activities will be deployed at one time. Construction is also anticipated to take place within specified work windows, which will limit the number of vessels added to the local traffic levels at one time. Therefore, it is presumed that individuals or groups of marine mammals in the area are familiar with various and common vessel-related noises and will not be further impacted by incremental Project-related vessel traffic.

Studies on behavioral responses to anthropogenic noise clearly indicate that animals will show variable responses to noise dependent on species, behavioral contexts, and the distance of animals to the sound source (Ellison et al. 2012). Responses to vessel disturbances can include behaviors such as changes to their vocalizations, surface time, swimming speed, swimming angle or direction, respiration rates, dive times, feeding behavior, and social interactions (Au and Green 2000). In a study by Matthews et al. (2020), vessel noise was found to overlap with breeding vocalizations of harbor seals, where seals in Glacier Bay National Park and Preserve, Alaska did not adjust source levels or acoustic parameters of vocalizations to sufficiently compensate for acoustic masking. For every 1 dB increase in ambient noise, harbor seal signals decreased by 0.84 dB, indicating a reduction in communication that could potentially impact breeding success (Matthews et al. 2020).

Potential disruptions in behavior or communication or temporary displacement are expected to be short-term. However, it is likely that underwater noise from existing anthropogenic activities occurring in the region would be indiscernible from incremental Project-related underwater noise from vessel traffic, making it uncertain if marine mammals would experience behavioral impacts as a result of Project activities or the level of potential existing habituation to vessel noise.

CONSTRUCTION AND OPERATIONS PLAN

Site Characterization and Assessment of Impacts – Biological Resources

Non-impulsive Sound—Aircraft

Helicopters may be used for crew changes during installation of the SRWF. Helicopters will generally fly at altitudes above those that would potentially result in behavioral effects. In cases where the helicopter must fly below these altitudes to land, take off, or inspect Project components, any behavioral effects to marine mammals, including ESA-listed whales, would be direct and immediate with no long-term effects to individuals or populations. All aircraft activities will comply with current approach regulations for any sighted North Atlantic right whales or unidentified marine mammals. Additional details on helicopter operations can be found in Sections 3.3.9.4, 3.5.5, and 4.8.1, and in Appendix X.

Discharges and Releases

Accidental discharges and releases represent a risk factor to marine mammals because marine mammals could potentially ingest, inhale, or have their fur or baleen fouled by contaminants. Marine mammal exposure to aquatic contaminants and inhalation of fumes from oil spills can result in mortality or sublethal effects on the individual fitness, including adrenal effects, hematological effects, liver effects, lung disease, poor body condition, skin lesions, and several other health effects attributed to oil exposure (Mohr et al. 2008; Sullivan et al. 2019; Takeshida et al. 2017).

Project-related marine vessels operating during construction will be required to comply with regulatory requirements for management of onboard fluids and fuels including prevention and control of discharges. Trained, licensed vessel operators will adhere to navigational rules and regulations, and vessels will be equipped with spill containment and cleanup materials. Additionally, Sunrise Wind will comply with applicable international (IMO MARPOL), federal (USCG), and state (NY) regulations and standards for reporting treatment and disposal of solid and liquid wastes generated during all phases of the Project. As described in Appendix E1, some liquid wastes will be permitted as discharge into marine waters (i.e., domestic water, deck drainage, treated sump drainage, uncontaminated ballast water, and uncontaminated bilge water); these are not expected to pose an adverse impact to marine resources as they will quickly disperse, dilute, and biodegrade (BOEM 2013).

All vessels will similarly comply with USCG standards regarding ballast and bilge water management. Liquid wastes from vessels (including sewage, chemicals, solvents, and oils and greases from equipment) will be properly stored, and disposal will occur at a licensed receiving facility. As required by 30 CFR 585.626, chemicals to be utilized during the Project are provided in Appendix E1, and in Table 3.3.1-2 and Table 3.3.6-2. Any unanticipated discharges or releases are expected to result in minimal, temporary impacts; activities are heavily regulated, and unpermitted discharges are considered accidental events that are unlikely to occur. In the unlikely event that a reportable spill were to occur, the National Response Center would be notified, followed by the EPA, BOEM, and USCG, as outlined in Appendix E1.

CONSTRUCTION AND OPERATIONS PLAN

Site Characterization and Assessment of Impacts – Biological Resources

Trash and Debris

Any active vessel operating within a marine environment has the potential to create trash and debris. However, the discharge or disposal of solid debris into offshore waters from OCS structures and vessels is prohibited by BOEM (30 CFR 250.300) and the USCG (MARPOL, Annex V, Pub. L. 100-220 [101 Stat. 1458]). In accordance with applicable federal, state, and local laws, Sunrise Wind will implement comprehensive measures prior to and during Project construction activities to avoid, minimize, and mitigate impacts related to trash and debris disposal. All trash and debris will be properly stored on vessels for later disposal on land at an appropriate facility per 30 CFR 585.626(b)(9). Trash and debris will be contained on vessels and offloaded at port or construction staging areas. Food waste that has been ground and can pass through a 1-in (25-mm) mesh screen may be disposed of according to 33 CFR 151.51-77.

All other trash and debris returned to shore will be disposed of or recycled at licensed waste management and/or recycling facilities. Disposal of any other form of solid waste or debris in the water will be prohibited, and good housekeeping practices will be implemented to minimize trash and debris in vessel work areas. These practices will include orderly storage of tools, equipment, and materials, as well as proper waste collection, storage, and disposal to keep work areas clean and minimize potential environmental impacts. With proper waste management procedures, the potential for trash or debris to be inadvertently left overboard or introduced into the marine environment is not anticipated.

Inadvertent releases of trash or debris into the water can lead to marine mammal injury or mortality via entanglement or the ingestion of foreign materials. Worldwide, approximately 50 percent of marine mammal species have been documented ingesting marine litter (Werner et al. 2016), and stranding data indicate potential debris-induced mortality rates of 0 to 22 percent. Mortality has been documented in cases of debris interactions as have blockage of the digestive track, disease, injury, and malnutrition (Baulch and Perry 2014). Entanglement in trash or debris could occur if marine mammals are caught, ensnared, or restrained by strong, flexible, man-made materials such as fishing line or buoy lines. Most recently, on July 27, 2020, a humpback whale was reported entangled in fishing gear in the Ambrose Channel, New York; a four-day effort was launched to safely untangle the whale (NOAA Fisheries 2020e). Within the marine portions of the Project Area, the North Atlantic right whale is known to be particularly sensitive to entanglement.

Project vessels with anchor lines, cables, and other equipment have the potential to entangle marine mammals when left unattended in the water. The lines that will be deployed in support of the Project will be associated with the cable plow/ trencher towing cables and umbilicals. While most scientific studies have focused on entanglement as bycatch (Henry et al. 2020), recent work explored the entanglement risk to marine wildlife from offshore renewable developments (Benjamins et al. 2012; Harnois et al. 2015; Reeves et al. 2013). The key parameters used in these risk assessments were tension characteristics, line swept volume ratio, and line curvature of moorings. These assessments concluded that taut configurations present a low risk of entanglement to all marine mammals. Similarly, plow cables/umbilicals will be under constant tension, and in this taut condition represent a far reduced entanglement risk. If a line or cable is lost, it would then present a higher risk to species entanglement, with the potential for a prolonged impact on the individual, including mortality.

CONSTRUCTION AND OPERATIONS PLAN

Site Characterization and Assessment of Impacts – Biological Resources

However, best management practices, such as those presented in Section 4.4.4.3, should prevent loss of lines and cables, and no entanglement is expected due to vessel activities during SRWF construction.

Vessel Traffic

Project installation is scheduled to take place over a one- to two-year period (see Section 3.2.2). The largest vessels are expected during the WTG installation phase, with floating/jack-up crane barges, cable-laying vessels, supply/crew vessels, and associated tugs and barges transporting construction equipment and materials. Large work vessels for foundation and WTG installation will generally transit to the work location and remain in the area until installation is complete. These large vessels will generally move slowly and over short distances between work locations. Construction activities will also require the support of several smaller, faster moving vessels (e.g., CTV and other small supply vessels) that will move continuously throughout the SRWF. Sunrise Wind is evaluating the potential use of several existing port facilities located in New York, Connecticut, Maryland, Massachusetts, New Jersey, Rhode Island, and Virginia to support offshore construction, assembly and fabrication, crew transfer and logistics. Potential ports expected to be utilized by construction of the SRWF are summarized in Table 3.3.10-3, which identifies 14 vessel types (with 43 vessels total) proposed for SRWF construction activities. However, not all vessels associated with construction activities will be deployed at one time. Appendix K provides further details, along with estimated vessel trips per construction activity.

Appendix X shows existing traffic conditions in the assessment area (defined as the largest practical footprint of Sunrise Wind offshore structures within the Lease Area), based on one year of AIS data (July 2018 through June 2019), and collected from 28 transects. Results showed that most transects have very low traffic levels of less than 10 transits per day (i.e., less than 3,650 transits per year). However, two transects showed comparatively higher levels of traffic, each with an average of 35 to 38 transits per day (13,000 per year). Results also showed seasonal differences in existing traffic levels, with the highest traffic levels occurring in the summer. As detailed in Sections 3.3.9.4 and 4.8.1, and Appendix X, Project-related traffic is expected to result in only a temporary increase in existing traffic at any given point in time. However, non-Project related traffic is also expected to increase, as traffic that may be generated by the presence of the SRWF could result in approximately 100 additional recreational vessels per year (Appendix X). Effects of vessel noise are addressed under the noise IPF above; the following assessment focuses on the potential risk and impacts of vessel strikes.

Vessel strikes occur when marine mammals and vessels fail to detect one another and collide, causing injury and/or mortality to the marine mammal. Vessel strikes are a growing issue for some marine mammal species and have the potential to result in population-level effects when it comes to particularly vulnerable species such as the North Atlantic right whale (Conn and Silber 2013; Laist et al. 2001; Van der Hoop et al. 2013; Van Waerebeek et al. 2007). Variables that contribute to the likelihood of a collision include vessel speed, vessel size and type, visibility, and barriers to vessel detection by an animal (e.g., acoustic masking, heavy traffic, biologically focused activity). Research indicates that most vessel collisions that result in serious injury or death to marine mammals occur at speeds of more than 14 knots (25.9 km/h) and with vessels that are 262 ft (80 m) or greater in size, while there is a statistically significant reduction in lethal ship strike at speeds below 10 knots (18.5 km/h) (Conn and Silber 2013; Laist et al. 2001; Van der Hoop et al. 2013).

CONSTRUCTION AND OPERATIONS PLAN

Site Characterization and Assessment of Impacts – Biological Resources

Vanderlaan and Taggart (2007) found the probability of a strike resulting in mortality increased from 20 to 100 percent at speeds between 9 and 20 knots (16.7 and 37 km/h), and that lethality from ship strike increased from 35 to 40 percent at 10 knots (18.5 km/h), 45 to 60 percent at 12 knots (22.2 km/h), and 60 to 80 percent at 14 knots (25.9 km/h). Studies showed that increased vessel speed also increased the hydrodynamic draw of vessels, which could result in North Atlantic right whales being pulled toward vessels, making them more vulnerable to collisions (Conn and Silber 2013). Conn and Silber's (2013) assessment of lethality of ship strikes showed an 80 to 90 percent decrease in total ship strike mortality risk level during vessel speed restriction periods. Two well-documented North Atlantic right whale vessel strikes incurred by marine mammal research vessels demonstrated that even with expert observation, ideal sea state conditions, and vigilant crews, the speed of the vessel combined with sometimes cryptic behavior of the whale presents a clear risk for vessel strikes (Wiley et al. 2016).

Of the species most likely to occur in the SRWF, the six large whale species (North Atlantic right whale, humpback whale, fin whale, sei whale, minke whale, and sperm whale) are the most prone to vessel strike. Incidences of strike for these large whales tend to be higher than other marine mammals due to their large size, slower movements and travel (for some species), breathing patterns (longer surface respiration bouts), lengthy surface rest periods, long-range movements during migrations, and feeding patterns which for most of the large whales (excluding right whales) typically include periods of surface lunges (Dolman et al. 2006; Henry et al. 2020). North Atlantic right whales are particularly prone to ship strike and disturbance for these reasons (Cates et al. 2019). Smaller dolphin and seal species (such as harbor porpoise, Atlantic white-sided dolphins, short-beaked common dolphin, bottlenose dolphins, long-finned pilot whales, harbor seals, and gray seals) are less vulnerable to ship strike due to their agility in the water, generally smaller surface area, and ability for rapid avoidance responses (Glass et al. 2009; Jensen and Silber 2003; Laist et al. 2001; van der Hoop et al. 2015).

The 2018 US Atlantic and Gulf of Mexico Marine Mammal Stock Assessment (Hayes et al. 2019) accounts that between 2012 and 2016, there were a reported annual average of 2.6 vessel collisions with humpback whales in the Gulf of Maine stock, 1.4 collisions with fin whales in the Western North Atlantic stock, 0.8 collisions with sei whales in the Nova Scotia stock and 1.0 collision with minke whales in the Canadian East Coast stock. Furthermore, in the latest US Atlantic and Gulf of Mexico Marine Mammal Stock Assessment (Hayes et al. 2020), between 2013 and 2017, the average annual vessel collisions of the same species and stocks were greater for the humpback whale (4.4 per year), less for the fin whale (0.8 per year), and the same for sei and minke whales (0.8 and 1.0, respectively) (Hayes et al. 2020).

In 2016, a high number of humpback whale mortalities on the Atlantic coast prompted NOAA Fisheries' Office of Protected Resources to declare an Unusual Mortality Event (UME) (NOAA Fisheries 2020f). As of the last reported online update of December 3, 2020, 140 humpback whales were found dead along the Atlantic coast from Maine to Florida including 31 off New York (Henry et al. 2020; NOAA Fisheries 2020f). Of the carcasses that have been examined, approximately 50 percent have shown signs of human interaction, either vessel strike or entanglement.

CONSTRUCTION AND OPERATIONS PLAN

Site Characterization and Assessment of Impacts – Biological Resources

Similarly, since January 2017, a high number of minke whale mortalities along the Atlantic coast prompted NOAA Fisheries to declare a UME (NOAA Fisheries 2020g). NOAA Fisheries, in collaboration with the Working Group on Marine Mammal UMEs, is working to review collected data on these events, as findings were not consistent across whales examined. From January 2017 through December 3, 2020, a total of 16 minke whales were stranded off the coast of NYS, with an overall total of 102 strandings from South Carolina to Maine (NOAA Fisheries 2020g).

The level of vessel strikes between 2016 and 2017 was more than six times the 16-year average for this region (NOAA Fisheries 2019c). On July 17, 2020, a humpback whale was recorded stranded approximately 6 mi (9.7 km) offshore near Montauk, and on July 18, 2020, another humpback whale was reported to the NYS Stranding Hotline by a vessel conducting G&G surveys for the Project (AMCS 2020). The whale washed ashore that evening at Smith Point County Park. The whale recorded offshore was not autopsied; however, the beached whale's head tissues were examined and were found to be consistent with vessel strike trauma (AMCS 2020).

For North Atlantic right whales, vessel strikes pose a significant risk to the species' survival, mainly due to their small population size, behavioral characteristics, and habitat preferences that make them highly susceptible to vessel encounters. Vessel strike is consistently one of the most common causes of North Atlantic right whale mortality annually (Cates et al. 2019; Hayes et al. 2019). The Ship Strike Reduction Rule (50 CFR § 224.105) mandates a speed restriction of 10 knots (18.5 km/h) or less between November 1 and April 30 in the right whale SMAs. These restrictions apply to all vessels greater than or equal to 65 ft (20 m) in overall length and subject to US jurisdiction as well as all other vessels greater than or equal to 65 ft (20 m) in overall length entering or departing a port or place subject to US jurisdiction. North Atlantic right whale ship strike deaths in US waters averaged about one per year during the 18 years documented before the 2008 rule; and less than half of that (i.e., 0.47 deaths per year) in the nine years that followed it (Marine Mammal Commission 2020).

In 2017, there were five confirmed ship strike mortalities of North Atlantic right whales (four in Canadian waters and one in US waters off Nantucket, MA), likely caused by right whales occurring in areas without speed restrictions and increased vessel traffic (Henry et al. 2020; NOAA Fisheries 2019c). In June 2017, NOAA initiated a UME for North Atlantic right whale (NOAA Fisheries 2020h) due to the significant increase in mortalities. According to NOAA Fisheries' Office of Protected Resources (last updated online on December 4, 2020), from 2017 to 2020, a total of 32 dead stranded North Atlantic right whales (21 in Canada and 11 in the US) have been confirmed, with the leading cause of death being human interaction from entanglements and/or vessel strikes (NOAA Fisheries 2020h). Thirteen other non-stranded North Atlantic right whales were documented as seriously injured during this timeframe, bringing the estimated total up to 45 individual whales, assuming a "serious injury" is likely to lead to eventual mortality (NOAA Fisheries 2020h). The most recent of these losses include a calf that was identified off Elberon, NJ in June 2020 with evidence of sharp and blunt force trauma (i.e., suggestive of vessel strike) (NOAA Fisheries 2020h). The endangered status and small population size of the North Atlantic right whale stock make it more vulnerable to impacts from the perspective of negative population consequences, particularly those resulting in possible injury or mortality, which could result in removal of an individual from an already critically small stock. Potential impacts to this population would likely be more severe than other marine mammal species, so it is considered more carefully in this assessment.

CONSTRUCTION AND OPERATIONS PLAN

Site Characterization and Assessment of Impacts – Biological Resources

In addition to the potential for strike, the presence of vessel traffic can be a stressor to marine mammals. Many studies have documented short-term responses in whales to both vessel noise (discussed above) and vessel traffic (Baker et al. 1983; Magalhães et al. 2002; Watkins et al. 1986). It is, however, often difficult to determine whether a marine mammal exhibiting a behavioral change is responding to the physical presence of the vessel itself, to the noise generated by the vessel, or to some unknown and potentially unrelated but synchronous factor, such as proximity to “conspecifics” (other animals of the same species), predators (killer whales), vocalizations from other animals, normal shifts in behavioral states, or other human-induced factors. Reactions also may vary depending on context, such as the reproductive (e.g., presence of calves) or behavioral (e.g., foraging versus migrating) states of the individual. Potential effects of underwater noise from vessel traffic are discussed in greater detail under the noise IPF above.

Within the SRWF and surrounding areas, potential risk to marine mammals from strike and disturbance from Project-related vessels will be greatest during the construction phase. Based on the ship rules previously described, ship speeds for vessels greater than 65 ft (20 m) may be limited during certain time periods or in certain areas. Sunrise Wind will comply with the current NOAA Fisheries speed restrictions at the time of Project activities. To monitor the number of vessels and traffic patterns for analysis and compliance with vessel speed requirements, all vessels associated with the Project will be required to have operational AIS. Furthermore, the increased monitoring for marine mammals that will be part of this Project will provide a beneficial effect by supporting adaptive mitigation and increasing situational awareness for vessels in the area.

In the unlikely event a vessel strike was to occur during Project construction that resulted in mortality or serious injury impacts to the most vulnerable ESA-listed species (e.g., the North Atlantic right whale), the impact could result in population-level effects. Impacts to less vulnerable ESA-listed species and non-ESA listed species from vessel strikes may result in injury or mortality of individuals; however, mortality impacts are expected to be less likely to result in population-level effects. With the implementation of environmental protection measures (see Section 4.4.4.3), the risk of vessel strikes to marine mammals during the construction period will be reduced.

Lighting and Marking

Artificial lighting during SRWF construction will be associated with navigational and deck lighting on vessels from dusk to dawn. It is likely that reaction of marine mammals to this artificial light is species-dependent and may include attraction or avoidance of an area. Artificial lighting may disrupt the diel migration of some prey species, which may secondarily influence marine mammal distribution patterns. Observations at offshore oil rigs showed dolphin species foraging near the surface and staying for longer periods of time around platforms that were lit (Cremer et al. 2009). Only a limited area around Project-related vessels will be lit, relative to the surrounding unlit open ocean areas, therefore impacts to marine mammals are considered minimal and short-term during construction.

Operations and Maintenance

IPFs resulting in potential impacts on marine mammals in the SRWF area during the O&M phase are seafloor disturbance, sediment suspension and deposition, noise, EMF, discharges and releases, trash and debris, vessel traffic, visible infrastructure, and lighting and marking.

CONSTRUCTION AND OPERATIONS PLAN

Site Characterization and Assessment of Impacts – Biological Resources

Seafloor Disturbance

Seafloor disturbance during O&M will primarily result from vessel anchoring and jack-up and any maintenance activities that will require exposing and reburying the IAC. These activities are expected to be non-routine events and are not expected to occur with any regularity. It is likely that pelagic and mobile benthic prey species present near the SRWF during any maintenance activities will temporarily avoid the area in which activities are occurring, and zooplankton species may face localized, temporary displacement. However, any alterations to marine mammal prey distributions are expected to occur over a small scale and a short period. The potential beneficial impacts of the long-term presence of prey species in the SRWF are discussed in further detail below under Visible Infrastructure.

Sediment Suspension and Deposition

Any maintenance activities that will require exposing and reburying the IAC, and the use of vessel anchoring and jack-up may result in increases in sediment suspension and deposition, which may temporarily increase turbidity in the water column. These activities are expected to be non-routine events and are not expected to occur with any regularity. As discussed for the construction phase, sediment suspension and deposition could result in short-term reductions in availability or detectability of marine mammal prey species, but are not likely to have long-term adverse effects on prey species targeted for consumption by marine mammals in the SRWF, nor on the overall foraging success of marine mammals.

Noise

Non-impulsive Sound—Wind Turbine Generator Noise

Operating WTGs produce mechanical noise that can transmit in the water column through the foundations, resulting in continuous underwater noise that is audible to marine mammals. The frequency and sound level generated from operating WTGs depends on WTG size, wind speed and rotation, foundation type, water depth, seafloor characteristics, and wave conditions (Cheesman 2016; English et al. 2017; HDR 2019) (Appendix O). The number of WTGs in the SRWF may present complex acoustic environments and potentially accumulative noise when assessed as a whole rather than as individual WTGs. Madsen et al. (2006) found that noise propagated from wind farms may be audible to LF cetaceans up to 21.4 mi (18.6 nm; 20 km) away before the sound levels reach an ambient SPL of 90 dB re 1 μ Pa; however, this was in an area with no masking influence from shipping traffic.

Notably, some marine mammal species (seals, MF cetaceans, HF cetaceans) may be attracted to operational wind farms for foraging and shelter (Hammar et al. 2010; Russell et al. 2014). Aggregation of marine mammals around operational wind farms may indicate noise levels are insufficient to elicit behavioral disturbances or that the animals become habituated to WTG noise (Teilmann and Carstensen 2012). Madsen et al. (2006) noted that due to the low sound pressure levels from WTGs, operations were unlikely to cause hearing impairment to marine mammals; however, the noise produced by wind farms and potential impacts should be assessed within the context of the surrounding acoustic environment. There is no published literature assessing long-term movement of baleen whales in and around offshore wind farms.

CONSTRUCTION AND OPERATIONS PLAN

Site Characterization and Assessment of Impacts – Biological Resources

While operational WTG noise will be present throughout the 25- to 35-year life of the Project, the severity of potential impacts to marine mammals during O&M will be less than during the construction phase as there is no potential for physiological impacts due to WTG noise (Madsen et al. 2006; Scheidat et al. 2011). During O&M, anticipated impacts would be limited to audibility and short-term, reversible behavioral responses such as changes in foraging, socialization or movement, or auditory masking, which could impact foraging and predator avoidance (MMS 2007).

Non-impulsive Sound – Vessel Noise

Throughout the operational life of the SRWF, Sunrise Wind expects to use a variety of vessels to support O&M including SOVs with deployable work boats (daughter craft), CTVs, jack-up vessels, and cable laying vessels. Project vessels will undergo routine maintenance trips between the SRWF and potential ports in New York and Rhode Island. Impacts from vessel use during O&M would be similar to those described for construction. Marine mammal individuals may experience direct, short-term, reversible behavioral disruptions due to the incremental contribution of O&M vessels at levels comparable to existing ambient vessel noise in the region.

Non-impulsive Sound – Aircraft

Sunrise Wind expects to use a hoist-equipped helicopter and may also use unmanned aircraft systems to support O&M. Access to the OCS–DC will be provided from a boat landing or potentially a helicopter with a helideck located onsite. The type and number of unmanned aircraft systems and helicopters will vary over the operational lifetime of the Project. Impacts from aircraft use during O&M would be similar to those described for construction. All aircraft activities will comply with current approach regulations for any sighted North Atlantic right whales or unidentified marine mammals. Additional details on helicopter operations can be found in Sections 3.3.9.4, 3.5.5, and 4.8.1, and Appendix X.

Impulsive Sound—G&G Surveys

Short-term, localized impacts from HRG surveys during O&M may occur from the use of multi-beam echosounders, side-scan sonars, shallow penetration sub-bottom profilers, medium penetration sub-bottom profilers and marine magnetometers. The indicative frequency of seafloor surveys during O&M is provided in Section 3.5. Site-specific verification has been conducted of all geophysical equipment sound source deployed within the marine portions of the Project Area that operate within the functional hearing range of marine mammals.

The survey equipment to be employed will be equivalent to the equipment utilized during the HRG survey campaigns associated with Lease Area OCS-A 0500 conducted in 2016, 2017, 2018, 2019, and 2020 and with Lease Area OCS-A 0487 conducted in 2019 and 2020 (CSA Ocean Sciences Inc. 2020).

CONSTRUCTION AND OPERATIONS PLAN

Site Characterization and Assessment of Impacts – Biological Resources

Electric and Magnetic Fields

Once energized, the Project cables will produce a magnetic field and an induced electric field that will decrease in strength rapidly with distance. A detailed description of EMF produced by Project cables is found in Section 4.2.4 and Appendix J1. For context, common household items, such as television sets, hair dryers, and electric drills, can emit EMF levels similar to or higher than those emitted by undersea power cables associated with offshore wind energy projects (Snyder et al. 2019). There will be no EMF emissions from the OCS-DC themselves; however, several cables come into this structure and the cables will emit EMF when energized.

Three major factors determine the exposure of marine organisms to magnetic and induced electric fields from undersea power cables: 1) the amount of electrical current being carried by the cable, 2) the design of the cable, and 3) the distance between marine organisms and the cable. The magnetic fields will be strongest at the seafloor directly above the cable and will rapidly decrease with distance from the cables (Appendix J1). When EMF levels are detectable by marine life passing through this area, possible effects include a change in swim direction or migration routing (Gill and Kimber 2005).

Research suggests that marine species may be more likely to detect and react to magnetic fields from DC cables (such as those discussed for the SRWEC described below) than for AC cables (which will be used for the SRWF IAC) (Normandeau 2011). As detailed in Appendix J1, the magnetic fields and induced electric fields from operational AC cables will attenuate quickly with increasing distance.

Directly over the IAC at peak loading, AC magnetic- and induced electric-field levels were calculated to be 4.5 mG and < 0.1 mV/m, decreasing to 1.1 mG and < 0.1 mV/m or less at a horizontal distance of ± 10 ft (3 m) from the cables. Furthermore, previous literature on the subject (e.g., Hutchison et al. 2018; Silva et al. 2006) suggests the magnetic fields and induced electric fields would generally be lower than modeled in Appendix J1. Animals feeding on benthic prey species would have an increased potential for exposure, but the mobile nature and surfacing behavior in marine mammals likely limit time spent near cables. Surveys conducted at offshore windfarm sites indicate no adverse long-term impacts from AC cable, as species abundance recovered around the wind farms following construction activities (Normandeau 2011; Snyder et al. 2019).

Literature suggests cetaceans may sense the geomagnetic field and use it during migrations, although it is not clear which components they are sensing or how potential disturbances to the geomagnetic field caused by EMF near a buried AC cable may affect marine mammals (Normandeau 2011). There is no evidence indicating magnetic sensitivity in seals (Normandeau 2011), but other marine mammals appear to have a detection threshold for magnetic sensitivity gradients of 0.1 percent of the Earth's magnetic fields (Kirschvink 1990) and are likely to be sensitive to minor changes. Marine mammals may be able to detect geomagnetic cues for navigation based on reports of magnetite in the outer membrane of the brain and in the tongues and jawbones of some species (Normandeau 2011).

Appropriate cable protection and/or burial depths are anticipated to reduce potential EMF resulting from cable operation to low levels.

CONSTRUCTION AND OPERATIONS PLAN

Site Characterization and Assessment of Impacts – Biological Resources

Because marine mammals likely to occur within the SRWF would be transiting and foraging and would not spend significant time on the seafloor in proximity to the proposed cables, direct impacts on marine mammals from EMF would be unlikely. EMF are not generally considered to directly affect marine mammals. Any impacts such as change in swimming direction or altered migration routes are not anticipated to result in adverse effects to individual or population health.

Indirect effects on marine mammals from alterations in prey due to EMF are also unlikely as the average magnetic-field strengths of AC cables are far below levels documented to have adverse impacts to fish behavior (see Appendix J1). AC undersea power cables associated with offshore wind energy projects within the Southern New England area will generate weak EMF at frequencies outside the known range of detection by electrosensitive and magnetosensitive fishes (Normandeau 2011). Although induced electric fields from undersea cables may not directly mimic bioelectric prey, conspecifics, or predators, these resultant fields may affect the behavior of electrosensitive species. As detailed in Section 4.4.3, fish species, including small schooling fish (e.g., mackerel, herring, capelin), consumed by marine mammals, are not expected to be largely affected by the EMF associated with Project cables.

Seafloor Disturbance

Installation of the SRWEC will include the following activities: seafloor preparation, cable installation (including HDD in the nearshore portion of the SRWEC–NYS), installation of cable protection, and anchoring vessels. Seafloor disturbances associated with installation of the SRWEC may impact marine mammals by altering existing habitat and temporarily disrupting potential benthic prey species in the immediate area around the cable corridor centerline. As described for the SRWF, marine mammals occurring in the area may be foraging in search of prey species, which may occasionally be benthic species. After installation of the cable is complete, the habitat and displaced benthic communities are expected to return to near baseline conditions (see Section 4.4.2). Since not all marine mammals forage on benthic species and prey would be available outside the proposed SRWEC corridor, potential impacts are considered indirect, short-term, and minimal.

Discharges and Releases

Seawater cooling will be needed for the OCS–DC (Section 3.3.6.1). During operation, the OCS–DC will require continuous cooling water withdrawals and subsequent discharge of heated effluent back to the receiving waters. The maximum DIF and discharge volume is 8.1 million gallons per day with AIF and discharge volumes that are dependent on ambient source water temperature and facility output. Preliminary hydrodynamic modelling indicates that there will be some highly localized increases in water temperature in the immediate vicinity of the discharge location of the OCS–DC. The design, configuration, and operation of the CWIS for the OCS–DC will be permitted as part of an individual NPDES permit and additional details will be included in the permit application submitted to the EPA. This will include final results of the hydrodynamic modelling.

CONSTRUCTION AND OPERATIONS PLAN

Site Characterization and Assessment of Impacts – Biological Resources

Impacts from accidental discharges and releases during O&M are expected to be similar to, but of lesser likelihood than during, construction as there will be fewer Project-related marine vessels during this phase, and regulatory requirements and preventative measures will still apply. Unpermitted discharges or releases are considered accidental events, and, in their unlikely occurrence, these are expected to result in minimal, temporary impacts. Permitted discharges are not expected to pose an adverse impact to marine resources as they will quickly disperse, dilute, and biodegrade (BOEM 2013).

Trash and Debris

Impacts from Project-related marine disposal of trash and debris during O&M are expected to be similar to, but of lesser likelihood than during, construction as there will be fewer Project-related marine vessels during this phase, and regulatory requirements and preventative measures will still apply. The unanticipated marine disposal of trash and debris is considered an unpermitted, accidental event, and containment and good housekeeping practices will be implemented to minimize the potential.

Indirectly, there may be an increased number of commercial and recreational fishing vessels that operate around the SRWF, which could increase the occurrence of trash and debris from these vessels being released in the SRWF. This could also increase the potential entanglement risk from netted fishing gear, longlines, ropes, traps, or buoy lines. Although unlikely, there would be potential for entanglement or ingestion of line by marine mammals in the vicinity. Adverse impacts incurred from increased fishing activity in the SRWF are not anticipated, but in the event that a line or cable is lost, it could then present a higher risk to species entanglement including for the North Atlantic right whale. While such entanglements have the potential for a prolonged impact on the individual and may result in mortality, O&M of the SRWF is not expected to directly increase this risk.

Vessel Traffic

Sunrise Wind expects to use a variety of vessels to support O&M, including SOVs with deployable work boats (daughter craft), CTVs, jack-up vessels, and cable laying vessels. Section 3.5.5 provides a summary of O&M vessels currently being considered for support of O&M activities. Although the type and number of vessels will vary over the operational lifetime of the Project, five vessel types are currently being considered for O&M of the SRWF (three for routine activities and two for non-routine activities). There will be fewer vessels used for routine maintenance trips than for construction or non-routine maintenance, but they will occur over a longer period considering the 25- to 35-year operational life of the Project. During SRWF O&M activities, the SOV will remain within the SRWF for up to 28 days and will therefore not make daily trips to port; crew changes will occur every 14 days via CTVs. Potential ports expected to be utilized during O&M of the SRWF are detailed in Appendix K and in Section 4.7.

CONSTRUCTION AND OPERATIONS PLAN

Site Characterization and Assessment of Impacts – Biological Resources

Passenger vessels as well as O&M related vessels are likely to increase once the Project is operational as the WTGs are likely to increase public interest and the presence of recreational boaters in the area (as detailed in Appendix X). Within the SRWF, potential impacts to marine mammals during O&M include direct effects from vessel strike and behavioral disturbance, and indirect effects from increased fishing vessel presence. As potential effects of vessel traffic on marine mammals is a region-wide concern, BOEM is currently evaluating risk to whales from offshore vessel activities that support wind development. Results of this study are expected to contribute to existing knowledge and to inform decision-making on potential mitigation needs for vessel risks to whales in the US North, Mid-, and South Atlantic WEAs (BOEM 2020b).

To monitor the number of vessels and traffic patterns for analysis and compliance with vessel speed requirements, all vessels associated with the Project will be required to have operational AIS. All vessels will operate in accordance with applicable rules and regulations for maritime operation within US and federal waters. Additionally, the Project will adhere to vessel speed restrictions as appropriate in accordance with BOEM and NOAA requirements.

Vessel activity during O&M will be localized and short-term. Similar to impacts described for the construction phase, in the unlikely event a strike was to occur during Project O&M that resulted in mortality or serious injury impacts to the most vulnerable ESA-listed species (e.g., North Atlantic right whale), the impact could result in population-level effects. Impacts to less vulnerable ESA-listed species and non-ESA listed species from vessel strikes may result in injury or mortality of individuals; however, mortality impacts are expected to be less likely to result in population-level effects.

In addition to the potential for strike, the presence of vessel traffic during O&M can be a stressor to marine mammals but potential behavioral effects are not likely to be discernable from potential effects experienced during existing regional vessel traffic conditions.

Visible Infrastructure

If and how marine mammals perceive or respond to the physical presence of anthropogenic structures in the open ocean is not well understood. It is likely that some marine mammal species may be attracted to the structures for foraging opportunities. Available information suggests the most likely impact of visible infrastructure (i.e., presence of the SRWF) on marine mammals would be the indirect impact of altered prey distributions. While some species may benefit from the expected reef effect, the impact of altered prey distributions will not be universal across potentially affected species. Copepods for example, which are North Atlantic right whale's preferred prey, are planktonic organisms that remain in the water column and are unlikely to be affected.

Structural elements of the SRWF will be present throughout the 25- to 35-year operational life of the Project. Once WTG and OCS-DC foundations have been installed within the seafloor, the presence of the operating SRWF will have converted the existing open water habitat to one with increased hard bottom, making it comparable to an artificial reef-like habitat.

CONSTRUCTION AND OPERATIONS PLAN

Site Characterization and Assessment of Impacts – Biological Resources

The presence of the SRWF foundations, scour protection, and IAC protection will alter the existing habitat, converting sandy bottom habitat to 'hard' habitat, and resulting in a reef effect that encourages colonization by assemblages of both sessile and mobile animals (Bergström et al. 2014; Coates et al. 2014; Wilhelmsson et al. 2006). Studies have shown that artificial structures can create increased habitat heterogeneity that is important for species diversity and density (Langhamer 2012). This change in the visible infrastructure (i.e., presence of the SRWF) would provide a long-term primarily beneficial impact to marine mammals by increasing prey species attracted to Project infrastructure.

The foundations will extend through the water column, which may serve to increase settlement of meroplankton or planktonic larvae on the structures in both the pelagic and benthic zones (Boehlert and Gill 2010). Fish and invertebrate species are also likely to aggregate around the foundations and scour protection, which could provide increased prey availability and structural habitat (Boehlert and Gill 2010; Bonar et al. 2015). This can have a positive side effect creating a sanctuary area for trawled organisms where higher survival of larger fish species is an expected outcome that can extend to outer areas. A review by Langhamer (2012) indicated that the positive reef effect is dependent on the nature and the location of the reef and the characteristics of the native populations.

Numerous surveys at offshore wind farms, oil and gas platforms, and artificial reef sites have documented increased abundance of smaller odontocete and pinniped species attracted to the increase in pelagic fish and benthic prey availability (Arnould et al. 2015; Hammar et al. 2010; Lindeboom et al. 2011; Mikkelsen et al. 2013; Russell et al. 2014). Effects on fish populations may be adverse, beneficial, or mixed, depending on the species and location (Van der Stap et al. 2016) but are expected to be small-scale within the context of the broader region. It is likely the reef effect caused by habitat alteration in the SRWF will provide beneficial foraging opportunities for some marine mammals although the number of species benefiting from this habitat and the significance of the benefit for these species remains uncertain (Bergström et al. 2014). Currently there are no quantitative data on how large whale species (i.e., mysticetes) may be impacted by offshore windfarms (Kraus et al. 2019). Navigation through, or foraging within, the SRWF is not expected to be impeded by the presence of the WTG and OCS–DC foundations. Wakes created by the foundations are not expected to affect pelagic fish, plankton, or benthic species, so marine mammals foraging on these species are unlikely to be adversely affected.

Lighting and Marking

Artificial lighting during O&M will be associated with vessels, the WTGs, and the OCS–DC. Lighting on the WTG foundations and the OCS–DC will be coordinated with the USCG to meet appropriate safety standards and to minimize potential impacts on marine organisms. It is likely that reaction of marine mammals to this artificial light is species- and individual-dependent and may include short-term attraction or avoidance of an area as discussed for construction. Some marine mammal species may also be attracted to the structures for foraging opportunities if fish or plankton are attracted to light sources. Because of the limited area associated with the artificial lighting used on Project vessels, the WTGs, and the OCS–DC, relative to the surrounding unlit regional area, this potential impact is considered either direct or indirect, and short-term.

CONSTRUCTION AND OPERATIONS PLAN

Site Characterization and Assessment of Impacts – Biological Resources

Sunrise Wind Export Cable

With a few exceptions, Project activities are not likely to vary substantially between the SRWEC–OCS and SRWEC–NYS. Similarly, while some marine mammal species show a preference for deeper or shallower waters (see Appendix O), with respect to the mechanism of effect on marine mammals overall, Project activities and potential impacts will be similar between the SRWEC–OCS and SRWEC–NYS, and they are therefore discussed together in the subsections below.

Based on the IPFs identified, during construction and O&M of the SRWEC, marine mammals are expected to experience impacts from seafloor disturbance, sediment suspension and deposition, noise, discharges and releases, trash and debris, vessel traffic, and lighting and marking. During O&M of the SRWEC, marine mammals may additionally experience impacts from EMF and visible infrastructure. The potential impacts associated with each phase of the SRWEC are addressed in the following sections.

Construction

Seafloor Disturbance

Potential impacts associated with seafloor preparation and installation of the SRWEC will be similar to those previously described for installation of the IAC. Installation methods and anticipated maximum disturbance corridors during construction are detailed in Section 3.3.3.4. Construction activities could disturb marine mammals or their prey species in the area of activity. As detailed in Section 4.4.3, mobile fish species are expected to temporarily relocate from the area immediately surrounding seafloor-disturbing activities, and marine mammals foraging in the vicinity may encounter a localized reduction in foraging opportunities. However, because prey would still be available within the overall region surrounding the SRWEC, impacts would be limited to short-term effects on individual marine mammals and not groups or populations.

Sediment Suspension and Deposition

As previously described, installation of the SRWEC will require the excavation of the seafloor within the SRWEC corridor in OCS and NYS waters. These seafloor-disturbing activities are expected to result in localized increases in suspended sediments and an associated increase in turbidity levels. As previously described for the SRWF, increased turbidity can decrease visibility and water quality around the SRWEC.

As further detailed in Appendix H, sediment transport modeling was completed for the installation of the SRWEC in both offshore and nearshore waters. Appendix H concluded that TSS concentrations are predicted to return to ambient levels (<10 mg/L) within 0.4 hours following installation of the modeled SRWEC–OCS cable corridor centerline, and within 0.34 hours following installation of the modeled SRWEC–NYS cable corridor centerline. Furthermore, the TSS plumes were shown to be primarily contained within the lower portion of the water column, approximately 9.8-ft (3.0-m) above the seafloor for both SRWEC–OCS and SRWEC–NYS installation. These limited temporal effects over a relatively small area are not expected to interfere with marine mammal foraging success. Furthermore, after review of sediment transport modeling results, Sections 4.4.2 and 4.4.3 concluded that only short-term, limited impacts to fish and

CONSTRUCTION AND OPERATIONS PLAN

Site Characterization and Assessment of Impacts – Biological Resources

benthic species are expected from suspended sediments; therefore, secondary effects on availability of prey to marine mammals are not expected.

Additionally, HDD (as described in Section 3.3.3.3) will occur within nearshore NYS waters when the SRWEC makes landfall on Fire Island. In general, this will involve drilling horizontally under the seafloor and intertidal zone using a drilling rig that will be located onshore within a designated Landfall Work Area. Drilling fluid (comprised of bentonite, drilling additives, and water) will be pumped to the drilling head to stabilize the created hole. Drilling fluid will then be used to prevent a collapse of the hole and cuttings will be returned to the landfall drill site. Excavation of exit pits will occur offshore within the surveyed corridor and outside of the Fire Island National Seashore boundary, as detailed in Section 3.3.3.3. Sediment transport modeling at the HDD exit pit was also reported in Appendix H. TSS concentrations were predicted to return to ambient levels (<10 mg/L) within 0.3 hours following completion of the excavation, while sediment deposition was predicted to extend a maximum of 79 ft (24 m) from the HDD exit pit, and to cover an area of 0.1 ha of the seafloor. The TSS plumes are predicted to be contained within the lower half of the water column, approximately 7.2 ft (2.2 m) above the seafloor. Considering the results of the sediment transport modeling and existing conditions along the modeled SRWEC cable corridor centerline, suspended sediments due to construction of the Project are expected to be a temporary disturbance to benthic habitats and are not expected to impact marine mammals directly. Similarly, suspended sediments are not likely to have long-term adverse impacts to prey species targeted for consumption by marine mammals along the SRWEC (see Sections 4.4.2 and 4.4.3).

Noise

Noise will be generated during the construction phase of the SRWEC by cable-laying vessels and potential dredging during cable-laying. As the cable-laying operation enters SRWEC–NYS waters, the likelihood of impact decreases with the lower occurrence of marine mammals in nearshore waters, with the possible exception of some dolphins, porpoises, and seals, which may be found closer to shore on a seasonal basis. Pinnipeds that may be present along the SRWEC, particularly the SRWEC–NYS, could also be susceptible to in-air noise disturbance at haulout sites and in-air thresholds have been established by NOAA Fisheries. However, activities at this location are anticipated to produce relatively low levels of in-air noise compared to activities such as impact pile driving underwater (Section 4.4.3).

Impulsive Sound – Geophysical Surveys

Cable installation surveys will be required, including pre- and post-installation surveys, to determine the cable lay-down position and the cable burial depth. Surveys are carried out using a combination of Multibeam Echo Sounder (MBES) or Side-Scan Sonar (SSS) to confirm the mean seafloor and a cable detection system to confirm the target cable burial depth. Site-specific verification has been conducted of all geophysical equipment sound source deployed within the marine portions of the Project Area that operate within the functional hearing range of marine mammals. The survey equipment to be employed will be equivalent to the equipment utilized during the HRG survey campaigns associated with Lease Area OCS-A 0500 conducted in 2016, 2017, 2018, 2019, and 2020 and with Lease Area OCS-A 0487 conducted in 2019 and 2020 (CSA Ocean Sciences Inc. 2020). Hearing injury effects are not expected and any behavioral effects are anticipated to be direct and short-term.

CONSTRUCTION AND OPERATIONS PLAN

Site Characterization and Assessment of Impacts – Biological Resources

Impulsive Sound – MEC/UXO Clearance Surveys

As previously described, MEC/UXO clearance surveys may be used to identify and confirm targets for removal/disposal during seafloor preparation, cable routing, and micrositing of all assets, as detailed in Section 3.3.3.4. These surveys could potentially involve HRG to locate MEC/UXOs, creating impulsive sounds as described above, although clearance through low noise methods is also possible. Avoidance is the preferred approach for MEC/UXO mitigation; however, it is anticipated that there may be instances where confirmed MEC/UXO avoidance is not possible due to layout restrictions, presence of archaeological resources, or other factors that preclude micrositing. In such situations, confirmed MEC/UXO may be removed through in-situ disposal or physical relocation. Selection of a removal method will depend on the location, size, and condition of the confirmed MEC/UXO and will be made in consultation with a MEC/UXO specialist and in coordination with the appropriate agencies.

In-situ disposal will be done with low noise methods like deflagration of the MEC/UXO or cutting the MEC/UXO up to extract the explosive components. The MEC/UXO might also be relocated through a "Lift and Shift" operation, the relocation will be to another suitable location on the seabed within the APE or previous designated disposal areas for either wet storage or disposal through low noise methods as described for in situ disposal. For all MEC/UXO clearance methods, safety measures such as the use of guard vessels, enforcement of safety zones, and others will be identified in consultation with a MEC/UXO specialist and the appropriate agencies and implemented as appropriate.

During Project construction, the likelihood of MEC/UXO encounter is very low. Sunrise Wind will work with BOEM to identify appropriate response actions, which may include developing an emergency response plan, conducting MEC/UXO-specific safety briefings, retaining an on-call MEC/UXO consultant, or other measures (See Appendix G2 for additional detail).

Non-impulsive Sound – Vessel Noise

The dominant underwater noise source from a DP cable-laying vessel is due to cavitation on the propeller blades of the thrusters (Leggat et al. 1981). SRWEC seafloor preparation and installation will occur over a relatively short timeframe (approximately eight months), along a narrow swath of ocean bottom. Noise from Project-related vessel traffic during SRWEC construction is expected to be transient and comparable to existing levels of local and transiting traffic within the region. The underwater noise from Project-related vessel traffic is not expected to exceed existing vessel-related underwater noise levels in the area.

Discharges and Releases

The potential for marine mammal exposure and adverse impacts from routine and non-routine discharges and releases will be similar to those identified for the SRWF. Additionally, HDD at Landfall will use a drilling fluid that consists of bentonite, drilling additives, and water. A barge or jack-up vessel may also be used to assist the drilling process, handle the pipe for pull in, and help transport the drilling fluids and mud for treatment, disposal and/or reuse. To minimize the potential risks for an inadvertent drilling fluid release, an Inadvertent Return Plan will be developed and implemented during construction. Refer to Section 3.3.3.3 for additional details regarding HDD installation and the use of drilling fluids.

CONSTRUCTION AND OPERATIONS PLAN

Site Characterization and Assessment of Impacts – Biological Resources

Trash and Debris

The potential for marine mammal exposure and adverse impacts from routine and non-routine activities resulting in trash and debris will be similar to those identified for the SRWF. Depending on the type of trash or debris, marine mammals could become entangled or ingest foreign materials, causing injury or mortality. However, with proper waste management procedures, the potential for trash or debris to be inadvertently left overboard or introduced into the marine environment is not anticipated.

Vessel Traffic

The potential impacts of vessel traffic on marine mammals would be similar to those discussed above for the SRWF; however, fewer vessels are required for SRWEC installation. Also, as the SRWEC installation activities approach the landfall, fewer large whale species (i.e., those at highest risk of strike) are expected in the area because of the shallower waters and generally less preferred habitat.

Lighting and Marking

Artificial lighting during installation of the SRWEC will be associated with navigational and deck lighting on vessels from dusk to dawn. Artificial lighting on Project-related vessels will be transient relative to the surrounding unlit areas, moving along the cable route during the linear installation of the SRWEC. Similar to impacts described for the SRWF, impacts to marine mammals are considered direct and short-term during SRWEC construction.

Operations and Maintenance

The IPFs resulting in potential impacts on marine mammals in the SRWEC area during the O&M phase are seafloor disturbance, sediment suspension and deposition, noise, EMF, discharges and releases, trash and debris, vessel traffic, and visible infrastructure. As previously discussed, the impacts discussed in this section apply to both the SRWEC–OCS and SRWEC–NYS.

Seafloor Disturbance

Maintenance of the SRWEC involving uncovering and reburial of the cable is considered a non-routine event and is not expected to occur with any regularity. Routine maintenance activities for the SRWEC are not expected to result in seafloor disturbances. As discussed previously, the SRWEC is not expected to significantly alter the existing habitat as it will be buried beneath the seafloor, except for locations where cable protection is deemed necessary by a Cable Burial Risk Assessment. The only potential impact on marine mammals might be the temporary disruption of benthic prey species for marine mammals foraging on or near the seafloor. Given the relatively small area of seafloor that would be disturbed if maintenance of the SRWEC is required, and the availability of prey within the broader region around the SRWEC, impacts on marine mammals from seafloor disturbances during O&M are considered short-term and minimal.

CONSTRUCTION AND OPERATIONS PLAN

Site Characterization and Assessment of Impacts – Biological Resources

Sediment Suspension and Deposition

Increases in sediment suspension and deposition during O&M of the SRWEC will primarily result from vessel anchoring and any maintenance activities that will require exposing the SRWEC. These activities are expected to be non-routine events and are not expected to occur with any regularity. Sediment suspension and deposition impacts resulting in increased turbidity during O&M of the SRWEC are, therefore, anticipated to be similar to those described for the SRWEC construction phase (i.e., temporary and minimal) but less frequent and at a smaller scale.

Noise

Noise may be introduced into the marine environment during O&M of the SRWEC as a result of G&G surveys and support vessels and aircraft.

Impulsive Sound—G&G Surveys

Short-term, localized impacts from HRG surveys during O&M may occur from the use of multi-beam echosounders, side-scan sonars, shallow penetration sub-bottom profilers, medium penetration sub-bottom profilers, and marine magnetometers. The indicative frequency of seafloor surveys during O&M is provided in Section 3.5. Site-specific verification has been conducted of all geophysical equipment sound source deployed within the marine portions of the Project Area that operate within the functional hearing range of marine mammals.

The survey equipment to be employed will be equivalent to the equipment utilized during the HRG survey campaigns associated with Lease Area OCS-A 0500 conducted in 2016, 2017, 2018, 2019, and 2020 and with Lease Area OCS-A 0487 conducted in 2019 and 2020 (CSA Ocean Sciences Inc. 2020).

Non-impulsive Sound – Vessel Noise

Throughout the operational life of the SRWEC, Sunrise Wind expects to use a variety of vessels to support O&M, including SOVs with deployable work boats (daughter craft), CTVs, jack-up vessels, and cable laying vessels. Project vessels will undergo routine maintenance trips between potential ports in New York and Rhode Island and the SRWEC. Impacts from vessel use during O&M would be similar to those described for construction. Marine mammal individuals may experience direct, short-term, reversible behavioral disruptions due to the incremental and transient contribution of O&M vessels.

Non-impulsive Sound – Aircraft

Sunrise Wind expects to use a hoist-equipped helicopter and may also use unmanned aircraft systems to support O&M. The type and number of vessels and helicopters will vary over the operational lifetime of the Project. Impacts from aircraft use during O&M would be similar to those described for construction.

CONSTRUCTION AND OPERATIONS PLAN

Site Characterization and Assessment of Impacts – Biological Resources

Electric and Magnetic Fields

Research suggests that marine species may be more likely to detect and react to magnetic fields from DC cables than the AC cables previously described for the SRWF. Studies of marine mammal strandings data from the United Kingdom and United States found that, in some cases, strandings were correlated with geomagnetic disturbances that occurred one to two days before the stranding. From these results, it was hypothesized that these cetaceans possess a sensitivity to the Earth's geomagnetic field and may at times rely on geomagnetic cues for navigation. However, other studies of strandings show no evidence of geomagnetic navigation.

Appropriate cable protection and/or burial depths are anticipated to reduce potential EMF resulting from cable operation to low levels. As detailed in Appendix J1, the DC magnetic fields at a height of 3.3 ft (1 m) above the SRWEC at peak loading (assessed for all permutations of four geographic directions and four cable configurations) were calculated to change Earth's ambient geomagnetic field by a maximum of ± 129 mG, decreasing to ± 41 mG a horizontal distance of 10 ft (3 m) from the cables, representing a change of less than 10 percent of the ambient geomagnetic field level of approximately 506 mG. Induced DC electric fields in an ocean current of 2 ft/s (60 cm/s) are dominated by the effects of Earth's ambient geomagnetic field and were calculated to be 0.38 mV/m directly above the SRWEC, decreasing to 0.033 mV/m at a distance of ± 10 -ft (3-m). Because marine mammals likely to occur within the SRWEC would be transiting and foraging and would not spend significant time on the seafloor in proximity to the proposed cables, direct impacts to marine mammals from DC EMF is considered unlikely. Electric and magnetic fields are not generally considered to directly affect marine mammals. Any impacts such as change in swimming direction or altered migration routes are not anticipated to result in adverse effects to individual or population health. Indirect effects on marine mammals from alterations in prey due to EMF are also highly unlikely. As detailed in Section 4.4.3, it is not expected that finfish will be measurably affected by EMF from the SRWEC.

Discharges and Releases

Impacts to marine mammals from marine discharges and releases during O&M are expected to be similar to, but of lesser likelihood than during construction as there will be fewer Project-related marine vessels during this phase, and regulatory requirements and preventative measures will still apply.

Trash and Debris

Impacts to marine mammals from disposal of trash and debris during O&M are expected to be similar to, but of lesser likelihood than during, construction as there will be fewer Project-related marine vessels during this phase, and regulatory requirements and preventative measures will still apply.

Vessel Traffic

The potential impacts of vessel strikes on marine mammals will be similar, although likely less, than those identified for O&M of the SRWF, and environmental protection measures will be implemented to reduce the risk of vessel strikes.

CONSTRUCTION AND OPERATIONS PLAN

Site Characterization and Assessment of Impacts – Biological Resources

Visible Infrastructure

Cable protection measures such as concrete mattresses may be placed in select areas along the SRWEC, providing sporadic hard bottom habitat along the SRWEC corridor. Cable protection measures would not extend into the water column and would be comparable to existing areas where boulders or other hard bottom habitat are present. Species composition along the cable route is, therefore, not expected to change substantially following construction. The introduction of hard bottom habitat along the corridor may have a beneficial long-term impact on benthic species/marine mammal prey and impacts are likely to be similar or less than those previously described for O&M of the SRWF.

Onshore Facilities

Construction

Land Disturbance and Noise

After landfall on Fire Island, the Onshore Transmission Cable will cross the ICW via an HDD to a paved parking lot within the Smith Point Marina along East Concourse Drive. During construction of the Onshore Facilities, marine mammals in the ICW may be able to detect in-air noise associated with HDD installation activities, as well as from barge traffic and activities associated with installation of the temporary floating pier. Seals hauled out on land or in the ICW in the immediate vicinity may experience direct, short-term impacts from land disturbance and noise; however, these effects are expected to be limited to temporary behavioral disturbance (e.g., entering the water). As previously described, HDD will occur onshore within the designated Landfall and ICW Work Areas. Prior to Landfall HDD activities, pipeline stringing will need to occur, which will consist of laying the pipeline on the beach, adjacent to the water. As of now, the Landfall HDD activity is expected to occur from October through March, during which time pipeline will be sitting on the beach. This activity, and the noise it produces, may also disturb or displace hauled-out seals; however, the disturbance/displacement will be temporary, with beach habitat returning to pre-existing conditions once construction is complete. Furthermore, the nearest AMCS-documented haulout site is located approximately 6 to 7 mi (10 to 11 km) from where HDD activities will occur.

Discharges and Releases

Although no impacts from discharges and releases are anticipated, spills or accidental releases of fuels, lubricants, or hydraulic fluids could occur during use of trenchless installation and duct bank installation methods, and installation of the Onshore Transmission Cable. An SPCC Plan will be developed and any discharges or releases will be governed by New York State regulations. Additionally, where HDD is utilized, an Inadvertent Return Plan will be prepared and implemented to minimize the potential risks associated with release of drilling fluids, and to avoid and minimize any potential impacts to the ICW (and thereby marine mammals potentially utilizing the area). Any unanticipated discharges or releases within the Onshore Facilities during construction are expected to result in minimal, temporary impacts; activities are heavily regulated, and discharges and releases are considered accidental events that are unlikely to occur.

CONSTRUCTION AND OPERATIONS PLAN

Site Characterization and Assessment of Impacts – Biological Resources

Trash and Debris

Good housekeeping practices will be implemented to minimize trash and debris in onshore work areas. These practices will include orderly storage of tools, equipment, and materials, as well as proper waste collection, storage, and disposal to keep work areas clean and minimize potential environmental impacts. All trash and debris returned to shore from offshore vessels will be properly disposed of or recycled at licensed waste management and/or recycling facilities. Disposal of any solid waste or debris in the water will be prohibited. With proper waste management procedures, the potential for trash or debris to be inadvertently introduced onto an onshore area is unlikely.

Operations and Maintenance

The IPFs resulting in potential impacts on marine mammals in the Onshore Facilities (the ICW) during the O&M phase are EMF, discharges and releases, and trash and debris.

Electric and Magnetic Fields

The ICW is part of a partially enclosed waterbody with less natural flushing or tidal activity as compared with the open ocean and nearshore waters previously described. Additionally, where the Onshore Transmission Cable will cross, the water depths are less than 10 ft (3 m; NOAA n.d.). As with nearshore waters, marine mammals are most likely to encounter EMF effects from the subsea cable if feeding on benthic organisms or resting on the seafloor above the cable. However, only very low or no EMF levels are expected to be detected at the ICW crossing, depending on exact burial depth at time of construction. Additionally, marine mammals are more likely to be utilizing the nearby larger portions of Great South Bay as opposed to the more trafficked and narrowed crossing of the Smith Point Bridge where the subsea cables will be installed.

Discharges and Releases

The OnCS–DC will require various oils, fuels, and lubricants to support its operation, and SF₆ gas will also be used for electrical insulating purposes. As described above in the construction section, accidental discharges, releases, and disposal could indirectly cause habitat degradation, but risks will be avoided through implementation of the measures described in the SPCC.

Trash and Debris

Solid waste and other debris will be generated predominantly during Project construction activities but may also occur during O&M of the Onshore Facilities. With the implementation of proper waste management procedures, and adherence to regulations, the potential for trash or debris to be inadvertently introduced onto an onshore area is unlikely.

CONSTRUCTION AND OPERATIONS PLAN

Site Characterization and Assessment of Impacts – Biological Resources

4.4.4.3 Proposed Environmental Protection Measures

A protected species mitigation and monitoring plan will be developed, which will incorporate findings from the underwater acoustic assessment; supplement existing data gaps; allow for an evaluation of changes caused by offshore infrastructure within the context of larger regional shifts in species distributions; and describe the avoidance, minimization, mitigation, and monitoring measures and approaches taken by Sunrise Wind. Long-term regional monitoring efforts will also be discussed in the plan. Sunrise Wind will work further with BOEM and NOAA Fisheries to refine an adaptive mitigation and monitoring approach that optimizes flexibility, while appropriately mitigating potential impacts to marine mammals, including the following proposed environmental protection measures:

- Sunrise Wind will comply with the current National Oceanic and Atmospheric Administration (NOAA) Fisheries speed restrictions at the time of Project activities.
- Sunrise Wind will require operational automatic identification system (AIS) on all vessels associated with the construction, O&M, and decommissioning of the Project, pursuant to USCG and AIS carriage requirements. AIS will be used to monitor the number of vessels and traffic patterns for analysis and compliance with vessel speed requirements.
- Sunrise Wind will adhere to vessel strike avoidance measures as required by BOEM and NOAA Fisheries.
- To the extent feasible, the SRWEC and IAC will typically target a burial depth of 3 to 7 ft (1 to 2 m). The target burial depth will be determined based on an assessment of seabed conditions, seabed mobility, the risk of interaction with external hazards such as fishing gear and vessel anchors, and a site-specific Cable Burial Risk Assessment.
- For all munitions and explosives of concern / unexploded ordnance (MEC/UXO) clearance methods, safety measures such as the use of guard vessels, enforcement of safety zones, and others will be identified in consultation with a MEC/UXO specialist and the appropriate agencies and implemented as appropriate. Residual risk management actions will be implemented, including developing an emergency response plan, conducting MEC/UXO-specific safety briefings, and retaining an on-call MEC/UXO consultant.
- Plow cables/umbilicals will be under constant tension, and in this taut condition, are not expected to represent an entanglement risk.
- Sunrise Wind will require all construction and O&M vessels to comply with applicable International Convention for the Prevention of Pollution from Ships (IMO MARPOL), federal (USCG and EPA), and state regulations and standards for the management, treatment, discharge, and disposal of onboard solid and liquid wastes and the prevention and control of spills and discharges.
- Sunrise Wind will provide training for personnel onboard Project vessels, including PSO monitoring and reporting procedures, to emphasize individual responsibility for marine mammal awareness and protection.

CONSTRUCTION AND OPERATIONS PLAN

Site Characterization and Assessment of Impacts – Biological Resources

- All crew supporting the Project will undergo marine debris awareness training, and such training will include use of the data and educational resources available through the NOAA Fisheries Marine Debris Program.
- Sunrise Wind will advise all construction and O&M vessels to comply with USCG and EPA regulations that require operators to develop waste management plans, post informational placards, manifest trash sent to shore, and use special precautions such as covering outside trash bins to prevent accidental loss of solid materials.
- Sunrise Wind completed a comprehensive underwater acoustic assessment to include modeling in support of evaluation of potential impacts due to noise generated during construction of the Project. The assessment followed NOAA Fisheries' 2018 revised *Technical Guidance for Assessing the Effects of Anthropogenic Sound on Marine Mammal Hearing* (NOAA Construction and Operations Plan Fisheries 2018a). Potential zones of influence described in this assessment will be reflected in the proposed mitigation measures in the mitigation and monitoring plan.
- Sunrise Wind will continue to support external initiatives to further mitigate marine traffic impacts and currently is a supporter of the Whale Alert system.
- Sunrise Wind will participate in a developer co-funded initiative to support continuation of New England Aquarium Right Whale Aerial Surveys in 2020/21.
- Additionally, the Project will implement the following mitigation measures, pursuant to ongoing dialogue with BOEM and NOAA Fisheries. Each of these methods and tools has been successfully applied by Orsted, Sunrise Wind, and/or its affiliates in support of geophysical surveys and/or the construction and operation of offshore wind projects across the globe. A protected species mitigation and monitoring plan will describe these measures and will be included within the Letter of Authorization (LOA):
 - Exclusion and monitoring zones
 - Ramp-up/soft-start procedures
 - Shutdown procedures (if technically feasible)
 - Qualified and NOAA Fisheries-approved protected species observers (PSOs)
 - Noise attenuation technologies
 - Passive Acoustic Monitoring systems (fixed and mobile)
 - Reduced visibility monitoring tools/technologies (e.g., night vision, infrared and/or thermal cameras)
 - Adaptive vessel speed reductions
 - Utilization of software to share visual and acoustic detection data between platforms in real time.

CONSTRUCTION AND OPERATIONS PLAN

Site Characterization and Assessment of Impacts – Biological Resources

4.4.5 Sea Turtles

This section describes the affected environment and potential effects from the construction and O&M of the Project as they relate to sea turtles. The description of the affected environment and assessment of potential impacts to sea turtles were developed by reviewing the most recent literature and studies available that focus on renewable energy sites in the Mid-Atlantic and New England regions, including the MA WEA, RI-MA WEA, Rhode Island OSAMP area, the New York Bight, and the New York OPA (Kenney and Vigness-Raposa 2010; Kraus et al. 2016; Normandeau and APEM 2019; NYSDEC 2017, 2020a; NYSERDA 2017; Palka 2010, 2011, 2012, 2013, 2014, 2015; Palka et al. 2017; Tetra Tech and LGL 2020). Additional data sources utilized include data from the NOAA Fisheries ESA Section 7 mapper tool (NOAA Fisheries 2020), the Summary Report of the New York Bight Sea Turtle Workshop held in 2018 (Bonacci-Sullivan 2018); Kraus et al. (2016), AMAPPS Surveys (NOAA Fisheries 2017), NOAA Threatened and Endangered Species Directory (NOAA Fisheries n.d.[a]), the most recent State of the World's Sea Turtles (SWOT 2020), Kenney and Vigness-Raposa (2010), and CETAP (1982).

Where available, the review also draws from multiple years of PSO sightings data derived from different contractor datasets gathered during Sunrise Wind geophysical and geotechnical surveys undertaken across the SRWF. Sunrise Wind recognizes that PSO sightings data are opportunistic; however, they are included herein to provide supplemental sightings data for sea turtle species and to illustrate inter-annual variation in species occurrence in the SRWF. Sightings data, if used with discretion, can be valuable (Baker et al. 2013; BOEM 2018) from a practical standpoint in that they inform which species may be present during operations. Previous BOEM reports have utilized PSO data for such purposes (Barkaszi and Kelly 2018). Relevant PSO data are provided in Appendix O and are summarized within this analysis.

Available literature and published information from the collaborative work of the USFWS and the Greater Atlantic Region Sea Turtle Program managed by NOAA Fisheries have been used to characterize expected distributions and behavior, and sea turtle geospatial sighting information was retrieved from OBIS sighting data from 1989 to 2016 (Curtice et al. 2019; Halpin et al. 2009; Roberts et al. 2018, 2016a, b). Finally, strandings data have been summarized within this analysis, obtained from the RI DEM (2011) and NOAA's Southeast Fisheries Science Center (SEFSC)'s Sea Turtle Stranding and Salvage Network Reports (NOAA SEFSC 2020). The Salvage Network Reports for the entire US are managed by the SEFSC, and data for the last five years in New York waters are considered herein. Further details from all these sources are discussed in Appendix O.

Specific requirements for submittal of sea turtle information within this COP are provided in BOEM's *Guidelines for Providing Information on Marine Mammals and Sea Turtles for Renewable Energy Development on the Atlantic Outer Continental Shelf* pursuant to 30 CFR § 585 Subpart F (BOEM 2019a). In support of the COP, sea turtle resources must be assessed to comply with BOEM's site characterization requirements in 30 CFR § 585.626(3). BOEM's *Marine Mammal and Sea Turtle Guidelines* (2019a) include specific assessment requirements, such as determining spatial and temporal distribution and abundance of sea turtles, establishing baseline ambient sound levels, and characterization of habitat use by sea turtles. The following assessment considers these guidelines.

CONSTRUCTION AND OPERATIONS PLAN

Site Characterization and Assessment of Impacts – Biological Resources

A description of the sea turtles in the SRWF, along the SRWEC, and in the ICW is provided below, followed by an evaluation of potential Project-related impacts. For the purposes of the sea turtle analysis, discussion of Great South Bay was also included in the below analysis. Sightings and potentially suitable habitat data from Great South Bay were used as representative data for the ICW where applicable as the waterbody is hydrologically connected and immediately adjacent. More detailed information concerning sea turtle life history, presence and distribution within the SRWF, SRWEC, and ICW, along with potential Project-related impacts, and a more detailed evaluation of acoustic impacts are presented in Appendix O. Appendix I1 presents underwater acoustic and animal movement modeling, results of which are summarized in this section and addressed further in Appendix O. Appendix J1 presents the offshore EMF assessment.

4.4.5.1 Affected Environment

Regional Overview

There are four species of sea turtle commonly found throughout the western North Atlantic Ocean. These may occur in the marine portions of the Project Area and are, therefore, considered potentially affected species. These are the green sea turtle (*Chelonia mydas*), Kemp's ridley sea turtle (*Lepidochelys kempii*), loggerhead sea turtle (*Caretta caretta*), and leatherback sea turtle (*Dermochelys coriacea*). These species are federally listed as Endangered or Threatened under the ESA and by the states of New York, Massachusetts, and Rhode Island (MA Natural Heritage and Endangered Species Program [NHESP] 2020; NYSDEC n.d.; RI DEM 2020), as detailed in Table 4.4.5-1. Also included in Table 4.4.5-1 are current estimated population densities and predicted relative occurrence of each species within the Project Area. Additional details on each species and the history and likelihood of presence in the Project Area can be found in Appendix O.

The relative occurrence noted in Table 4.4.5-1 is based on five qualitative categories, which are defined as follows:

- **Common.** Species occurs consistently in moderate to large numbers.
- **Regular.** Species occurs in low to moderate numbers on a regular basis or seasonally.
- **Uncommon.** Species occurs in low numbers or on an irregular basis.
- **Rare.** Species records are available for some years but are limited.
- **Not expected.** Species' range includes the Project Area, but due to habitat preferences and distribution information, species is not expected to occur in the Project Area although records may exist for adjacent waters.

CONSTRUCTION AND OPERATIONS PLAN

Site Characterization and Assessment of Impacts – Biological Resources

A fifth species, the hawksbill sea turtle (*Eretmochelys imbricata*), may occur infrequently within the region but is found predominantly in tropical waters associated with coral reef habitats and is considered extremely rare (NOAA GARFO 2020a). Kraus et al. (2016) documented no sightings over a four-year survey period, and AMAPPS (NOAA Fisheries 2017) documented one hawksbill turtle sighting out of 992 unique sea turtle sightings in 2017 with no other sightings in any of seven other annual surveys in the SRWF completed since 2010. The survey by CETAP (1982) has no mention of hawksbill species sightings. One hawksbill turtle stranding was recorded in Massachusetts in 1968 (Kenney and Vigness-Raposa 2010), and one hawksbill turtle sighting was noted from the Bay State Wind site assessment survey data in SRWF waters from two years of survey data. The potential for hawksbill occurrence is very low; therefore, no impacts are expected, and this species is not considered further in the following analysis.

This page intentionally left blank

CONSTRUCTION AND OPERATIONS PLAN

Site Characterization and Assessment of Impacts – Biological Resources

Table 4.4.5-1 Listed Species with Potential Occurrence in the Regional Waters of the Western North Atlantic OCS and Project Area

Species	Current Listing Status ^b	Estimated Population	Seasonal Density (no./100 km ²) ^a				Relative Occurrence in the SRWF	Relative Occurrence in the SRWEC OCS Station	Relative Occurrence in the SRWEC NYS	Relative Occurrence in the Onshore Facilities
			Winter	Spring	Summer	Fall				
Leatherback Sea Turtle (<i>Dermochelys coriacea</i>)	ESA Endangered NY State Endangered RI State Endangered MA State Endangered	<ul style="list-style-type: none"> Northwest Atlantic DPS estimate of 31,380 adult males and females (TEWG 2007; Epperly 2017; USFWS 2013) Between 34,000 and 36,000 estimated nesting females in the US (Sea Turtle Conservancy 2020a) Global total average estimate of 426,000 (SWOT 2020) 	0.0003	0.000	0.0003	0.0003	Common	Common	Common	Not Expected
Loggerhead Sea Turtle (<i>Caretta caretta</i>)	ESA Threatened NY State Threatened RI State Endangered MA State Threatened	<ul style="list-style-type: none"> Western North Atlantic adult female population estimate of 38,334 (Richards et al. 2011) Between 40,000 and 50,000 estimated nesting females in the US (Sea Turtle Conservancy 2020b) Global total average estimate of 314,000 (SWOT 2020) 	0.001	0.002	0.001	0.001	Common	Common	Common	Regular
Kemp's Ridley Sea Turtle (<i>Lepidochelys kempii</i>)	ESA Endangered NY State Endangered RI State Endangered MA State Endangered	<ul style="list-style-type: none"> Between 7,000 and 9,000 estimated nesting females in the US (Sea Turtle Conservancy 2020c) Global total average estimate of 21,000 (SWOT 2020) 	0.0007	0.0007	0.00007	0.0007	Uncommon	Uncommon	Common	Regular
Green Sea Turtle (<i>Chelonia mydas</i>)	ESA Threatened NY State Threatened RI State Endangered MA State Threatened	<ul style="list-style-type: none"> Northwest Atlantic DPS nester abundance distribution estimates 167,424 total abundance (Seminoff et al. 2015) Between 85,000 and 90,000 estimated nesting females in the US (Sea Turtle Conservancy 2020d) Global total average estimate of 1,002,000 (SWOT 2020) 	No Data				Uncommon	Not Expected/Rare	Rare	Regular

Key: DPS = distinct population segment

NOTES:

a/ Sea turtle density provided by OBIS-Seamap (Curtice et al. 2019; Halpin et al. 2009; Roberts et al. 2018, 2016a, b).

b/ Listing status as stated in NOAA Fisheries n.d.[a], MA NHESP 2020; NYSDEC 2020a; RI DEM 2011;

This page intentionally left blank

CONSTRUCTION AND OPERATIONS PLAN

Site Characterization and Assessment of Impacts – Biological Resources

USFWS and NOAA Fisheries share the responsibility for sea turtle recovery under the authority of the ESA. USFWS has jurisdiction over sea turtles when in terrestrial habitat, while NOAA Fisheries has jurisdiction over sea turtles in oceanic habitat. As outlined in Section 1.0, the ESA (16 USC § 1531) prohibits the unauthorized taking, possession, sale, and transport of listed species. Under Section 7 of the ESA, federal agencies must consult with USFWS and NOAA Fisheries to ensure that any action authorized, funded, or carried out by that agency is not likely to jeopardize the continued existence of any endangered or threatened species or result in the destruction or adverse modification of identified critical habitat.

The Northeast coast, including marine components of the SRWF, contains a variety of habitats suitable for sea turtles. These regional waters include deeper waters of the Atlantic Ocean, Rhode Island Sound, Block Island Sound, and shallow enclosed waters of the ICW and Great South Bay. In the offshore and coastal waters of New York, all four species of sea turtles discussed within this analysis have been recently documented (predominantly in the summer and fall) during the NYSERDA Digital Aerial Baseline Surveys (Normandeau 2016a, b; 2017a, b, c; 2018) and during the 2017-2020 NYSDEC Whale Monitoring Program aerial surveys (Tetra Tech and LGL 2020). Furthermore, OBIS sighting data from 1989 to 2016 are the result of multiple surveys and published studies that were compiled in literature reviews (Curtice et al. 2019; Halpin et al. 2009; Roberts et al. 2018, 2016a, b). These data, provided in Figure 4.4.5-1, shows leatherback sea turtles and loggerhead sea turtles residing in mostly offshore waters with occasional occurrences nearshore. Kemp's ridley sea turtles were shown to occur most commonly in nearshore waters with the occasional appearances offshore. Green sea turtles were not documented as regularly within this dataset, but the few occurrences of the species that were reported occurred just outside Block Island Channel.

This page intentionally left blank

V:\1956\active_Task Owner and other Non-BC1956_Jobs\2028113199\03_data\gis_cad\gis\MDs\COP\2028113199_4.4.5-1_SeaTurtles.mxd Revised: 2021-05-07 By: graepentier

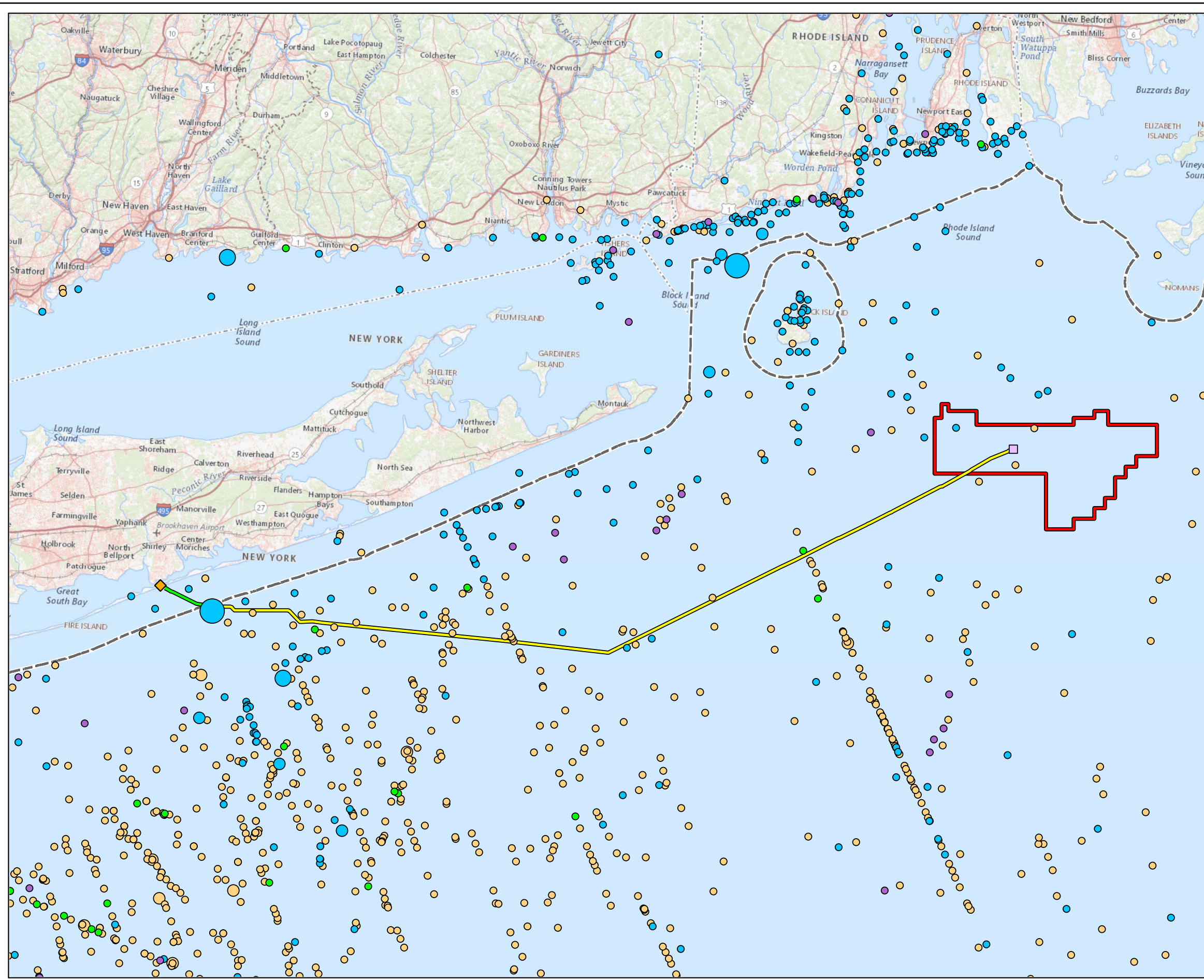

Figure 4.4.5-1
OBIS-SEAMAP Sea Turtle Sightings Data
1963 – 2019

Sunrise Wind | Powered by **Ørsted & Eversource**

Legend

- Sunrise Wind Farm (SRWF)
- Offshore Converter Station (OCS-DC)
- ◆ SRWEC Landfall Location
- Sunrise Wind Export Cable (SRWEC-NYS)
- Sunrise Wind Export Cable (SRWEC-OCS)
- 3-nm State Waters Boundary

Sea Turtle Sighting Counts

Green sea turtle	Leatherback sea turtle
● 1	● 1
Kemp's ridley sea turtle	● 2
● 1	● 3
Loggerhead sea turtle	● 5
● 1	
● 2	

Sources

1. Sea turtle data extracted on 7/14/2020 from the Ocean Biodiversity Information System Spatial Ecological Analysis of Megavertebrate (OBIS-SEAMAP).
2. Base map: USGS The National Map

Date	12/18/2020 Revised: 6/1/2021
Project Number	2028113199
Prepared By	GC
Reviewed By	LJ

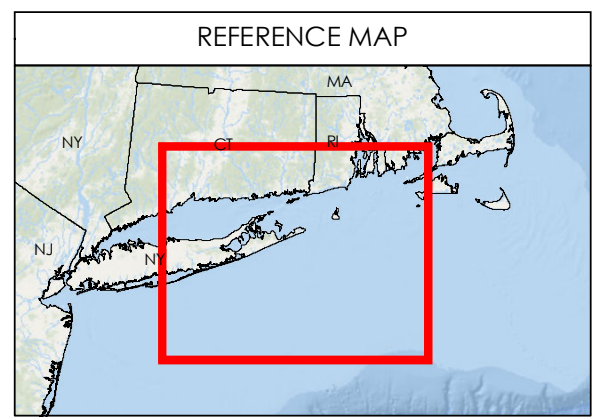
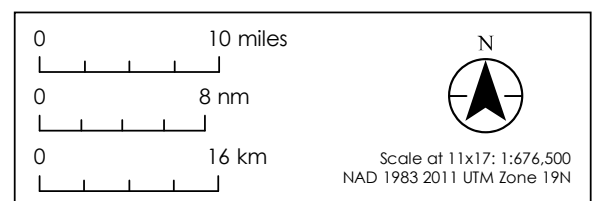

This page intentionally left blank

CONSTRUCTION AND OPERATIONS PLAN

Site Characterization and Assessment of Impacts – Biological Resources

Project-specific PSO data from Sunrise Wind Geotechnical Surveys conducted November 2019 through March 2020 (Smultea 2020) detected no sea turtles within the survey area, which included the SRWF. PSO data from the Bay State Wind Geotechnical Survey conducted April through June 2019 (Smultea 2019) showed two sea turtle sightings outside the SRWF: one green sea turtle in nearshore waters off of western Long Island and one unidentified turtle within OCS waters offshore of eastern Long Island (Smultea 2019).

Sea turtle strandings have been documented on Long Island during the winter months although surveys have not recorded sea turtle observations in the winter (Kraus et al. 2016). In Rhode Island, from 1990 to 2011, a total of 71 sea turtles (green [2], Kemp's ridley [7], leatherback [11], loggerhead [48], and unknown [3]) were documented as stranded in Rhode Island Waters (RI DEM 2011). Additionally, NOAA Fisheries maintains online weekly reports dating back to 1998 on stranded sea turtles within the US. The Sea Turtle Stranding and Salvage Network Reports contain all reported New York State sea turtle strandings, which are defined as "a sea turtle that is either found dead or is alive but is unable to go about its normal behavior due to any injury, illness, or other problem" and is "found washed ashore or floating in the water" (NOAA SEFSC 2020). Details of strandings data reported by the NOAA SEFSC from a five-year period between 2015 and 2019 in inshore and offshore New York waters are presented in Appendix O.

There is no designated critical habitat for sea turtles in the Project Area; however, while not formally identified as critical habitat, research in Long Island Sound has suggested that this area could potentially provide critical coastal developmental habitat for immature Kemp's ridley turtles during their early turtle life stages (two to five years) (Morreale et al. 1992; NYSDEC n.d.).

There are also no nesting habitats for sea turtles in the Project Area. Sea turtles typically nest in tropical, subtropical, and warm-temperate beaches, shoreward of the mean high tide line (Davenport 1997). In the southeastern US, sea turtle nesting typically only stretches as far north as North Carolina; however, there was a recent incidence of nesting by a Kemp's ridley sea turtle in New York (AM New York 2018). During the New York Bight Sea Turtle Workshop held in 2018, it was suggested that a nesting response plan is needed in the unlikely event that a sea turtle nest is discovered in New York, and work on that plan is expected to occur after the 2019/2020 cold stun season (Bonacci-Sullivan 2018). However, as there are no sea turtle nesting records north of New York, and the one instance of nesting in New York was an extremely rare occurrence, no further discussion of nesting is included within this analysis.

As the climate continues to change, sea turtle habitat, nest site selection, and reproductive success may be affected. Nearshore habitats and sea grasses could be adversely affected by increased water temperatures, changes in salinities, and other climate-related factors which could make habitats potentially unsuitable for sea turtles or their prey (Fuentes and Abbs 2010; Newson et al. 2009; Witt et al. 2010). Similarly, rising temperatures could affect the amount of suitable nesting habitat available, and cause clutch mortality. Marine turtle eggs are sensitive to temperatures during the incubation period with offspring sex determined by temperature (Hawkes et al. 2009; Janzen 1994). Climate change could therefore impact sex ratios causing strain on sea turtle reproductive success. Sea turtles could also experience changes in prey foraging success from climate change effects. Oceanographic current patterns are an important factor on sea turtle prey availability (jellyfish, salps, and epipelagic prey); therefore, sea turtles may alter daily movements and migrations based on available forage.

CONSTRUCTION AND OPERATIONS PLAN

Site Characterization and Assessment of Impacts – Biological Resources

Descriptions in the following sections are intended to provide a general overview of the anticipated distribution of potentially affected species of sea turtles throughout the offshore waters (SRWF and SRWEC–OCS), coastal waters (SRWEC–NYS), and Onshore Facilities (including discussion of potential for occurrence in the ICW).

Sunrise Wind Farm and Sunrise Wind Export Cable–OCS

In offshore waters of the Project Area, the leatherback and loggerhead sea turtles are the most likely of the four species included in Table 4.4.5-1 to be found in proximity to the SRWF and SRWEC–OCS and are expected to be commonly occurring particularly in the summer and fall seasons. Thirty-seven leatherback sea turtle individuals and 16 loggerhead individuals were sighted within the New York Bight during the three years (2017-2020) of aerial surveys conducted by Tetra Tech and LGL Ecological Research Associates for the NYSDEC Whale Monitoring Program (Tetra Tech and LGL 2020). These turtles were in offshore, federal waters in the vicinity of the SRWF and SRWEC–OCS. Leatherback sea turtles were the most frequently sighted turtle species in the RI-MA and MA WEAs and were predominantly observed from summer through fall (Kraus et al. 2016). They were rarely detected around the SRWF and SRWEC–OCS in the spring and not detected at all during the winter (Kraus et al. 2016; Normandeau 2016a, b; 2017a, b, c; 2018). The greatest number of leatherback sea turtle detections in the RI-MA and MA WEAs occurred in August, with a high concentration of sightings south of Nantucket (Kraus et al. 2016) in the fall. The highest anticipated abundances of leatherback sea turtles can, therefore, be expected in the offshore waters of the SRWF and SRWEC–OCS in the summer and fall (Kraus et al. 2016). Loggerhead sea turtles forage off the northeastern US and migrate south in the fall as temperatures drop. As previously discussed, loggerhead sea turtles frequently occur in waters off the coast of New York, Massachusetts, and Rhode Island. AMAPPS surveys reported loggerhead sea turtles as the most commonly sighted sea turtles in shelf waters from New Jersey to Nova Scotia, Canada (Palka et al. 2017). Kraus et al. (2016) reported that loggerhead sea turtle occurrence in the RI-MA and MA WEAs was highest during the summer and fall. During the NYSERDA Digital Aerial Baseline Surveys (NYSERDA 2017), sightings were dispersed across the continental shelf offshore of Long Island, with the greatest number of detections during summer 2017 surveys. Fewer individuals were observed during fall surveys, and no loggerhead sea turtles were detected during winter surveys (Normandeau and APEM 2019). Reported sightings show a wide distribution seasonally throughout the RI-MA and MA WEAs (Kraus et al. 2016; Palka et al. 2017) and suggest that loggerhead sea turtles are most likely to be encountered within the SRWF and SRWEC–OCS during the summer and fall. There are a limited number of reported, confirmed sightings of green sea turtles in the general vicinity of the offshore components of the Project Area, which is likely a result of both effort, difficulty of locating small species in large areas of open water, and their actual distribution and life history characteristics. One confirmed green sea turtle sighting was reported in March 2005, south of Long Island between the 131- and 164-ft (40- and 50-m) isobaths (Kenney and Vigness-Raposa 2010). Another confirmed green sea turtle sighting occurred during summer 2016 surveys off Long Island (Normandeau and APEM 2019). Due to the few reported observations of green sea turtles in this area, and their preferred habitat of high-energy oceanic beaches, pelagic convergence zones, and shallow protected waters (NOAA Fisheries and USFWS 1991), green sea turtles are not expected to occur within the SRWF. However, a few green sea turtles may have a rare presence in the shallower water portions of the SRWEC–NYS during the summer.

CONSTRUCTION AND OPERATIONS PLAN

Site Characterization and Assessment of Impacts – Biological Resources

Adult Kemp's ridley sea turtles, like green sea turtles, spend limited time in offshore pelagic waters although those that occur in southern New England can be seen in Long Island Sound, along the Rhode Island coastline, and in Cape Cod Bay, MA (CETAP 1982; Waring et al. 2012). They are generally more common in the New York Bight region and along the Long Island coastline. One individual was sighted within federal waters of the New York Bight from 2017-2020 (Tetra Tech and LGL 2020). There are limited visual sighting records for Kemp's ridley turtles in the SRWF or waters along the SRWEC–OCS, although this may be at least in part attributable to their small size, which makes detections during aerial surveys difficult (Normandeau and APEM 2019). Kenney and Vigness-Raposa (2010) reported 14 observations of Kemp's ridley sea turtles offshore of Rhode Island around Block Island in the summer and fall between 1979 and 2002. During the summer of 2016, 18 Kemp's ridley turtles were detected in the New York OPA, and one Kemp's ridley turtle was detected in the fall 2016 surveys (Normandeau and APEM 2019). The Kemp's ridley sea turtle could, therefore, be seasonally present in low densities in the offshore waters of the SRWF, but their presence is expected to be uncommon; they may be somewhat more likely to be present within the more nearshore section of the SRWEC–OCS waters as they transition into state waters and the SRWEC–NYS.

Sunrise Wind Export Cables–NYS

Of the ESA-listed species with moderate or higher likelihood of occurrence within the Project Area (Table 4.4.5-1), all four may be found within nearshore New York waters. Sea turtles are likely to be present in nearshore waters most often during the summer and fall seasons. As water temperatures begin to rise in late spring and early summer, the coastal waters of New York become more suitable for sea turtles (NYSDEC n.d.). Sea turtles remain local to New York from approximately May through November and prefer the warmer waters in coastal bays and the Long Island Sound. By the end of November, they begin their migration south to warmer nesting waters (NYSDEC n.d.). Leatherback, loggerhead, green, and Kemp's ridley sea turtles may all be present within the nearshore areas, where the SRWEC–NYS traverses NYS waters and makes landfall.

During NYSDEC Whale Monitoring Program aerial surveys, a total of 474 incidental sea turtle sightings (an estimated 557 individuals) were recorded (Tetra Tech and LGL 2020). A total of 50 sea turtle groups (54 individuals) were identified to species, including 16 loggerhead sea turtles, 37 leatherback sea turtles, and one Kemp's ridley sea turtle (Tetra Tech and LGL 2020). The remaining sea turtle sightings (424 sightings, 503 individuals) were not identified to species (Tetra Tech and LGL 2020).

In New York waters, leatherback turtles are often seen on the south shore of Long Island, in the New York Bight region, and within the Long Island Sound (CETAP 1982; NYSDEC n.d.). Boaters fishing within 10 mi (16 km) of the south shore of Long Island frequently report leatherback sightings (NOAA Fisheries and USFWS 1992). During the fall of 2016, 28 leatherbacks were detected in the New York OPA (Normandeau and APEM 2019). Leatherback occurrence within the SRWEC–NYS is likely to be common.

CONSTRUCTION AND OPERATIONS PLAN

Site Characterization and Assessment of Impacts – Biological Resources

Loggerhead sea turtles are the most frequently seen sea turtle in New York waters (NYSDEC n.d.; Normandeau and APEM 2019), although they inhabit different regions during different parts of their lives. Two of the 16 previously mentioned loggerhead sea turtles were documented in nearshore NYS waters during 2017-2020 aerial surveys (Tetra Tech and LGL 2020). Juveniles are frequently found in nearshore bays and Long Island Sound, while other age groups, including adults, are found up to 40 mi (64 km) off the southern Long Island coast (CETAP 1982; NYSDEC n.d.). As juveniles transition to adults, habitat preferences shift to more shallow water with open ocean access (NYSDEC n.d.). Loggerheads are most commonly seen in June and then decrease by October (Shoop and Kenney 1992). Loggerhead turtle occurrence within the SRWEC–NYS route is expected to be common.

During the warmer months of the year, juvenile and occasionally adult green sea turtles have been sighted in sea grass beds off the eastern side of Long Island (NOAA Fisheries and USFWS 1991). One sighting was reported in the New York OPA in the summer 2016 NYSERDA surveys (Normandeau and APEM 2019). Although green sea turtles have been documented in New York waters, based on the infrequency of records, the wide distribution of these reports, and the higher likelihood of green sea turtles in New York waters concentrating around seagrass beds, green sea turtles are expected to have a rare occurrence along the modeled SRWEC–NYS cable corridor centerline.

Beginning in July, Kemp's ridley sea turtles inhabit the Long Island Sound area, and in October, the turtles begin to migrate out of the estuaries and back into pelagic environments. The Kemp's ridley turtle has a documented presence off the coast of Long Island, NY (CETAP 1982; Waring et al. 2012), and is likely to be commonly encountered in the SRWEC–NYS. As noted above, Long Island Sound has been identified as potentially critical developmental habitat for immature Kemp's ridley sea turtles between two and five years of age (Morreale et al. 1992; NYSDEC n.d.), although Long Island Sound is not part of the Project Area.

Onshore Facilities

The Onshore Facilities portion of the Project will include crossing the ICW. All four species of sea turtles sighted in nearshore New York waters in the summer and fall (CETAP 1982; Kenney and Vigness-Raposa 2010; Kraus et al. 2016; NOAA Fisheries 2017) have the ability to utilize the available coastal habitat within the ICW and adjacent Great South Bay via openings in the barrier island. As previously described, six SAV observations were obtained from the SRWEC–ICW video footage during Summer 2020 site-specific surveys. These observations included small, solitary SAV shoots within a dense macroalgal mat observed on the north side of the SRWEC–ICW. No SAV beds were documented. Therefore, minimal to no foraging habitat will be crossed by the Project. However, Great South Bay contains a significant presence of eelgrass along the borders of Suffolk and Nassau Counties (NYSDEC 2020b), providing potential foraging opportunities for sea turtles. The loggerhead, green, and Kemp's ridley sea turtle have been documented as regularly foraging within Great South Bay's eelgrass beds (Audubon n.d.). The Kemp's ridley sea turtle has also been noted by the NYSDEC to be present, although infrequently, within Great South Bay (NYSDEC n.d.). These three species are therefore expected to have a regular presence within Great South Bay, and the ICW.

CONSTRUCTION AND OPERATIONS PLAN

Site Characterization and Assessment of Impacts – Biological Resources

4.4.5.2 Potential Impacts

Construction, O&M, and decommissioning activities associated with the SRWF, SRWEC, and Onshore Facilities have the potential to cause both direct and indirect impacts on sea turtles. IPFs associated with the construction and O&M phases of the Project are identified on Figure 4.4.5-2 and described separately, by phase, in the following sections. For the decommissioning phase of the Project, impacts are anticipated to be similar to or less adverse than those described for construction; therefore, impacts from decommissioning are not addressed separately in this section. As discussed in Section 4.2, above-water noise resulting from Project activities is not expected to be as intense as underwater noise and would only be fleeting. Additionally, while sea turtles do surface to breathe air, they spend most of the time submerged and are not expected to be exposed to above-water noise at levels that could result in biologically significant impacts. Therefore, the potential for above-water noise impacts to sea turtles is not discussed further in the assessment of impacts. Supporting information on sea turtle impacts are presented in Appendix I1 and Appendix O.

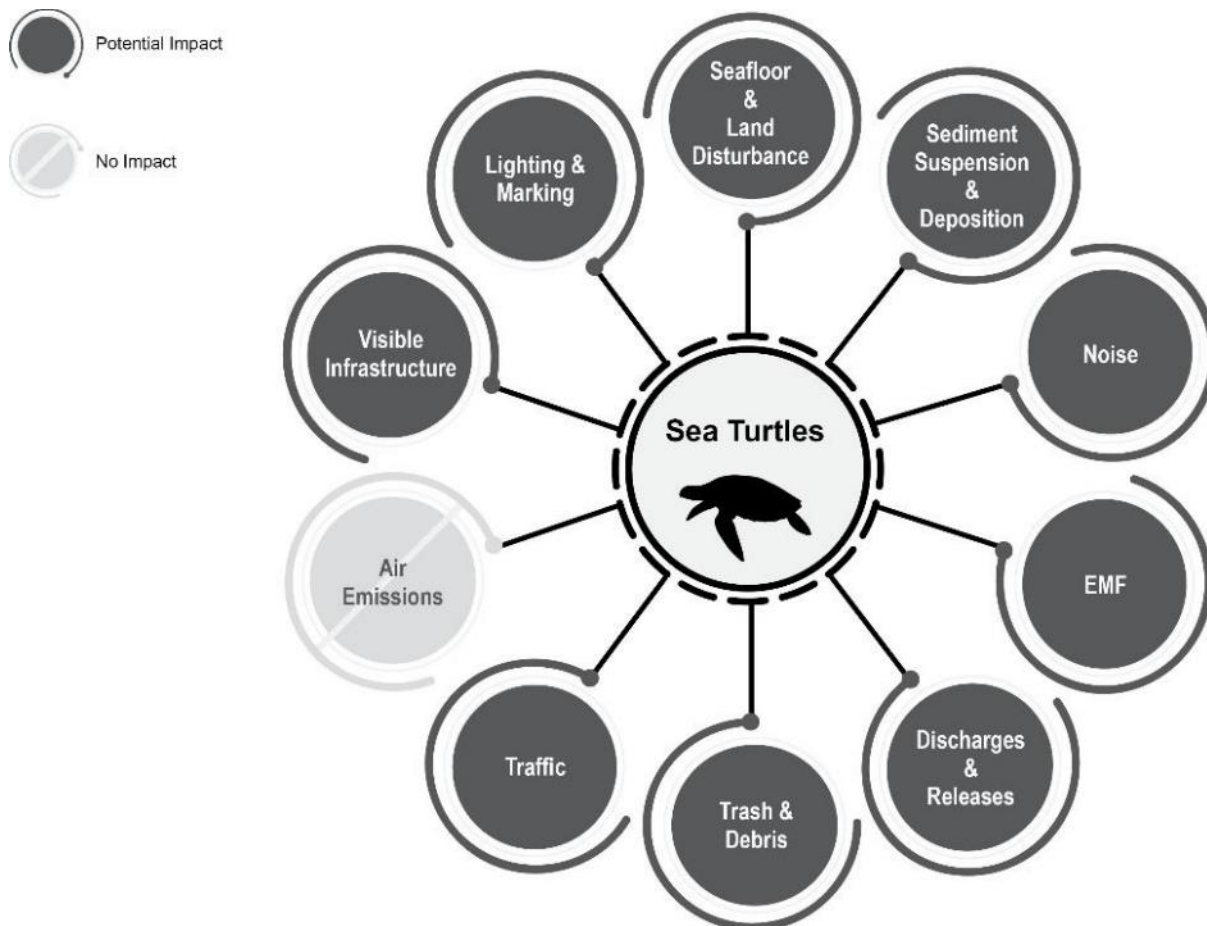

Figure 4.4.5-2 Impact-Producing Factors on Sea Turtles

CONSTRUCTION AND OPERATIONS PLAN

Site Characterization and Assessment of Impacts – Biological Resources

Sunrise Wind Farm

During construction and O&M of the SRWF, sea turtles are expected to experience impacts from seafloor disturbance, sediment suspension and deposition, noise, discharges and releases, trash and debris, traffic, and lighting. During O&M of the SRWF, sea turtles may additionally experience impacts from EMF and visible infrastructure. The potential impacts associated with each phase of the SRWF are addressed in the following sections.

Construction

IPFs resulting in potential impacts on sea turtles in the SRWF from the construction phase are assessed below.

Seafloor Disturbance

During construction of the SRWF, seafloor disturbances will be associated with seafloor preparation, placement of scour protection/cable protection, foundation installation, vessel anchoring and jack-up, and IAC installation. These seafloor disturbances could directly impact benthic species such as mollusks and crabs which are prey for sea turtles. As foundations, anchors, and/or jack-ups are placed on the seafloor, direct injury or mortality could occur to benthic species residing within the footprint of the foundations. As discussed for benthic resources (Section 4.4.2), it may take up to five years before stable communities are established following construction activities (Petersen and Malm 2006). However, the footprint of direct benthic impacts within the SRWF will be minimal when compared to the ample available bottom habitat surrounding the SRWF. Additionally, mobile benthic species are likely to vacate the area during construction activities, avoiding direct injury/mortality.

A number of methodologies for sand wave leveling and cable installation are being considered to prepare the seafloor and install the IAC within the SRWF (e.g., suction hopper dredge, mechanical plow, jet plow etc.; see Section 3.3). The suction hopper dredging technique recovers and relocates excavated materials from one location to another. A drag head is towed over the sand by a vessel while a pump “sucks” fluidized sand into the vessel’s storage hopper. Any sediment removed would be relocated within the local sand wave field along the IAC. Once full, the vessel will relocate to a designated storage or disposal area to offload materials. Excavation activities have the potential to disturb, catch, or constrain sea turtles that may not have moved away from the source of the activity quickly enough (Murray 2011). This potential impact is most likely to harm resting turtles offshore (and juveniles utilizing nearshore areas). However, the risk of being sucked up by the drag head or injury to sea turtles from hopper dredges in particular is expected to be lower in the open ocean, compared to within navigational channels (Michel et al. 2013; USACE 2020). This is likely due to the lower density of sea turtles likely to be found in offshore waters, and the ability to temporarily relocate to the available adjacent water. Consultations with agencies in development of environmental protection measures such as the use of PSOs, etc. (as detailed below) are likely to reduce risk of injury or mortality of individual sea turtles.

CONSTRUCTION AND OPERATIONS PLAN

Site Characterization and Assessment of Impacts – Biological Resources

Potential impacts to sea turtles from seafloor disturbance are therefore expected to include direct impact/injury to benthic prey, temporary loss of habitat for benthic prey species, and injury/mortality from use of installation techniques such as a suction hopper dredge. However, given the transient and short duration of construction activities (approximately 18 months), the wide availability of prey outside the SRWF, the ample available habitat surrounding the localized area of disturbances, and environmental protection measures, impacts on sea turtles from seafloor disturbances during construction of the SRWF are expected to be temporary and minimal.

Sediment Suspension and Deposition

SRWF construction activities associated with seafloor preparation, foundation installation, placement of scour protection/cable protection, vessel anchoring and jack-up, and IAC installation will directly result in temporary, localized increases in sediment suspension within the water column, which will increase turbidity. Increased turbidity could decrease visibility for sea turtles, potentially restricting predation efficiency. Additionally, the effects of turbidity on prey species (as discussed in Sections 4.4.2 and 4.4.3) could disrupt available forage for sea turtles and cause avoidance behavior within localized construction areas.

As described in Section 4.3.3, the extent of turbidity will depend on sediment type and size as well as the expected duration of the sediment disturbing activities. For example, sediment-disturbing activities in sandy substrates with larger (heavier) particles will typically result in shorter periods of elevated turbidity compared to similar work in areas with greater silt and clay content. The longer the disturbance continues, the longer the sediments are expected to be suspended within the water column.

Appendix H provides further information on suspended sediments from installation of the IAC in federal waters. As detailed in Sections 4.4.2 and 4.4.3, only short-term, limited impacts to fish and invertebrates are expected from suspended sediments; therefore, secondary effects on sea turtle prey availability are not expected. Furthermore, Appendix H concluded that TSS concentrations are predicted to return to ambient levels (<10 mg/L) within 0.5 hours following completion of IAC installation. The TSS plume is predicted to be contained within the lower portion of the water column, approximately 12.8-ft (3.9-m) above the seafloor. This limited temporal effect over a relatively small area are not expected to interfere with sea turtle foraging success.

Based on the relatively low anticipated density of sea turtles within the SRWF and the temporary and localized increases in turbidity expected, impacts on sea turtles are likely to be short-term and minimal during construction of the SRWF.

Noise

Sea turtles may be adversely impacted by underwater noise produced during the construction of the SRWF. The main sources of noise during the construction phase will be G&G surveys, MEC/UXO surveys (requiring potential HRG to locate MEC/UXOs), pile driving activities, and vessel traffic. Underwater noise could result in physiological and/or behavioral effects to sea turtles, including potential auditory injuries, temporary disturbance or displacement, and possible startle or stress responses. A detailed explanation of predicted noise levels is provided in Appendix I1.

CONSTRUCTION AND OPERATIONS PLAN

Site Characterization and Assessment of Impacts – Biological Resources

Limited research has been conducted on the physiological impacts of underwater sound on sea turtles, and very few data are available on the behavioral responses of sea turtles to noise. However, the data available suggest that sea turtles can detect and do behaviorally respond to acoustic stimuli (Dow Piniak et al. 2012a, b). While general hearing sensitivities for all species are below 2 kHz, primary hearing frequency ranges of sea turtle vary by species and life stage (Bartol and Ketten 2006; Bartol et al. 1999; Dow Piniak et al. 2012a, b; Martin et al. 2012; Piniak et al. 2016).

The studies available on underwater noise impacts to sea turtles examine the behavioral responses of loggerhead and green sea turtles to underwater noise produced by seismic guns. Behavioral responses observed during seismic surveys included avoiding the source of the sound (O'Hara and Wilcox 1990), startle reactions (DeRuiter and Doukara 2012), and increased swimming speeds (McCauley et al. 2000). Other possible behavioral responses could include increased surfacing time and decreased foraging. McCauley et al. (2000) reported that SPL of 166 dB re 1 μ Pa corresponded with observed behavioral reactions in sea turtles.

As explained in Appendix I1, BOEM and NOAA have adopted the sea turtle injury thresholds based on the dual criteria of SPL_{0-pk} and SEL_{cum} recommended by Popper et al. (2014) and the US Navy (Blackstock et al. 2018) and adopted by NOAA Fisheries (NOAA Fisheries GARFO 2016, 2020b). Table 4.4.5-2 summarizes the agency-adopted acoustic thresholds for sea turtles, which are used to evaluate noise impacts to sea turtles from impulsive sounds from impact pile driving and non-impulsive sounds generated by vessel traffic.

Table 4.4.5-2 Physiological and Behavioral Threshold Criteria for Impulsive and Non-Impulsive Sounds for Sea Turtles

Faunal Group	Sound Source Type	Injury Criteria Metric	Physiological Threshold	Behavior Criteria Metric	Behavioral Threshold
Sea Turtles	Impulsive sounds	SPL_{0-pk}	232 dB re 1 μ Pa	SPL	175 dB re 1 μ Pa
		$SEL_{cum, 24hr}$	204 dB re 1 μ Pa ² s		
	Non-impulsive sounds	SPL	180 dB re 1 μ Pa	SPL	175 dB re 1 μ Pa
SOURCE: Blackstock et al. 2018; GARFO 2016; NOAA GARFO 2020b; Popper et al. 2014					

Underwater acoustic modeling was conducted by Sunrise Wind to estimate the impacts produced from impact pile driving associated with foundation installation as this has been identified as the activity that will have the greatest potential for noise impacts on sea turtles. However, noise generated by G&G surveys and construction vessels has also been assessed qualitatively for potential impacts to sea turtles and are assessed in the subsections below.

CONSTRUCTION AND OPERATIONS PLAN

Site Characterization and Assessment of Impacts – Biological Resources

Impulsive Sounds – G&G Surveys

Short-term, localized HRG surveys during the construction period may include the use of multi-beam echosounders, side-scan sonars, shallow penetration sub-bottom profilers, medium penetration sub-bottom profilers and marine magnetometers. Site-specific verification has previously been conducted for geophysical equipment sound sources deployed within the marine portions of the Project Area. The survey equipment to be employed will be equivalent to the equipment utilized during the HRG survey campaigns associated with Lease Area OCS-A 0500 conducted in 2016, 2017, 2018, 2019, and 2020 and within Lease Area OCS-A 0487 conducted in 2019 and 2020 (CSA Ocean Sciences Inc. 2020).

Impulsive Sounds – MEC/UXO Clearance Surveys

As detailed in Section 3.3.3.4, prior to seafloor preparation, cable routing, and micro siting of all assets, the Project will implement a MEC/UXO Risk Assessment with RARMS designed to evaluate and reduce risk in accordance with the ALARP risk mitigation principle. The RARMS consists of a phased process beginning with a Desktop Study and Risk Assessment that identifies potential sources of MEC/UXO hazard based on charted MEC/UXO locations and historical activities, assesses the baseline (pre-mitigation) risk that MEC/UXO pose to the Project, and recommends a strategy to mitigate that risk to ALARP. Appendix G2 presents this study and strategies.

Avoidance is the preferred approach for MEC/UXO mitigation; however, it is anticipated that there may be instances where confirmed MEC/UXO avoidance is not possible due to layout restrictions, presence of archaeological resources, or other factors that preclude micro siting. In such situations, confirmed MEC/UXO may be removed through in-situ disposal or physical relocation. Selection of a removal method will depend on the location, size, and condition of the confirmed MEC/UXO, and will be made in consultation with a MEC/UXO specialist and in coordination with the appropriate agencies.

In-situ disposal will be done with low noise methods like deflagration of the MEC/UXO or cutting the MEC/UXO up to extract the explosive components. The MEC/UXO might also be relocated through a "Lift and Shift" operation, the relocation will be to another suitable location on the seabed within the APE or previous designated disposal areas for either wet storage or disposal through low noise methods as described for in situ disposal.

For all MEC/UXO clearance methods, safety measures such as the use of guard vessels, enforcement of safety zones, and others will be identified in consultation with a UXO/MEC specialist and the appropriate agencies and implemented as appropriate.

During Project construction, the likelihood of MEC/UXO encounter is very low. Sunrise Wind will work with BOEM to identify appropriate response actions, which may include developing an emergency response plan, conducting MEC/UXO-specific safety briefings, retaining an on-call MEC/UXO consultant, or other measures (See Appendix G2 for additional detail).

CONSTRUCTION AND OPERATIONS PLAN

Site Characterization and Assessment of Impacts – Biological Resources

Impulsive Sounds – Impact Pile Driving

Underwater noise from the impulsive sounds generated by impact pile driving is considered an important IPF in potential physiological and behavioral impacts on sea turtles. The assessment of potential acoustic impacts to sea turtles was completed based on the results of underwater acoustic and animal movement modeling studies specific to proposed Project construction activities. Appendix I1 provides predicted sound propagation distances based on key construction variables associated with the Project design envelope, such as hammer type, pile type, pile schedule (hammer energy/number of strikes/piling duration), season, geographic location, and implementation of noise mitigation (i.e., sound attenuation) measures. Appendix O additionally summarizes the results of the models and provides an impact assessment based not only on underwater sound characteristics but aspects of the marine environment that influence sound propagation, autecological characteristics of at-risk species, mitigation factors, and sea turtle behavior.

As a part of the Appendix I1 modeling study, impacts to marine mammals, sea turtles, and sturgeon were assessed. Within this assessment, the JASMINE model was utilized to predict the probability of exposure of animals to sound arising from pile driving operations during construction activities. Simulated animals (animats) were used to sample predicted three-dimensional sound fields derived from animal movement observations. Predicted sound fields were sampled so that animats were programmed to behave like marine species are expected to, and the output provided an exposure history for each animat included within the simulation. Both SPL_{pk} and SEL_{cum} were calculated for each species based on corresponding acoustic criteria.

The acoustic ranges to the SEL_{cum} physiological threshold assumed an animal is stationary within the propagated sound field and thus accumulates noise levels for the full 24-hour period. When realistic animal behavior and movement are considered, the risk of exposure to accumulated noise levels that have the potential to cause a physiological impact is lower.

Distances to the SEL_{cum} physiological onset thresholds that take animal movement into account are called exposure-based distances. Because sea turtles are not expected to be stationary in the area during construction, the exposure-based distances are considered a more realistic prediction of distances to the threshold criteria provided in Table 4.4.4-2, compared to the acoustic ranges in which sound propagation is estimated based on a stationary receiver (i.e., animal) (Appendix I1). Therefore, results of modeled exposure ranges are provided in Appendix O.

The exposure-based distances to SEL_{cum} physiological onset thresholds (Appendix I1) indicate that the different sea turtle species experience similar risks of exposure to noise sufficient to elicit physiological impacts. However, the SEL_{cum} threshold assumes an animal experiences accumulated noise above the threshold level for 24 hours. When animal movement and behavior are taken into account, the risk of physiological impacts on sea turtles is low since it is not expected that an animal will remain within the area ensounded by above-threshold underwater noise for the entire piling period. The most likely impact expected during impact pile driving is behavioral disturbances given the estimated threshold distances for sea turtle species. Seasonality (i.e., the highest sea turtle densities in summer and fall) is an important parameter when estimating exposures to potentially harmful underwater noise due to the variable monthly densities of animals in the SRWF.

CONSTRUCTION AND OPERATIONS PLAN

Site Characterization and Assessment of Impacts – Biological Resources

Behavioral effects are likely to consist of turtles vacating the active construction area; however, these impacts are not expected to be long-term or biologically significant. Exposure range distances detailed in Appendix I1 reflect the expected attenuation achieved using noise mitigation devices employed by Sunrise Wind, the implementation of mitigation measures, and the variability in source levels as the pile reaches target penetration depth.

Based on exposure ranges, the low sea turtle density estimates in the SRWF, and the additional proposed environmental protection measures outlined below, impacts to sea turtles during impact pile driving are likely to be short-term behavioral disruptions.

Non-impulsive Sounds – Vessel Traffic

Commercial and recreational vessels can produce varying SPLs dependent on the overall size, engine, propeller size, and configuration. These vessels can create LF noises that can be detected by turtles (Dow Piniak et al. 2012b). While the SPLs created may not directly damage hearing, the presence of vessels within sea turtle habitat may mask important auditory cues. Similarly, vessels associated with construction of the SRWF will create underwater sound likely perceivable by sea turtles. Vessels expected to be present during construction of the SRWF, as outlined in Sections 3.3.9.4 and 4.8.1, include construction barges, support tugs, jack-up rigs, supply/crew vessels, and cable laying vessels. As detailed in Table 3.3.10-3, a total of 14 vessel types (43 vessels) are estimated to support SRWF construction activities; however, not all vessels associated with construction activities will be deployed at one time.

Construction is also anticipated to take place within specified work windows, which will limit the number of vessels added to the local traffic levels at one time. Therefore, it is presumed that individuals or groups of sea turtles in the area are familiar with various and common vessel-related noises and will not be further impacted by incremental Project-related vessel traffic. If impacts occur to sea turtles from Project-related vessel noise, they are not expected to be biologically significant and would be limited to short-term disruption and displacement of individuals from localized areas around the vessels. Therefore, impacts of underwater sound generated from most construction vessels on sea turtles are expected to be minimal.

Non-impulsive Sound—Aircraft

Helicopters may be used for crew changes during installation of the SRWF. Helicopters will generally fly at altitudes above those that would potentially result in behavioral effects. In cases where the helicopter must fly below these altitudes to land or take off, or inspect Project components, any behavioral effects to sea turtles would be direct and immediate with no long-term effects to individuals or populations. Additional details on helicopter operations can be found in Sections 3.3.9.4, 3.5.5, and 4.8.1.

Discharges and Releases

Project-related marine vessels operating during construction will be required to comply with regulatory requirements for management of onboard fluids and fuels, including prevention and control of discharges. Trained, licensed vessel operators will adhere to navigational rules and regulations, and vessels will be equipped with spill containment and cleanup materials. Additionally, Sunrise Wind will comply with applicable international (IMO MARPOL), federal (USCG), and state (NY) regulations and standards for treatment and disposal of solid and liquid

CONSTRUCTION AND OPERATIONS PLAN

Site Characterization and Assessment of Impacts – Biological Resources

wastes generated during all phases of the Project. As described in Appendix E1, some liquid wastes will be permitted as discharge into marine waters (i.e., domestic water, deck drainage, treated sump drainage, uncontaminated ballast water, and uncontaminated bilge water); these are not expected to pose an adverse impact to marine resources as they will quickly disperse, dilute, and biodegrade (BOEM 2013).

All vessels will similarly comply with USCG standards regarding ballast and bilge water management. Liquid wastes from vessels (including sewage, chemicals, solvents, and oils and greases from equipment) will be properly stored, and disposal will occur at a licensed receiving facility. As required by 30 CFR § 585.626, chemicals to be utilized during the Project are provided in Appendix E1, and in Table 3.3.1-2 and Table 3.3.6-2. Any unanticipated discharges or releases are expected to result in minimal, temporary impacts; activities are heavily regulated and unpermitted discharges are considered accidental events that are unlikely to occur. In the unlikely event that a reportable spill were to occur, the National Response Center would be notified, followed by the EPA, BOEM, and USCG as outlined in Appendix E1.

As previously discussed, multiple vessels will be used during the construction of the SRWF. Accidental discharges and releases represent a risk factor to sea turtles because sea turtles could potentially ingest contaminants within the water causing injury or mortality, depending on the type and amount of contaminant. However, impacts to sea turtles from discharges and releases are likely to be minimal due to the low likelihood of such non-routine and accidental events and the environmental protection measures in place.

Trash and Debris

Any active vessel operating within a marine environment has the potential to create trash and debris. However, the discharge or disposal of solid debris into offshore waters from OCS structures and vessels is prohibited by BOEM (30 CFR § 250.300) and the USCG (MARPOL, Annex V, Pub. L. 100-220 [101 Stat. 1458]). In accordance with applicable federal, state, and local laws, Sunrise Wind will implement comprehensive measures prior to and during Project construction activities to avoid, minimize, and mitigate impacts related to trash and debris disposal. All trash and debris will be properly stored on vessels for later disposal on land at an appropriate facility per 30 CFR § 585.626(b)(9). Trash and debris will be contained on vessels and offloaded at port or construction staging areas. Food waste that has been ground and can pass through a 25-mm mesh screen may be disposed of according to 33 CFR § 151.51-77. All other trash and debris returned to shore will be disposed of or recycled at licensed waste management and/or recycling facilities. Disposal of any other form of solid waste or debris in the water will be prohibited, and good housekeeping practices will be implemented to minimize trash and debris in vessel work areas. These practices will include orderly storage of tools, equipment, and materials as well as proper waste collection, storage, and disposal to keep work areas clean and minimize potential environmental impacts. Depending on the type of trash or debris, sea turtles could become entangled or ingest foreign materials, causing injury or mortality. However, with proper waste management procedures, the potential for trash or debris to be inadvertently left overboard or introduced into the marine environment is not anticipated.

CONSTRUCTION AND OPERATIONS PLAN

Site Characterization and Assessment of Impacts – Biological Resources

Vessel Traffic

As stated in Section 3.2.2, Project installation is scheduled to take place over a one- to two-year period. The largest vessels are expected during the WTG installation phase, with floating/jack-up crane barges, cable-laying vessels, supply/crew vessels, and associated tugs and barges transporting construction equipment and materials. Large work vessels for foundation and WTG installation will generally transit to the work location and remain in the area until installation is complete. These large vessels will move slowly and over short distances between work locations. Construction activities will also require the support of several smaller, faster moving vessels (e.g., CTV and other small supply vessels) that will move continuously throughout the SRWF. Vessels will also travel between the SRWF and several potential ports in New York, Connecticut, Maryland, Massachusetts, New Jersey, Rhode Island, and Virginia over the course of the construction period. Potential ports expected to be utilized by the construction of the SRWF are detailed in Appendix K, along with estimated vessel trips per construction activity. Additionally, Table 3.3.10-3 details 14 vessel types (with 43 vessels total) proposed for construction activities; however, not all vessels associated with construction activities will be deployed at one time.

Appendix X shows existing traffic conditions in the assessment area (defined as the largest practical footprint of Sunrise Wind offshore structures within the Lease Area), based on one year of AIS data (July 2018 through June 2019), and collected from 28 transects. Results showed that most transects have very low traffic levels of less than 10 transits per day (i.e., less than 3,650 transits per year). However, two transects showed comparatively higher levels of traffic, each with an average of 35 to 38 transits per day (13,000 per year). Results also showed seasonal differences in existing traffic levels, with the highest traffic levels occurring in the summer. As detailed in Sections 3.3.9.4 and 4.8.1, and Appendix X, Project-related traffic is expected to result in only a temporary increase in existing traffic at any given point in time. However, non-Project related traffic is also expected to increase, as traffic that may be generated by the presence of the SRWF could result in approximately 100 additional recreational vessels per year (Appendix X).

Impingement of sea turtles in towed equipment and between vessels and equipment has been identified in seismic surveys (Nelms et al. 2016) and excavation operations (Dickerson et al. 2004); however, direct sea turtle impacts such as these are rare, particularly if the proper environmental protection measures are followed. The primary threat to sea turtles from temporary increased vessel traffic is the potential for accidental vessel strikes, which could result in injury or mortality. Sea turtles swimming or feeding at or near the surface of the water can be vulnerable to vessel strikes as propeller and collision injuries to sea turtles from boats or vessels are not uncommon (NOAA Fisheries and USFWS 1991). It is estimated that approximately 50 to 500 turtle mortalities per year in US waters result from collisions with vessels (Plotkin et al. 1995). Vessel strikes happen when either the turtle or the vessel fails to detect the other in time to avoid the collision. Variables that contribute to the likelihood of a collision include vessel speed, vessel size and type, and visibility.

CONSTRUCTION AND OPERATIONS PLAN

Site Characterization and Assessment of Impacts – Biological Resources

Sea turtles can detect approaching vessels, likely by sight rather than by sound, and seem to react more to slower moving vessels (2.2 knots [4.1 km/h]) than to faster vessels (5.9 knots [10.9 km/h] or greater) (Hazel et al. 2009). When a vessel is large, traveling at a high speed, or located in a geographic bottleneck such as a narrow strait, mortality is more likely (Laist et al. 2001; Work et al. 2010). However, sea turtles may not be able to avoid all collisions, and injury or mortality from vessels is possible. Sea turtle vessel strike injuries that result in mortality are often difficult to determine due to the nature of post-mortem injuries on recovered carcasses.

Some sea turtle species and life stages are more susceptible to vessel strikes than others. For example, loggerhead juveniles found in coastal waters during foraging and resting are highly susceptible to vessel strikes. Similarly, smaller turtles such as the Kemp's ridley green, and loggerhead turtles may be difficult to see in the water (Kenney and Vigness-Raposa 2010). Kemp's ridley turtles and loggerhead turtles are additionally impacted more heavily by drops in water temperature resulting in cold-stunning where their diving capacities constrain them to a floating, motionless presence at the water's surface (Burke et al. 1991; Hochscheid et al. 2010; Meylan and Sadove 1986), which makes them more prone to vessel strikes. Leatherback sea turtles residing near coastal areas in the summer season or offshore have a higher susceptibility to vessel strikes due to the increased number of transiting vessels during that time of year and their co-located positioning with the large turtles (Kenney and Vigness-Raposa 2010).

Additionally, as previously stated, the number of vessels operating for construction of the SRWF is expected to be relatively low, and the increase in traffic due to construction will be temporary. Given the seasonal distribution of sea turtles in this region, the relatively low abundance of sea turtles in local waters (Kenney and Vigness-Raposa 2010; NOAA SEFSC 2020), planned consultation with applicable federal and state agencies, and the implementation of environmental protection measures (such as speed restrictions and following BOEM and NOAA guidance for strike avoidance), the chance of Project vessels striking sea turtles during temporary construction activities is relatively low.

Lighting and Marking

Artificial lighting during SRWF construction will be associated with navigational and deck lighting on Project vessels from dusk to dawn. Reaction of sea turtles to this artificial light is dependent on species-specific and environmental factors that are impossible to predict but may include either attraction (including in response to attracted prey) or avoidance of a lit area. Because of the low anticipated density of sea turtles in the area, the limited area associated with the artificial lighting used on Project vessels relative to the surrounding unlit areas, and the short-term and transient nature of construction vessel activities, the impacts to sea turtles are likely to be temporary and minimal. Furthermore, lighting during construction activities will be limited to the minimum required by the BOEM and USCG for safety during construction activities and to minimize impacts to other wildlife, such as birds.

Operations and Maintenance

IPFs resulting in potential impacts on sea turtles in the SRWF from the O&M phase are assessed below.

CONSTRUCTION AND OPERATIONS PLAN

Site Characterization and Assessment of Impacts – Biological Resources

Seafloor Disturbance

Seafloor disturbance during O&M of the SRWF will primarily result from vessel anchoring and jack-up and any maintenance activities that will require exposing and reburying the IAC. Both activities are expected to be non-routine events and are not expected to occur with any regularity. Seafloor disturbance resulting from vessel activity during SRWF O&M are expected to be similar to, but on a smaller scale than, seafloor impacts described for the construction phase.

Sediment Suspension and Deposition

Any maintenance activities that will require exposing and reburying the IAC, and the use of vessel anchoring and jack-up, may result in increases in sediment suspension and deposition, which may temporarily increase turbidity in the water column. These activities are expected to be non-routine events and are not expected to occur with any regularity. Sediment suspension and deposition impacts resulting from vessel activity during SRWF O&M are expected to be similar to vessel-related sediment suspension and deposition impacts described for the construction phase.

Noise

Direct impacts to sea turtles associated with noise during O&M of the SRWF may result from vessel noise during routine and non-routine maintenance trips. However, these are expected to be similar to, but lesser than, vessel noise impacts described for construction of the SRWF owing to the reduced number of vessels anticipated during this phase of the Project.

Non-impulsive Sound—Wind Turbine Generator Noise

Potential impacts on sea turtles from operational noise produced by the WTGs may include avoidance of the SRWF, disorientation, and disruption of feeding behaviors (MMS 2007). In contrast to the short-term duration of construction activities, noise generated during normal operation will persist over the operational life of the Project (i.e., approximately 25 to 35 years). Adults and juveniles are expected to be able to avoid the operational noises of the SRWF by swimming away from any disturbances, however hatchlings which are passively traveling through the area on currents may not be able to actively vacate areas of disturbance, thus subjecting them to long-term exposure to WTG noise (MMS 2007).

As previously described, available data on hearing sensitivities in sea turtles suggest they are able to detect low frequency noises below 1 or 2 kHz (Bartol and Ketten 2006; Bartol et al. 1999; Dow Piniak et al. 2012a, b; Martin et al. 2012; Piniak et al. 2016). Measurement of operational WTG noise show between 3 and 10 dB increases in SPL in frequencies below 100 Hz, and maximum SPL occurred at 50, 160, and 200 Hz (HDR 2019; Thomsen et al. 2006). Given this information, it is likely sea turtles may be able to detect WTG noise. However, analysis of recent data collected for the Block Island Wind Farm concluded that measured SPL were generally below 120 dB re 1 μ Pa 164-ft (50-m) from WTGs except at wind speeds greater than 13 m/sec (HDR 2019). The current acoustic threshold for behavioral responses in sea turtles is an SPL of 175 dB re 1 μ Pa (Blackstock et al. 2018). Therefore, even if sea turtles can detect WTG noise, it is unlikely they will experience behavioral disturbances as a result.

CONSTRUCTION AND OPERATIONS PLAN

Site Characterization and Assessment of Impacts – Biological Resources

Additionally, the presence of the SRWF foundations is expected to create beneficial foraging and sheltering habitat. While the impacts of long-term noise exposure on sea turtles is generally unknown, the sound levels produced during operation are expected to be less than the behavioral and physiological thresholds for sea turtles, so it is unlikely long-term avoidance of the SRWF and surrounding area will occur. Impacts on sea turtles are likely to be direct and long-term, but minimal.

Vessel Traffic Noise

Throughout the operational life of the SRWF, Project vessels will undergo routine maintenance trips between potential ports in New York and Rhode Island and the SRWF (see Section 3.3.9.4 and 3.5.5 for additional information on nearby ports).

Noise produced by O&M vessels may be masked by other anthropogenic activity in the area. As previously stated, given the Project location relative to major commercial shipping lanes, there is not expected to be a significant disruption to the normal traffic patterns due to occasional and temporary vessel traffic associated with O&M. Additionally, given the seasonal distribution of sea turtles in this region (Kenney and Vigness-Raposa 2010; NOAA SEFSC 2020), planned consultation with applicable federal and state agencies, and the implementation of environmental protection measures (such as speed restrictions and following BOEM and NOAA guidance for strike avoidance) outlined below, the chance of Project vessels striking sea turtles during temporary O&M activities is relatively low.

Impulsive Sound—G&G Surveys

Short-term, localized impacts from HRG surveys during O&M may occur from the use of multi-beam echosounders, side-scan sonars, shallow penetration sub-bottom profilers, medium penetration sub-bottom profilers, and marine magnetometers. The indicative frequency of seafloor surveys during O&M is provided in Section 3.5, and site-specific verification of geophysical equipment sound sources has been conducted. The survey equipment to be employed will be equivalent to the equipment utilized during the HRG survey campaigns associated with Lease Area OCS-A 0500 conducted in 2016, 2017, 2018, 2019, and 2020 and with Lease Area OCS-A 0487 conducted in 2019 and 2020 (CSA Ocean Sciences Inc. 2020).

Electric and Magnetic Fields

Sea turtles are highly migratory and undergo trans-oceanic migrations during certain periods of their lives. Hatchlings swim from beaches into open ocean, juveniles migrate to and from seasonal habitats, and adults will leave feeding grounds to mate and migrate back to their natal beaches (Lohmann et al. 1999). To navigate and orient themselves, sea turtles are known to use the Earth's magnetic fields, typically referred to as "geomagnetic sensitivity" as opposed to "electro sensitivity" (Normandeau et al. 2011). Sea turtles can detect two different features of the geomagnetic field, including inclination angle and intensity (Lohmann et al. 2008; Lohmann and Lohmann 1994). These fields vary across the Earth's surface, and turtles can derive positional information from these fields.

CONSTRUCTION AND OPERATIONS PLAN

Site Characterization and Assessment of Impacts – Biological Resources

Sea turtles may use these fields in two different ways: (1) as a magnetic compass, for directional sense that enables them to establish a heading and maintain their course; and (2) for positional information, where turtles can approximate their position within the ocean (Lohmann et al. 1997; Lohmann and Lohmann 1996). Multiple studies have demonstrated magneto-sensitivity and behavioral responses to field intensities ranging from 0.0047 to 4,000 microteslas (μT) (.047 to 40,000 mG) and 29.3 to 200 μT (293 to 2,000 mG) for loggerheads and green turtles, respectively (Normandeau et al. 2011). Luschi et al. (1996) placed magnets on the heads of sea turtles to mask the Earth's magnetic fields, and results showed that sea turtles were still capable of returning home; however, their routes were less direct than the control group (Luschi et al. 1996; Normandeau et al. 2011).

Once energized, the Project cables will produce a magnetic field and an induced electric field that will decrease in strength rapidly with distance. The IAC will be AC, and while the OCS-DC will not be a source of EMF in the marine environment itself, several cables come into this structure and will be a source of EMF when energized. As detailed in Appendix J1, the magnetic fields and induced electric fields from operational AC cables will decrease quickly with increasing distance. At a height of 3.3 ft (1 m), directly over the cables at peak loading, AC magnetic- and induced electric-field levels were calculated to 4.5 mG and < 0.1 mV/m, decreasing to 1.1 mG and < 0.1 mV/m or less at a horizontal distance of ± 10 ft (3 m) from the cables. Furthermore, previous literature on the subject (e.g., Hutchison et al. 2018; Silva 2006;) make it clear that the magnetic fields and induced electric fields are generally lower as distance from the cables increases.

Within the SRWF, sea turtles are most likely to encounter EMF from the IAC if feeding on benthic organisms or resting on the seafloor above the cable. Direct adverse effects to sea turtles from submarine power cables have not been documented (BOEM 2019b), and because these species must surface to breathe, sea turtles are expected to limit extended periods of time spent resting or foraging directly on subsea cables.

Indirect effects on sea turtles from alterations in prey due to EMF are also unlikely as the average magnetic-field strengths of AC cables are far below levels documented to have adverse impacts to fish behavior (see Appendix J1). AC undersea power cables associated with offshore wind energy projects within the southern New England area will generate weak EMF at frequencies outside the known range of detection by electrosensitive and magnetosensitive fishes (Normandeau et al. 2011). As detailed in Section 4.3.5, fish species, including small schooling fish (e.g., mackerel, herring, capelin) consumed by sea turtles, would not be affected by the EMF associated with Project cables. Most fishery species in the southern New England area are bony fishes, which have not evolved to detect EMF at 60 Hz (Snyder et al. 2019).

Furthermore, the broad scale of sea turtle migrations and the generally low density of individuals within a given area are also expected to lower the likelihood that individuals will regularly encounter Project-associated EMF. The broad distribution and movement of sea turtles also implies that the SRWF represents a very small portion of the available habitat for migratory sea turtles.

CONSTRUCTION AND OPERATIONS PLAN

Site Characterization and Assessment of Impacts – Biological Resources

Discharges and Releases

Impacts from accidental discharges and releases during O&M are expected to be similar to, but of lesser likelihood than during, construction as there will be fewer Project-related marine vessels during this phase, and regulatory requirements and preventative measures will still apply. Unpermitted discharges or releases are considered accidental events, and in their unlikely occurrence, these are expected to result in minimal, temporary impacts. Permitted discharges are not expected to pose an adverse impact to marine resources as they will quickly disperse, dilute, and biodegrade (BOEM 2013).

Additionally, seawater cooling will be needed for the OCS–DC (Section 3.3.6.1). During operation, the OCS–DC will require continuous cooling water withdrawals and subsequent discharge of heated effluent back to the receiving waters. The maximum DIF and discharge volume is 8.1 million gallons per day with AIF and discharge volumes that are dependent on ambient source water temperature and facility output. Preliminary hydrodynamic modelling indicates that there will be some highly localized increases in water temperature in the immediate vicinity of the discharge location of the OCS–DC. The design, configuration, and operation of the CWIS for the OCS–DC will be permitted as part of an individual NPDES permit and additional details will be included in the permit application submitted to the EPA. This will include final results of the hydrodynamic modelling.

Trash and Debris

There may be an increase in fish aggregations around the foundations and scour protection as a result of habitat conversion (see Visible Infrastructure below). This could attract commercial and recreational fishing to the area, which could pose an inadvertent threat to sea turtles through entanglement or ingestion of fishing gear or through incidental bycatch. Greater fishing efforts around the operating SRWF would increase the amount of equipment in the water, increasing the risk of sea turtles ingesting or becoming entangled in this discarded equipment (Barnette 2017).

Impacts from marine disposal of trash and debris during O&M are expected to be similar to, but of lesser likelihood than during, construction, as there will be fewer Project-related marine vessels during this phase, and regulatory requirements and preventative measures will still apply. However as described below, there may be an increased number of fishing vessels around the operating SRWF which could increase the likelihood of vessel trash and debris. The unanticipated marine disposal of trash and debris is considered an unpermitted, accidental event, and containment and good housekeeping practices will be implemented to minimize the potential.

CONSTRUCTION AND OPERATIONS PLAN

Site Characterization and Assessment of Impacts – Biological Resources

Vessel Traffic

Sunrise Wind expects to use a variety of vessels to support O&M, including SOVs with deployable work boats (daughter craft), CTVs, jack-up vessels, and cable laying vessels. Section 3.5.5 provides a summary of O&M vessels currently being considered for support of O&M activities. Although the type and number of vessels will vary over the operational lifetime of the Project, five vessel types are currently being considered for O&M of the SRWF (three for routine activities and two for non-routine activities). There will be fewer vessels used for routine maintenance trips than used for construction or non-routine maintenance, but they will occur over a longer period considering the 25- to 35-year operational life of the Project. Non-Project traffic generated by the presence of the WTGs may also increase due to the presence of the WTGs. Safety or exclusion zones are not anticipated during the operation of the Project, therefore both Project and non-Project vessels will be free to navigate within, or close to, the WTGs.

As previously described, the primary threat to sea turtles from increased vessel traffic is the potential for accidental vessel strikes, which could result in injury or mortality. Sea turtles swimming or feeding at or near the surface of the water can be vulnerable to vessel strikes as propeller and collision injuries to sea turtles from boats or vessels are not uncommon (NOAA Fisheries and USFWS 1991). However, to monitor the number of vessels and traffic patterns for analysis and compliance with vessel speed requirements, the Project will require operational AIS on all vessels associated with the Project pursuant to USCG and AIS carriage requirements. AIS will be used to monitor the number of vessels and traffic patterns for analysis and compliance with vessel speed restrictions. All vessels will operate in accordance with applicable rules and regulations for maritime operation within US and federal waters. Additionally, the Project will adhere to vessel speed restrictions as appropriate in accordance with BOEM and NOAA requirements. The implementation of vessel strike avoidance measures for sea turtles and for marine mammals (outlined in Section 4.4.4) will additionally serve to reduce the risk of collisions with sea turtles in the SRWF so that the potential long-term impacts will be minimal.

Visible Infrastructure

Structural elements of the SRWF will be present for the 25- to 35-year operational life of the Project. Once WTGs and OCS-DC have foundations have been installed within the seafloor, the presence of the operating SRWF will have converted the existing open water habitat to one with increased hard bottom, making it comparable to an artificial reef-like habitat. The presence of the SRWF foundations, scour protection, and IAC protection will create three-dimensional hard bottom habitats resulting in a reef effect that is expected to attract numerous species of algae, shellfish, finfish, and sea turtles (Langhamer 2012; Reubens et al. 2013; Wilhelmsson et al. 2006). Sea turtles have been observed within the vicinity of offshore structures, such as oil platforms, foraging and resting under the platforms (Gitschlag and Herczeg 1994; NRC 1996). High concentrations of sea turtles have been reported around these oil platforms (NRC 1996), and approximately 170 sightings were reported during a surface survey at a platform off the coast of Galveston, Texas (Gitschlag 1990).

CONSTRUCTION AND OPERATIONS PLAN

Site Characterization and Assessment of Impacts – Biological Resources

As a result of the increased habitat and foraging opportunities at the now artificial reef-like habitat, sea turtles could potentially remain in areas longer than they normally would and could become susceptible to cold stunning or death. However, artificial habitat created by these offshore structures can provide multiple benefits for sea turtles, including foraging habitats, shelter from predation and strong currents, and methods of removing biological build-up from their carapaces (Barnette 2017; NRC 1996). It is estimated that offshore petroleum platforms in the Gulf of Mexico, provided an additional 2,000 mi² (5,180 km²) of hard bottom habitat (Gallaway 1981). Wakes created by the presence of the foundations may influence distributions of drifting jellyfish aggregations; however, since other prey species available to sea turtles will not be affected by these wakes, impacts on sea turtle foraging are not expected to be substantial (Kraus et al. 2019).

Lighting and Marking

Artificial lighting during O&M will be associated with vessels, the WTGs, and the OCS–DC. Lighting on the WTG foundations and the OCS–DC will be coordinated with the USCG to meet appropriate safety standards and to minimize potential impacts on marine organisms. It is likely that reaction of sea turtles to this artificial light is species- and individual-dependent and may include short-term attraction or avoidance of an area, similar to that discussed for construction. Some sea turtle species may also be attracted to the structures for foraging opportunities if fish or plankton are attracted to light sources. However, because of the limited area associated with the artificial lighting used on Project vessels, the WTGs, and the OCS–DC, relative to the surrounding unlit regional area, the potential impact is considered either direct or indirect, and short-term.

Sunrise Wind Export Cable

During construction of the SRWEC, sea turtles may experience impacts from seafloor disturbance, sediment suspension and deposition, noise, discharges and releases, trash and debris, vessel traffic, and lighting. The only difference in potential impacts between construction of the offshore (SRWEC–OCS) and nearshore (SRWEC–NYS) sections is the use of HDD methodology where the SRWEC–NYS makes landfall on Fire Island. During O&M of the SRWEC, sea turtles are expected to experience seafloor disturbance, sediment suspension and deposition, noise, EMF, and vessel traffic, with impacts generally comparable between offshore and nearshore sections. Although potential impacts to sea turtles are generally expected to be the same across OCS and NYS portions of the SRWEC, some species are more likely to be found in either nearshore or offshore environments based on their habitat preferences and current life stage. The following sections outline how construction and O&M of the SRWEC will impact the four species most likely to be found within these waters.

Construction

IPFs resulting in potential impacts on sea turtles in the SRWEC–NYS and SRWEC–OCS from the construction phase are assessed below.

Seafloor Disturbance

Installation of the SRWEC will include the following activities: seafloor preparation, cable installation, installation of cable protection, and anchoring vessels.

CONSTRUCTION AND OPERATIONS PLAN

Site Characterization and Assessment of Impacts – Biological Resources

Impacts for seafloor preparation for the installation of the SRWEC will be the same as previously described for construction of the OCS–DC and IAC. To prepare the seafloor, sand waves along the route may be leveled via a suction hopper dredge or via CFE. Cable installation techniques include mechanical plowing, jet plowing, pre-cut mechanical plowing, pre-cut dredging, mechanical cutting, and/or CFE. These methods and anticipated maximum disturbance corridors during construction are detailed in Section 3.3.

As previously described, equipment used for preparation of the seafloor, installing the SRWEC, and anchors being dropped from vessels could disturb, catch, or constrain sea turtles causing injury or mortality. The equipment would also be removing localized portions of the seafloor that may contain benthic prey, causing sea turtles to temporarily relocate for forage.

Therefore, impacts on sea turtles due to seafloor disturbance for construction of the SRWEC could include accidental injury/mortality from construction equipment, and displacement of benthic prey species. These impacts are expected to be localized and temporary. After installation of the SRWEC, the surrounding environment is expected to return to near baseline conditions over time. Furthermore, the footprint of the SRWEC corridor will be relatively small compared to the ample surrounding open ocean habitat, and the implementation of environmental protection measures detailed below would further reduce impacts to sea turtles.

Sediment Suspension and Deposition

As previously described, installation of the SRWEC will require the excavation of the seafloor within the route corridor in OCS and NYS waters. These seafloor disturbing activities are expected to result in localized increases in suspended sediments and, therefore, increased turbidity levels. As previously described for the SRWF, increased turbidity can decrease visibility and water quality around the SRWEC, decreasing sea turtle foraging efficiency and potentially forcing them to temporarily relocate.

As further detailed in Appendix H, sediment transport modeling was completed for the installation of the SRWEC in both offshore and nearshore waters.

Installation of the SRWEC–OCS considered the release of 254,360 m³ (332,690 cy) of sediment to the water column over the approximate 94-mi (151.3-km) length of the modeled SRWEC cable corridor centerline for a duration of 18.7 days. Results indicated maximum suspended sediment concentrations greater than 100 mg/L occurring within 2,969 ft (905 m) of the cable corridor centerline. TSS concentrations were then predicted to return to ambient levels (<10 mg/L) within 0.4 hours from completing the installation. The maximum predicted deposition thickness was 289 mm (11.4 in). Sedimentation at or above 10 mm (0.4 in) extended a maximum distance of 791 ft (241 m) from the cable corridor centerline and covered an area of 337 ha (832.3 acres) of the seafloor. The TSS plume is predicted to be contained within the lower portion of the water column, approximately 9.8-ft (3.0-m) above the seafloor.

For modeling of the SRWEC–NYS installation, the sediment transport modeling effort considered the release of 14,481 m³ (8,940 cy) of sediment to the water column for a duration of 20.4 hours. Results indicated maximum suspended sediment concentrations greater than 100 mg/L do not occur. TSS concentrations were predicted to return to ambient levels (<10 mg/L) within 0.34 hours from completing the installation. The maximum predicted deposition thickness was 191 mm (7.5 in).

CONSTRUCTION AND OPERATIONS PLAN

Site Characterization and Assessment of Impacts – Biological Resources

Sedimentation at or above 10 mm (0.4 in) extended a maximum of 253-ft (77-m) from the cable corridor centerline and covered an area of 21.5 ha (53.1 acres) of the seafloor. Similar to the SRWEC–OCS, the TSS plume for SRWEC–NYS installation is predicted to be contained within the lower portion of the water column, approximately 8.5-ft (2.5-m) above the seafloor.

Additionally, HDD (as described in Section 3.3.3) will occur within nearshore NYS waters when the SRWEC makes landfall on Fire Island. In general, this will involve drilling horizontally under the seafloor and intertidal zone using a drilling rig that will be located onshore within a designated Landfall Work Area

Drilling fluid (comprised of bentonite, drilling additives, and water) will be pumped to the drilling head to stabilize the created hole. Drilling fluid will then be used to prevent a collapse of the hole and cuttings will be returned to the landfall drill site. Excavation of exit pits will occur offshore within the surveyed corridor and outside of the Fire Island National Seashore boundary, as detailed in Section 3.3.3.

As further detailed in Appendix H, sediment transport modeling was completed for the installation of the SRWEC in both offshore and nearshore waters. After review of sediment modeling, the studies described in Sections 4.4.2 and 4.4.3, respectively, indicate that only short-term, limited impacts to fish and invertebrates are expected from suspended sediments; therefore, secondary effects on sea turtle prey availability are not expected. Furthermore, the study described in Appendix H indicates that TSS concentrations are predicted to return to ambient levels (<10 mg/L) within 0.4 hours from completing the installation of the SRWEC–OCS, and within 0.34 hours from completing the installation of the SRWEC–NYS. The TSS plume is predicted to be contained within the lower portion of the water column, approximately 9.8-ft (3.0-m) above the seafloor. These limited temporal effects over a relatively small area are not expected to interfere with sea turtle foraging success.

Noise

Noise associated with G&G surveys and SRWEC construction vessels and equipment is expected to have the same impacts on sea turtles, if not fewer, than previously described for construction of the SRWF. Clearing and installation of the SRWEC will include suction hopper dredging and jet or mechanical plowing, laying of the subsea cable, and cable protection; it will not require any impulsive sound activities such as pile driving. Additionally, as previously described, MEC/UXO clearance surveys may be used to identify and confirm targets for removal/disposal, as detailed in Section 3.3.3.4. However, avoidance is the preferred approach, and in the event that MEC/UXO clearance is required, removal methods will be selected based on consultations with a specialist and in coordination with the appropriate agencies. Additional residual risk management actions would be implemented to minimize impacts to sea turtles, as outlined in the environmental protection measures.

Although sea turtles are expected to perceive underwater noise from construction and installation of the SRWEC, impacts are not expected to be biologically significant to sea turtle populations. Individual sea turtles may temporarily vacate the area; however, they are expected to return once activity ceases. Additionally, given the Project location relative to major commercial shipping lanes, a significant disruption to the normal traffic pattern from construction and installation of the SRWEC is not anticipated.

CONSTRUCTION AND OPERATIONS PLAN

Site Characterization and Assessment of Impacts – Biological Resources

Discharges and Releases

The potential for sea turtle exposure and adverse impacts from routine and non-routine discharges and releases will be similar to that identified for the SRWF. Additionally, HDD at landfall will use a drilling fluid that consists of bentonite, drilling additives, and water. A barge or jack-up vessel may also be used to assist the drilling process, handle the pipe for pull in, and help transport the drilling fluids and mud for treatment, disposal and/or reuse. To minimize the potential risks for an inadvertent drilling fluid release, an Inadvertent Return Plan will be developed and implemented during construction. Refer to Section 3.3.3.3 for additional details regarding HDD installation and the use of drilling fluids.

Trash and Debris

The potential for sea turtle exposure and adverse impacts from routine and non-routine activities resulting in trash and debris will be similar to that identified for the SRWF. Depending on the type of trash or debris, sea turtles could become entangled or ingest foreign materials, causing injury or mortality. However, with proper waste management procedures, the potential for trash or debris to be inadvertently left overboard or introduced into the marine environment is not anticipated.

Vessel Traffic

The number of vessels required during installation of the SRWEC will be less than those required for the SRWF and more transient. Therefore, potential impacts associated with the increase in vessel traffic would be similar to, but lower than, previously described for the SRWF and therefore would be therefore minimal.

Lighting and Marking

Artificial lighting during construction of the SRWEC will be associated with navigational and deck lighting on vessels from dusk to dawn. Because of the limited area associated with the artificial lighting used on Project vessels relative to the surrounding unlit areas, the anticipated impacts to sea turtles will be similar to those from SRWF construction and are therefore expected to be temporary and minimal.

Operations and Maintenance

IPFs resulting in potential impacts on sea turtles in the SRWEC–NYS and OCS from the O&M of the Project are assessed below.

Seafloor Disturbance

Impacts to sea turtles from seafloor disturbance during O&M of the Project would be limited to the impacts expected on their benthic prey. Seafloor disturbing activities during O&M of the SRWEC–OCS and NYS are only expected during non-routine maintenance that may require uncovering and reburying the cables and/or the maintenance of the cable protection. These O&M activities are expected to result in similar impacts on benthic resources as those discussed for the SRWF and could therefore temporarily displace sea turtles due to decreased available forage. However, the extent of disturbance would be limited to specific areas along the SRWEC cable corridor centerline and the footprint of the SRWEC is relatively small when compared to the ample surrounding available benthic/prey habitat.

CONSTRUCTION AND OPERATIONS PLAN

Site Characterization and Assessment of Impacts – Biological Resources

Sediment Suspension and Deposition

Increases in sediment suspension and deposition during O&M of the SRWEC will primarily result from vessel anchoring and any maintenance activities that will require exposing the SRWEC. These activities are expected to be non-routine events and are not expected to occur with any regularity. Sediment suspension and deposition impacts resulting in increased turbidity from vessel activity during O&M of the SRWEC are therefore anticipated to be similar to vessel-related impacts described for the SRWEC construction phase (i.e., temporary and minimal), but less frequent and at a smaller scale throughout the life of the Project.

Noise

Direct impacts to sea turtles associated with noise during O&M of the SRWEC may result from support vessel and aircraft noise during routine and non-routine maintenance trips and as a result of G&G surveys.

Impulsive Sound—G&G Surveys

Short-term, localized impacts from HRG surveys during O&M may occur from the use of multi-beam echosounders, side-scan sonars, shallow penetration sub-bottom profilers, medium penetration sub-bottom profilers, and marine magnetometers. The indicative frequency of seafloor surveys during O&M is provided in Section 3.5, and site-specific verification of geophysical equipment sound sources has been conducted. The survey equipment to be employed will be equivalent to the equipment utilized during the HRG survey campaigns associated with Lease Area OCS–A 0500 conducted in 2016, 2017, 2018, 2019, and 2020 and with Lease Area OCS–A 0487 conducted in 2019 and 2020 (CSA Ocean Sciences Inc. 2020).

Non-impulsive Sound – Vessel Noise

Throughout the operational life of the SRWEC, Sunrise Wind expects to use a variety of vessels to support O&M, including SOVs with deployable work boats (daughter craft), CTVs, jack-up vessels, and cable laying vessels. Project vessels will undergo routine maintenance trips between potential ports in New York and Rhode Island and the SRWEC. Impacts from vessel use during O&M would be similar to those described for construction. Individual sea turtles may experience direct, short-term, reversible behavioral disruptions due to the incremental and transient contribution of O&M vessels.

Non-impulsive Sound – Aircraft

Sunrise Wind expects to use a hoist-equipped helicopter, and unmanned aircraft systems may also be used to support O&M. The type and number of vessels and helicopters will vary over the operational lifetime of the Project. Impacts from aircraft use during O&M would be similar to those described for construction.

CONSTRUCTION AND OPERATIONS PLAN

Site Characterization and Assessment of Impacts – Biological Resources

Electric and Magnetic Fields

Appropriate cable protection and/or burial depths are anticipated to reduce potential EMF resulting from cable operation to low levels. As detailed in Appendix J1, the DC magnetic fields above the SRWEC at peak loading (assessed for all permutations of four geographic directions and four cable configurations) were calculated to change Earth's ambient geomagnetic field by a maximum of ± 129 mG, decreasing to ± 41 mG a horizontal distance of 10 ft (3 m) from the cables, representing a change of less than 10 percent of the ambient geomagnetic field level of approximately 506 mG. Induced DC electric fields in an ocean current of 2 ft/s (60 cm/s) are dominated by the effects of Earth's ambient geomagnetic field and were calculated to be 0.38 mV/m directly above the SRWEC, decreasing to 0.033 mV/m at a distance of ± 10 -ft (3-m).

Impacts to sea turtles relating to the EMF emitted from the SRWEC are expected to be non-existent to minimal because of the low density of sea turtles present, and the relatively narrow corridor occupied by the SRWEC.

Discharges and Releases

Impacts to sea turtles from marine discharges and releases during O&M are expected to be similar to, but of lesser likelihood than during construction, as there will be fewer Project-related marine vessels during this phase, and regulatory requirements and preventative measures will still apply.

Trash and Debris

Impacts to sea turtles from disposal of trash and debris during O&M are expected to be similar to, but of lesser likelihood than during construction, as there will be fewer Project-related marine vessels during this phase, and regulatory requirements and preventative measures will still apply.

Vessel Traffic

The potential impacts of vessel traffic will be similar, but less than, those identified for O&M of the SRWF. In the unlikely event that a vessel strike occurs and results in injury or mortality, impacts would be considered minimal given the Threatened and Endangered status of these populations countered by their overall resilience to population-level impacts. Due to the intermittent vessel activity during O&M and the implementation of vessel strike avoidance measures and environmental protection measures described below, vessel traffic is expected to be a minimal impact on sea turtles.

Visible Infrastructure

As previously described, cable protection measures such as concrete mattresses may be placed in select areas along the SRWEC. Cable protection measures would not extend into the water column and would be comparable to existing areas where boulders or other hard bottom habitat are present. The introduction of hard bottom habitat along the corridor may have a beneficial long-term impact on benthic species/sea turtle prey. Further discussion on habitat conversion was previously described for O&M of the SRWF.

CONSTRUCTION AND OPERATIONS PLAN

Site Characterization and Assessment of Impacts – Biological Resources

Onshore Facilities

After landfall on Fire Island, the Onshore Transmission Cable will cross the ICW via HDD to a paved parking lot within the Smith Point Marina along East Concourse Drive. As previously described, Kemp's ridley, green, and loggerhead sea turtles may be present within Great South Bay and the ICW due to available foraging habitat. It is unlikely that any sea turtles would be encountered on land in the Project Area.

Construction

Sea turtles are not expected to be notably impacted by construction of the Onshore Facilities. As previously described, HDD will occur onshore within a designated Landfall Work Area. Prior to Landfall HDD activities, pipeline stringing will need to occur, which will consist of laying the pipeline on the beach, adjacent to the water. As of now, the Landfall HDD activity is expected to occur from October through March, during which time pipeline will be sitting on the beach. As sea turtles are not expected to nest on nearby beaches, no impacts are expected from this activity. Activities associated with the temporary floating pier may introduce low levels of in-air and underwater noise to the ICW; however, any resulting behavioral effects are expected to be localized and short-term.

Although no impacts from discharges and releases are anticipated, spills or accidental releases of fuels, lubricants, or hydraulic fluids could occur during use of trenchless installation and duct bank installation methods, and installation of the Onshore Transmission Cable. An SPCC Plan will be developed, and any discharges or release will be governed by New York State regulations. Additionally, where HDD is utilized, an Inadvertent Return Plan will be prepared and implemented to minimize the potential risks associated with release of drilling fluids. Any unanticipated discharges or releases within the Onshore Facilities during construction are expected to result in minimal, temporary impacts; activities are heavily regulated, and discharges and releases are considered accidental events that are unlikely to occur.

Additionally, good housekeeping practices will be implemented to minimize trash and debris in onshore work areas. These practices will include orderly storage of tools, equipment, and materials as well as proper waste collection, storage, and disposal to keep work areas clean and minimize potential environmental impacts. All trash and debris returned to shore from offshore vessels will be properly disposed of or recycled at licensed waste management and/or recycling facilities. Disposal of any solid waste or debris in the water will be prohibited. With proper waste management procedures, the potential for trash or debris to be inadvertently introduced onto an onshore area is unlikely.

Operations and Maintenance

IPFs resulting in potential impacts to sea turtles during O&M of the Onshore Facilities would be largely limited to EMF, and are discussed below along with the potential impact for discharges and releases, and trash and debris. In the event that the subsea cables required maintenance, impacts to sea turtles in the ICW would be temporary and minimal, and similar to those described for the SRWEC (including temporary seafloor disturbance, sediment suspension and deposition, vessel traffic, discharges and releases, and trash and debris).

CONSTRUCTION AND OPERATIONS PLAN

Site Characterization and Assessment of Impacts – Biological Resources

Electric and Magnetic Fields

The ICW is part of a partially enclosed waterbody with less natural flushing or tidal activity as compared with the open ocean and nearshore waters previously described. Additionally, where the Onshore Transmission Cable will cross, the water depths are less than 10 ft (3 m; NOAA n.d.). As with nearshore waters, sea turtles are most likely to encounter EMF effects from the subsea cable if feeding on benthic organisms or resting on the seafloor above the cable. However, only very low or no EMF levels are expected to be detected at the ICW crossing, depending on exact burial depth at time of construction. The footprint of the subsea cable within the ICW is quite small when compared to the waterway as a whole. Additionally, sea turtles are more likely to be utilizing the eelgrass beds in the larger portion of Great South Bay to the west as opposed to the more trafficked and narrowed crossing of the Smith Point Bridge where the subsea cables will be installed.

4.4.5.3 Proposed Environmental Protection Measures

A protected species mitigation and monitoring plan will incorporate findings from the underwater acoustic assessment; supplement existing data gaps; allow for an evaluation of changes caused by offshore infrastructure within the context of larger regional shifts in species distributions; and describe the avoidance, minimization, and mitigation measures and approach taken by Sunrise Wind. Long-term regional monitoring efforts will also be discussed in the plan. Sunrise Wind will work further with BOEM and NOAA Fisheries to refine an adaptive mitigation approach that optimizes flexibility while appropriately mitigating potential impacts to marine mammals, including:

- Sunrise Wind will comply with the current NOAA Fisheries speed restrictions at the time of Project activities. These measures for marine mammals will aid in minimizing impacts to sea turtles as well.
- Sunrise Wind will require operational AIS on all vessels associated with the construction, operation, and decommissioning of the Project, pursuant to USCG and AIS carriage requirements. AIS will be used to monitor the number of vessels and traffic patterns for analysis and compliance with vessel speed requirements.
- Sunrise Wind will adhere to vessel strike avoidance measures as required by BOEM and NOAA Fisheries.
- To the extent feasible, the SRWEC and IAC will typically target a burial depth of 3 to 7 ft (1 to 2 m). The target burial depth will be determined based on an assessment of seabed conditions, seabed mobility, the risk of interaction with external hazards such as fishing gear and vessel anchors, and a site-specific Cable Burial Risk Assessment.
- For all MEC/UXO clearance methods, safety measures such as the use of guard vessels, enforcement of safety zones, and others will be identified in consultation with a MEC/UXO specialist and the appropriate agencies and implemented as appropriate. Residual risk management actions will be implemented, including developing an emergency response plan, conducting MEC/UXO-specific safety briefings, and retaining an on-call MEC/UXO consultant.

CONSTRUCTION AND OPERATIONS PLAN

Site Characterization and Assessment of Impacts – Biological Resources

- Plow cables/umbilicals will be under constant tension, and in this taut condition, are not expected to represent an entanglement risk.
- Sunrise Wind will require all construction and O&M vessels to comply with applicable International Convention for the Prevention of Pollution from Ships (IMO MARPOL), federal (USCG and EPA), and state regulations and standards for the management, treatment, discharge, and disposal of onboard solid and liquid wastes and the prevention and control of spills and discharges.
- Sunrise Wind will provide training for personnel onboard Project vessels, including PSO monitoring and reporting procedures, to emphasize individual responsibility for sea turtle awareness and protection.
- All crew supporting the Project will undergo marine debris awareness training, and such training will include use of the data and educational resources available through the NOAA Fisheries Marine Debris Program.
- Sunrise Wind completed a comprehensive underwater acoustic assessment to include modeling in support of evaluation of potential impacts due to noise generated during construction of the Project. The assessment followed NOAA Fisheries' Greater Atlantic Regional Fisheries Office tool for assessing the potential effects to ESA-listed fish and sea turtles exposed to elevated levels of underwater sound from pile driving. Potential zones of influence described in this assessment will be reflected in the proposed mitigation measures in the mitigation and monitoring plan.
- Additionally, the Project will implement the following mitigation measures, pursuant to ongoing dialogue with BOEM and NOAA Fisheries. Each of these methods and tools has been successfully applied by Orsted, Sunrise Wind, and/or its affiliates in support of geophysical surveys and/or the construction and operation of offshore wind projects across the globe. A protected species mitigation and monitoring plan will describe these measures and will be included within the LOA; these measures will also aid in minimizing impacts to sea turtles:
 - Exclusion and monitoring zones
 - Ramp-up/soft-start procedures
 - Shutdown procedures (if technically feasible)
 - Qualified and NOAA Fisheries-approved protected species observers (PSOs)
 - Noise attenuation technologies
 - Passive Acoustic Monitoring systems (fixed and mobile)
 - Reduced visibility monitoring tools/technologies (e.g., night vision, infrared and/or thermal cameras)
 - Adaptive vessel speed reductions
 - Utilization of software to share visual and acoustic detection data between platforms in real time.

CONSTRUCTION AND OPERATIONS PLAN

Site Characterization and Assessment of Impacts – Biological Resources

- Sunrise Wind will advise all construction and O&M vessels to comply with USCG and EPA regulations that require operators to develop waste management plans, post informational placards, manifest trash sent to shore, and use special precautions such as covering outside trash bins to prevent accidental loss of solid materials.

4.4.6 Avian Species

This section describes the affected environment and potential effects from the construction and operation of the Project as they relate to avian species. The description of the affected environment and assessment of potential impacts to avian species were developed by reviewing current public data sources related to birds, including state and federal agency databases, online data portals and mapping databases, published scientific literature relating to relevant avian data, and correspondence and consultation with state and federal agencies. The primary agency sources used include a NYNHP Project-specific inquiry response letter dated March 27, 2020, and a USFWS IPaC database inquiry response letter dated March 11, 2020. Online data portal and mapping databases used include NYSERDA Remote Marine and Onshore Technology aerial avian survey data (Normandeau and APEM 2019), bird abundance models developed by NOAA National Centers for Coastal Ocean Science and prepared by the Marine-life Data and Analysis Team (MDAT; Curtice et al. 2019). Primary empirical data sources include the following regional offshore avian studies that overlap with the Project Area: Bay State Wind ship-based surveys (Bay State Wind 2019), Massachusetts Clean Energy Center (MassCEC) aerial surveys (Veit and Perkins 2014; Veit et al. 2016), OSAMP ship-based surveys and aerial surveys (Paton et al. 2010; Winiarski et al. 2012), and regional tern and shorebird telemetry surveys (Loring et al. 2017a,b, 2018, 2019) (Figure 4.4.6-1). Primary empirical onshore data sources include results of 2018 colonial waterbird and beach nesting bird surveys (Jennings 2018) and the New York State Breeding Bird Atlas 2000 to 2005 dataset (New York State Breeding Bird Atlas 2007).

This page intentionally left blank

V:\1956\active_Task Owner and other Non-BC1956_Jobs\2028113199\03_data\gis_cad\gis\mxd\COP\2028113199_4.4.6-1_AvianStudies.mxd Revised: 2021-05-07 By: gcarpenter

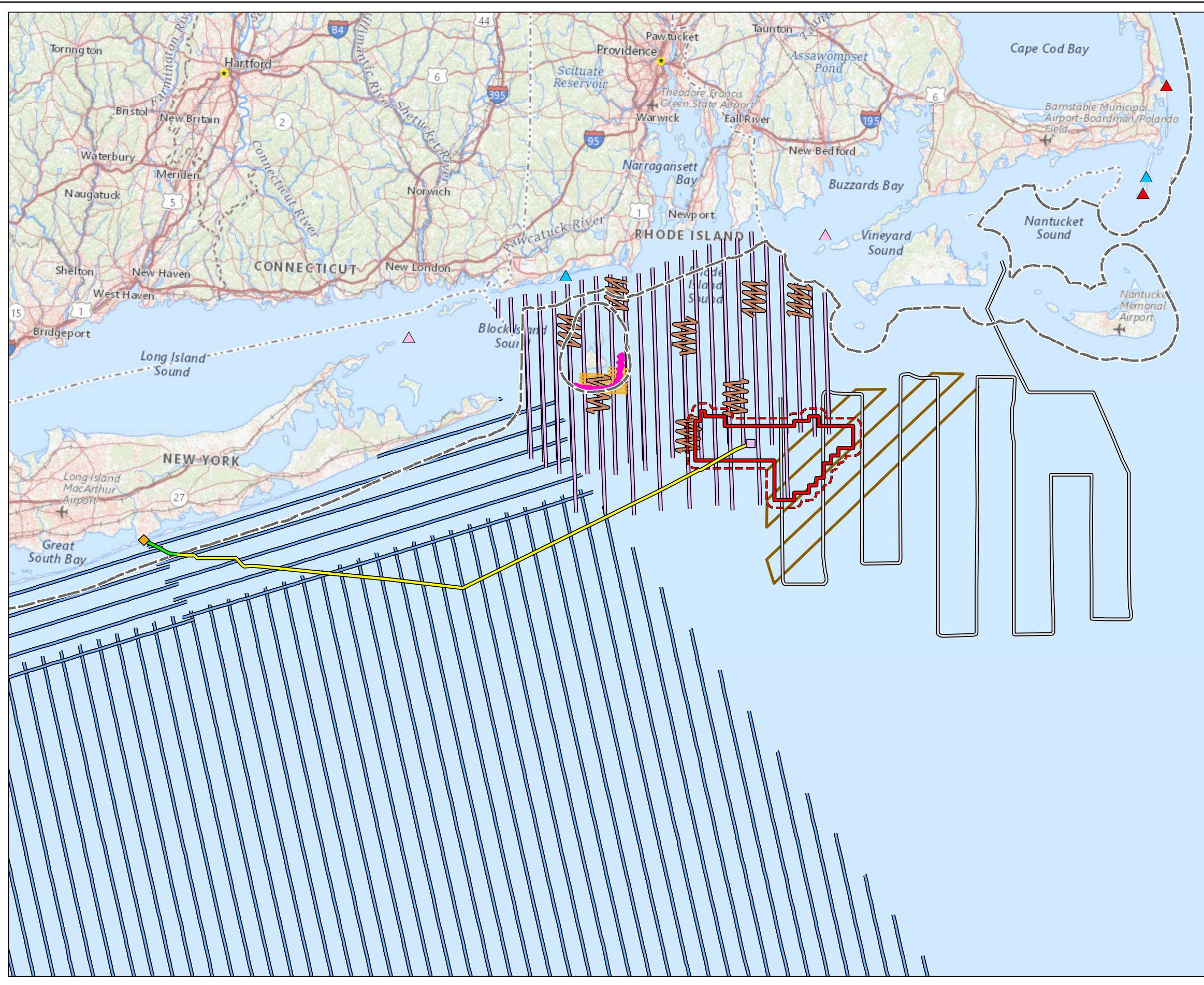

Figure 4.4.6-1
Locations of Relevant
Regional Bird Surveys

**Sunrise
Wind**

Powered by
**Ørsted &
Eversource**

Legend

- Sunrise Wind Farm (SRWF)
- 1-nm from SRWF
- Offshore Converter Station (OCS-DC)
- SRWEC Landfall Location
- Sunrise Wind Export Cable (SRWEC-OCS)
- Sunrise Wind Export Cable (SRWEC-NYS)
- 3-nm State Waters Boundary
- BWF Offshore Pre and Post Construction Boat-based Avian Surveys
- BWF Offshore Aerial HD Video Surveys
- OSAMP Ship Surveys (July 2009–August 2010)
- OSAMP Aerial Surveys (December 2009–July 2012)
- NYSERDA OPA Digital Aerial Surveys (2016–2019)
- MassCEC Aerial Surveys (November 2011–January 2015)
- Bay State Wind Avian Ship Surveys (May 2017–October 2017)
- BOEM Telemetry Studies**
- Piping Plover Capture Location
- Roseate Tern Capture Location
- Red Knot Capture Location

Sources

Base Map: USGS The National Map

Date	12/18/2020 Revised: 6/1/2021
Project Number	2028113199
Prepared By	GC
Reviewed By	LJ

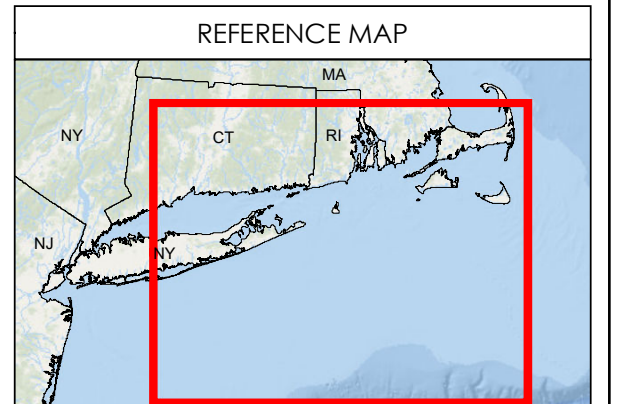
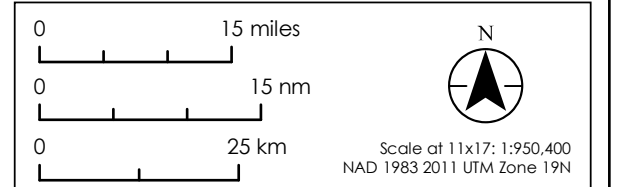

This page intentionally left blank

CONSTRUCTION AND OPERATIONS PLAN

Site Characterization and Assessment of Impacts – Biological Resources

Specific requirements for addressing avian use and species occurrence information, including determining spatial and temporal distribution and abundance of avian species, within this COP are described in *BOEM's Guidelines for Avian Survey Information*, pursuant to 30 CFR Part 585 Subpart F (BOEM 2016). BOEM will be the lead federal agency during the review of the SRWF under the NEPA (42 USC 4321 *et seq.*) for environmental effects and benefits. Section 7 of the ESA of 1973 (16 U.S.C. § 1531 *et seq.*) is the mechanism by which federal agencies ensure the actions they take, including those they fund or authorize, do not jeopardize the existence of any listed species. Federal agencies consult with the USFWS to assess how proposed actions may affect federally endangered or threatened species and/or their designated critical habitat. Brief descriptions of the avian species that may occur in the different portions of the Project Area are provided below, followed by an evaluation of potential Project-related impacts. More detailed information from the available literature concerning avian species are presented in Appendix P – *Avian and Bat Risk Assessment*.

4.4.6.1 Affected Environment

Regional Overview

Several different avian species groups may occur within the offshore and onshore portions of the Project Area and surrounding region over the course of a year, including marine birds (petrels and shearwaters, loons and grebes, gannets, cormorants, sea ducks, skuas and jaegers, kittiwakes and gulls, terns and skimmers, and auks [alcids]), coastal birds (shorebirds, waterfowl [geese, bay ducks, dabblers], and wading birds), and land birds (raptors, passerines and woodpeckers, and game birds). Table 4.4.6-1 lists taxonomic groups that may occur within offshore and onshore Project Areas, based on observations made during regional avian studies for which survey areas overlapped with the Project.

Table 4.4.6-1 Timing, Distribution, and Status of Avian Species Groups Likely to Occur within or Proximate to the Project Area

Avian Group ^{a/ b/}	Seasonal Use	Primary Seasons	Primary Location ^{c/}	General Abundance ^{d/}
Marine birds				
petrels and shearwaters	summer, fall	summer	offshore	common
loons	migrant, winter resident	fall, winter	offshore, nearshore	common
grebes	migrant, winter resident	winter	nearshore	occasional
gannets	migrant, winter resident	spring, fall, winter	offshore	common
cormorants	summer breeder; winter resident	summer, fall, winter	nearshore	common (exc. great cormorant, occasional in winter)
sea ducks	winter resident	winter	offshore, nearshore	common
skuas and jaegers	migrant, winter resident	fall, winter	offshore	uncommon to rare
kittiwakes	winter resident	winter	offshore	occasional
auks	winter resident	winter	offshore	uncommon

CONSTRUCTION AND OPERATIONS PLAN

Site Characterization and Assessment of Impacts – Biological Resources

Avian Group ^{a/ b/}	Seasonal Use	Primary Seasons	Primary Location ^{c/}	General Abundance ^{d/}
Coastal birds				
geese, bay ducks, dabblers	migrant, winter resident	fall, winter	offshore, nearshore	common
shorebirds	breeding, migrant	summer, fall	nearshore, onshore	common
wading birds	breeding, migrant	spring, summer	nearshore, onshore	common
gulls	breeding, migrant, winter resident	year round	offshore, nearshore, onshore	abundant
terns and skimmers	breeding, migrant	summer, fall	nearshore, onshore	common
Land birds				
raptors, passerines and woodpeckers, and game birds	breeding, migrant, winter resident	spring, summer	onshore (and nearshore and rarely offshore during migration)	Common
Sources: Paton et al. 2010; Winiarski et al. 2012; Viet and Perkins 2014; Veit et al. 2016; Bay State 2019; Normandeau and APEM 2019.				
NOTES:				
^{a/} For full lists of species expected within these groups by Project Area location see Tables 4.4.6-2 and 4.4.6-3.				
^{b/} There are some bird groups that can fit into both marine and coastal categories, for example loons, cormorants, gulls, and terns can utilize both marine and coastal environments.				
^{c/} Offshore = in waters > 3 nm (5.6 km) from the shoreline, may occur within the SRWEC–OCS or SRWF; Nearshore = waters < 3 nm (5.6 km) to the shoreline, may occur within the SRWEC–NYS as it approaches land; Onshore = on land, may occur at the shoreline or further inland.				
^{d/} Abundant = occurring regularly in greater numbers relative to other species during given season(s); Common = occurring regularly during given season(s); Occasional = occurring infrequently during given season(s) and in relatively small numbers; Uncommon = occurring very infrequently in given season(s), may occur sporadically in small numbers; Rare = very seldom occurring.				

The diversity of marine bird species that use the Project Area and surrounding region is due in part to its location within the Mid-Atlantic Bight, a region where species that breed in both the Northern and Southern hemispheres overlap. The Mid-Atlantic Bight is an oceanic region that reaches from Cape Cod, MA, to Cape Hatteras, NC, and is characterized by a broad expanse of gently sloping, sandy-bottomed continental shelf. Within this region, the shelf extends up to 93 mi (80.8 nm, 149.7 km) offshore, where the waters reach about 650 ft (198 m) deep. Beyond the shelf edge, the continental slope descends rapidly to around approximately 10,000 ft (3,048 m). Most of the shallow coastal region is bathed in cool Arctic waters brought south by the Labrador Current. At the southern end of this region, around Cape Hatteras, these cool waters collide with the warmer waters of the Gulf Stream.

The region exhibits a dynamic seasonal cycle in temperature, with sea surface temperatures spanning 37 °F to 86 °F (2.7–30.0 °C; Williams et al. 2015). The variety of physical, chemical, and biological conditions within this region dictate the distribution and activity of marine biological resources, both seasonally and annually. Water depth is one of the primary physical features affecting avian species distribution, as this habitat characteristic limits where different species can successfully access food resources.

CONSTRUCTION AND OPERATIONS PLAN

Site Characterization and Assessment of Impacts – Biological Resources

However, other factors such as substrate, water temperature, salinity, and currents all affect resource availability and, consequently, species distribution and abundance. Based on MDAT's models, avian abundance (for all seasons and species combined) is generally low within the offshore waters within and surrounding the SRWF, and increases closer to shore and to the east of the Project Area where there are productive foraging areas (Figure 4.4.6-2; Curtice et al. 2019; NYSERDA 2017a).

This page intentionally left blank

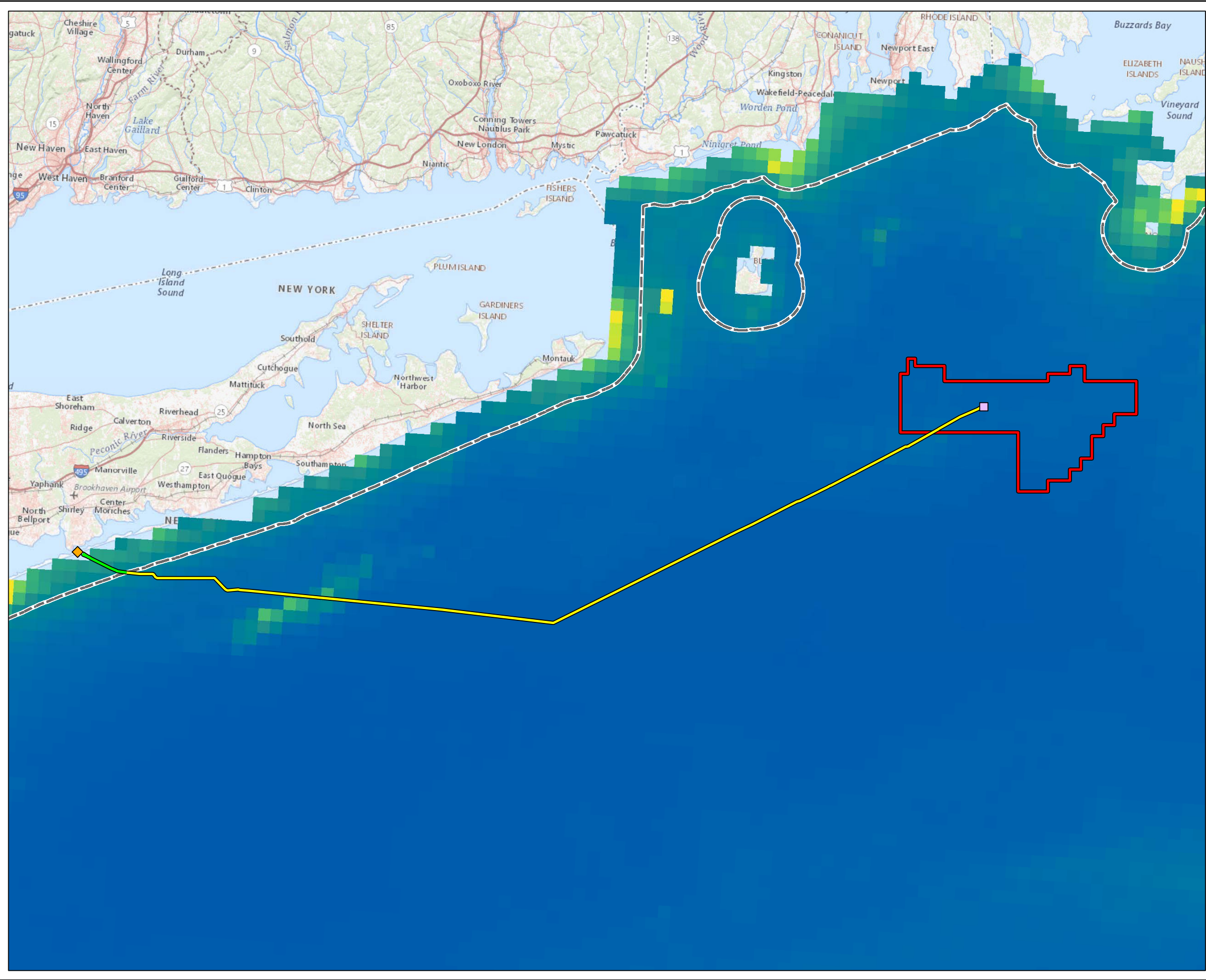

Figure 4.4.6-2
Bird Abundance Estimates
(All Species) from the MDAT Models

Sunrise Wind | Powered by **Ørsted & Eversource**

Legend

- Sunrise Wind Farm (SRWF)
- Offshore Converter Station (OCS-DC)
- ◆ SRWEC Landfall Location
- Sunrise Wind Export Cable (SRWEC-OCS)
- Sunrise Wind Export Cable (SRWEC-NYS)
- 3-nm State Waters Boundary

Total Bird Abundance (see note)

Note
 For all species together and for each group of species, the total bird abundance is total relative number of individuals per grid 2-km x 2-km cell normalized by the mean of each grid cell. The result is the total predicted relative density in that cell.

Sources
 Total Bird Abundance data developed by NOAA National Centers for Coastal Ocean Science (NCCOS), prepared by the Marine-life Data and Analysis Team (MDAT).

Date	12/18/2020 Revised: 6/1/2021
Project Number	2028113199
Prepared By	GC
Reviewed By	LJ

0 10 miles

0 8 nm

0 16 km

N

Scale at 11x17: 1:633,600
NAD 1983 2011 UTM Zone 19N

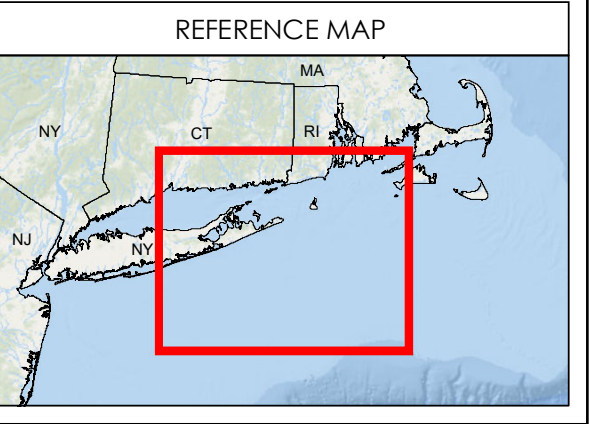

This page intentionally left blank

CONSTRUCTION AND OPERATIONS PLAN

Site Characterization and Assessment of Impacts – Biological Resources

Many marine birds make annual migrations up and down the eastern seaboard (e.g., gannets, loons, and sea ducks), taking them directly through the region in spring and fall. This results in a complex ecosystem where the community composition shifts regularly, and temporal and geographic patterns are highly variable. The region supports large populations of birds in the summer, some of which breed in the area, such as coastal gulls and terns (Jennings 2018). Other summer residents, such as shearwaters and storm-petrels, visit from the Southern Hemisphere (where they breed during the austral summer) (Drucker et al. 2020; Carboneras et al. 2020). In the fall, many of the summer residents leave the area and migrate south to warmer regions and are replaced by species that breed further north and winter in the region (Bordage and Savard 2020; Roberston and Savard 2020).

Coastal birds that use the Project Area and surrounding region include shorebirds, waterfowl, and wading birds. Most shorebirds breed and forage along coastal beaches and only occur offshore during migration. Waterfowl such as geese, bay ducks, and dabbling ducks and wading birds such as herons and egrets typically utilize inland, coastal, and wetland habitats and only occur offshore during migration.

Land birds that use the Project Area and surrounding region include songbirds and raptors. Songbirds breed in a variety of upland and coastal habitats and are only present offshore during migration. Raptors, including accipiters, buteos, and harriers, may breed and forage in upland habitats, and pass through the area during migration. Falcons, osprey, and eagles may utilize coastal areas to breed, forage, and migrate.

Bald eagles (*Haliaeetus leucocephalus*) are protected under the *Bald and Golden Eagle Protection Act* of 1940 (as amended in 1962; BGEPA) and have a year-round presence in the region (NYSDEC 2015b). The bald eagle is a large raptor that is broadly distributed and generally found nesting in association with water (lakes, rivers, bays) in both freshwater and marine habitats (Buehler 2000). The wing morphology of bald eagles and their reliance on thermal updrafts, generally dissuades long-distance movements in offshore settings (Kerlinger 1985). Bald eagles are present year-round in the region and have been slowly increasing in numbers over the last 30 years. Bald eagles have recently returned to Long Island (NYNHP 2020b) and are known to breed throughout New York, with the exception of the New York City area, and a portion of central New York (NYSDEC 2015b).

Critical Habitat is defined under the ESA as specific geographic areas that contain features essential to the conservation of an RTE species and that may require special management and protection (USFWS 2020). There is no designated Critical Habitat for any ESA-listed species in area occupied by the Onshore Facilities (USFWS 2020). However, three species listed under the ESA have been identified by the USFWS as occurring in the region: piping plover (*Charadrius melodus*; federally threatened), red knot (*Calidris canutus rufa*; federally threatened), and roseate tern (*Sterna dougallii*; federally endangered).

CONSTRUCTION AND OPERATIONS PLAN

Site Characterization and Assessment of Impacts – Biological Resources

Piping plovers nest on sandy beaches in the region, and both piping plovers and red knots pass through the region during spring and fall migration. Roseate terns also migrate through the region on their way to coastal breeding sites in New England and Atlantic Canada, and breed on small islands as far south as the Long Island area (NYSDEC 2015a). One species proposed for listing under the ESA, the black-capped petrel (*Pterodroma hasitata*), could potentially occur in the region, although this species is generally associated with waters deeper than the nearshore waters utilized by the three listed species (USFWS 2019a). The federally protected species identified above have the potential to occur in any portion of the Project Area; therefore, short summaries of their relevant life history information are provided below.

Piping Plover

The piping plover is a small shorebird that nests on beaches along the Atlantic coast, around the Great Lakes, and in the Midwestern plains (Elliott-Smith and Haig 2004) and winters in the coastal southeastern US and the Caribbean (Elliott-Smith and Haig 2004; USFWS 2009; BOEM 2014). The Atlantic subspecies (*C. m. melodus*) is listed as Threatened under the ESA and is heavily managed to promote population recovery (Elliott-Smith and Haig 2004). Piping plovers are listed as State Endangered in New York (NYSDEC 2015c) and State Threatened in Massachusetts (MDFW 2015a). They typically breed and nest on sandy beaches and spoil banks of coastal New York, Rhode Island, and the Vineyards, as well as coastal beaches along the East Coast. Piping plover are present in the region from March through September and nest on beaches on Long Island from April through August (NYSDEC 2015c). Results of the 2018 Long Island colonial waterbird surveys found 82 active piping plover breeding sites and 404 breeding pairs along the coast and barrier islands. Twenty-five breeding pairs occurred at Smith Point County Park, in the vicinity of the landfall location (Jennings 2018). The piping plover has also been documented as nesting within the Great South Bay area (NYSERDA 2017b). Site assessments conducted by the USACE from 2009 to 2013 documented an average of 15 nesting pairs per year between Fire Island Inlet, approximately 19 mi (17 nm, 31 km) west of the landfall location, to Moriches Inlet, approximately 6 mi (5 nm, 10 km) east of the landfall location (USACE 2014).

While migration pathways are known to occur along the East Coast, this species may also fly over the SRWF and SRWEC (and other WEAs in federal waters) during migration (Loring et al. 2019); however, migratory flights over offshore waters are infrequent (NYSERDA 2017a, Burger et al. 2011).

Red Knot

The red knot is a medium-sized shorebird that undertakes one of the longest non-stop migratory flights of up to 5,000 mi (4,344.9 nm, 8,046.7 km; Baker et al. 2013). This species breeds in the High Arctic and winters in the southeastern US, Caribbean, Northern Brazil, and Tierra del Fuego–Argentina (Baker et al. 2013). The Atlantic flyway subspecies (*C. c. rufa*) is listed as Threatened under the ESA, due to a significant decline (approximately 70 percent from 1981 to 2012) to less than 30,000 individuals (Burger et al. 2011; Baker et al. 2013; USFWS 2019b). The red knot is listed as State Threatened in New York (NYSDEC 2015d) and State Threatened in Massachusetts (MDFW 2020). The red knot may be present in New York, Massachusetts, and Rhode Island, as well as other coastal habitats along the East Coast during migratory periods (NYSERDA 2017a). The subspecies' primary stopover during spring migration is Delaware Bay (Niles et al. 2009). Red knots may fly over the SRWF and SRWEC during migration (Loring et al. 2018).

CONSTRUCTION AND OPERATIONS PLAN

Site Characterization and Assessment of Impacts – Biological Resources

Red knot may also occur in Long Island along salt meadows and mudflats of the South Shore (NYSDEC 2015d; Burger et al. 2012). Red knots may stop over during migration to forage in intertidal habitats near the cable landfall location at Smith Point County Park.

Roseate Tern

The roseate tern is a small seabird that breeds colonially on coastal islands of the northeastern US and Atlantic Canada and winters in South America, primarily eastern Brazil (USFWS 2010; Nisbet et al. 2014). The Northwest Atlantic population is listed as Endangered under the ESA, State Endangered in New York (NYSDEC 2015a), and State Endangered in Massachusetts (MDFW 2015b). Roseate tern is listed as State Historical in Rhode Island, and the last documented occurrence in Rhode Island was in 1979 (RINHP 2006). Roseate terns generally migrate over the Atlantic OCS between their northwest Atlantic breeding colonies and wintering areas (Loring et al. 2019). Following breeding, they move to coastal staging areas and forage up to 10 mi (8.7 nm, 16.1 km) from the coast, though most foraging activity occurs much closer to shore (Burger et al. 2011). Loring et al. (2019) indicated that as roseate terns occur over federal waters (beyond 3.5 mi [3 nm, 5.6 km] from shore), roseate terns may be exposed to potential WEAs in federal waters during both breeding and post-breeding dispersal periods. Ninety percent of the roseate tern population breeds in the Cape Cod-Long Island area on rocky coastal islands, outer beaches, or salt marsh islands with protective vegetation to conceal nests (Veit and Petersen 1993; USFWS 2001). On Long Island, the vast majority of pairs nest on Great Gull Island, which is located off the eastern end of the North Fork of Long Island, approximately 45 mi (39 nm, 72 km) from SRWF (NYSDEC 2015a; Jennings 2018; NYSERDA 2017a). Roseate terns have historically nested in the vicinity of the barrier island at Fire Island National Seashore (FINS) (NYSERDA 2017b) as well as Cedar Beach, which is west of FINS (NPS 2018; Peters 2008), and may potentially breed near the cable landfall location at Smith Point County Park (NPS 2018; Peters 2008). Roseate terns may forage over adjacent shallow waters and/or loaf in the area; Fire Island Inlet has provided important foraging habitat (Peters 2008). Roseate terns may fly over the SRWF and SRWEC (and other WEAs in federal waters) during migration (Nisbet 1984; Mostello et al. 2014; Loring et al. 2019).

Black-Capped Petrel

The black-capped petrel is a pelagic seabird that breeds in small colonies on remote forested mountainsides of Caribbean islands (Simons et al. 2013). During their breeding season (January–June), black-capped petrels travel long distances to forage over the deeper waters (~650–6,500 ft [~198–1,981 m]) of the southwestern North Atlantic, the Caribbean basin, and the southern Gulf of Mexico (Simons et al. 2013). Outside the breeding season, they regularly spend time in US waters, along the shelf edge of the South Atlantic Bight, commonly as far north as Cape Hatteras and occasionally beyond (Jodice et al. 2015), but are rarely seen offshore of Long Island, Massachusetts, or Rhode Island. Black-capped petrels may rarely occur within the SRWF but are not expected to occur near the cable landfall location.

CONSTRUCTION AND OPERATIONS PLAN

Site Characterization and Assessment of Impacts – Biological Resources

Sunrise Wind Farm

Offshore waters provide foraging habitat for seabirds such as petrels, shearwaters, gannets, cormorants, sea ducks, gulls, terns, and skimmers and migratory transit airspace for migratory birds such as passerines and, more rarely, raptors such as falcons. Due to the SRWF's distance from shore, it is generally beyond the normal migration range of most breeding terrestrial or coastal bird species, though some weather events may occasionally push migrants such as passerines further offshore. Large bodied raptors that commonly soar on thermals as a flight strategy during migration—such as eagles, northern goshawk (*Accipiter gentilis*), species in the genus *buteo*, and large owls—are rarely observed offshore; smaller bodied raptors with relatively more active, flapping flight such as northern harrier (*Circus hudsonius*), sharp-shinned hawk (*Accipiter striatus*), northern saw-whet owl (*Aegolius acadicus*), and merlin (*Falco columbarius*) are regularly observed on islands offshore; and peregrine falcon (*Falco peregrinus*) have been documented hundreds of miles offshore (Voous 1961; McGrady et al. 2006; Johnson et al. 2011a; DeSorbo et al. 2012, 2015, 2018, as cited by BRI 2019). Therefore, falcons such as peregrine falcon and merlin may on occasion travel as far offshore as the SRWF.

The SRWF will be in water depths of 135 to 190 ft (41 to 58 m) MSL (115 to 203 ft [35 to 62 m MLLW]), and located 18.9 mi (16.4 nm, 30.4 km) south of Martha's Vineyard, MA, approximately 30.5 mi (26.5 nm, 49.1 km) east of Montauk, NY, and 16.7 mi (14.5 nm, 26.9 km) from Block Island, RI. There are no shallow banks in the SRWF; however, fish, crustaceans, and other zooplankton are available as prey base for seabirds at different depths. The seafloor in the SRWF consists of a mix of sand, gravel, and mud sediments (Appendix M – *Benthic Resources Characterization and Habitat Mapping Reports*).

Table 4.4.6-2 lists species that may occur within the SRWF, based on observations made during the Bay State Wind and MassCEC avian surveys, which overlapped with the SRWF (Veit et al. 2016; Bay State Wind 2019). Though not observed during these two regional surveys, regional telemetry studies conducted from 2014 to 2017 indicate that piping plover, red knot, roseate tern, and common tern (*Sterna hirundo*, state-threatened) have the potential to occur over the SRWF while migrating (Loring et al. 2018, 2019). Appendix P provides the mean annual and seasonal densities, both in tabular and map form, for marine birds in the SRWF based on the MDA models.

CONSTRUCTION AND OPERATIONS PLAN

Site Characterization and Assessment of Impacts – Biological Resources

Table 4.4.6-2 Timing, Distribution, and Status of Avian Species Observed During Regional Surveys that are Likely to Occur within or Proximate to the SRWF

Taxonomic Group	Species	Regional Use	Season Offshore	General Abundance Offshore	New York Status ^{a/}
Loons					
common loon	<i>Gavia immer</i>	migrant, winter resident	fall, winter	common	SSC, SGCN
red-throated loon	<i>Gavia stellata</i>	migrant, winter resident	fall, winter	common	BCC
Grebes					
red-necked grebe	<i>Podiceps grisegena</i>	migrant, winter resident	winter	occasional	NL
Petrels and Shearwaters					
Cory's shearwater	<i>Calonectris diomedea</i>	migrant	summer, fall	common	SGCN
great shearwater	<i>Puffinus gravis</i>	migrant	summer, summer	common	BCC
Leach's storm-petrel	<i>Oceanodroma leucorhoa</i>	migrant	summer, fall	uncommon	NL
manx shearwater	<i>Puffinus puffinus</i>	migrant	summer, fall	uncommon	NL
northern fulmar	<i>Fulmarus glacialis</i>	winter resident	winter	uncommon	NL
sooty shearwater	<i>Puffinus griseus</i>	migrant	summer, fall	uncommon	NL
Wilson's storm-petrel	<i>Oceanites oceanicus</i>	migrant	summer, fall	common	NL
Gannets					
northern gannet	<i>Morus bassanus</i>	migrant, winter resident	spring, fall, winter	common	NL
Cormorants					
double-crested cormorant	<i>Phalacrocorax auritus</i>	breeding, winter resident	year-round	occasional	NL
Sea Ducks					
black scoter	<i>Melanitta americana</i>	winter resident	winter	common	SGCN
common eider	<i>Somateria mollissima</i>	winter resident	winter	common	SGCN
surf scoter	<i>Melanitta perspicillata</i>	winter resident	winter	common	SGCN
white-winged scoter	<i>Melanitta fusca</i>	winter resident	winter	common	SGCN

CONSTRUCTION AND OPERATIONS PLAN

Site Characterization and Assessment of Impacts – Biological Resources

Taxonomic Group	Species	Regional Use	Season Offshore	General Abundance Offshore	New York Status ^{a/}
long-tailed duck	<i>Clangula hyemalis</i>	winter resident	winter	common	SGCN
red-breasted merganser	<i>Mergus serrator</i>	winter resident	winter	common	NL
Shorebirds					
red phalarope	<i>Phalaropus fulicarius</i>	migrant	spring, fall	uncommon	NL
red-necked phalarope	<i>Phalaropus lobatus</i>	migrant	spring, fall	common	NL
Gulls					
black-legged kittiwake	<i>Rissa tridactyla</i>	winter resident	winter	common	NL
great black-backed gull	<i>Larus marinus</i>	breeding, migrant, winter resident	spring, summer	abundant	NL
herring gull	<i>Larus argentatus</i>	breeding, migrant, winter resident	spring, summer	abundant	NL
laughing gull	<i>Leucophaeus atricilla</i>	breeding, migrant, winter resident	spring, summer	abundant	SGCN
Terns and Skimmers					
common tern	<i>Sterna hirundo</i>	migrant	spring, summer, fall	occasional	ST, SGCN
roseate tern	<i>Sterna dougallii</i>	breeding, migrant	spring, summer, fall	uncommon	FE, SE
Auks					
common murre	<i>Uria aalge</i>	winter resident	winter	uncommon	NL
dovekie	<i>Alle</i>	winter resident	winter	uncommon	NL
razorbill	<i>Alca torda</i>	winter resident	winter	uncommon	SGCN

CONSTRUCTION AND OPERATIONS PLAN

Site Characterization and Assessment of Impacts – Biological Resources

Taxonomic Group	Species	Regional Use	Season Offshore	General Abundance Offshore	New York Status ^{a/}
Passerines					
American robin	<i>Turdus migratorius</i>	migrant	spring, fall	occasional	NL
tree swallow	<i>Tachycineta bicolor</i>	migrant	spring, fall	occasional	NL
yellow-rumped warbler	<i>Setophaga coronata</i>	migrant	spring, fall	occasional	NL
<p>SOURCES: Bay State Wind avian ship surveys, May–October 2017 (Bay State Wind 2019), MassCEC aerial surveys, November 2011–January 2015 (Veit et al. 2016)</p> <p>NOTES: ^{a/} Status: ST = State Threatened, SGCN = State Species of Greatest Conservation Need, BCC = USFWS Bird of Conservation Concern for Region 30, NL = non-listed.</p>					

CONSTRUCTION AND OPERATIONS PLAN

Site Characterization and Assessment of Impacts – Biological Resources

Sunrise Wind Export Cable–OCS

The SRWEC–OCS is primarily located in a pelagic environment, and bird species composition, distribution, seasonality, and resource base are likely to be similar to that described for the SRWF. Species groups likely to occur include petrels and shearwaters, gannets, cormorants, sea ducks, gulls, terns, and migratory passerines. The SRWEC–OCS is within federal offshore waters where a variety of marine birds and/or non-marine migratory bird species may seasonally occur. Small fish and zooplankton in the water column and benthic organisms, such as mollusks and crustaceans, may provide foraging opportunities for birds in this area. Species groups will have varying degrees of abundance around the SRWEC–OCS depending upon the distance from shore. Overall, the proposed route of the SRWEC–OCS generally does not pass through high bird concentration areas, except for one area approximately 12.4 mi (10.8 nm, 20 km) from shore (Figure 4.4.6-2).

The results of NYSERDA 2016–2019 digital aerial surveys (Normandeau and APEM 2019) indicate which species may occur within the SRWEC–OCS. Many of the species observed during the NYSERDA digital aerial surveys were the same as those already listed in the SRWF (Table 4.4.6-2) but did document additional species, including piping plover. Table 4.4.6-3 summarizes only those additional species detected during the NYSERDA digital aerial surveys and not during the Bay State Wind or MassCEC surveys, which overlapped with the SRWF.

CONSTRUCTION AND OPERATIONS PLAN

Site Characterization and Assessment of Impacts – Biological Resources

Table 4.4.6-3 Timing, Distribution, and Status of Additional Avian Species Likely to Occur within or Proximate to the SRWEC–OCS based on Regional NYSERDA Survey Data

Taxonomic Group	Species	Regional Use	Season Offshore	General Abundance Offshore	New York Status ^{a/}
Grebes					
horned grebe	<i>Podiceps auritus</i>	migrant, winter resident	winter	occasional	SGCN, BCC
Petrels and Shearwaters					
Audubon's shearwater	<i>Puffinus lherminieri</i>	migrant	summer, fall	occasional	BCC
black-capped petrel	<i>Pterodroma hasitata</i>	migrant	summer, fall	very rare	Candidate for federal listing
Wading birds					
great blue heron	<i>Ardea herodias</i>	summer breeder, migrant, winter resident	spring, fall	occasional	NL
snowy egret	<i>Egretta thula</i>	summer breeder, migrant, winter resident	spring, fall	occasional	SGCN, BCC
Swans and Geese					
Canada goose	<i>Branta canadensis</i>	migrant, winter resident	fall	occasional	NL
tundra swan	<i>Cygnus columbianus</i>	migrant, winter resident	fall	occasional	NL
Ducks					
American black duck	<i>Anas rubripes</i>	migrant, winter resident	fall	occasional	SGCN-HP
bufflehead	<i>Bucephala albeola</i>	migrant, winter resident	fall	occasional	NL
common goldeneye	<i>Bucephala clangula</i>	migrant, winter resident	fall	occasional	SGCN
common merganser	<i>Mergus merganser</i>	migrant, winter resident	fall	occasional	NL
gadwall	<i>Anas strepera</i>	migrant, winter resident	fall	occasional	NL
lesser scaup	<i>Aythya affinis</i>	migrant, winter resident	fall	occasional	SGCN
mallard	<i>Anas platyrhynchos</i>	migrant, winter resident	fall	occasional	NL
Sea Ducks					
king eider	<i>Somateria spectabilis</i>	winter resident	winter	uncommon	NL

CONSTRUCTION AND OPERATIONS PLAN

Site Characterization and Assessment of Impacts – Biological Resources

Taxonomic Group	Species	Regional Use	Season Offshore	General Abundance Offshore	New York Status ^{a/}
Raptors					
bald eagle	<i>Haliaeetus leucocephalus</i>	migrant	spring, fall	occasional	ST, SGCN, BCC
osprey	<i>Pandion haliaetus</i>	migrant	spring, fall	occasional	SSC
Shorebirds and Phalaropes					
American oystercatcher	<i>Haematopus palliatus</i>	summer breeder	summer, fall	occasional	SGCN, BCC
black-bellied plover	<i>Pluvialis squatarola</i>	winter resident	summer, fall	occasional	SGCN
dunlin	<i>Calidris alpina</i>	winter resident	summer, fall	occasional	NL
piping plover	<i>Charadrius melodus</i>	summer breeder, migrant	summer, fall	occasional	FT, SE, SGCN-HP
red phalarope	<i>Phalaropus fulicarius</i>	migrant	summer, fall	uncommon	NL
red-necked phalarope	<i>Phalaropus lobatus</i>	migrant	summer, fall	uncommon	NL
ruddy turnstone	<i>Arenaria interpres</i>	winter resident	summer, fall	occasional	SGCN
sanderling	<i>Calidris alba</i>	winter resident	summer, fall	occasional	NL
semipalmated plover	<i>Charadrius semipalmatus</i>	migrant	summer, fall	occasional	NL
Skuas and Jaegers					
great skua	<i>Stercorarius skua</i>	winter resident	winter	rare	NL
parasitic jaeger	<i>Stercorarius parasiticus</i>	migrant	spring, fall	uncommon	NL
pomarine jaeger	<i>Stercorarius pomarinus</i>	migrant	spring, fall	uncommon	NL
south polar skua	<i>Stercorarius maccormicki</i>	migrant	spring, fall	rare	NL
Gulls					
Bonaparte's gull	<i>Chroicocephalus philadelphia</i>	winter resident	winter	common	SGCN
glaucous gull	<i>Larus hyperboreus</i>	winter resident	winter	rare	NL
Iceland gull	<i>Larus glaucoides</i>	winter resident	winter	rare	NL
lesser black-backed gull	<i>Larus fuscus</i>	winter resident	winter	rare	NL
little gull	<i>Hydrocoloeus minutus</i>	winter resident	winter	rare	NL

CONSTRUCTION AND OPERATIONS PLAN

Site Characterization and Assessment of Impacts – Biological Resources

Taxonomic Group	Species	Regional Use	Season Offshore	General Abundance Offshore	New York Status ^{a/}
ring-billed gull	<i>Larus delawarensis</i>	breeding, migrant, winter resident	spring, summer	occasional	NL
Terns and Skimmers					
black tern	<i>Chlidonias niger</i>	migrant	spring, fall	rare	SE
Forster's tern	<i>Sterna forsteri</i>	breeding, migrant	summer, fall	occasional	SGCN
least tern	<i>Sternula antillarum</i>	breeding, migrant	summer, fall	occasional	ST, SGCN, BCC
royal tern	<i>Thalasseus maximus</i>	migrant	spring, fall	occasional	NL
Auks					
Atlantic puffin	<i>Fratercula arctica</i>	winter resident	winter	uncommon	NL
black guillemot	<i>Cephus grylle</i>	winter resident	winter	uncommon	NL
thick-billed murre	<i>Uria lomvia</i>	winter resident	winter	common	NL
Nightjars					
common nighthawk	<i>Chordeiles minor</i>	migrant	spring, fall	occasional	SSC
Passerines					
snow bunting	<i>Plectrophenax nivalis</i>	winter resident	spring, fall	occasional	NL
<p>SOURCE: Based on species observed during NYSEDA 2016–2019 surveys (Normandeau and APEM 2019), that were not observed during Bay State Wind or MassCEC surveys, which overlapped with the SRWF. Table does not include those species (i.e., some species of petrel, storm-petrel, booby, and pelican) that are only common to regions far south of the Project and are not expected to occur as far north as the SRWEC–OCS.</p> <p>NOTES: ^{a/} Status: FE = Federally Endangered, FT = Federally Threatened, SE = State Endangered, ST = State Threatened, SSC = State Species of Special Concern, SGCN = State Species of Greatest Conservation Need, SGCN-HP = High Priority State Species of Greatest Conservation Need, BCC = USFWS Bird of Conservation Concern for Region 30, NL = non-listed</p>					

CONSTRUCTION AND OPERATIONS PLAN

Site Characterization and Assessment of Impacts – Biological Resources

Sunrise Wind Export Cable–NYS

Generally, the avian species composition along the SRWEC–NYS is similar to the SRWEC–OCS, as described above (Table 4.4.6-3). As the SRWEC–NYS approaches the landfall location at Smith Point County Park, coastal marine birds are likely to dominate the species assemblages. Coastal birds typically forage within sight of land, while offshore species feed out of sight of land but within the Atlantic OCS. Truly pelagic species forage at the frontal zone along or beyond the continental shelf break (Furness and Monaghan 1987; Schrieber and Burger 2001; Gaston 2004) and thus will generally not use coastal waters and are unlikely to occur around the SRWEC–NYS. Shallower waters within the SRWEC–NYS provide foraging opportunities for terns, particularly the roseate tern (which feeds on sand lance), as well as sea ducks, loons, gulls, and cormorants. Terns and related species forage over shallow waters and sand spits nearshore in pursuit of small prey fish (Nisbet et al. 2014). Shorebirds are expected to forage at shoreline areas near the cable landfall location as the SRWEC–NYS approaches the shore (see Onshore Facilities discussion below).

Onshore Facilities

A wide variety of shorebirds, wading birds, passerines, and other land birds use the habitats of Fire Island, Great South Bay, Narrow Bay, and Bellport Bay in the vicinity of the cable landfall area and ICW crossing area, for stopover locations for foraging, sheltering, and/or breeding opportunities and have the potential to use habitats intersected by the proposed Onshore Transmission Cable and associated Onshore Facilities. There is no designated Critical Habitat for any ESA-listed species within the Project Area of the Onshore Facilities (USFWS 2020). The Official Species List generated from the IPaC database indicates that federally listed piping plover, red knot, and roseate tern have the potential to occur in the Project Area (USFWS 2020), and all three species have the potential to utilize beach or other coastal habitats adjacent to the SRWEC and Onshore Facilities.

The location where the SRWEC will make landfall consists of beach habitat where piping plover have historically nested from April through September. Fire Island at Smith Point Park had 25 breeding pairs of piping plover in 2018 (Jennings 2018). During an April 24, 2020, teleconference with NYSDEC and USFWS, NYSDEC noted that piping plovers do not typically nest in front of beach access points. Red knots are known to be present only during spring and fall migratory periods, along salt meadows and mudflats of the South Shore of Long Island. Roseate terns generally migrate through the region during spring and fall, and have historically nested at FINS, and on small islands off of Long Island as well. Results of the 2018 Long Island colonial waterbird surveys found over 2,000 roseate tern breeding pairs on Great Gull Island, approximately 48 mi (42 nm, 77 km) east-northeast of Smith Point County Park (Jennings 2018). Surveys on coastal Long Island also reported active breeding sites for least tern (*Sterna antillarum*; state threatened), common tern, Forster's tern (*Sterna forsteri*), black skimmer (*Rynchops niger*; state Special Concern), and gull-billed tern (*Gelochelidon nilotica*; state species of Greatest Conservation Need) (Jennings 2018). During the April 24, 2020, teleconference, NYSDEC indicated that terns have historically nested on dredged material adjacent to the Smith Point Marina parking lot.

CONSTRUCTION AND OPERATIONS PLAN

Site Characterization and Assessment of Impacts – Biological Resources

The NYNHP inquiry response also indicated that piping plover, least tern, and common tern have been documented in the vicinity of the Onshore Facilities (NYNHP 2020a). Each of these species may utilize resources at or adjacent to the Onshore Facilities, by means of foraging, nesting, or migrating through the area.

Shorebirds will forage in the intertidal zones of beaches for invertebrates, small crustaceans, bivalve mollusks, small polychaete worms, insects, and talitrid amphipods (Macwhirter et al. 2002). Terns and related species, and cormorants will forage over shallow waters and sandspits near shore for small prey fish (Nisbet et al. 2017; Dorr et al. 2020). Gulls may feed on small fish and invertebrates in intertidal and beach habitats (Nisbet et al. 2020). Some species of shorebirds may use beach habitats of Fire Island for breeding; other shorebirds, terns, gulls and cormorants may use beach habitats for loafing/roosting.

Terrestrial wetlands and upland habitats may be used for foraging, breeding, and roosting by wading birds, raptors, passerines and other land birds. Most of the Onshore Transmission Cable route and the OnCS–DC occur adjacent to marginal or unsuitable habitat for breeding birds. Potential habitats adjacent to the Onshore Facilities include marsh and terrestrial wetlands where wading birds may occur; and riparian zones, residential, woodland, small fields, and other upland habitats where passerines and raptors may occur (Table 4.4.6-4). And, while not breeding in beach or coastal habitats where the SRWEC will make landfall, a variety of other bird groups such as gulls and cormorants may use habitats proximate to the Onshore Facilities for roosting and/or foraging.

Table 4.4.6-4 Timing, Distribution, and Status of Avian Species Groups Likely to Occur within or Proximate to the Onshore Facilities

Taxonomic Group/Species	Seasonal Use	Primary Seasons	Primary Habitat (beach/intertidal, terrestrial wetland, upland)	General Abundance
shorebirds	breeding, migrant, winter resident	spring, summer, fall	beach/intertidal	common
wading birds	breeding, migrant, winter resident	spring, summer, fall	beach/intertidal, terrestrial wetland	common
gulls	breeding, migrant, winter resident	year-round	beach/intertidal	abundant
terns	breeding, migrant	summer, fall	beach/intertidal	common
passerines	breeding, migrant, winter resident	spring, summer, fall	upland, terrestrial wetland	abundant
raptors	breeding, migrant, winter resident	spring, summer, fall	upland (exc. osprey, primary habitat is beach/ intertidal, and terrestrial wetland)	common

SOURCE:

New York State Breeding Bird Atlas, 2000–2005 (New York State Breeding Bird Atlas 2007).

CONSTRUCTION AND OPERATIONS PLAN

Site Characterization and Assessment of Impacts – Biological Resources

4.4.6.2 Potential Impacts

Construction, O&M, and decommissioning activities associated with the SRWF, SRWEC, and Onshore Facilities have the potential to cause both direct and indirect impacts on avian species. IPFs associated with the construction and O&M phases of the Project are identified on Figure 4.4.6-3 and described separately, by phase, for the SRWF, SRWEC, and Onshore Facilities in the following sections. For the decommissioning phase of the Project, impacts are anticipated to be similar to or less adverse than those described for construction; therefore, impacts from decommissioning are not addressed separately in this section.

Additional information on impacts and risks to avian species including bird collision and displacement vulnerability assessments are presented in Appendix P. The approach for Appendix P was discussed with USFWS on April 24 and June 5, 2020. Marine bird exposure and vulnerability to collision and displacement due to visible infrastructure was assessed on a scale of minimal to high¹⁷, and vulnerability level was used to evaluate potential population-level impacts¹⁸. For marine and federally protected birds, this assessment discusses the potential for population-level impacts. For non-marine and unlisted marine birds, potential impacts are discussed by species group.

¹⁷ Vulnerability to potential effects due to exposure of IPF may range from minimal to high, and are defined as: minimal – limited exposure to IPF and, therefore, little or no vulnerability to impact; low – low exposure to IPF with low to medium vulnerability to impact depending on species conservation status or other factors such as restricted habitat requirements; medium – moderate exposure to IPF with medium to high vulnerability of impact depending on species conservation status or other factors such as restricted habitat requirements; and, high – high exposure to IPF and, therefore, medium to high vulnerability of impact depending on species conservation status or other factors such as restricted habitat requirements.

¹⁸ A population-level impact would be one that would potentially threaten the persistence of a regional population.

CONSTRUCTION AND OPERATIONS PLAN

Site Characterization and Assessment of Impacts – Biological Resources

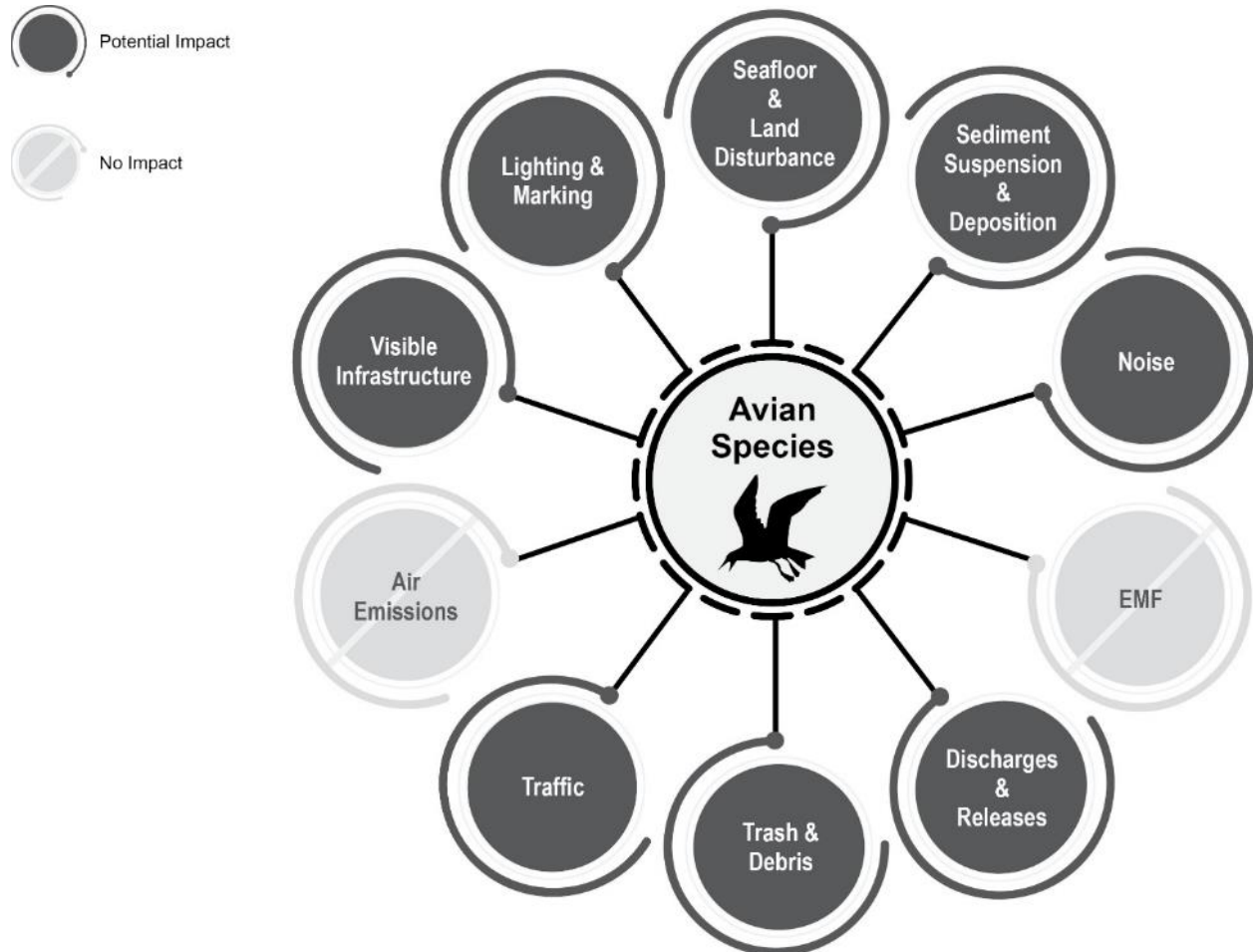

Figure 4.4.6-3 Impact-Producing Factors on Avian Species

Sunrise Wind Farm

The IPFs associated with the SRWF that could impact avian species include seafloor disturbance, sediment suspension and deposition, noise, traffic, visible infrastructure (i.e., WTGs, OCS-DC), lighting, discharges and releases, and trash and debris. These IPFs have the potential to affect migratory and resident marine birds such as loons and grebes, petrels, shearwaters, gannets, cormorants, sea ducks, gulls, terns and skimmers, alcids, and migrant passerines. The potential exists for impacts to listed or candidate species, including piping plover (federally threatened), red knot (federally threatened), roseate tern (federally endangered), least tern (state threatened), and black-capped petrel (candidate for federal listing). Some of these species groups may forage, migrate over, and/or rest in the vicinity of the SRWF. These IPFs are less likely to affect species that predominantly occur on the coast or inland, such as shorebirds, wading birds, and land birds (passerines and raptors). The potential impacts associated with these IPFs for each phase of the SRWF are addressed separately in the following sections and for each species group.

CONSTRUCTION AND OPERATIONS PLAN

Site Characterization and Assessment of Impacts – Biological Resources

Construction

IPFs with the potential to result in impacts to avian species in the SRWF during construction are summarized in the following sections. Only IPFs with the potential to result in impacts are included.

Seafloor Disturbance

During construction, seafloor preparation, foundation installation, scour protection installation, vessel anchoring, and cable installation activities will result in seafloor disturbance. However, the small footprint of disturbance relative to the large expanse of similar habitat available within and adjacent to the SRWF and in the broader region will provide birds habitat outside the disturbance area associated with construction of the SRWF. See Section 4.2.1 for further discussion of seafloor disturbance.

The construction activities may indirectly impact the availability of prey for marine birds (e.g., bivalve communities foraged on by sea ducks, sand lance foraged on by terns, and menhaden foraged on by multiple taxonomic groups; Fox and Petersen 2019), though the SRWF would be considered marginal foraging habitat for sea ducks, since the SRWF depth of 41–58 m is below the limit of diving depth for sea ducks (Goudie et al. 2000; Robertson and Savard 2020; Bordage and Savard 2020). See Section 4.4.2 for further discussion of construction activity impacts on marine invertebrates and vertebrates. Any changes to prey base composition for marine birds during construction may result in the temporary and localized loss of foraging opportunities. However, the small footprint of temporary disturbance relative to the large expanse of similar habitat available within and adjacent to the SRWF and in the broader region will allow birds to access comparable prey species outside the disturbance area associated with construction of the SRWF.

Sediment Suspension and Deposition

During construction, seafloor preparation, foundation installation, scour protection installation, vessel anchoring, and cable installation activities will result in sediment suspension and deposition. Construction activities will result in short-term, localized increases in turbidity close to the seafloor and in the water column (see Section 4.2.2). For foraging birds, such as gannets, cormorants, sea ducks, terns and gulls, this could reduce visibility and inhibit prey detection in the localized area of construction activities. However, the small footprint and short-term length of disturbance relative to the large expanse of similar habitat available within and adjacent to the SRWF and in the broader region will allow birds to access comparable prey species outside localized disturbance areas.

Sediment suspended during submarine cable installation is expected to be localized and to quickly resettle (see Appendix H – *Sediment Transport Modeling*). Therefore, potential impacts are considered localized and temporary.

CONSTRUCTION AND OPERATIONS PLAN

Site Characterization and Assessment of Impacts – Biological Resources

Noise

In-air and underwater noise generated during installation of the WTG and OCS–DC foundations could lead to effects on birds including loons and grebes, petrels, shearwaters, gannets, cormorants, sea ducks, gulls, terns, skimmers, and migrant passerines, including temporary avoidance of the SRWF construction area (Fox and Petersen 2019). Though birds may be exposed to increased sound levels, this would only last for the duration of the piling, and birds may temporarily avoid the area. Since construction noise will be short-term, it is not expected to cause permanent displacement.

Discharges and Releases

Accidental discharges, releases, and disposal could both directly and indirectly affect marine birds (e.g., oiling of feathers and/or ingestion of toxins, which could reduce fitness and/or survival and potentially impact breeding success). However, Project-related marine vessels operating during construction will be required to comply with regulatory requirements for management of onboard fluids and fuels, including prevention and control of discharges. Trained, licensed vessel operators will adhere to navigational rules and regulations, and vessels will be equipped with spill containment and cleanup materials. Additionally, Sunrise Wind will comply with applicable international (IMO MARPOL), federal (USCG), and state regulations and standards for reporting treatment and disposal of solid and liquid wastes generated during all phases of the Project. As described in Appendix E1 – *Emergency Response Plan / Oil Spill Response Plan*, some liquid wastes will be permitted as discharge into marine waters (i.e., domestic water, deck drainage, treated sump drainage, uncontaminated ballast water, and uncontaminated bilge water); these are not expected to pose an adverse impact to marine resources as they will quickly disperse, dilute, and biodegrade (BOEM 2014).

All vessels will similarly comply with USCG standards regarding ballast and bilge water management. Liquid wastes from vessels (including sewage, chemicals, solvents, and oils and greases from equipment) will be properly stored, and disposal will occur at a licensed receiving facility. As required by 30 CFR 585.626, chemicals to be utilized during the Project are provided in Appendix E1, and in Table 3.3.1-2 and Table 3.3.6-2. Any unanticipated discharges or releases are expected to result in minimal, temporary impacts; activities are heavily regulated and unpermitted discharges are considered accidental events that are unlikely to occur. In the unlikely event that a reportable spill were to occur, the National Response Center would be notified, followed by the EPA, BOEM, and USCG, as outlined in Appendix E1.

Trash and Debris

Accidental disposal of trash into the water has the potential to indirectly impact birds through accidental ingestion or entanglement in debris. Ingestion of macroplastics and microplastics can affect birds by interfering with flight and foraging, as well as reducing fitness and/or survival due to the plastics acting as a vector for other contaminants (Teuten et al. 2009; Yamashita et al. 2011; Tanaka et al. 2013; Roman et al. 2019).

Any active vessel operating within a marine environment has the potential to create trash and debris. However, the discharge or disposal of solid debris into offshore waters from OCS structures and vessels is prohibited by BOEM (30 CFR 250.300) and the USCG (MARPOL, Annex V, Pub. L. 100-220 [101 Stat. 1458]).

CONSTRUCTION AND OPERATIONS PLAN

Site Characterization and Assessment of Impacts – Biological Resources

In accordance with applicable federal, state, and local laws, Sunrise Wind will implement comprehensive measures prior to and during Project construction activities to avoid and minimize impacts related to trash and debris disposal. All trash and debris will be properly stored on vessels for later disposal or on land at an appropriate facility per 30 CFR 585.626(b)(9). Trash and debris will be contained on vessels and offloaded at port or construction staging areas. Food waste that has been ground and can pass through a 25-mm mesh screen may be disposed of according to 33 CFR 151.51-77. All other trash and debris returned to shore will be disposed of or recycled at licensed waste management and/or recycling facilities. Disposal of any other form of solid waste or debris in the water will be prohibited, and good housekeeping practices will be implemented to minimize trash and debris in vessel work areas. These practices will include orderly storage of tools, equipment, and materials, as well as proper waste collection, storage, and disposal to keep work areas clean and minimize potential environmental impacts. With proper waste management procedures, the potential for trash or debris to be inadvertently left overboard or introduced into the marine environment is not anticipated.

Traffic

Vessel and helicopter traffic could also cause some species of birds, including loons and grebes, petrels, shearwaters, gannets, cormorants, sea ducks, terns, skimmers, and migrant passerines, to temporarily avoid the area, or, for other species, potential attraction to vessel traffic (as gulls are attracted to fishing vessels). In some very rare cases birds may collide with the vessels at night if vessels flush birds resting on the water. However, construction traffic will be short-term and similar to normal, non-Project-related traffic and is not likely to cause permanent displacement or a high risk of collision mortality.

Visible Infrastructure

During construction, visible infrastructure has the potential to cause direct impacts. The presence of construction equipment and components of WTGs and OCS-DC could present collision hazards, particularly at night and during periods of poor visibility. However, construction activities are short-term and will be generally confined to good weather. There may be some activities that will occur at night during which structures may be lit for navigation and safety purposes; potential effects related to lighting are discussed below.

Lighting

During construction, lighting has the potential to cause indirect impacts, because the lighting of construction vessels and equipment may attract birds—particularly during poor weather—and consequently increase risk of collision (Fox et al. 2006). Brightly illuminated structures offshore, such as research platforms, pose a risk to birds migrating at night, including shorebirds, terns and other marine birds, and passerines, and particularly during rain or fog when birds can become disoriented by sources of artificial light (Hüppop et al. 2006). However, construction activities are short-term and are generally confined to good weather. Furthermore, lighting during construction activities will be limited to the minimum required by BOEM and USCG for safety during construction activities to minimize impacts to birds.

CONSTRUCTION AND OPERATIONS PLAN

Site Characterization and Assessment of Impacts – Biological Resources

Operations and Maintenance

IPFs with the potential to result in impacts to avian species in the SRWF during the O&M phase are described in the following sections; note that seafloor disturbance and sediment suspension and deposition are not discussed as these IPFs are expected to be similar to construction impacts, but are expected to occur less often during O&M. Visible infrastructure may result in indirect effects associated with displacement; alternatively, direct effects may result from visible infrastructure in the form of collision mortality or injury. Noise, traffic, and discharges and releases may result in either direct or indirect effects, as discussed below.

Noise

While the effects of WTG noise on birds is not well studied, noise from WTGs and OCS–DC may contribute to the indirect effect of some species of birds avoiding the SRWF during the operation. The WTGs primarily produce two types of noise, aerodynamic blade and mechanical noise (MMS 2008), and there is some evidence to indicate that there are lower densities of birds around operational versus stationary WTGs (Cook et al. 2018), perhaps partly due to the noise of the WTGs. Sounds produced by WTGs are expected to largely be drowned out by the sounds of wind and waves; therefore, risk of long-term effects associated with operational noise is considered minimal. The presence of visible infrastructure is more of a factor contributing to avian displacement impacts (as discussed below) and not operational noise.

Discharges and Releases

Impacts from accidental discharges and releases during O&M are expected to be similar to but of lesser likelihood than during construction, as there will be fewer Project-related marine vessels during this phase, and regulatory requirements and preventative measures will still apply. Unpermitted discharges or releases are considered accidental events, and in their unlikely occurrence, these are expected to result in minimal, temporary impacts. Permitted discharges are not expected to pose an adverse impact to marine resources as they will quickly disperse, dilute, and biodegrade (BOEM 2014).

Trash and Debris

Impacts from marine disposal of trash and debris during O&M are expected to be similar to but of lesser likelihood than during construction, as there will be fewer Project-related marine vessels during this phase, and regulatory requirements and preventative measures will still apply. The unanticipated marine disposal of trash and debris is considered an unpermitted, accidental event, and containment and good housekeeping practices will be implemented to minimize the potential.

CONSTRUCTION AND OPERATIONS PLAN

Site Characterization and Assessment of Impacts – Biological Resources

Traffic

Vessels and helicopters associated with maintenance have the potential to disturb marine birds (e.g., loons and grebes, petrels, shearwaters, gannets, cormorants, sea ducks, gulls, terns, and skimmers) and may affect the distribution of birds foraging near the SRWF (Fox and Petersen 2019), which has the potential to cause indirect effects (e.g., increased energy use as birds fly to alternate foraging areas) and in rare cases the direct effect of potential collisions with vessels. While some birds may be attracted to, or avoid maintenance vessels, these behavioral responses are expected to have minimal potential effects and will be short-term and localized to areas with O&M related vessel traffic.

Visible Infrastructure

Potential effects to birds due to visible infrastructure include displacement (Fox and Petersen 2019) or attraction, which could potentially result in collision (NYSERDA 2017a). Birds could be attracted to offshore structures including WTGs for perching. Cormorants and large gulls have regularly been observed roosting on above-water structures in the marine environment, and terns have been observed perching on turbine bases at European offshore facilities before the towers were constructed (Dierschke et al. 2016). Cormorants, peregrine falcon, kestrel, and groups of pigeons have been observed perching on WTG deck platforms (20 m [65.6 ft] asl) at an offshore wind project in Europe (Hill et al. 2014). Birds also could be attracted to WTGs due to changes in the prey base around underwater structures (Kragefky 2014; Dierschke et al. 2016). Fish are known to congregate around floating or stationary structures in the marine environment, and WTG foundations may create a localized artificial reef effect, where fish may find shelter or food (Kragefky 2014). Turbulence (i.e., waves and shifting currents) at WTGs may force prey sources to the surface, providing potential foraging opportunities for birds (Dierschke et al. 2016).

Displacement Risk

The potential for displacement or attraction is species-dependent and influenced by a species' use of the area (NYSERDA 2017a); therefore, these potential effects are discussed for each major species group, with additional information on federally protected species.

Overall, displacement from the SRWF is not expected to affect the populations of non-marine migratory birds, such as shorebirds, wading birds, raptors, and passerines, because SRWF is not primary habitat for these species and any avoidance behavior during migration is not likely to substantially increase energetics or reduce foraging opportunities (a detailed assessment is in Appendix P). The SRWF is generally far enough offshore as to be beyond the migration range of most terrestrial or coastal bird species. Coastal birds, including shorebirds (e.g., sandpipers, plovers), waterbirds (e.g., cormorants, grebes), waterfowl (e.g., scoters, mergansers), wading birds (e.g., herons, egrets), raptors (e.g., falcons, eagles), and songbirds (e.g., warblers, sparrows), may occasionally forage at SRWF, visit the area sporadically, or pass through on their spring and/or fall migrations.

CONSTRUCTION AND OPERATIONS PLAN

Site Characterization and Assessment of Impacts – Biological Resources

A summary of potential effects detailed in Appendix P is as follows:

Coastal and Land Birds

- **Shorebirds:** No shorebirds were observed offshore during the Bay State regional avian studies (Bay State Wind 2019). Viet et al. (2016) documented phalaropes in their spring surveys in areas that overlapped with the SRWF. Telemetry data collected by BOEM and USFWS indicate that piping plover and red knot have the potential to cross the SRWF (Loring et al. 2018, 2019). With the exception of phalaropes, shorebird exposure to SRWF operation is likely to be minimal and limited to migratory periods, and any avoidance behavior/displacement effects during migration are not expected to cause decreased fitness due to the small footprint of the SRWF relative to available habitat in the larger Atlantic OCS. Viet et al. (2016) documented phalaropes during their spring surveys in areas that overlapped with the SRWF. These species may migrate over the SRWF or may occasionally stopover in the vicinity of the SRWF to forage or rest on the water. Due to the sporadic occurrence of this species group across locations in the broader Atlantic OCS region and the relatively small footprint of the SRWF, these species are not significantly at risk of displacement.
- **Wading Birds:** No wading birds were observed during the Bay State regional avian ship-based surveys; a single wading bird, a great blue heron (*Ardea herodias*), was observed during the OSAMP ship-based surveys (Bay State Wind 2019; Paton et al. 2010). Wading birds spend most of the year in onshore, freshwater ecosystems and nearshore marine ecosystems. Exposure to the SRWF would be limited to migratory periods only; therefore, any avoidance behavior is not expected to result in displacement effects.
- **Raptors:** The Bay State regional avian surveys had no observations of raptors within SRWF (Bay State Wind 2019). Biodiversity Research Institute tracked peregrine falcons during a long-term study along the North Atlantic Coast to distances as far offshore as the SRWF, and in the general vicinity of the SRWF (DeSorbo et al. 2012, 2018a, 2018c, as cited by BRI 2019). Use of the offshore environment by raptors is generally limited to migration. Some species of raptors such as peregrine falcons or merlins may be attracted to the above-water structures for potential perching opportunities and may launch foraging flights from structures if their avian prey species are also in the area. These occurrences are expected to be rare events given the SRWF distance from shore. Therefore, risk of impacts associated with displacement or attraction are unlikely because exposure is expected to be relatively low and limited to migration.
- **Passerines:** Passerine exposure during SRWF operation is expected to be minimal as songbirds do not depend on offshore habitats for foraging or staging, and songbird use of the SRWF is expected to be limited to migratory periods. During the Bay State Wind boat-based surveys, passerines were observed in low numbers (Bay State Wind 2019). Since use of the offshore environment is limited to migration, any avoidance behaviors/displacement effects are not expected to cause displacement from important habitat.

CONSTRUCTION AND OPERATIONS PLAN

Site Characterization and Assessment of Impacts – Biological Resources

Overall, displacement from the SRWF is not expected to affect populations of marine birds due to the small footprint of the Project relative to the larger Atlantic OCS and the spacing between turbines. Birds flying within offshore wind farms appear to favor locations where turbines are spaced more widely (Krijgsveld 2014). This suggests that the SRWF indicative layout scenario with WTGs and OCS–DC sited in a uniform east-west/ north-south grid with 1.15 by 1.15-mi (1 by 1-nm; 1.85 by 1.85-km) spacing will minimize the potential for impacts such as barrier effects and displacement. Displacement impacts to certain marine bird groups may be considered medium impacts. A summary of potential effects detailed in Appendix P is as follows:

Marine Birds

- **Loons:** Loon vulnerability to displacement is considered high; however, they have low to medium population vulnerability (Appendix P). Loons may pass through SRWF during spring and fall migration, forage in the SRWF, and were observed in survey areas that overlapped with the SRWF in winter (Veit et al. 2016). Loons are consistently identified as being vulnerable to displacement impacts associated with offshore wind development (Garthe and Hüppop 2004; Furness et al. 2013; MMO 2018). However, displacement from the SRWF is unlikely to impact population trends because of the relatively small size of SRWF in relation to available loafing and foraging habitat in the larger Atlantic OCS. Further, due to water depths and suitable loon foraging habitat generally closer to shore, the SRWF is not considered important loon foraging habitat.
- **Sea Ducks:** Sea duck vulnerability to displacement is considered high and they have a medium to high population vulnerability (Appendix P). Sea duck activity in the SRWF is expected to be limited to migration or travel between wintering sites. Sea duck species including scoters, long-tailed ducks, and common eiders were observed in study areas that overlapped with the SRWF during winter (Veit et al. 2016). Sea ducks have been identified as being vulnerable to displacement (MMO 2018), although impacts may generally be temporary (Leonhard et al. 2013). Overall, habitat loss due to displacement from the Project is unlikely to impact population trends because of the relatively small size of SRWF in relation to available foraging habitat.
- **Petrels, Shearwaters, and Storm-Petrels:** The petrel group is commonly observed throughout the region during the summer months, and this group of species was observed in survey areas that overlapped with the SRWF in summer (Veit et al. 2016). Petrels, shearwaters, and storm-petrels rank at the bottom of displacement vulnerability assessments in the Atlantic OCS (Willmott et al. 2013) because they are not restricted to specific areas for foraging opportunities. Therefore, population-level impacts from displacement to this species group is unlikely.
- **Gannets and Cormorants:** Northern gannet (*Morus bassanus*) were among species observed during winter surveys that overlapped with the SRWF (Veit et al. 2016). Studies based in Europe have found that northern gannets exhibit some avoidance of offshore wind developments (Krijgsveld et al. 2011; Cook et al. 2012; Hartman et al. 2012; Vanermen et al. 2015; Dierschke et al. 2016; Garthe et al. 2017; Skov et al. 2018), indicating the species would likely be vulnerable to displacement on the Atlantic OCS. While there is uncertainty on how displacement will affect individual fitness, population-level impacts are unlikely because of a relatively low baseline occurrence in the SRWF.

CONSTRUCTION AND OPERATIONS PLAN

Site Characterization and Assessment of Impacts – Biological Resources

Cormorant exposure is considered minimal as this bird group is more abundant closer to shore (they require perches to warm their body temperature after foraging in cold water), and only one cormorant was observed during Bay State regional avian studies (Bay State Wind 2019). Cormorants are considered to have little vulnerability to displacement because they have been found to be attracted to WTGs based on available studies (Krijgsveld et al. 2011; Lindeboom et al. 2011). Population-level impacts from displacement are unlikely due to gannet and cormorant low-baseline exposure.

- **Gulls, Skuas, and Jaegers:** Skua and jaeger exposure during SRWF operation is considered minimal, while gull exposure is minimal to medium depending on the species. Great black backed gull (*Larus marinus*) and herring gull (*Larus argentatus*) were among species of gull observed during winter surveys that overlapped with the SRWF (Veit et al. 2016). Gulls are generally considered to have little vulnerability to displacement (Furness et al. 2013); therefore, population-level impacts from displacement are unlikely.
- **Terns:** Common tern and roseate tern were among species of tern that were observed during late spring/summer surveys that overlapped with the SRWF (Veit et al. 2016). Telemetry data collected by BOEM and USFWS indicate that common and roseate terns have the potential to cross the SRWF (Loring et al. 2019). Terns have a medium to high vulnerability to displacement (Appendix P). Terns may be vulnerable to displacement since they have been demonstrated to avoid small (660 kW) operating WTGs (Vlietstra 2007). While some individual terns will be exposed to the SRWF, if displaced they would be expected to find alternative local foraging options; therefore, population-level impacts from displacement are not expected.
- **Alcids:** Razorbills (*Alca torda*) were observed during winter surveys that overlapped with the SRWF (Veit et al. 2016). Alcids are considered vulnerable to displacement (Willmott et al. 2013). Due to sensitivity to disturbance from vessel traffic and high habitat specialization, many alcids rank high in displacement vulnerability assessments (Furness et al. 2013; Willmott et al. 2013; Dierschke et al. 2016; Wade et al. 2016). While there is uncertainty about how displacement may affect individual fitness, it is unlikely that displacement from the SRWF area will result in population-level impacts given the relatively small size of the SRWF relative to available foraging habitat in the broader region.

Listed Species

Displacement from the SRWF is not expected to affect listed species populations. A summary of potential effects are as follows (see Appendix P for further details):

- **Piping Plover, Red Knot:** Piping plover and red knot exposure to the SRWF is limited to spring and fall migration. Piping plovers are not considered vulnerable to displacement because their feeding habitat is strictly coastal (Burger et al. 2011) as is also the case for red knots; therefore, population impacts from displacement are unlikely.

CONSTRUCTION AND OPERATIONS PLAN

Site Characterization and Assessment of Impacts – Biological Resources

- **Eagles:** Eagle exposure to SRWF operation is limited because SRWF is not located along any likely or known eagle migration route and eagles avoid expending excessive energy during migration (including crossing large expanses of water). Eagles are also expected to have little vulnerability to displacement because they tend not to actively forage in or fly through the offshore environment. Therefore, population impacts to eagles during operation of the SRWF are unlikely.
- **Black-capped Petrel:** Black-capped petrels are extremely uncommon in areas not directly influenced by the warmer waters of the Gulf Stream (Haney 1987) and are generally found in coastal waters of the US only as a result of tropical storms (Lee 2000). Since they are extremely uncommon in northeastern waters, population-level impacts are highly unlikely.
- **Roseate Tern:** Roseate tern exposure during SRWF operation is considered low, based on the Bay State Wind (2019) and MassCEC surveys (Veit et al. 2016), as well as BOEM and USFWS telemetry tracking data (Loring et al. 2019). Roseate terns may be vulnerable to displacement since terns have been demonstrated to avoid small (660 kW) operating WTGs (Vlietstra 2007). While some individual terns may be exposed to the SRWF, if displaced, they would be expected to be able to take advantage of other nearby more important foraging areas in the region such as the Muskeget Channel between Martha's Vineyard and Nantucket Island (Veit et al. 2016); therefore, population-level impacts associated with displacement from the SRWF are unlikely.

Collision Risk

Visible infrastructure may also result in the direct effect of mortality or injury due to collision (Drewitt and Langston 2006; Fox et al. 2006; Goodale and Milman 2016). The primary hazards that could pose a collision risk are the presence and operation of WTG and OCS–DC structures. For the WTGs, collisions may occur within the rotor-swept zone (RSZ), with the WTG foundation, tower, or hub (refer to Figure 3.3.8-1). The potential for collision events to occur is species-dependent. Therefore, the potential effects of the SRWF are discussed below for each major species group, with additional information on federally protected species. Collision impacts to listed species would be considered a medium impact; however, population level impacts are not expected.

Overall, collisions with the SRWF are not expected to affect the populations of non-marine migratory birds, such shorebirds, wading birds, raptors, and passerines because the SRWF is generally far enough offshore as to be beyond the predominant migratory range of most breeding land-based bird species, and flight heights of most migratory shorebirds and passerines are expected to occur well above the RSZ of the SRWF (Appendix P).

Coastal and Land Birds

- **Shorebirds:** Shorebirds are expected to have minimal exposure to the SRWF and are generally expected to occur at great heights (above 4,000 m [13,123.4 ft] [Hüppop et al. in press]) during migration and are expected to generally occur well above the proposed RSZ if traveling over the SRWF during spring and/or fall migration. Shorebirds have demonstrated avoidance behaviors when approaching offshore WTGs in Europe (Petersen et al. 2006). Based on minimal exposure and documented avoidance behaviors, shorebirds are not considered at significant risk of collision impacts.

CONSTRUCTION AND OPERATIONS PLAN

Site Characterization and Assessment of Impacts – Biological Resources

Phalaropes may migrate over the SRWF or may occasionally stopover in the vicinity of the SRWF to forage or rest on the water. If they were to occur in the SRWF, they may be at risk while landing or taking off. However, due to the sporadic occurrence of this species group across locations in the broader Atlantic OCS, occurrences within the SRWF are expected to be relatively infrequent and population-level impacts are not expected.

- **Wading Birds:** Crossings of the SRWF by wading birds are expected to be rare as these birds are primarily coastal and land based. There is limited flight height information for wading birds offshore in the vicinity of the SRWF, but available data suggest low flight heights over water (<10 m [32.8 ft]; Appendix P). Exposure to the SRWF is expected to be minimal and limited to migratory periods only, and population-level impacts due to collision are unlikely.
- **Raptors:** Like other terrestrial species, since use of the offshore environment is generally limited to migration, population-level impacts due to collision are unlikely. Some species of raptors such as peregrine falcons or merlins may occasionally occur as far offshore as the SRWF, and falcons may be attracted to the above-water structures for potential perching opportunities and may launch foraging flights from structures if their avian prey species are also in the area. However, these occurrences are expected to be rare events given the SRWF distance from shore. While falcons have some vulnerability to collision with offshore WTGs (see detailed assessment is in Appendix P), population-level impacts are unlikely because exposure is expected to be low and will be limited to migration.
- **Passerines:** Passerine exposure during SRWF operation is expected to be minimal as songbirds do not depend on offshore habitats for foraging or staging, and songbird use of the SRWF is expected to be limited to migratory periods. Passerines typically migrate at night at heights less than 1,640 ft (499.9 m) over land, but sometimes over 1,640 ft (499.9 m) in suitable atmospheric conditions (Gauthreaux 1991), and they can fly lower during inclement weather or when flying into headwinds and have been documented at relatively low heights during diurnal boat-based surveys in the region of the SRWF (Appendix P). Overall, population-level impacts are unlikely because, while these birds have some vulnerability to collision, they have minimal to low exposure to the SRWF.

Overall, collisions with the SRWF are not expected to affect the populations of marine birds. Of the marine birds vulnerable to collision, gulls are expected to have the highest exposure to the SRWF. A summary of potential collision effects is as follows (see Appendix P for further details):

Marine Birds

- **Loons, Sea Ducks, Petrels, Shearwaters, and Storm-Petrels:** As indicated in Appendix P, these groups have low to medium collision vulnerability. Since loons demonstrate high avoidance behavior, they are generally not considered to be vulnerable to collision (Wade et al. 2016; Furness et al. 2013). Sea ducks, petrels, shearwaters, and storm-petrels are generally not considered vulnerable to collision because they have exhibited avoidance to WTGs and fly primarily below the RSZ of the smallest WTG model under consideration (Appendix P).

CONSTRUCTION AND OPERATIONS PLAN

Site Characterization and Assessment of Impacts – Biological Resources

- **Gannets and Cormorants:** Gannets and cormorants have a low to medium vulnerability to collision (Appendix P), consistent with other vulnerability assessments (Furness et al. 2013; Wade et al. 2016). Vulnerability assessments indicate that if gannets do not avoid wind farms, they may have limited vulnerability to collision (Wade et al. 2016). Northern gannets are vulnerable to collision (Furness et al. 2013), but documented high avoidance behavior likely reduces their collision risk (Garthe et al. 2017; Skov et al. 2018). Population-level impacts are unlikely due to high avoidance behavior and overall low exposure. Cormorants are considered to be vulnerable to collision because they may be attracted to WTGs for perching opportunities (Krijgsveld et al. 2011; Lindeboom et al. 2011) and often fly through RSZs. However, population-level impacts are unlikely due to their low exposure.
- **Gulls, Skuas, and Jaegers:** skua and jaeger exposure during SRWF operation is considered minimal, while gull exposure is may be medium depending on the species. Population level impacts are not expected for skuas and jaegers due to low exposure to the SRWF. However, gull species are considered highly vulnerable to collision due to observed continued use of offshore wind farms during operation (Furness et al. 2013; Willmott et al. 2013). In addition, gulls are known to be attracted to WTGs (Vanermen et al. 2015) and collision with WTGs has been documented (Skov et al. 2018). While gulls are likely to be exposed to the SRWF and are vulnerable to collision and some species demonstrated a high population vulnerability (Appendix P), overall population-level impacts due to collision are unlikely because local gull populations are stable and increasing, and this species group generally shows high reproductive success rates (Good 1998; Pollet et al. 2012; Burger 2015; Nisbet et al. 2017).
- **Terns:** Terns rank at the medium vulnerability level in collision vulnerability assessments (Garthe and Hüppop 2004; Furness et al. 2013; Willmott et al. 2013). Terns have a medium collision vulnerability and high population vulnerability (Appendix P). Their vulnerability is generally due to their foraging behaviors and flight heights, as well as potential occurrence offshore during the breeding period and migratory staging periods. However, terns fly almost exclusively below the RSZ (Loring et al. 2019) and can potentially avoid rotating WTGs (Burger et al. 2011). While some individual terns will be exposed to the SRWF, they are considered to have low to medium collision vulnerability to large WTGs; therefore, population-level impacts are unlikely.
- **Alcids:** Alcids have a low to medium collision vulnerability (Appendix P). Alcids are generally not considered vulnerable to collision (Wade et al. 2016) because they primarily fly below the RSZ and demonstrate high avoidance behavior toward offshore wind farms (Willmott et al. 2013).

CONSTRUCTION AND OPERATIONS PLAN

Site Characterization and Assessment of Impacts – Biological Resources

A summary of potential collision effects to federally listed species is as follows (see Appendix P for further details):

Listed Species

- **Piping Plover:** Piping plovers generally migrate at flight heights above a typical maximum RSZ of modern offshore wind turbines (250 m [76.2 m] asl) (Loring et al. 2019), and they have good visual acuity and maneuverability in the air (Burger et al. 2011). Thus, potential risk of collision with WTGs is minimal. Since exposure of piping plovers to the SRWF is limited to migration, population-level impacts are unlikely.
- **Red Knot:** Flight heights during migration are thought to be well above the RSZ for long-distance migrant red knots, but there is potential for exposure to collision for shorter-distance migrants that can traverse the SRWF within the RSZ, particularly during the fall (Loring et al. 2018). Given that red knot exposure is likely to be limited to migration, population impacts are unlikely.
- **Eagles:** Eagles are expected to have minimal vulnerability to collision because they tend not to actively forage in or fly through the offshore environment. Therefore, impacts to eagles during operation of the SRWF are highly unlikely.
- **Black-capped Petrel:** This species is extremely uncommon in northeastern waters; therefore, impacts are highly unlikely.
- **Roseate Tern:** Overall, compared to other seabirds, terns rank in the middle of collision vulnerability assessments (Furness et al. 2013; Willmott et al. 2013), fly less than 13 percent of time between 66 and 492 ft (20.1–150 m; Cook et al. 2012), and have been observed to avoid operating WTGs (Vlietstra 2007). Terns have also been documented to lower their flight altitude when approaching an offshore wind farm (Krijgsveld et al. 2011). The altitude at which roseate terns migrate offshore is still being researched but is thought to be higher than foraging altitudes or nearshore flight altitudes (likely hundreds to thousands of feet/meters; Perkins et al. 2004; MMS 2008). Therefore, due to limited exposure, population-level impacts are unlikely.

In summary, indirect (displacement) and direct (collision) effects associated with visible infrastructure are expected to vary depending upon the species group, although population-level impacts are not expected. Sunrise Wind will take measures to reduce perching opportunities at operating turbines, if appropriate based on further consultations with state and federal agencies. Due to the operational cut-in and cut-out wind speed limitations, the WTGs may not be operating approximately 2 to 3 percent of the time during winter months, approximately 2 to 4 percent of the time during spring and fall months, and approximately 3 to 5 percent of the time during summer months. Avian species would be at less risk of collision when the blades are not spinning; however, collision with stationary WTG structures during periods of low visibility would still be considered a risk.

Refer to Appendix P for more details regarding the assessment of marine bird exposure and vulnerability to the SRWF.

CONSTRUCTION AND OPERATIONS PLAN

Site Characterization and Assessment of Impacts – Biological Resources

Lighting

Lighting on WTG and OCS–DC structures could result in the attraction of birds during periods of low visibility. Brightly illuminated structures offshore pose a risk to birds migrating at night, particularly during rain or fog when birds can become disoriented by sources of artificial light (Hüppop et al. 2006). The Project is evaluating the implementation of methods to limit the visual impact of the aviation light, for example light dimming or the use of a radar-based ADLS to turn on, and off, the aviation obstruction lights in response to detection of aircraft in proximity to the SRWF. Sunrise Wind will use ADLS or related means (e.g., dimming or shielding) to limit visual impact, pursuant to approval by the FAA and BOEM and commercial and technical feasibility at the time of FDR/FIR approval. In addition to limiting visual impact, reducing lighting will also reduce the potential for impacts to birds. Lighting impacts associated with SRWF operation are expected to vary depending upon the species group (see *Visible Infrastructure* above for a discussion of collision vulnerability by species group), although population-level impacts are expected to be avoided by minimizing lighting.

Sunrise Wind Export Cable

The IPFs associated with the SRWEC–OCS and SRWEC–NYS that could directly or indirectly impact avian species include seafloor or land disturbance, sediment suspension/deposition, visible infrastructure (i.e., vessels), lighting, noise, traffic, discharges/releases, and trash/debris during both construction and O&M. The potential impacts are expected to be similar between the SRWEC–OCS and SRWEC–NYS. Species groups likely to occur in these areas include loons and grebes, petrels, shearwaters, gannets, cormorants, sea ducks, gulls, and terns and skimmers, and the overall species composition as the SRWEC approaches landfall will be dominated by coastal species such as shorebirds, wading birds, gulls, terns and skimmers. The potential impacts associated with these IPFs are addressed separately for each phase (i.e., construction and O&M) in the following sections.

Construction

IPFs with the potential to result in impacts to avian species in the SRWEC–OCS and SRWEC–NYS during construction are summarized in the following sections.

Seafloor Disturbance and Sediment Suspension and Deposition

Direct impacts from construction activities related to the installation of the SRWEC–OCS and SRWEC–NYS to marine and coastal marine birds are expected to be similar to those described within the construction section of the SRWF in terms of the IPFs of seafloor disturbance and sediment suspension and deposition. However, there may be slight differences in sediment suspension and deposition at various locations along the SRWEC and within the SRWF due to variation in the benthic sediment characteristic across these areas (e.g., sand, mud, or gravel), as well as variable currents and water depths. Additionally, the interconnection of the SRWEC–NYS to the Landfall HDD Work Area will cause disturbances to the benthic and intertidal areas that could potentially indirectly impact birds that forage in the nearshore area by temporarily displacing and/or obscuring their prey base (e.g., invertebrates foraged on by shore birds and ducks) by reducing visibility and inhibiting prey-detection.

CONSTRUCTION AND OPERATIONS PLAN

Site Characterization and Assessment of Impacts – Biological Resources

Potential effects on prey species are expected to be temporary in nature (i.e., limited to a small area around work activities), and birds will likely only need to fly a short distance to find alternative prey sources in similar adjacent habitats. BMPs will be in place to minimize the opportunity for turbid discharges leaving construction work areas. Additionally, as detailed in Appendix H, TSS concentrations were predicted to return to ambient levels (<10 mg/L) within 0.4 hours from completing SRWEC–OCS installation, within 0.34 hours from completing SRWEC–NYS installation, and within 0.3 hours from completing the exit pit excavation required for HDD activities in NYS waters. The TSS plumes are expected to be contained within the lower portion of the water column, approximately 9.8 ft (3 m) above the seafloor for SRWEC installation and approximately 7.2 ft (2.2 m) above the seafloor for HDD activities.

Impacts to the seafloor and resulting sediment deposition from SRWEC installation activities would be temporary and impacts resulting in potential changes to prey base composition and inhibited prey detection would be short-term and minimal due to the availability of other foraging habitats outside of localized construction areas.

Noise

Above and below water noise generated by cable installation activities at the SRWEC–OCS and SRWEC–NYS could lead to indirect effects including temporary displacement of pelagic marine and coastal marine birds from construction areas. Since construction noise will be temporary it is not likely to cause long-term displacement effects to pelagic marine and coastal marine birds.

Discharges and Releases

The potential for avian exposure and adverse impacts from routine and non-routine discharges, releases, trash, and debris will be similar to those identified for the SRWF. Additionally, HDD at landfall will use a drilling fluid that consists of bentonite, drilling additives, and water. A barge or jack-up vessel may also be used to assist the drilling process, handle the pipe for pull in, and help transport the drilling fluids and mud for treatment, disposal and/or reuse. To minimize the potential risks for an inadvertent drilling fluid release, an Inadvertent Return Plan will be developed and implemented during construction. Refer to Section 3.3.3.3 for additional details regarding HDD installation and the use of drilling fluids.

Trash and Debris

Accidental disposal of trash into the water does represent a risk to birds as they could potentially ingest or become entangled in debris. Ingestion of macroplastics and microplastics can affect birds by interfering with flight and foraging as well as reduced fitness and/or survival, due to the plastics acting as a vector for other contaminants (Teuten et al. 2009; Yamashita et al. 2011; Tanaka et al. 2013; Roman et al. 2019). However, with proper waste management procedures, the potential for trash or debris to be inadvertently left overboard or introduced into the marine environment is not anticipated.

CONSTRUCTION AND OPERATIONS PLAN

Site Characterization and Assessment of Impacts – Biological Resources

Traffic

Vessel traffic associated with construction of the SRWEC–OCS and SRWEC–NYS could temporarily attract some birds and cause others to avoid the area, or in rare cases, the direct effect of birds colliding with the vessels at night. However, these impacts will be short-term and similar to normal, non-Project-related vessel traffic and are not likely to cause any permanent loss of habitat or significant collision mortality.

Visible Infrastructure

During construction of the SRWEC–OCS and NYS, the presence of construction equipment and vessels could present collision hazards, particularly at night and during periods of poor visibility. However, construction activities are short-term and will be generally confined to good weather. There may be some activities that will occur at night during which these structures may be lit for navigation and safety purposes; potential effects related to lighting are discussed below.

Lighting

During construction activities of the SRWEC–OCS and SRWEC–NYS, lighting on vessels or construction equipment has the potential to cause short-term indirect impacts. Artificial lighting sources may attract birds, increasing collision risk during poor weather (Fox et al. 2006). Brightly illuminated structures offshore, such as research platforms, pose a risk to birds migrating at night, particularly during rain or fog when birds can become disoriented by sources of artificial light (Hüppop et al. 2006). Since construction activities are short-term and are generally confined to good weather, potential impacts are considered minimal. Furthermore, lighting during construction activities will be limited to the minimum required for safety during construction activities to minimize impacts.

Operations and Maintenance

Regular O&M activities are not expected to result in measurable impacts to avian species at the SRWEC–OCS and SRWEC–NYS. There will be periodic vessel use to monitor the cable for proper burial depth; however, associated traffic will be comparable to or less frequent than other, non-Project related traffic and will, therefore, be negligible. In the event that maintenance of the cable is required, potential IPFs and related effects will be temporary and similar to those discussed for Construction.

Onshore Facilities

The IPFs associated with the Onshore Facilities with the potential to impact avian species include land disturbance, sediment suspension and deposition, noise, traffic, visible infrastructure and lighting, discharges and releases, and trash and debris. These IPFs have the potential to affect avian species that utilize habitats within or adjacent to the Onshore Facilities' components. Potential direct and indirect impacts associated with these IPFs for each phase of the Onshore Facilities, including disturbance, avoidance, or injury/mortality are addressed in the following sections. A more detailed discussion of impacts is available in Appendix P.

Construction

IPFs with the potential to result in impacts to avian species at the Onshore Facilities during the construction phase are summarized in the following sections. Only IPFs with the potential to result in effects/impacts are discussed.

CONSTRUCTION AND OPERATIONS PLAN

Site Characterization and Assessment of Impacts – Biological Resources

Land Disturbance

Potential direct impacts to avian species resulting from land disturbance generated by construction of the Onshore Facilities include habitat loss and potential direct mortality/injury of individuals. Habitat loss is defined as when an area previously supporting wildlife is converted to non-habitat that lacks the natural resources to support occupancy by any species, such as paved areas. The results of habitat evaluations in the field are included in Appendix L.

The OnCS–DC construction in the Town of Brookhaven and in minimal areas along the Onshore Transmission Cable and Onshore Interconnection Cable will result in initial land disturbance and tree clearing. The Union Avenue Site is primarily a developed industrial/commercial site with small narrow rows of trees along parcel boundaries; minimal vegetation clearing would be required at this location (Appendix L). Construction of the OnCS–DC, Onshore Transmission Cable, and Onshore Interconnection Cable is expected to result in approximately 2.3 acres (0.9 ha) of permanent tree clearing. Sunrise Wind will use mechanical clearing methods for the construction of the Project and does not intend to use any herbicides/pesticides during the construction phase and thus direct (potential exposure to toxins) and indirect (potential impacts to habitat) impacts to birds related to herbicides/pesticides will be avoided during construction.

The Onshore Transmission Route/Interconnection Cable is generally located within the paved portion of existing roadway or utility-owned or controlled property and previously disturbed and developed areas to the extent practicable to minimize impacts to natural habitat. The duct bank for the Onshore Transmission Cable will be installed via open trench excavation for the majority of the Cable. Terrestrial land cover types adjacent to the Onshore Transmission Cable mainly consists of developed residential or industrial land uses, with the exception of forested wetlands and waterways at the Carmans River crossing (Stantec 2020d). The Project will utilize trenchless crossing installation to avoid sensitive environmental resources or other physical obstructions (i.e., railroads) at certain crossing locations. The use of trenchless crossings for installation of portions of the Onshore Transmission Cable/Interconnection Cable, such as in the vicinity of the Carmans River, will minimize impacts to terrestrial habitats.

Coastal habitats associated with the Landfall/ICW Work Area on Fire Island include foreshore, backshore, dune, and interdunal areas (Appendix L). The Landfall Work Area occupies a portion of the parking lot at Smith Point County Park on Fire Island, an approximately 425-acre (172 ha) public beach and recreation area.

The workspaces at the Landfall/ICW Work Area at Smith Point County Park and Smith Point Marina will be located within paved areas of the parking lots or open land used for recreational activities but stringing activities may occur on the beach. The use of HDD for installation will minimize impacts to onshore habitats.

Vegetation clearing and grading required for the Landfall Work Area at Smith Point is not expected to alter beach habitat utilized by shorebirds and other species including terns, because most activity will occur within an existing parking lot.

CONSTRUCTION AND OPERATIONS PLAN

Site Characterization and Assessment of Impacts – Biological Resources

There will be no direct impacts to intertidal and beach areas during installation of the Landfall HDD and ICW HDD. However, this activity may include stringing the conduit out on the beach, which could temporarily alter/partially cover the existing habitat; HDD conduit stringing is anticipated to occur for 2 to 3 weeks per duct between October and March, outside of the nesting period for shorebirds.

Early successional habitat in the temporary workspace and access locations will initially revegetate as a grass/forb and herbaceous cover, then will gradually transition to shrub and sapling cover. Habitat loss will be minimal in the Town of Brookhaven area because in addition to forested areas, the baseline habitat conditions of this general area include developed residential areas, mowed lawns, parking lots, roads, and commercial and industrial areas.

Land disturbance from construction of the Onshore Facilities may result in the direct injury or mortality of avian species. Mobile individuals (i.e., adults and fledglings) are able to temporarily vacate an area of disturbance and, therefore, are less susceptible to mortality or injury compared to less mobile stages including eggs and nestlings. Direct mortality and injury would only occur during the construction phase. Time-of-year restrictions for certain work activities (e.g., HDD conduit stringing and tree removal) will be employed to the extent feasible to avoid or minimize direct impacts to terrestrial habitat and RTE species during construction of the Onshore Facilities. If work is anticipated to occur outside of these time-of-year restriction periods, Sunrise Wind will work with state and federal agencies to develop construction monitoring and impact minimization plans or mitigation plans, as appropriate.

The amount of habitat loss is small relative to the amount of similar habitat that will remain unimpacted in the general region. Sunrise Wind will comply with state and federal regulations, and the Project's ISMP, to manage the spread of invasive plant species. Therefore, there may only be minimal impacts associated with land disturbance during construction.

Sediment Suspension and Deposition

Some minimal seafloor disturbance would occur along the northern shoreline of Smith Point County Park during arrival of the temporary floating pier from the spuds of the floating pier itself as well as the spuds from the barge as it arrives to offload equipment. However, this would be a temporary impact and considered a minimal impact to foraging birds, if present, and limited to the periods when these activities are actively taking place.

The Project will utilize trenchless crossing installation to avoid sensitive environmental resources at certain crossing locations which will avoid direct impacts to surface waters and wetlands. Any sediment impacts to waterbodies crossed are therefore expected to be temporary, with the habitat returning to pre-existing conditions after construction activities cease.

Noise

Construction activities at the Onshore Facilities that will temporarily increase ambient noise will include use of equipment for HDD and trenchless crossings, trenching, cable pulling, and typical construction vehicles (e.g., excavators, dump trucks, and paving equipment). Construction activities will occur along the Onshore Transmission Cable route during both daytime and nighttime periods.

CONSTRUCTION AND OPERATIONS PLAN

Site Characterization and Assessment of Impacts – Biological Resources

HDD activities at the Landfall HDD Work Area and Onshore Transmission Cable/Interconnection Cable will generate noise and vibrations, which could disturb shorebirds. Piping plovers and red knots are among species sensitive to disturbances and may flush in response (USFWS 2009; Peters and Otis 2007). Construction activities at the Landfall HDD and ICW HDD Work Areas are expected to be completed outside of the nesting period for shorebirds.

Noise and vibrations associated with the operation of equipment for HDD or vegetation removal along the Onshore Transmission Cable route may temporarily displace land birds. Noise generated by construction has the potential to flush land birds and may also 'mask' bird calls potentially reducing the ability of birds to forage, communicate, or detect predators (Ortega 2012; Bottalico et al. 2015). These temporary effects could potentially lead to decreased breeding success. However, infrastructure associated with the Onshore Facilities will generally be sited within and adjacent to previously disturbed and developed areas, and noise disturbances will be limited to construction periods and localized areas with construction activity.

Discharges and Releases

Although no impacts from discharges and releases are anticipated, spills or accidental releases of fuels, lubricants, or hydraulic fluids could occur during use of trenchless installation methods, installation of the Onshore Transmission Cable or Onshore Interconnection Cable, or during construction activities at the OnCS–DC. An SPCC Plan will be developed and any discharges or releases will be governed by New York State regulations. Additionally, where HDD is utilized, an Inadvertent Return Plan will be prepared and implemented to minimize the potential risks associated with release of drilling fluids. Any unanticipated discharges or releases within the Onshore Facilities during construction are expected to result in minimal, temporary impacts; activities are heavily regulated, and discharges and releases are considered accidental events that are unlikely to occur.

Trash and Debris

Good housekeeping practices will be implemented to minimize trash and debris in onshore work areas. These practices will include orderly storage of tools, equipment, and materials, as well as proper waste collection, storage, and disposal to keep work areas clean and minimize potential environmental impacts. All trash and debris returned to shore from offshore vessels will be properly disposed of or recycled at licensed waste management and/or recycling facilities. Disposal of any solid waste or debris in the water will be prohibited. With proper waste management procedures, the potential for trash or debris to be inadvertently introduced onto an onshore area is unlikely.

Traffic

Traffic from construction vehicles (e.g., excavators, dump trucks, and paving equipment) will occur during construction of the Onshore Facilities. Potential direct impacts to land bird species from traffic including collisions with construction equipment or crushing of ground nests may, in very rare situations, occur. Traffic may also result in indirect effects such as displacement of land birds from construction areas, or disruption of normal behaviors within the vicinity of construction activities. However, the majority of the Onshore Transmission Cable route occurs within unsuitable habitat for many land bird species; therefore, risk of impacts to birds due to direct and indirect impacts from traffic is expected to be low.

CONSTRUCTION AND OPERATIONS PLAN

Site Characterization and Assessment of Impacts – Biological Resources

Visible Infrastructure

Visible infrastructure during construction of the Onshore Facilities will include the temporary floating pier which may be installed at Smith Point County Park, other construction equipment, and the OnCS–DC. Birds are expected to avoid collisions with stationary structures during periods of good visibility but may be at risk of collision at night (particularly when disoriented by lighting, as described below). In very rare cases, birds may be at risk of collision with moving construction equipment. However, the potential for impacts associated with collision with visible infrastructure during construction is minimal. If present for a few weeks in the fall and a few weeks in the spring, the temporary floating pier may also displace migratory shorebirds and wading birds from foraging within the intertidal areas within the footprint of the pier. However, this would be a temporary impact and considered a minimal loss of potential foraging habitat limited to the period when the pier may be present.

Lighting

Temporary lighting on construction equipment and the OnCS–DC during certain phases of construction may be needed, though construction, including clearing and grading, foundation and equipment installation, site restoration, and commissioning, is expected to take place primarily during the daylight hours. Nighttime lighting on construction equipment during specialized construction activities (e.g., HDD) may attract birds, particularly during periods of low visibility (e.g., rain and fog), and indirectly result in collision mortality or injury. However, nighttime lighting will be limited to the minimal required for safety. As construction activities will largely occur during daylight hours and will be short-term, the risk of potential impacts is low.

Operations and Maintenance

IPFs with the potential to result in impacts to avian species at the Onshore Facilities during the O&M phase are summarized in the following sections. Only IPFs with the potential to result in effects/impacts are included, therefore, sediment suspension and deposition, and trash and debris are excluded.

Land Disturbance

The vegetation management requirements for the Project during operations and maintenance are expected to be minimal. IVM practices may include manual cutting, mowing and the prescriptive use of federally-approved and state-registered herbicides to eliminate targeted plant species within the ROW. Sunrise Wind does not intend to use pesticides during operation of the Project. Herbicides would be applied, using federally-approved, NYS-listed herbicides, following all NYS and local regulations and label restrictions; therefore direct (potential exposure to toxins) and indirect (potential impacts to habitat) impacts to birds related to herbicide use during operations and maintenance is expected to be minimal.

CONSTRUCTION AND OPERATIONS PLAN

Site Characterization and Assessment of Impacts – Biological Resources

Noise

The proposed OnCS–DC will introduce new sources of sound, including converter transformers, shunt reactors, harmonic filters, and cooling and ventilation associated with the valve hall. Anthropogenic sources of noise have been shown to have negative impacts on fitness and breeding success of land birds (Kleist et al. 2018). However, the OnCS–DC is sited in an already developed area and sources of noise during O&M are expected to be comparable to general commercial and industrial activities already occurring in the area. Temporary noise may occasionally be generated for routine and non-routine maintenance activities. In such cases, short-term avoidance behavior and/or displacement of avian species may occur due to disruptions caused by noise, but these would be expected to be short-term and minimal.

Discharges and Releases

The OnCS–DC will require various oils, fuels, and lubricants to support its operation, and SF₆ gas will also be used for electrical insulating purposes. As described above in the construction section, although no impacts from discharges and releases are anticipated, accidental discharges, releases, and disposal could occur; however, risks will be avoided through implementation of the measures described in the SPCC Plan.

Trash and Debris

Solid waste and other debris will be generated predominantly during Project construction activities but may also occur during O&M of the Onshore Facilities. With the implementation of proper waste management procedures, and adherence to regulations, the potential for trash or debris to be inadvertently introduced onto an onshore area is unlikely.

Traffic

Temporary traffic may occasionally be generated for routine and non-routine maintenance activities. In such cases, short-term avoidance behavior and/or displacement of avian species may occur due to disruptions caused by traffic. In very rare cases, birds may be at risk of collision with moving vehicles. The risk of impacts associated with traffic is considered short-term and minimal.

Visible Infrastructure

The presence of the OnCS–DC may pose risk of mortality or injury due to collision with the OnCS–DC. These risks will exist throughout the O&M phase of the Project. However, birds outside of migration are mainly diurnal and would be able to visually detect the OnCS–DC structures during the day. Therefore, the risk of impacts due to collision with OnCS–DC structures is expected to be minimal due to minimization of nighttime lighting as explained below. The Onshore Transmission Cable and Onshore Interconnection Cable will be underground, thereby eliminating collision risk with overhead lines.

CONSTRUCTION AND OPERATIONS PLAN

Site Characterization and Assessment of Impacts – Biological Resources

Lighting

The presence of the OnCS–DC and associated nighttime lighting may pose risk of mortality or injury due to collision with the OnCS–DC. Nighttime lighting, particularly during periods of inclement weather during migration, could serve as an attractant to disoriented birds and increase their risk of collision with structures at the OnCS–DC. However, nighttime lighting will be limited to periods when O&M activities occur and use of nighttime lighting is expected to be infrequent. Lighting at the OnCS–DC will be limited to the minimal required for safety purposes. Impacts associated with collision risk due to lighting at the OnCS–DC are expected to be minimal due to minimization of nighttime lighting.

4.4.6.3 Proposed Environmental Protection Measures

Sunrise Wind will implement the following environmental protection measures to reduce potential impacts on avian species. These measures are based on protocols and procedures implemented for similar offshore projects.

- Sunrise Wind is committed to an indicative layout scenario with WTGs and the OCS–DC sited in a uniform east-west/north-south grid with 1.15 by 1.15-mi (1 by 1-nm; 1.85 by 1.85-km) spacing that aligns with other proposed adjacent offshore wind projects in the RI-MA WEA and MA WEA. This wide spacing of WTGs may reduce risk of barrier effects and/or displacement, and may allow avian species to avoid individual WTGs and minimize risk of potential collision. The WTGs will have an air gap from MSL to minimum blade swept height of 98 to 180 ft (30 to 55 m); birds crossing the area within this height range would not be at risk of collision with spinning blades.
- The distance of the SRWF offshore (greater than 15 mi ([13 nm, 24.1 km])) avoids coastal areas, which are known to concentrate birds, particularly shorebirds and sea ducks.
- Sunrise Wind will take measures to reduce perching opportunities at operating turbines, if appropriate based on further consultations with state and federal agencies.
- Sunrise Wind will document any dead (or injured) birds found incidentally on vessels and structures during construction, O&M, and decommissioning and provide an annual report to BOEM and USFWS.
- Sunrise Wind will use ADLS or related means (e.g., dimming or shielding) to limit visual impact, pursuant to approval by the FAA and BOEM, commercial and technical feasibility at the time of FDR/FIR approval, and dialogue with stakeholders. In addition to limiting visual impact, reducing lighting will also reduce the potential for impacts to avian species.
- Construction and operational lighting will be limited to the minimum necessary to ensure safety and compliance with applicable regulations. Limiting lighting to that which is required for safety and compliance with applicable regulations is expected to minimize impacts on avian species.
- Accidental spill or release of oils or other hazardous materials will be managed offshore through an ERP/OSRP and onshore through an SPCC Plan.

CONSTRUCTION AND OPERATIONS PLAN

Site Characterization and Assessment of Impacts – Biological Resources

- Time-of-year restrictions for certain work activities such as HDD conduit stringing will be employed to the extent feasible to avoid or minimize direct impacts to RTE avian species during construction of the Landfall. Time-of-year restrictions for tree removal at the Onshore Facilities to avoid impacts to northern long-eared bats would also benefit breeding birds. If work is anticipated to occur outside of these time-of-year restriction periods, Sunrise Wind will work with state and federal agencies to develop construction monitoring and impact minimization plans or mitigation plans, as appropriate.
- Onshore Facilities are primarily sited within previously disturbed and developed areas (e.g., roadways, ROWs, developed industrial/commercial areas) to the extent feasible, to minimize impacts to undisturbed avian habitat.
- An ISMP will be implemented to manage the spread of invasive plant species that could negatively impact native plants and avian habitat.
- The Onshore Transmission Cable and Onshore Interconnection Cable will not include any overhead utility poles, thus minimizing potential impacts to birds associated with overhead lines.
- Sunrise Wind is developing an avian post-construction monitoring plan for the Project that will summarize the approach to monitoring; describe overarching monitoring goals and objectives; identify the key avian species, priority questions, and data gaps unique to the region and Project Area that will be addressed through monitoring; and describe methods and time frames for data collection, analysis, and reporting. Post-construction monitoring will assess impacts of the Project with the purpose of filling select information gaps and supporting validation of the Sunrise Wind Avian Risk Assessment. Focus may be placed on improving knowledge of ESA-listed species occurrence and movements offshore, avian collision risk, species/species-group displacement, or similar topics. Where practicable, monitoring conducted by Sunrise Wind will build on and align with post-construction monitoring conducted by the other Orsted/Eversource offshore wind projects in the Northeast region. Sunrise Wind will engage with federal and state agencies and environmental groups (eNGOs) to identify appropriate monitoring options and technologies, and to facilitate acceptance of the final plan.

CONSTRUCTION AND OPERATIONS PLAN

Site Characterization and Assessment of Impacts – Biological Resources

4.4.7 Bats

This section describes the affected environment and potential effects from the construction and operation of the Project as they relate to bat species. The description of the affected environment and assessment of potential impacts to bats were developed by reviewing current public data sources related to bats, including published scientific literature and correspondence and consultation with federal and state agencies. The primary agency sources used include a NYNHP database inquiry response letter dated March 27, 2020, and a USFWS IPaC database inquiry response letter dated March 11, 2020. Primary empirical data sources include the following regional bat studies that overlap with, or are in close proximity to, the Project Area: vessel-based acoustic bat surveys conducted within the SRWF and the nearby Revolution Wind and South Fork Wind project areas (Stantec 2018a, 2019a,b,c, 2020a,b,c); Block Island Wind construction and post-construction acoustic bat surveys (Stantec 2016a, 2018b); Martha's Vineyard bat telemetry studies (Dowling et al. 2017); and Long Island northern long-eared bat (*Myotis septentrionalis*) telemetry surveys (NPS 2020; Stantec 2018c) and acoustic surveys (NPS 2020) (Figure 4.4.7-1). A description of the bat species composition and timing of occurrence in the Project Area is provided below, followed by an evaluation of potential Project-related impacts. More detailed information from available literature concerning bat risk at offshore wind developments is presented in Appendix P.

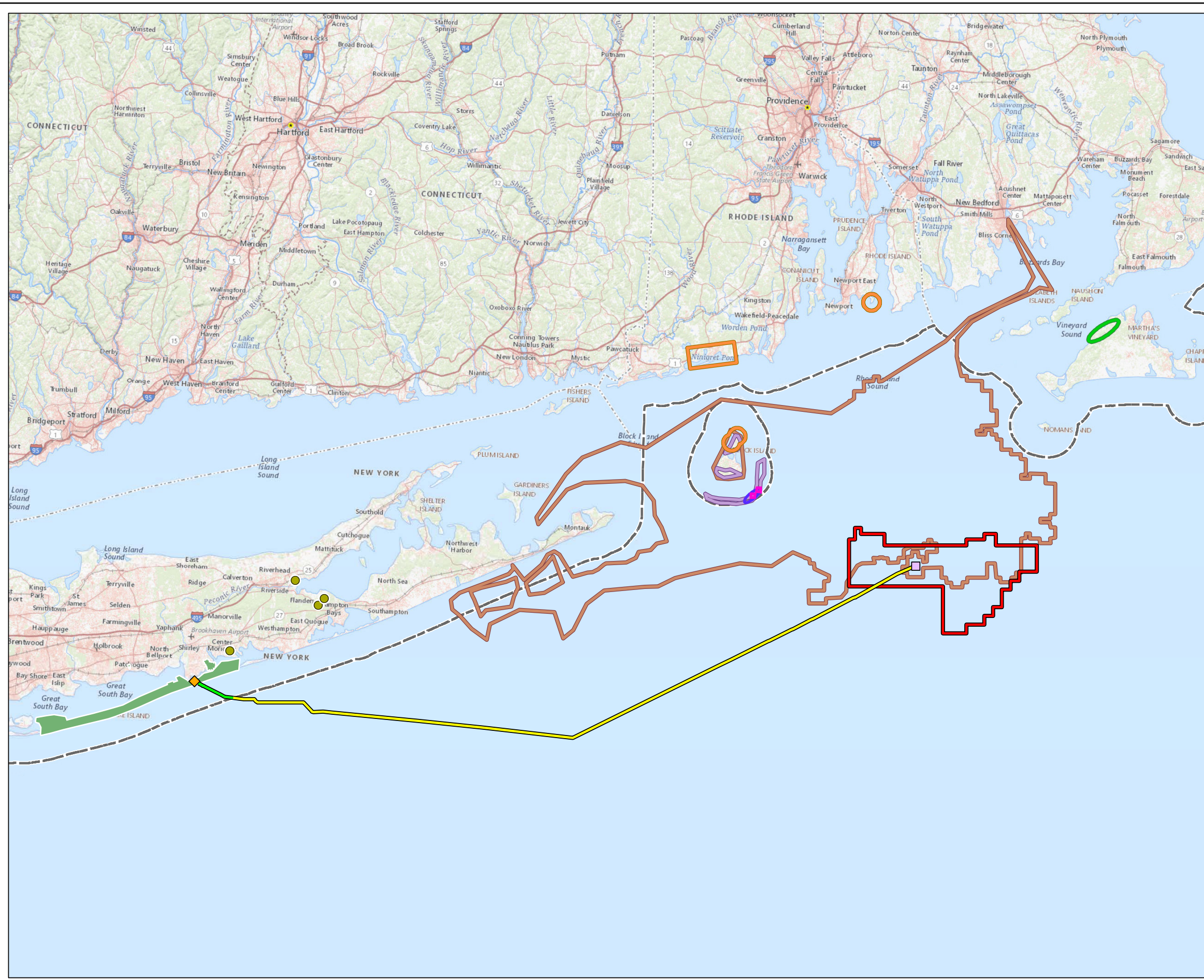

Figure 4.4.7-1
Bat Detections during Regional Vessel
Based Acoustic Bat Surveys

Sunrise Wind | Powered by **Ørsted & Eversource**

- Legend**
- Sunrise Wind Farm (SRWF)
 - Offshore Converter Station (OCS-DC)
 - SRWEC Landfall Location
 - Sunrise Wind Export Cable (SRWEC-OCS)
 - Sunrise Wind Export Cable (SRWEC-NYS)
 - 3-nm State Waters Boundary
 - NLEB Mist Netting Survey Location
 - NPS Fire Island Bat Monitoring Project
 - BIWF Post-construction Acoustic Surveys
 - BIWF Construction Phase
 - Vessel-based Acoustic Surveys
 - OSAMP Acoustic Surveys
 - BIWF Pre-construction Acoustic Surveys
 - Martha's Vineyard Telemetry Study Capture Locations
 - 2017-2019 Regional Vessel-Based Acoustic Bat Surveys

Sources
 Base Map: USGS The National Map, SFWF: Stantec 2018, Stantec 2019a, b, c; SRWF: Stantec 2020a; Revolution Wind Stantec 2020b

Date	12/18/2020 Revised: 6/1/2021
Project Number	2028113199
Prepared By	GC
Reviewed By	LJ

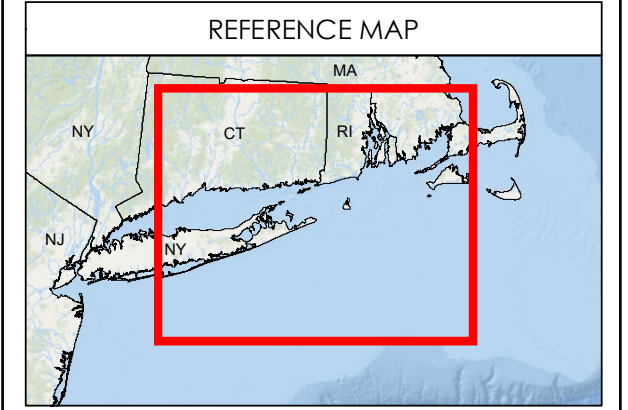
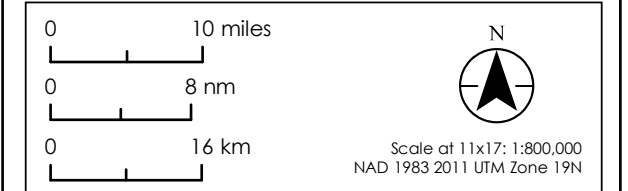

This page intentionally left blank

CONSTRUCTION AND OPERATIONS PLAN

Site Characterization and Assessment of Impacts – Biological Resources

4.4.7.1 Affected Environment

Regional Overview

There are nine species of bats present in the Northeast, eight of which may occur in the Project Area and six of which (cave-dwelling species) are year-round residents in the Northeast (Table 4.4.7-1; NYSDEC n.d.-a). Bat species can be divided into two major groups based on their wintering strategy: cave- hibernating bats and migratory tree bats. Cave-hibernating bats disperse shorter distances to caves or mines to overwinter, while migratory tree bats migrate longer distances to milder climates where they roost in trees. Both groups of bats are nocturnal insectivores that use a variety of forested and open habitats for foraging during the summer (BCI 2001).

During the late-summer and fall, cave-dwelling bats disperse from summer roosting habitat to hibernacula (BCI 2001; Maslo and Leu 2013). The NYNHP database inquiry response letter, dated March 27, 2020, did not indicate the occurrence of any known bat hibernacula in the vicinity of the Onshore Facilities (NYNHP typically screens projects for bat hibernacula within 40 mi [64.4 km]) (NYNHP 2020). Cave-dwelling species generally exhibit lower activity in the offshore environment than the migratory tree bats (Peterson et al. 2014; Sjollema et al. 2014; Stantec 2016b). The state- and federally threatened northern long-eared bat has the potential to occur in the corridor for the Onshore Facilities during the summer (NYNHP 2020; USFWS 2020; K. Gaidasz, NYSDEC, email comm.). While present in New York, the state and federally endangered Indiana bat (*Myotis sodalis*) is not known to occur in Nassau or Suffolk counties (USFWS n.d.) and is not among species of bat detected during regional offshore vessel-based acoustic bat surveys (Stantec 2018a, 2019a,b,c, 2020a,b,c).

Migratory tree bats fly to southern parts of the US to overwinter and have been documented offshore during aerial digital (Hatch et al. 2013) and vessel-based surveys during migratory periods (Stantec 2018a, 2019a,b,c, 2020a,b,c).

CONSTRUCTION AND OPERATIONS PLAN

Site Characterization and Assessment of Impacts – Biological Resources

Table 4.4.7-1 Bat Species on Long Island that Could Occur Within or Proximate to the SRWEC–NYS and Onshore Facilities

Species/Type ^{a/}	Scientific Name; Species Code	Status ^{b/}
Cave-hibernating bats		
eastern small-footed bat	<i>Myotis leibii</i> ; MYLE	SE (MA), SSC (NY), SGCN (NY)
little brown bat	<i>Myotis lucifugus</i> ; MYLU	SE (MA), SGCN-HP (NY)
northern long-eared bat	<i>Myotis septentrionalis</i> ; MYSE	FT, SE (MA), ST (NY), SGCN-HP (NY)
tri-colored bat	<i>Perimyotis subflavus</i> ; PESU	FSR, SE (MA), SGCN-HP (NY)
big brown bat	<i>Eptesicus fuscus</i> ; EPFU	NL
Migratory tree bats		
eastern red bat	<i>Lasiurus borealis</i> ; LABO	SGCN (NY)
hoary bat	<i>Lasiurus cinereus</i> ; LACI	SGCN (NY)
silver-haired bat	<i>Lasionycteris noctivigans</i> ; LANO	SGCN (NY)
NOTES:		
^{a/} "Type" refers to wintering strategy: cave-hibernating bats disperse shorter distances to caves or mines to overwinter, while migratory tree bats migrate longer distances to milder climates where they roost in trees.		
^{b/} Status: FE = Federally Endangered; FT = Federally Threatened; FSR = Federal Status Review resulting from a petition for listing; SE = State Endangered; ST = State Threatened; SSC = State Species of Special Concern; SGCN = State Species of Greatest Conservation Need; SGCN-HP = High Priority State Species of Greatest Conservation Need; NL = non-listed		

Available information suggest bats are more abundant at onshore and coastal locations compared to offshore. Acoustic studies conducted onshore at Rhode Island National Wildlife Refuge Complex and at FINS reported greater numbers of passes of bats compared to those detected during offshore studies (Smith and McWilliams 2016; NPS 2018; Stantec 2018a, 2019a,b, 2020a,b,c), and acoustic surveys conducted at both offshore and coastal sites in the Gulf of Maine, mid-Atlantic, and Great Lakes reported greater activity levels of bats at coastal sites compared to offshore sites (Stantec 2016b; NYSERDA 2017a, 2017b). However, it should be noted that direct comparisons to moving vessel-based acoustic bat surveys and stationary land-based acoustic bat surveys should be made with caution: detector surveys cannot distinguish between individual bats and stationary surveys would presumably have a greater chance of detecting the same individual bats over the course of a night.

Sunrise Wind Farm

While there is still some uncertainty on the specific movements and behaviors of bats offshore, bats have been documented using the marine environment off the Atlantic Coast (BOEM 2014; Hatch et al. 2013; Dowling and O'Dell 2018; Stantec 2016a,b, 2018a, 2019a,b,c, 2020a,b,c;). Bats have been observed to temporarily roost on structures such as lighthouses on nearshore islands (Dowling et al. 2017), on a geological survey vessel traversing offshore (Stantec unpubl.), as well as a stationary vessel at the construction site of Block Island Wind (Stantec 2016a). The literature suggests that during migration offshore, bats may opportunistically forage and may also take advantage of artificial roosting structures, if available (Ahlén 2006; Ahlén et al. 2007, 2009; Hutterer et al. 2005). There is little information available regarding bat flight heights offshore and flight heights may vary based on weather and species-specific behaviors.

CONSTRUCTION AND OPERATIONS PLAN

Site Characterization and Assessment of Impacts – Biological Resources

Hatch et al. (2013) detected eastern red bats (*Lasiurus borealis*) flying several hundred meters above sea level during digital aerial transect surveys over the mid-Atlantic (Hatch et al. 2013); based on their flight height, presumably these bats were migrating. Bat acoustic detectors generally have a maximum radius of detection of approximately 98 ft (30 m), and vessel-based acoustic bat detectors have generally been placed on the upper deck of G&G vessels (approximately 65 ft [20 m] above the water) (Stantec 2018a, 2019a,b,c, 2020a,b,c). It can be assumed that detected bats were occurring at heights of approximately 0 to 164 ft (0–50 m) above the water; however, bat passes above the range of detection would go undetected.

There is accumulating evidence of bats, particularly tree roosting species, migrating offshore over the north Atlantic (Hatch et al. 2013; Peterson et al. 2014; Stantec 2016a,b, 2018a, 2019a,b,c, 2020a,b,c; NYSERDA 2017a). It should be noted that the distances bats have been observed offshore may be limited to the distances traveled offshore by survey vessels. Bats have been documented as far as 81 mi (70 nm, 130.4 km) off the coast of New Jersey (Stantec 2016a), and in late-summer 2003, a group of *Myotis* was observed roosting on a fishing vessel 68 mi (59.1 nm, 109.4 km) from shore in the Gulf of Maine (Thompson et al. 2015, as cited by Dowling et al. 2017). In Maine, bats have been detected on islands up to 25.8 mi (22.4 nm, 41.5 km) from the mainland (Peterson et al. 2014). In a mid-Atlantic bat acoustic study conducted during the spring and fall of 2009 and 2010 (86 nights), the maximum distance that bats were detected from shore was 13.6 mi (11.8 nm, 21.9 km) and the mean distance was 5.2 mi (4.5 nm, 8.4 km) (Sjollema et al. 2014). In addition, eastern red bats were detected in the mid-Atlantic up to 27.3 mi (23.7 nm, 43.9 km) offshore by high resolution video aerial surveys (Hatch et al. 2013).

The number of bat passes and percentage of all passes detected by species and group during vessel-based acoustic surveys completed within the SRWF and other nearby offshore wind projects is presented in Table 4.4.7-2. Species composition was similar among vessel-based survey locations, with long-distance migratory bats (eastern red bats, silver-haired bats [*Lasionycteris noctivigans*], and hoary bats [*Lasiurus cinereus*]) generally representing the species most detected (Table 4.4.7-2). Table 4.4.7-3 describes the total number of bat passes and detection rate (number of passes per detector-night) by month for all bat species combined during the vessel-based surveys. The highest detection rates generally occurred during August, September, and October; though it should be noted that vessel-based data was not available for March, April, or May (Table 4.4.7-3).

CONSTRUCTION AND OPERATIONS PLAN

Site Characterization and Assessment of Impacts – Biological Resources

Table 4.4.7-2 Bat Species Detected during Vessel-based Acoustic Surveys for Regional Offshore Wind Projects

Project Location	Vessel/Year	Dates	Metric	Group/Species ^{a/}									Total
				BBSH		HB	RBTB		MYSP			UNKN	
				EPFU	LANO	LACI	LABO	PESU	MYLE	MYLU	MYSE	NoID	
South Fork Wind	Enterprise/2017	July 14 – Nov 15	No. passes	44	116	19	620	31	1	31	34	15	911
			%	4.90	12.90	2.10	69.20	3.50	0.10	3.50	3.80	-	-
	Seacor Supporter/2018	Aug 5– Sept 8	No. passes	16	111	13	1,789	17	0	0	0	5	1,951
			%	0.80	5.70	0.70	91.90	0.90	0.00	0.00	0.00	-	-
	Discovery/2018	Oct 16– Dec 30	No. passes	1	5	1	18	1	0	0	0	2	28
			%	3.80	19.20	3.80	69.20	3.80	0.00	0.00	0.00	-	-
Conti/2019	Jan 10– Feb 15	No. passes	-	-	-	-	-	-	-	-	-	-	
		%	-	-	-	-	-	-	-	-	-	-	
Revolution Wind	Discovery/2019-2020	June 12– Jan 21	No. passes	40	113	4	80	4	0	0	0	68	309
			%	16.60	46.90	1.70	33.20	1.70	0.00	0.00	0.00	-	-
Sunrise Wind Farm Project	Discovery/2019-2020	June 18– Jan 21	No. passes	4	14	4	40	2	0	0	0	14	78
			%	6.30	21.90	6.30	62.50	3.10	0.00	0.00	0.00	-	-
	Enterprise/2019	Oct 10– Nov 4	No. passes	7	9	1	9	1	0	0	0	15	42
			%	25.90	33.30	3.70	33.30	3.70	0.00	0.00	0.00	-	-
	Searcher/2019	Oct 10– Nov 8	No. passes	29	26	0	5	0	0	0	0	38	98
			%	48.30	43.30	0.00	8.30	0.00	0.00	0.00	0.00	-	-

SOURCES:

Stantec 2018a, 2019a,b,c, 2020a,b,c

NOTES:

^{a/} Group/Species: BBSH = big brown bat (EPFU) and silver-haired bat (LANO); HB = hoary bat (LACI); RBTB = eastern red bat (LABO) and tri-colored bat (PESU); MYSP = little brown bat (MYLU), northern long-eared bat (MYSE), and eastern small-footed bat (MYLE); and UNKN = unknown species passes labeled as “NoID” by Kaleidoscope software.

CONSTRUCTION AND OPERATIONS PLAN

Site Characterization and Assessment of Impacts – Biological Resources

Table 4.4.7-3 Monthly Timing of Calls during Vessel-based Acoustic Surveys for Regional Offshore Wind Projects

Project Location	Vessel/Year	Month	Dates Deployed	Calendar Nights ^{a/}	Detector Nights ^{b/}	Recorded Passes	Detection Rate ^{c/}	Maximum Passes Recorded in a Detector Night ^{d/}
South Fork Wind	Enterprise/2017	July	July 14–31	18	18	7	0.4	3
		August	August 1–31	31	31	534	17.2	190
		September	September 1–30	30	30	274	9.1	116
		October	October 1–31	31	31	91	2.9	44
		November	November 1–15	15	15	5	0.3	3
	Seacor Supporter/2018	August	August 5–31	27	27	1,883	69.7	789
		September	September 1–8	8	8	68	8.5	35
	Discovery/2018	October	October 16–31	7	7	23	3.3	13
		November	November 1–30	21	19	5	0.3	2
		December	December 1–30	22	21	0	0	0
	Conti/2019	January	January 10–31	14	14	0	0	0
February		February 1–15	5	5	0	0	0	
Revolution Wind	Discovery/2019-2020	June	June 12–30	14	14	0	0	0
		July	July 1–31	30	30	6	0.2	4
		August	August 1–31	30	30	56	1.9	14
		September	September 1–30	26	26	76	2.9	26
		October	October 1–30	24	24	171	7.1	142
		November	November 2–30	22	22	0	0	0
		December	December 1–29	19	19	0	0	0
		January	January 2–21	11	11	0	0	0

CONSTRUCTION AND OPERATIONS PLAN

Site Characterization and Assessment of Impacts – Biological Resources

Project Location	Vessel/Year	Month	Dates Deployed	Calendar Nights ^{a/}	Detector Nights ^{b/}	Recorded Passes	Detection Rate ^{c/}	Maximum Passes Recorded in a Detector Night ^{d/}
Sunrise Wind Farm Project	Discovery/2019-2020	June	June 18–30	8	8	0	0	0
		July	July 1–31	21	21	2	0.1	2
		August	August 4–31	20	20	44	2.2	14
		September	September 1–30	24	24	32	1.3	11
		October	October 3–13	6	6	0	0	0
		November	November 4–30	18	18	0	0	0
		December	December 1–27	16	16	0	0	0
		January	January 1–21	9	9	0	0	0
	Enterprise/2019	October	October 10–31	22	22	36	1.6	16
		November	November 1–4	4	4	6	1.5	5
	Searcher/2019	October	October 10–31	22	22	98	4.5	61
		November	November 1–8	8	8	0	0.0	0

NOTES:

^{a/} Number of calendar nights that vessel was within study area.

^{b/} One detector-night is equal to one detector successfully operating for at least a portion of the night.

^{c/} Number of bat passes recorded per detector-night.

^{d/} Maximum number of bat passes recorded in a detector-night.

Sources: Stantec 2018a, 2019a,b,c, 2020a,b,c

CONSTRUCTION AND OPERATIONS PLAN

Site Characterization and Assessment of Impacts – Biological Resources

The following subsections summarize species composition and timing of occurrence offshore by bat type (cave-hibernating or migratory tree bat).

Cave-hibernating Bats

Species Composition

Five species of cave-hibernating bat were detected offshore during recent vessel-based acoustic bat surveys for South Fork Wind, Revolution Wind, and the Project: big brown bat (*Eptesicus fuscus*), tri-colored bat (*Perimyotis subflavus*), eastern small-footed bat (*Myotis leibii*), little brown bat (*Myotis lucifugus*), and northern long-eared bat. Two of these species were detected within the SRWF: big brown bat and tri-colored bat (Table 4.4.7-2). There are limitations to positive identification of some *Myotis* species' calls, particularly northern long-eared bat and little brown bats, due to overlapping call signatures between similar species.

At the South Fork Wind Farm, there was a single northern long-eared bat call detected in the offshore project area during the 2017 Enterprise vessel-based survey; the detection was recorded 21.1 mi (18.3 nm, 34 km) offshore from the closest point of land [Block Island] (Stantec 2018a). Other northern long-eared bat passes (n=33) detected during the 2017 survey were between 3.1 and 8.7 mi (2.7–7.6 nm, 5–14 km) offshore (Stantec 2018a). During the 2017 survey, there were no other *Myotis* detected in the offshore Project Area; however, there was one little brown bat and one eastern small-footed bat pass detected approximately 5 mi (4.3 nm, 8 km) west of South Fork Wind offshore project area (and approximately 15 mi [13 nm, 24 km] off of Block Island); the other detections of *Myotis* were closer to shore (Stantec 2018a; Figure 4.4.7-2). None of the other recent vessel-based acoustic surveys for South Fork Wind, Revolution Wind, or the Project documented *Myotis* species (Table 4.4.7-2).

During vessel-based surveys at the construction site of Block Island Wind, of the 1,307 passes identified to species, 1 pass was labeled as a big brown bat and no passes were identified as *Myotis* species (Stantec 2016a). Stationary acoustic detectors positioned on two WTGs at the now operational Block Island Wind recorded 1,086 bat passes that could be identified to species; of these, big brown bats and tri-colored bats each accounted for 3 percent (n = 33), two passes were labeled as little brown bat (<1 percent), and no passes (0 percent) were identified as eastern small-footed bat or northern long-eared bat (Stantec 2018b). During three years of post-construction acoustic monitoring at Block Island Wind Farm from August 2017 – February 2020, among those passes that could be identified to species, 6.8% (n=135) were big brown bats and 4.1% (n=80) were tri-colored bats. There were two little brown bats recorded, representing 0.1% of passes that could be identified to species (Stantec 2018a; Stantec 2020d).

In summary, cave hibernating bats do occur offshore though relatively infrequently. Offshore movements of *Myotis* are rare, particularly for northern long-eared bats. Cave-dwelling bat activity is greater onshore and at coastal locations compared to offshore (Smith and McWilliams 2016; NPS 2018; Stantec 2018a, 2019a,b, 2020a,b,c).

This page intentionally left blank

V:\1956\active_Task Owner and other Non-BC1956_Jobs\2028113199\03_data\gis_cad\gis\Map\XDC\COP\2028113199_4.4.7-2_BatDetections.mxd Revised: 2021-05-07 By: gcarper/ler

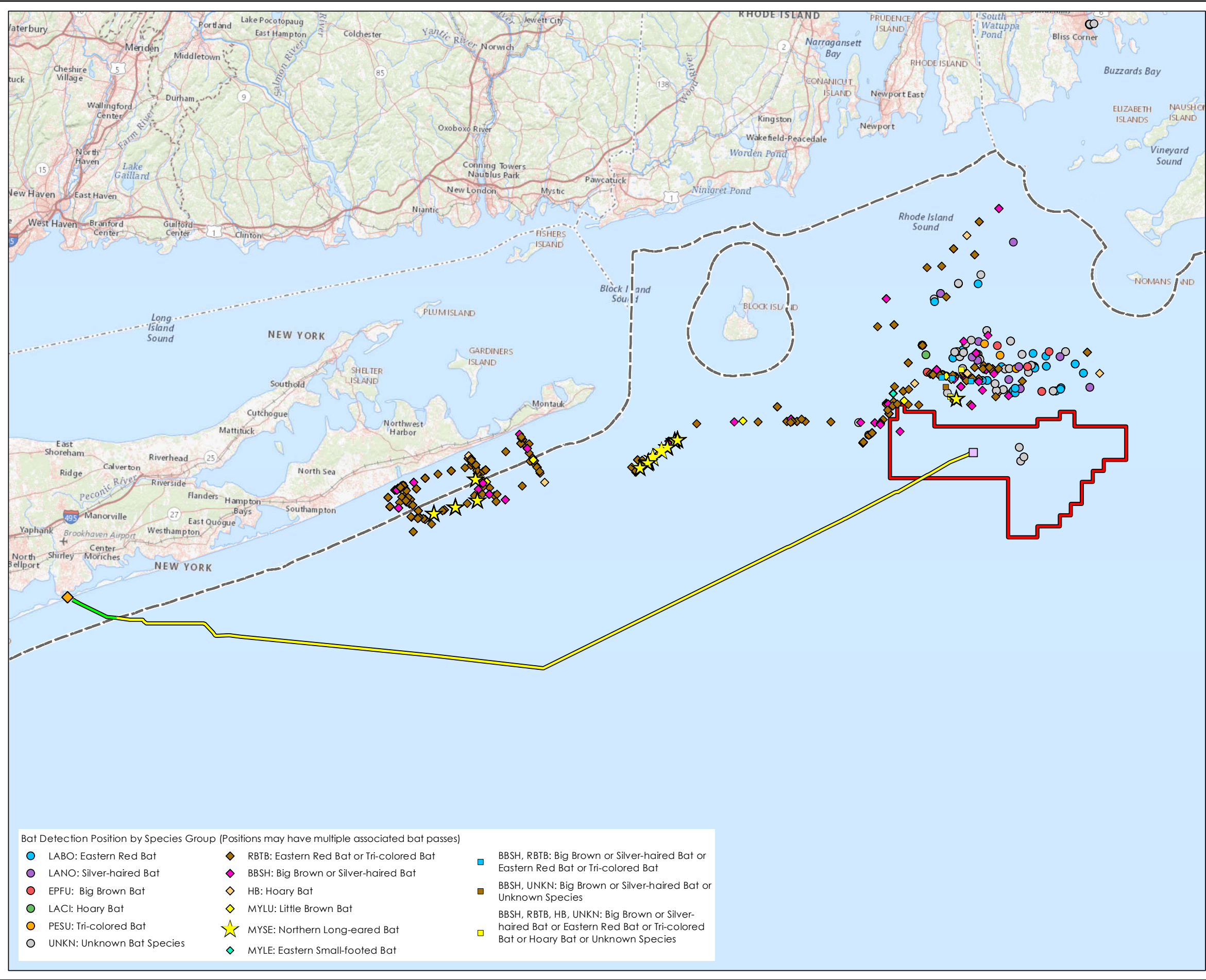

Figure 4.4.7-2
Locations of Bat Detections
(Vessel Positions) during Regional
Vessel-Based Acoustic Bat Surveys

Sunrise Wind | Powered by **Ørsted & Eversource**

- Legend**
- Sunrise Wind Farm
 - Offshore Converter Station (OCS-DC)
 - ◆ SRWEC Landfall Location
 - Sunrise Wind Export Cable (SRWEC-OCS)
 - Sunrise Wind Export Cable (SRWEC-NYS)
 - 3-nm State Waters Boundary

Notes
 For details regarding survey methods, locations and level of effort, refer to the references listed in Sources

Sources
 SFWF: Stantec 2018, Stantec 2019a, b, c; SRWF: Stantec 2020a; Revolution WF: Stantec 2020b
 Base Map: USGS The National Map

Date	09/01/2020 Revised: 12/18/2020
Project Number	2028113199
Prepared By	GC
Reviewed By	LJ

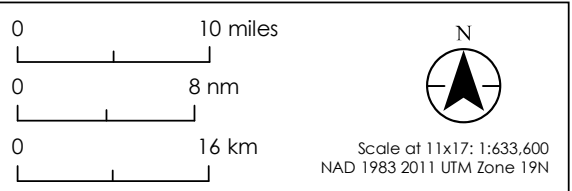

- Bat Detection Position by Species Group (Positions may have multiple associated bat passes)**
- | | | |
|--|--|--|
| <ul style="list-style-type: none"> ● LABO: Eastern Red Bat ● LANO: Silver-haired Bat ● EPFU: Big Brown Bat ● LACI: Hoary Bat ● PESU: Tri-colored Bat ● UNKN: Unknown Bat Species | <ul style="list-style-type: none"> ◆ RBTB: Eastern Red Bat or Tri-colored Bat ◆ BBSH: Big Brown or Silver-haired Bat ◆ HB: Hoary Bat ◆ MYLU: Little Brown Bat ★ MYSE: Northern Long-eared Bat ◆ MYLE: Eastern Small-footed Bat | <ul style="list-style-type: none"> ■ BBSH, RBTB: Big Brown or Silver-haired Bat or Eastern Red Bat or Tri-colored Bat ■ BBSH, UNKN: Big Brown or Silver-haired Bat or Unknown Species ■ BBSH, RBTB, HB, UNKN: Big Brown or Silver-haired Bat or Eastern Red Bat or Tri-colored Bat or Hoary Bat or Unknown Species |
|--|--|--|

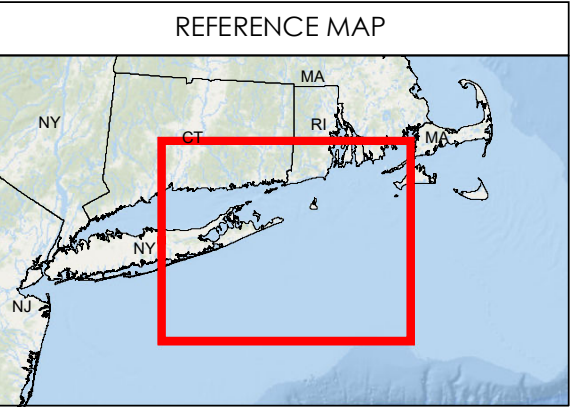

This page intentionally left blank

CONSTRUCTION AND OPERATIONS PLAN

Site Characterization and Assessment of Impacts – Biological Resources

Seasonal Occurrence

Available information suggests that cave-hibernating bats occur offshore primarily in the late-summer and fall (Stantec 2018a, 2019a,b) but relatively infrequently compared to migratory tree bats (Table 4.4.7-2).

Cave dwelling bats were primarily detected during the months of August through October during 2017 to 2019 regional vessel-based acoustic surveys (Stantec 2018a, 2019a,b, 2020a,b,c) (Table 4.4.7-3). There are no regional vessel-based data available for March, April, or May when some bat activity may occur offshore; however, based on other regional studies that did cover spring periods, relatively less bat activity is expected offshore in the spring (Peterson et al. 2014; Stantec 2016b). There were no bats detected during the months of December, January, or February, based on the regional vessel-based data (Table 4.4.7-3) suggesting bats would have no exposure to the SRWF during these months.

Myotis were only recorded during the 2017 Enterprise study for South Fork Wind. Of the northern long-eared passes detected during vessel-based surveys for South Fork Wind (Figure 4.4.7-2), most occurred during two nights in August (9 passes recorded on the night of August 13 and 23 passes recorded on the night of August 20). During these nights, the ship was positioned approximately 3 to 9 mi (3–8 nm, 5–14 km) southeast of the eastern tip of Long Island. A single call identified as a northern long-eared bat was detected during the night of August 5, when the ship was approximately 21 mi (18 nm, 34 km) southeast of Block Island (Stantec 2018a).

Other Myotis (all little brown bats with the exception of one eastern small-footed bat) were detected in August (n=17), September (n=14), and October (n=1) (Stantec 2018a). During three years of post-construction acoustic monitoring at Block Island from August 2017 – February 2020, of the relatively few cave-hibernating species recorded at the WTGs—for big browns and tri-colored bats combined—88 bat passes were detected in August, 118 bat passes were detected in September, and seven bat passes were detected in October; the two little brown bat passes were detected in September 2017. No cave-hibernating species were detected outside of the August–October period (Stantec 2018a; Stantec 2020d). These results are consistent with timing of peak bat activity periods detected at other regional sites and suggests cave-dwelling bats may be at some risk of exposure to offshore wind development in August through October.

Biodiversity Works documented northern long-eared bat summer maternity colonies in 2015 on Martha's Vineyard (which is located approximately 20 mi [32.2 km] north of the SRWF). Survey data suggested that northern long-eared bats may overwinter in hibernacula on the island or may possibly migrate from the island to mainland hibernacula in August and September, though none of the five northern long-eared bats tracked during this study were detected making offshore movements (Dowling et al. 2017). A 2016 nanotag tracking study on Martha's Vineyard recorded little brown bat (n=3) movements off the island in late August and early September, with one individual documented flying from Martha's Vineyard to Cape Cod (Dowling et al. 2017).

Big brown bats (n=2) were also detected migrating from the island in October and November (Dowling et al. 2017). This study further demonstrates cave-dwelling bat dispersal movements occur offshore in the late-summer and fall.

CONSTRUCTION AND OPERATIONS PLAN

Site Characterization and Assessment of Impacts – Biological Resources

Available data suggests cave-dwelling bats may be at some risk of exposure to offshore wind development during summer and fall dispersal periods. There were no bats detected during the months of December, January, or February based on the regional vessel-based data suggesting bats would have no exposure to the SRWF during these months. Based on cave-dwelling bat habitat requirements in the summer and winter, cave-dwelling bat activity is not expected in the SRWF outside of dispersal periods to and from mainland hibernacula.

Cave-hibernating bats that spend the entire year on islands such as Martha's Vineyard would not be expected to make offshore movements. At the South Fork Wind Farm, there was a single northern long-eared bat call detected in the offshore project area during the 2017 Enterprise vessel-based survey; the detection was recorded 21.1 mi (18.2 nm, 33.8 km) offshore from the closest point of land (Stantec 2018a) (Figure 4.4.7-2). None of the other recent vessel-based acoustic surveys in the vicinity of the SRWF (which covered late-summer and fall dispersal periods) documented northern long-eared bat. Therefore, occurrences of northern long-eared bat in the SRWF are expected to be very rare. Cave-dwelling bat activity is greater onshore and at coastal locations compared to offshore (Smith and McWilliams 2016; NPS 2018; Stantec 2018a, 2019a,b, 2020a,b,c).

Migratory Tree Bats

Species Composition

All three species of migratory tree bat (hoary bat, eastern red bat, and silver-haired bat) were detected during all of the vessel-based acoustic surveys for South Fork Wind, Revolution Wind, and the Project, with the exception of the South Fork Conti vessel-based winter survey, which detected no bat passes (Stantec 2018a, 2019a,b,c, 2020a,b,c; Table 4.4.7-2). Migratory tree bats represent the bat group most frequently detected among these vessel-based surveys, with eastern red bat representing between 8.3 and 91.9 percent of all species of bat passes recorded among each of the vessel-based surveys (Table 4.4.7-2).

During vessel-based surveys at the construction site of Block Island Wind, tree roosting species were most frequently detected: of the 1,307 passes identified to species, eastern red bats accounted for 90 percent (n=1,180), hoary bats accounted for 9 percent (n=112), and silver-haired accounted for 1 percent (n=14) (Stantec 2016a). During three years of post-construction monitoring at the Block Island Wind Farm from August 2017 through February 2020, of the 1,974 passes identified to species, eastern red bats accounted for 41.4% (n = 818), silver-haired bats accounted for 35.1% (n = 692), and hoary bats accounted for 12.5% (n = 247) (Stantec 2018a; Stantec 2020d).

Seasonal Occurrence

Table 4.4.7-3 provides the peak periods of bat detection during vessel-based surveys; and as depicted in Table 4.4.7-2, the majority of bats species recorded were migratory tree bats. During the 2017 Enterprise vessel-based acoustic survey at South Fork, tree bats were primarily detected in August (n=363) and September (n=308), but also July (n=6), October (n=74), and November (n=4) (Stantec 2018a). There were similar results detected during the 2018 Seacor Supporter survey, which overlapped with late summer: the majority of tree bat passes were detected in August (Stantec 2019a,b).

CONSTRUCTION AND OPERATIONS PLAN

Site Characterization and Assessment of Impacts – Biological Resources

During three years of post-construction monitoring at the Block Island Wind Farm from August 2017 to early February 2020—for all tree roosting species combined—there were two detections in May, two detections in June, six detections in July, 712 detections in August, 955 detections in September, 102 detections in October, and four in November; there were no bat detections from December through April recorded during post-construction surveys at the Block Island Wind Farm (Stantec 2018a; Stantec 2020d).

Available information suggests that migratory tree bats represent the species that occur relatively most frequently offshore, with peak timing of occurrence offshore in the late-summer and fall. Bat activity is greater onshore and at coastal locations compared to offshore (Smith and McWilliams 2016; NPS 2018; Stantec 2018a, 2019a,b, 2020a,b,c). Acoustic surveys conducted onshore at Rhode Island National Wildlife Refuge Complex reported greater numbers of passes of bats compared to those detected during offshore studies (Smith and McWilliams 2016; Stantec 2018a, 2019a,b), and acoustic surveys conducted at both offshore and coastal sites in the Gulf of Maine, mid-Atlantic, and Great Lakes reported greater activity levels of bats at coastal sites compared to offshore sites (Stantec 2016b). Available data suggests migratory tree bats may be at risk of exposure to offshore wind development during summer and fall migratory periods.

There were no bats detected during the months of December, January, or February based on the regional vessel-based data suggesting bats would have no exposure to the SRWF during these months. Based on migratory tree bat habitat requirements in the summer and winter, little to no activity is expected in the SRWF outside of migratory periods.

Sunrise Wind Export Cable

Similar to the SRWF, bats (primarily migratory tree roosting species) are generally expected to occur in the SRWEC–OCS only during migratory periods, particularly in August and September. Similar species composition, timing of occurrence, and behaviors (e.g., migrating, potential foraging) expected in the SRWF would also be expected in the SRWEC–OCS and SRWEC–NYS. Available information for both migratory tree bats and cave-hibernating bats suggests that activity is likely to increase with proximity to shore (Peterson et al. 2014; Stantec 2016b). See section above on the SRWF and Appendix P for additional details on bat occurrence offshore.

Onshore Facilities

Terrestrial habitats associated with the Onshore Facilities may provide summer roosting, pup-rearing (i.e., caring for young), and foraging habitat for bats, including species such as big brown bats, little brown bats, and tri-colored bats; these species will also roost in man-made structures such as attics or barns (BCI 2001). The pup-rearing season for these species of bats is typically May through July (Kunz 1982; Shump and Shump 1982a, 1982b) but may be longer in this region based on discussions with NYSDEC. Terrestrial habitats associated with the Onshore Facilities may provide summer roosting, pup-rearing (i.e., caring for young), and foraging habitat for the state and federally threatened northern long-eared bat. According to the most recent (2020) USFWS Summer Bat Survey Guidelines (Guidelines), suitable summer habitat for northern long-eared bat consists of a wide variety of forest types where they roost, forage, and travel, and may also include some adjacent and interspersed non-forested habitats such as emergent wetlands and adjacent edges of agricultural fields, old fields, and pastures (USFWS 2020e).

CONSTRUCTION AND OPERATIONS PLAN

Site Characterization and Assessment of Impacts – Biological Resources

There are several fragmented forested locations within the corridor for the Onshore Facilities that may provide summer habitat for bats, including the forested swamp areas along the Carmans River and forested areas along Victory Avenue and Horseblock Road and north of Union Avenue. For northern long-eared bats, summer roosting habitat is typically occupied from mid-May through mid-August each year; the pup-rearing season (i.e., when young are birthed and raised by females in maternity roosts) extends from early June through the end of July (USFWS 2020).

The NYNHP identified presence of the northern long-eared bat, specifically maternity roosts and other summer locations, at several locations within 0.5 mi (0.4 nm, 0.8 km) of the Onshore Transmission Cable and additional locations within 1.5 mi (1.3 nm, 2.4 km) (NYNHP 2020). According to the NYNHP, individuals may travel 1.5 mi (1.3 nm, 2.4 km) or more from documented roost locations (NYNHP 2020). The official species list generated from the IPaC database also indicated that northern long-eared bat has the potential to occur within the Onshore Facilities (USFWS 2020b). As a follow-up to an April 24, 2020, agency meeting, NYSDEC indicated that several areas along the Onshore Transmission Cable route have had acoustic detections for northern long-eared bat and there are roost trees documented within the Wertheim National Wildlife Refuge, which is located to the south of the Onshore Transmission Cable and is approximately 1 mi (0.9 nm, 1.6 km) from the Landfall Work Area (K. Gaidasz, NYSDEC, email comm.). No critical habitat has been designated for northern long-eared bat (USFWS 2020b) and there are no known hibernacula in the vicinity of the Project (NYNHP 2020).

During a July 2018 mist-netting, telemetry, and roost study on County park lands in Suffolk County, Long Island, the closest location (out of four study locations) to the Onshore Facilities was the Terrell River County Park, approximately 5 mi (4 nm, 8 km) east of the Onshore Transmission Cable (Stantec 2018c; Figure 4.4.7-1). At this study location, big brown bats and eastern red bats were the two species captured (Stantec 2018c). Of the four study locations, northern long-eared bats (n=2) were only captured at Indian Island County Park, approximately 17 mi (15 nm, 27 km) east of the Onshore Facilities, where they were tracked to multiple roost tree locations within the park (Stantec 2018c).

The NPS is coordinating an ongoing mist-netting and acoustic bat survey at FINS including the unit at the William Floyd Estate on Long Island, which is within 2 mi (1.7 nm, 3.2 km) of the Onshore Transmission Cable route and 2.5 mi (2.2 nm, 4 km) of the Landfall Work Area. To-date there have been seven species of bats detected from April through October on Fire Island and at the William Floyd Estate, including both cave-dwelling (big brown bat, eastern small-footed bat, northern long-eared bat, and tri-colored bat) and migratory bats (eastern red bat, hoary bat, and silver-haired bat) (NPS 2018, 2020). In 2015, 12 northern-long eared bats were captured at the William Floyd Estate, and in 2017, 2018, and 2019, northern long-eared bats were detected during acoustic surveys (NPS 2019, 2020). In 2018, northern-long eared bats were observed to be reproducing at the William Floyd Estate (NPS 2018). In 2015, northern long-eared bats were observed to be reproducing at Wertheim National Wildlife Refuge (USFWS 2016).

CONSTRUCTION AND OPERATIONS PLAN

Site Characterization and Assessment of Impacts – Biological Resources

4.4.7.2 Potential Impacts

Construction, O&M, and decommissioning activities associated with the SRWF, SRWEC, and Onshore Facilities have the potential to cause both direct and indirect impacts to bat species; impacts may be short-term or long-term. IPFs associated with the construction and O&M phases of the Project are identified on Figure 4.4.7-3 and described separately, by phase, for the SRWF, SRWEC, and Onshore Facilities in the following sections. For the decommissioning phase of the Project, impacts are anticipated to be similar to or less adverse than those described for construction; therefore, impacts from decommissioning are not addressed separately in this section. Supporting information on impacts to bat species are also presented in further detail in Appendix P.

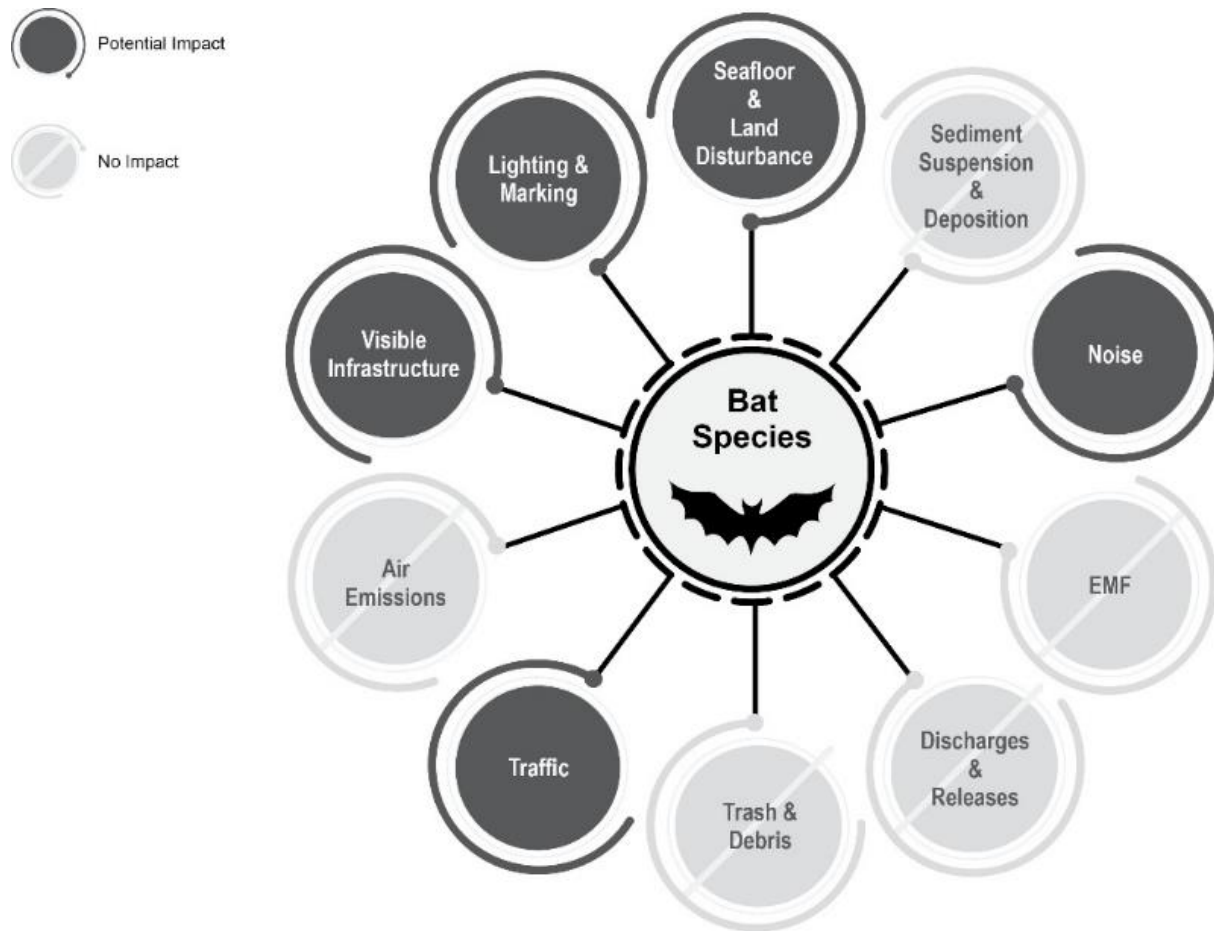

Figure 4.4.7-3 Impact-Producing Factors on Bat Species

CONSTRUCTION AND OPERATIONS PLAN

Site Characterization and Assessment of Impacts – Biological Resources

Sunrise Wind Farm

The IPFs associated with the SRWF that could directly and indirectly impact bat species include visible infrastructure and lighting during construction and O&M. The potential impacts associated with these IPFs for each phase of the SRWF are addressed separately in the following sections, and more detailed information is presented in Appendix P. Temporary vessel traffic and noise associated with construction are not expected to substantially disturb bats because, if bats do occur in the SRWF, they would be passing overhead. Since bats typically forage for insects in flight, no impacts to bats from discharges or releases at the SRWF are expected.

Construction

Visible Infrastructure

Bats may seasonally occur in the airspace above the SRWF while migrating. Available information from onshore wind projects suggests that bats are more likely to be attracted to wind farm structures than to be displaced by them (Cryan et al. 2014). Bats may be attracted to support vessels, equipment, or components of the WTGs or OCS–DC while under construction. Visible structures on a previously flat, unusable landscape may provide potential roosting opportunities to bats during migratory movements offshore, which could represent a benefit during construction (however, it may pose a risk of collision during O&M). Bats were observed roosting on support vessels during construction of Block Island Wind (Stantec 2016a) as well as roosting on G&G vessels (Stantec unpubl.), and studies from European offshore wind projects indicate that bats may take advantage of artificial roosting structures, if available (Ahlén 2006; Ahlén et al. 2007, 2009; Hutterer et al. 2005). As such, visible structures may benefit instead of adversely impact bats during construction. Collision-related impacts are unlikely during construction because bats are expected to typically detect stationary structures or slow-moving vessels.

Lighting

Nighttime lighting at construction areas may attract insect prey and, therefore, indirectly attract bats to forage, providing a potential benefit to bats during construction. It is possible bats would benefit from artificial roosting structures and foraging opportunities if insect prey were to be attracted to artificial lighting in terms of energy conservation if migrating offshore. Similar to visible structures, lighting during construction may benefit instead of adversely impact bats.

Operations and Maintenance

During O&M, visible structures and lighting may represent IPFs to bats in the form of both direct and indirect effects. Potential attraction of bats to SRWF components during O&M may increase bat risk of collision due to the presence of spinning blades, potentially resulting in injury or mortality. Additional details on potential impacts from these IPFs during O&M are described in the following sections.

CONSTRUCTION AND OPERATIONS PLAN

Site Characterization and Assessment of Impacts – Biological Resources

Visible Infrastructure

Visible infrastructure (including WTG and OCS–DC structures) on a previously flat and unusable landscape may provide potential roosting opportunities to bats during movements offshore. During construction of the WTGs at Block Island Wind, crew members from the construction vessels made multiple observations of bats roosting on construction vessels during the day (Stantec 2016b). Similar to vessels at sea, offshore structures may provide potential roosting platforms and may benefit exhausted bats during long-distance migration. It is possible bats would benefit from stationary roosting structures in terms of energy conservation if migrating offshore; however, attraction behaviors may increase risk of collision during O&M due to blade rotation.

Bat mortality is known to occur at terrestrial wind farms in the US (Arnett et al. 2008; Cryan and Barclay 2009; Hayes 2013; Smallwood 2013; Martin et al. 2017; NYSERDA 2017a; Pettit and O’Keefe 2017; Allison et al. 2019). These fatalities, which predominantly involve migratory tree-roosting bats (Kunz et al. 2007), primarily occur during peak activity period for bats in late summer (Arnett et al. 2008). Long-distance migrants such as eastern red bat, hoary bat, and silver-haired bat have represented most fatalities at onshore wind projects in North America; however, other non-migratory species such as *Myotis* (including the federally threatened northern long-eared bat), big brown bat, and tri-colored bat have been documented during onshore fatality surveys as well (Kunz et al. 2007; Gruver and Bishop-Boros 2015).

There is some evidence from Europe to suggest that bats foraging low (< 10 m [32.8 ft]) over the surface of the ocean increase their altitude when foraging around obstacles (i.e., lighthouses and WTGs), thus potentially increasing exposure to turbine blades (Ahlén et al. 2009). While bats can generally detect stationary structures, they are not necessarily aware of moving blades. Bats may seasonally occur in the SRWF while migrating but their use of onshore and nearshore environments is known to be relatively much greater than their use of offshore environments, as demonstrated by acoustic detection data collected offshore and onshore (Smith and McWilliams 2016; NPS 2018; Stantec 2016b, 2018a,b, 2019a,b, 2020a,b,c; Appendix P).

Some evidence exists of bats visiting WTGs close to shore (2.5–4.3 mi [2.2–3.7 nm, 4–6.9 km]) in the Baltic Sea (Ahlén et al. 2009; Rydell and Wickman 2015), and bats may be vulnerable to collisions with offshore WTGs. However, a relatively low level of bat activity is expected at SRWF because of its distance from shore. While there may be individual bat fatalities resulting from operation of the WTGs, the SRWF is unlikely to impact bat populations. As demonstrated by regional acoustic surveys, it is unlikely that northern long-eared bats will occur within the SRWF; therefore, the SRWF is unlikely to affect northern long-eared bats. The indirect impacts to bats due to attraction to visible structures during O&M are, therefore, considered long-term but minimal due to the SRWF distance to shore and the relatively low use of bats of offshore environments, particularly for rare bat species as demonstrated during the regional vessel-based acoustic bat surveys (Stantec 2018a, 2019a,b,c, 2020a,b,c).

CONSTRUCTION AND OPERATIONS PLAN

Site Characterization and Assessment of Impacts – Biological Resources

Due to the operational cut-in and cut-out wind speed limitations, the WTGs may not be operating approximately 2 to 3 percent of the time during winter months, approximately 2 to 4 percent of the time during spring and fall months, and approximately 3 to 5 percent of the time during summer months. Bats would be at little to no risk of collision when the blades are not spinning (and they would be expected to detect WTG stationary structures and generally avoid collision with them).

Lighting

Nighttime lighting on the WTG decks and OCS–DC may attract insect prey and, therefore, indirectly attract bats to forage. The WTGs will be lit with navigation and aviation lighting; however, aviation lighting has not been found to influence bat collision risk at onshore facilities in North America (Arnett et al. 2008).

In general, bats are not expected to regularly commute (transit between roosting and foraging areas) or forage at the SRWF, but some may be present during migration, particularly in the late-summer and fall (Stantec 2018a, 2019a,b,c, 2020a,b,c). The exposure of cave-hibernating bats to SRWF is expected to be minimal to low, and occurrences of northern long-eared bat as far offshore as the SRWF are expected to be very rare (Appendix P); therefore, impacts to populations of cave-hibernating bats during O&M are unlikely. Migratory tree bats have the highest potential to pass through SRWF, but relatively lower numbers are expected given the Project's distance from shore. Therefore, impacts to bats due to attraction to lighting are considered long-term but minimal.

Sunrise Wind Export Cable

It is possible bats would benefit from artificial roosting structures that support vessels may provide while present during construction or maintenance (O&M) of the SRWEC–OCS and SWREC–NYS, in terms of energy conservation. Bats may similarly benefit from increased foraging opportunities if insect prey are attracted to artificial light sources in construction or maintenance areas. Therefore, there are no IPFs expected to adversely impact bats during construction or O&M of the SRWEC–OCS and SRWEC–NYS. Any potential roosting opportunities would only be available if vessels were to be present; therefore, associated effects would be temporary and localized.

Onshore Facilities

The IPFs associated with the Onshore Facilities that could impact bat species include land disturbance, noise, traffic, visible infrastructure, and lighting. The potential impacts associated with these IPFs for each phase of the Onshore Facilities are addressed separately in the following sections, and more detailed information is presented in Appendix P.

Construction

IPFs at the Onshore Facilities during the construction phase may result in mortality or injury from land disturbances, displacement due to noise, displacement or mortality/injury from traffic, or displacement due to visible infrastructure and lighting. Additional details regarding these potential impacts from the various IPFs during construction of the Onshore Facilities are described in the following sections.

CONSTRUCTION AND OPERATIONS PLAN

Site Characterization and Assessment of Impacts – Biological Resources

Land Disturbance

Potential direct impacts to bat species resulting from land disturbance generated by construction of the Onshore Facilities include habitat loss, and potential direct mortality/injury of individuals. Habitat loss is defined as when an area previously supporting wildlife is converted to non-habitat that lacks the natural resources to support occupancy by any species, such as paved areas. The results of habitat evaluations are included in Appendix L.

Construction of the OnCS–DC, Onshore Transmission Cable, and Onshore Interconnection Cable is expected to result in approximately 2.3 acres (0.9 ha) of permanent tree clearing. Sunrise Wind will use mechanical clearing methods for the construction of the Project and does not intend to use any herbicides/pesticides during the construction phase. Therefore, direct (potential exposure to toxins) and indirect (potential impacts to habitat) impacts to bats related to herbicides/pesticides will be avoided during construction.

The OnCS–DC construction in the Town of Brookhaven will require tree and vegetation clearing, potentially including suitable summer roosting habitat. The Union Avenue Site is primarily a developed industrial/commercial site with small narrow forested areas along parcel boundaries, very limited vegetation clearing would be required at this location (Appendix L).

Construction of the OnCS–DC will impact up to 7 acres (2.8 ha); however, the actual footprint will be no more than 6 acres (2.4 ha). The general area in the vicinity of OnCS–DC is largely developed and limited existing suitable summer bat habitat is expected in these areas. This change in the visible landscape presents a minimal change to available habitats in the broader region.

The Onshore Transmission Route/Interconnection Cable is generally located within the paved portion of existing roadway or utility-owned or controlled property and previously disturbed and developed areas to the extent practicable to minimize impacts to natural locations. The duct bank for the Onshore Transmission Cable will be installed via open trench excavation for the majority of the Cable. Terrestrial land cover types adjacent to the Onshore Transmission Cable mainly consists of developed residential or industrial land uses, with the exception of forested wetlands and waterways at the Carmans River crossing (see Appendix L). The Project will utilize trenchless crossing installation to avoid sensitive environmental resources or other physical obstructions (i.e., railroads) at certain crossing locations. The use of trenchless crossings for installation of portions of the Onshore Transmission Cable/Interconnection Cable, such as in the vicinity of the Carmans River, will minimize impacts to terrestrial habitats.

Coastal habitats associated with the Landfall Work Area on Fire Island include foreshore, backshore, dune, and interdunal areas (Appendix L). The Landfall/ICW Work Area occupies a portion of the parking lot at Smith Point County Park on Fire Island, an approximately 425-acre (172-ha) public beach and recreation area.

Suitable summer roosting habitat for bats is not present within beach and intertidal habitats due to the lack of roost trees. The workspaces at the Landfall/ICW Work Area at Smith Point County Park and Smith Point Marina will be located within paved areas of the parking lots or open land used for recreational activities. The use of HDD for installation will minimize impacts to onshore habitats.

CONSTRUCTION AND OPERATIONS PLAN

Site Characterization and Assessment of Impacts – Biological Resources

Early successional habitat in the temporary workspace and access locations will initially revegetate as a grass/forb and herbaceous cover, then will gradually transition to shrub and sapling cover. Habitat loss will be minimal in the Town of Brookhaven area because, in addition to forested areas, the baseline habitat conditions of this general area include developed residential areas, mowed lawns, parking lots, roads, and commercial and industrial areas. The early successional habitat that will replace the cleared areas and temporary workspace locations outside of the operational footprint of infrastructure may not provide the same benefit to bats in terms of roosting and pupping habitat; however, it may provide new foraging opportunities since many species prefer traveling and foraging along edge habitats, such as tree lines, hedgerows, forest edges, and linear water features (Nelson and Gillam 2017; Verboom 1998).

Direct changes in habitat that may affect roosting and foraging opportunities as a result of land disturbance during construction of the Onshore Facilities are considered long-term but localized and minimal, based on the small operational footprint of Onshore Facilities compared to the broader landscape.

Vegetation/tree clearing during construction has the potential to cause mortality or injury to bat individuals that are less mobile (e.g., pups). Impacts resulting in mortality and injury from construction activities will be minimized as the Project will conduct activities consistent with the 4(d) Rule for northern long-eared bat, which prohibits incidental take from tree removal activities within 150 ft (45.7 m) of a known occupied maternity roost tree during the pup-rearing season (June 1 to July 31). To the extent feasible, tree removal for the Onshore Facilities will occur between December 1 and February 28; this timeframe was identified by the NYSDEC specifically for the Project to avoid the northern long-eared bat active period (K. Gaidasz, NYSDEC, email comm.) If tree removal activities cannot be limited to this period, Sunrise Wind will work with state and federal agencies to develop construction monitoring and impact minimization plans or mitigation plans, as appropriate. Further, per the State's *Protective Measures Required for Northern Long-eared Bats When Projects Occur within Occupied Habitat* (Requirements for Projects that Result in a Change of Land Use Within Occupied Habitat; NYSDEC n.d.-b), there will be no cutting of any trees within a 0.25-mi (0.4-km) buffer around a hibernation site (year-round) and no cutting of documented roost trees or any trees within a 150-foot (45.7-m) radius of a documented summer occurrence. As such, direct mortality or injury impacts to bat species as a result of clearing activities and land disturbances during construction are not expected.

Land disturbance may indirectly result in the spread of invasive species and the displacement of individuals. A study that evaluated ways to improve foraging opportunities for bats found that *Myotis* sp. activity was greater near waterways that included native plants and were clear of invasive species (Lintott et al. 2015). Invasive plants can clutter the understory of a forest, suppress native tree regeneration, and physically reduce the amount of unobstructed subcanopy space where many bats prefer to forage (King 2019). However, the spread of invasive plant species will be managed in compliance with state and federal regulations and the Project's ISMP.

In summary, the amount of habitat loss is small relative to the amount of similar habitat that will remain unimpacted in the general region. Therefore, there may only be minimal impacts associated with land disturbance during construction.

CONSTRUCTION AND OPERATIONS PLAN

Site Characterization and Assessment of Impacts – Biological Resources

Noise

Noise resulting from construction activities for the Onshore Facilities may create indirect impacts to bats. There will be some night work however most construction activity for the Onshore Facilities will take place during the day, when bats are in an energy conserving state of torpor (Speakman and Thomas 2003; Geiser 2004).

Where conducted, trenchless installation operations along the Onshore Transmission Cable/ Interconnection Cable will occur continuously to minimize the risk of soil settlement and equipment failures and, therefore, will create noise during nighttime hours as well. To determine bat response to anthropogenic sound, a study evaluated the effect of noise on torpid bats by subjecting them to a series of natural and anthropogenic playback sound files, as well as no recording to serve as a control, while the bats were in torpor; results showed that bats responded most strongly (awoke from torpor) to colony and vegetation noise and most weakly to traffic noise (Luo et al. 2014). The study also indicated that bats can quickly habituate to continuous or repeating noise disturbances (Luo et al. 2014). Another study investigating impacts of anthropogenic noise on bat foraging behavior found that bats avoided areas subjected to loud noises, suggesting foraging areas close to highways and other sources of loud noise are less suitable for foraging bats (Schaub et al. 2008). While there is no study available that describes HDD noise effects on bats, noise from HDD is expected to be similar to highway noise impacts. Noise from HDD and construction traffic noise may disrupt or displace roosting and/or foraging bats if conducted during the bat active season; however, noise impacts would be temporary and localized.

Traffic

Traffic resulting from construction activities for the Onshore Facilities may result in direct impacts to bats in the form of mortality or injury in the rare event that a bat may collide with a moving construction vehicle. The approach of moving vehicles may also temporarily displace bats if present in construction areas. Most construction traffic for the Onshore Facilities will occur during the day while bats are in torpor, outside of the active foraging period between twilight and sunrise. HDD may occur at night during active foraging periods, but this activity is not expected to significantly disrupt bats because the HDD equipment will be stationary. Traffic during construction activities is not expected to pose a significant source of mortality or disturbance, and associated impacts are considered short-term and localized.

Visible Infrastructure

Visible infrastructure present during the Onshore Facilities construction activities will include construction equipment and the OnCS–DC. There is little evidence regarding collision risk of bats with the onshore components of wind farms such as the OnCS–DC, though there are documented bat fatalities in other onshore electric utilities, such as above-ground transmission and powerline corridors (Manville II 2016). Construction equipment and the OnCS–DC present the potential for direct impacts in the form of collision for bats since these structures will be present during active periods for bats.

CONSTRUCTION AND OPERATIONS PLAN

Site Characterization and Assessment of Impacts – Biological Resources

However, these types of man-made structures are already present throughout the developed and residential areas on Long Island, and transmission facilities will be installed underground. Bats use echolocation to navigate by emitting high-frequency sounds and listening for echoes to determine the location of objects (Schnitzler et al. 2003; Potenza 2017). Therefore, bats can avoid obstacles and locate prey and water sources. However, some smooth, vertical surfaces such as glass and metal reflect the bats' high frequency sounds away from the bat, not toward it (Potenza 2017), which may lead to collision resulting in injury or mortality. Construction activities will be short-term and risk of mortality or injury as a result of the presence of Project infrastructure is considered low.

Lighting

Temporary lighting during certain phases of construction of the Onshore Facilities may be required. While most of the onshore construction will occur during the daylight hours, some overnight lighting may occasionally be necessary, including lighting for HDD work. Potential indirect impacts to bats resulting from lighting during some construction activities at the Onshore Facilities may include temporary displacement or attraction of individuals (if insect prey concentrate around light sources), or disruption of normal behavior (e.g., foraging, breeding). In some cases, bright illumination of areas can potentially prevent or reduce foraging activity, causing bats to pass quickly through the lit area or avoid it completely (Polak et al. 2011). Additionally, certain types of lighting can disrupt the composition and abundance of insect prey (Davies et al. 2012), which may in turn reduce foraging opportunities for bats. Most construction activities will occur during the day when bats are in torpor. Therefore, the impacts associated with lighting are considered short-term and minimal.

Operations and Maintenance

IPFs during O&M may result in indirect (disturbance or displacement) or direct (mortality or injury) effects during routine or non-routine maintenance activities. Additional details regarding these potential impacts during O&M of the Onshore Facilities are described in the following sections.

Land Disturbance

The vegetation management requirements for the Project during operations and maintenance are expected to be minimal. IVM practices may include manual cutting, mowing and the prescriptive use of federally-approved and state-registered herbicides to eliminate targeted plant species within the ROW. Sunrise Wind does not intend to use pesticides during operation of the Project. Herbicides would be applied, using federally-approved, NYS-listed herbicides, following all NYS and local regulations and label restrictions; therefore direct (potential exposure to toxins) and indirect (potential impacts to habitat) impacts to bats related to herbicide use during operations and maintenance is expected to be minimal.

CONSTRUCTION AND OPERATIONS PLAN

Site Characterization and Assessment of Impacts – Biological Resources

Noise

During O&M, the proposed OnCS–DC would introduce new sources of sound including transformers, shunt reactors, harmonic filters, and cooling, and ventilation associated with the valve hall. Temporary noise may occasionally be generated due to routine and non-routine maintenance during O&M. As discussed in the Onshore Facilities construction section above, bat responses to anthropogenic sound suggest that traffic noise is less disturbing to torpid bats than colony or vegetation noise (Luo et al. 2014); therefore, bats may quickly habituate to prolonged noise disturbances. Noise could potentially cause temporary avoidance behavior and/or displacement of bat species; however, most noise impacts would be short-term. Some sources of noise at the OnCS–DC will be long-term and repeated/continuous, but risk of impacts associated with noise is considered minimal.

Traffic

Traffic will occasionally occur in association with routine and non-routine maintenance at the Onshore Facilities. Impacts associated with moving maintenance vehicles may include temporary displacement of bat species from sites undergoing maintenance activities. Traffic may also result in mortality/injury in the rare event that a bat were to collide with a moving maintenance vehicle. However, most maintenance activities are anticipated to occur during daylight periods when bats are inactive; therefore, the short-term risk of impacts due to traffic is considered minimal.

Visible Infrastructure

As indicated in the construction section above, the OnCS–DC will be visible above-ground infrastructure. This change in the landscape presents a low likelihood of mortality or injury due to the ability of bats to generally detect and avoid collision with stationary structures. This risk of collision mortality or injury is considered long-term but minimal. The Onshore Transmission Cable to the existing Holbrook Substation will be buried; therefore, collision with overhead lines will not occur.

Bats may be attracted to the OnCS–DC for roosting opportunities as some species, including big brown bats, often take advantage of man-made structures. It is expected that access to the interior of the OnCS–DC will be prevented, potentially by the use of screens or similar measures; therefore, the risk of impacts associated with bats being attracted to the OnCS–DC for roosting opportunities will be long-term but minimal.

Lighting

During the operation and maintenance of the OnCS–DC, general yard lighting will be used within the OnCS–DC for assessment of equipment. As during construction of the Onshore Facilities, lighting at night has the potential to temporarily displace or indirectly attract bats if insect prey concentrates near lighting—either behavioral response represents a disruption of normal behavior. However, nighttime lighting will be limited to periods when O&M activities occur and is expected to be infrequent. Since the use of lighting at night is expected to be limited, the potential for temporary bat displacement and/or other behavioral changes is considered a long-term effect but minimal impact.

CONSTRUCTION AND OPERATIONS PLAN

Site Characterization and Assessment of Impacts – Biological Resources

4.4.7.3 Proposed Environmental Protection Measures

Sunrise Wind will implement the following environmental protection measures to reduce potential impacts on bat species. These measures are based on protocols and procedures successfully implemented for similar offshore projects.

- Sunrise Wind is committed to an indicative layout scenario with WTGs and the OCS–DC sited in a uniform east-west/north-south grid with 1.15 by 1.15-mi (1 by 1-nm; 1.85 by 1.85-km) spacing that aligns with other proposed adjacent offshore wind projects in the RI-MA WEA and MA WEA. This wide spacing of WTGs may reduce risk of barrier effects and/or displacement, and may allow bats to avoid individual WTGs and minimize risk of potential collision. The WTGs will have an air gap from MSL to minimum blade swept height of 98 to 180 ft (30 to 55 m); bats crossing the area within this height range would not be at risk of collision with spinning blades.
- The distance of the SRWF offshore (greater than 15 mi [13 nm, 24.1 km]) avoids coastal and nearshore areas where bats typically occur.
- Construction and operational lighting will be limited to the minimum necessary to ensure safety and compliance with applicable regulations. Limiting lighting to that which is required for safety and compliance with applicable regulations is expected to minimize impacts on bats.
- Sunrise Wind will use ADLS or related means (e.g., dimming or shielding) to limit visual impact, pursuant to approval by the FAA and BOEM, commercial and technical feasibility at the time of FDR/FIR approval, and dialogue with stakeholders. In addition to limiting visual impact, reducing lighting will also reduce the potential for impacts to bats.
- Accidental spill or release of oils or other hazardous materials will be managed offshore through an ERP/OSRP and onshore through an SPCC Plan.
- Onshore Facilities are primarily sited within previously disturbed and developed areas (e.g., roadways, ROWs, developed industrial/commercial areas) to the extent feasible, to minimize impacts to undisturbed bat habitat.
- An ISMP will be implemented to manage the spread of invasive plant species that could negatively impact native plants and bat habitat.
- Sunrise Wind will document any dead (or injured) bats found incidentally on vessels and structures during construction, O&M, and decommissioning and provide an annual report to BOEM and USFWS.
- Time-of-year restrictions for certain work activities such as tree removal will be employed to the extent feasible to avoid or minimize direct impacts to northern long-eared bats during construction of the Onshore Facilities. If work is anticipated to occur outside of this period, Sunrise Wind will work with state and federal agencies to develop construction monitoring and impact minimization plans or mitigation plans, as appropriate.
- The Onshore Transmission Cable and Onshore Interconnection Cable will not include any overhead utility poles, thus minimizing potential impacts to bats associated with overhead lines.

CONSTRUCTION AND OPERATIONS PLAN

Site Characterization and Assessment of Impacts – Visual Resources

4.5 Visual Resources

4.5.1 Visual Resources

This section describes the affected environment and potential effects from the construction and operation of the Project as they relate to visual resources. The description of the affected environment and assessment of potential impacts were developed by reviewing existing data sources (e.g., New York, Massachusetts, and Rhode Island State GIS repositories, previously completed visual impact assessments for the Revolution Wind Farm, the South Fork Wind Farm, the Block Island Wind Farm, and the USACE Visual Resource Assessment Procedure [VRAP]), environmental studies, published scientific literature relating to the evaluation of visual impacts to visually sensitive resources (VSRs), and correspondence and consultation with federal and state agencies (see Appendix A).

Additionally, Sunrise Wind completed the *Sunrise Wind Offshore Wind Farm Visual Impact Assessment Study Plan – Offshore* and the *Sunrise Wind Offshore Wind Farm Visual Resources Assessment Study Plan –Onshore Substation* and submitted them to BOEM, state agencies in New York, Massachusetts, and Rhode Island, and tribal representatives in 2019 and early 2020 for review. Specific requirements for submittal of impact to visual resources information within this COP are provided in these documents as well as BOEM's *Guidelines for the Protection of Environmental and Historic Resources pursuant to 30 CFR Part 585 Subpart F*. In addition, the SRWEC–NYS and Onshore Facilities are subject to review under the New York State Public Service Law (Article VII) and NYSDEC's Program Policy, *Assessing and Mitigating Visual and Aesthetic Impacts*. These sources provide regulations and guidance associated with the siting of major electric transmission facilities and the associated visual assessment procedures.

A description of the existing visual environment and the visual resources within the Visual Study Area for the SRWF (SRWF VSA) and the Onshore Facilities are provided below, followed by an evaluation of potential Project-related visual impacts. Visual effects to scenic resources associated with the construction of the SRWEC are not anticipated due to the temporary nature of this activity and the anticipated use of construction vessels in an offshore setting, where vessel traffic is commonplace. During O&M, the SRWEC will be buried beneath the seafloor and, therefore, will not result in impacts to visual resources. More detailed information concerning visual resources associated specifically with the SRWF and OnCS–DC is presented in Appendix Q1 and Appendix Q2, respectively.

4.5.1.1 Affected Environment

SRWF

Visual Study Area and Zone of Visual Influence

BOEM's *Information Guidelines for a Renewable Energy Construction and Operations Plan (COP)* (BOEM 2020) indicates that visual impacts should be evaluated using photo simulations from locations within "the onshore viewshed from which renewable energy structures, whether located offshore or onshore, would be visible." While a standard visual study area for offshore wind farms has not been expressly defined in regulatory guidance documents, this statement suggests that the SRWF VSA should include all areas with any level of potential visibility of the SRWF.

CONSTRUCTION AND OPERATIONS PLAN

Site Characterization and Assessment of Impacts – Visual Resources

The first step in defining the maximum extent of WTG visibility in an offshore setting is to determine the likely physical threshold for potential visibility based on the screening effect of the curvature of the Earth. A previous analysis completed by EDR on the operational Block Island Wind Farm suggests that WTGs will generally become completely screened at a distance between 35 mi (56.3 km) and 40 mi (64.4 km), depending on the elevation of the viewer and height of the WTG (EDR 2017). This inference is supported by a study titled *Offshore Wind Turbine Visibility and Visual Impact Threshold Distances*, which concluded that offshore wind facilities were judged to be a major focus of visual attention at distances up to 10 mi (16 km); were noticeable to casual observers at distances of almost 18 mi (29 km); and were visible with extended or concentrated viewing at distances beyond 25 mi (40 km) (Sullivan et al. 2012). A more recent study undertaken by the NYSERDA suggests that offshore wind energy projects of typical magnitude (considered to be 100 8-MW WTGs) would have minimal visual effects at a distance of 20 mi (32.2 km) and negligible effect beyond 25 mi (40.2 km) (EDR 2017).

Observations of the constructed Block Island Wind Farm and verified line of sight models suggest that daytime visibility will diminish completely at approximately 28.2 mi (45.4 km) at beach level and 36 mi (57.9 km) from an elevated vantage point (153 ft AMSL).

The threshold distances for visibility assume ideal viewing conditions; atmospheric haze, cloud cover, and human visual acuity are all significant influential factors in actual project visibility.

Based on the information presented above, the SRWF VSA was conservatively defined as the area within a 40-mi (64.4 km) radius of the SRWF (Figure 4.5.1-1). The SRWF VSA includes approximately 6,854 mi² (17,751 km²) of open ocean, 685 mi² (1,774 km²) of land (including inland water bodies) and approximately 615 linear mi (990 linear km) of shoreline in New York, Connecticut, Massachusetts, and Rhode Island. The VSA includes all or portions of 2 towns in New York, 2 towns in Connecticut, 16 towns in Massachusetts, and 17 towns in Rhode Island (Table 4.5.1-1). Distance from shore to SRWF WTGs, at their closest point, is approximately 30.5 mi (49 km) from Long Island, 16.7 mi (27 km) from Block Island, 25.5 mi (41 km) from mainland Rhode Island, 31.8 mi (51 km) from mainland Massachusetts, 18.8 mi (30 km) from Martha's Vineyard, and 34.4 mi (55 km) from Nantucket.

\\edpcc.com\jobs\19195_Sunrise Wind\Graphics\Figures\COP\MXD\19195_COP_Figure 4.5.1-1_Sunrise Wind Farm Visual Study Area.mxd Revised: 2020-12-09 By: jloughlin

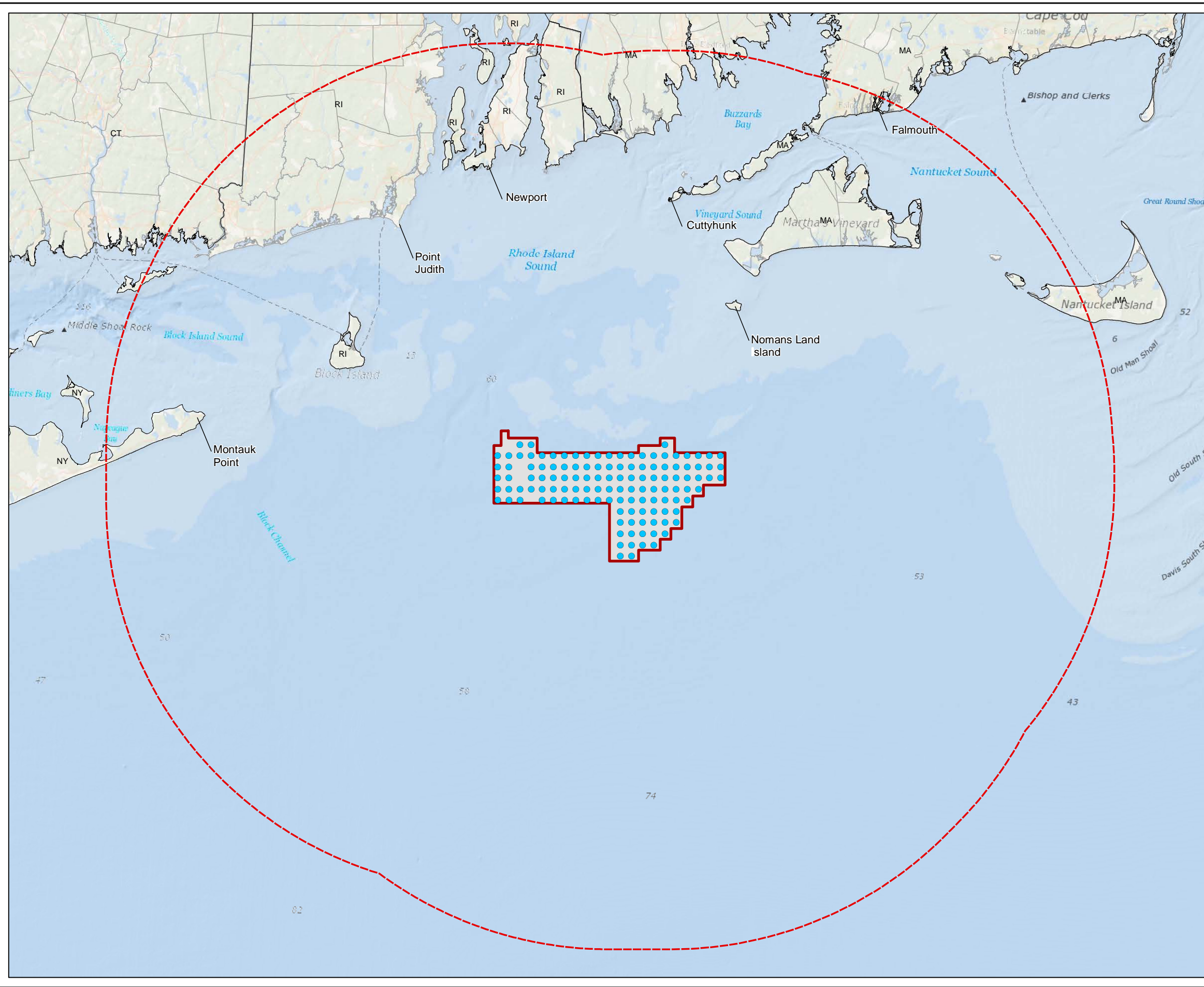

**Figure 4.5.1-1
Sunrise Wind Farm
Visual Study Area**

Sunrise Wind | Powered by Ørsted & Eversource

Legend

- Indicative Turbine Layout (WTG)
- Project Envelope
- Sunrise Wind Farm Visual Study Area (40 miles from Project Envelope)

Sources

Notes: 1. Basemap: ESRI ArcGIS Online "World Ocean Base" map service. 2. This map was generated in ArcMap on December 9, 2020. 3. This is a color graphic. Reproduction in grayscale may misrepresent the data.

Date	09/01/2020
Project Number	2028113199
Prepared By	RCN
Reviewed By	GWP

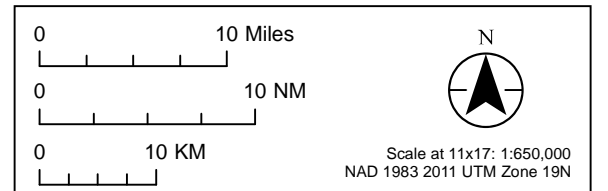

REFERENCE MAP

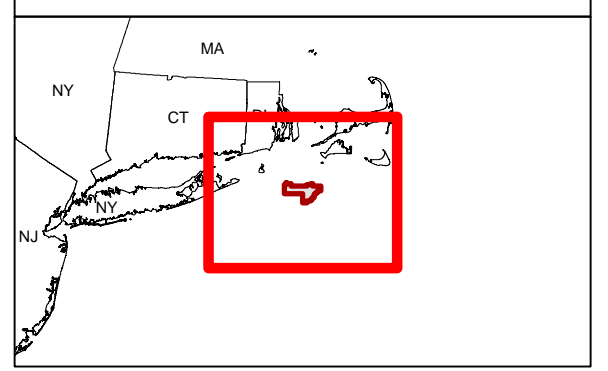

This page intentionally left blank

CONSTRUCTION AND OPERATIONS PLAN

Site Characterization and Assessment of Impacts – Visual Resources

Table 4.5.1-1 States, Counties, and Towns Within the SRWF Visual Study Area

State	County	Town
New York	Suffolk	East Hampton, Southold
Connecticut	New London	North Stonington, Stonington
Massachusetts	Barnstable	Falmouth, Mashpee
	Bristol	Dartmouth, Fairhaven, Fall River, New Bedford, Westport
	Dukes	Aquinnah, Chilmark, Edgartown, Gosnold, Oak Bluffs, Tisbury, West Tisbury
	Nantucket	Nantucket
	Plymouth	Mattapoissett
Rhode Island	Kent	East Greenwich, West Greenwich
	Newport	Jamestown, Little Compton, Middletown, Newport, Portsmouth, Tiverton
	Washington	Charlestown, Exeter, Hopkinton, Narragansett, New Shoreham, North Kingstown, Richmond, South Kingstown, Westerly

Within the VSA, only a relatively small portion of the landward VSA would have open views that would include the SRWF. To determine the extent of this area, a lidar¹⁹ viewshed analysis was completed to define all geographic areas of visibility within the VSA. The viewshed model considered screening by vegetation, buildings/structures, and the curvature of the Earth to delineate those areas that may have potential views of the highest portions of the WTGs (i.e., blade tips in the upright position) based on the Project Design Envelope maximum WTG height of 968 ft (295 m) AMSL, which represent the tallest structures of the SRWF. The viewshed analysis results indicated that 34 mi² (88 km²), or 5 percent of the landward VSA, could have potential views of the SRWF from ground-level vantage points. These areas of potential visibility generally occur within the coastal mainland and islands associated with New York, a small portion of Connecticut, Massachusetts, and Rhode Island. Contiguous areas of visibility occur on the beaches oriented toward the SRWF and smaller, less well-defined areas of visibility tend to occur in elevated inland areas associated with Block Island, south mainland Rhode Island, portions of Montauk, NY, and the elevated portions of Martha's Vineyard. These areas of potential visibility of the SRWF are henceforth known as the zone of visual influence (ZVI) and are illustrated in Figure 4.5.1-2. For the purposes of determining potential impacts to visual resources resulting from the SRWF, the ZVI represents areas in which further analysis was warranted to determine the degree of visibility and visual impact. A comprehensive description of the viewshed analysis used to define the ZVI is included in Appendix Q1.

¹⁹ Lidar, a remote sensing method that measures variable distances to Earth, uses light in the form of pulsed lasers combined with other data to generate precise, three-dimensional information about the Earth and surface characteristics.(NOAA 2019).

This page intentionally left blank

\\edp.c.com\jobs\19195_Sunrise Wind\Graphics\Figures\COP\MXD\19195_COP_Figure 4.5.1-2_Sunrise Wind Farm Zone of Visual Influence.mxd Revised: 2020-12-09 By: Joughlin

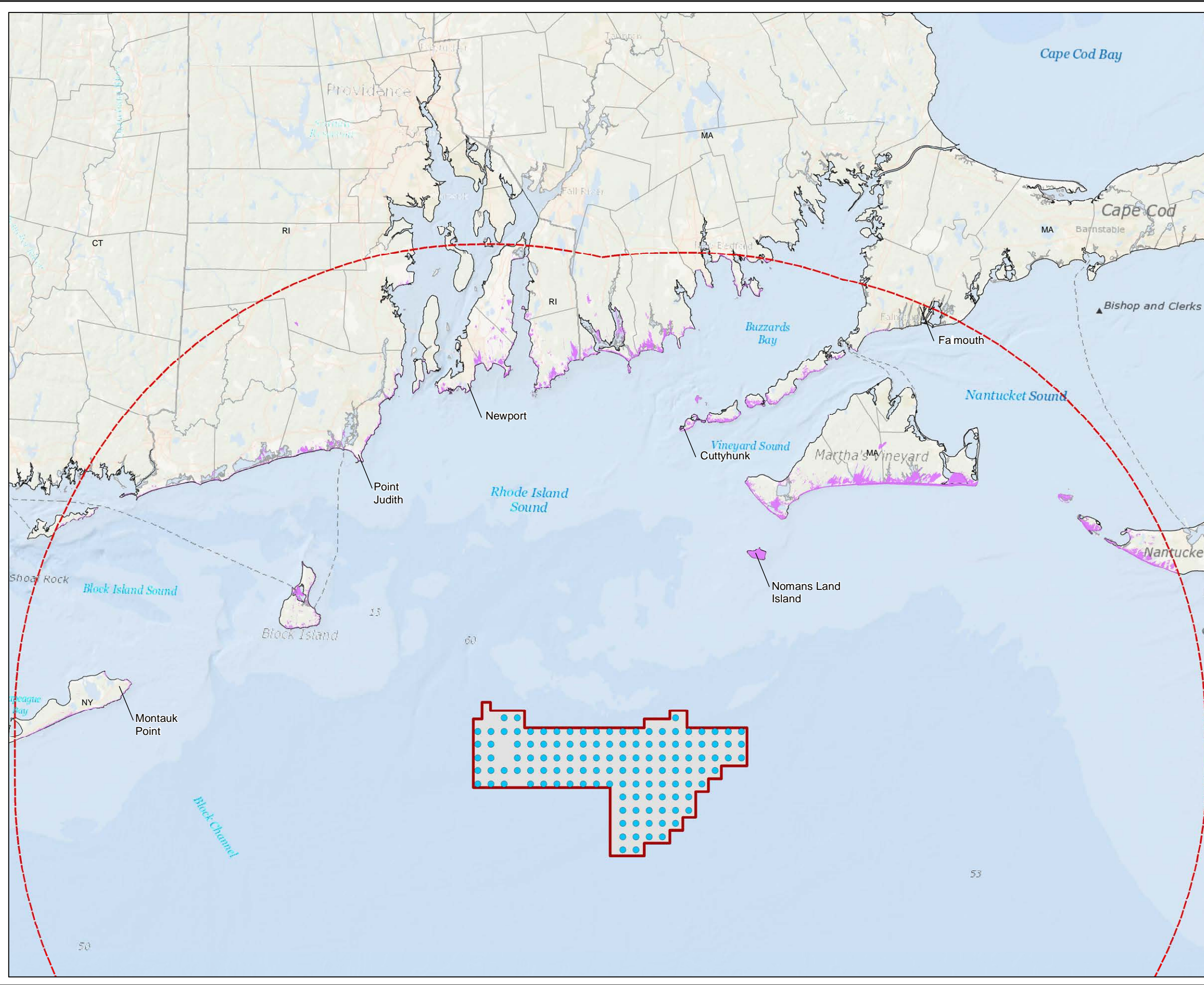

**Figure 4.5.1-2
Sunrise Wind Farm
Zone of Visual Influence**

Sunrise Wind | Powered by Ørsted & Eversource

- Legend**
- Indicative Turbine Layout (WTG)
 - Sunrise Wind Farm Zone of Visual Influence (SRWF ZVI)
 - Project Envelope
 - Sunrise Wind Farm Visual Study Area (SRWF VSA)

Sources
Notes: 1. Basemap: ESRI ArcGIS Online "World Ocean Base" map service. 2. This map was generated in ArcMap on December 9, 2020. 3. This is a color graphic. Reproduction in grayscale may misrepresent the data.

Date	09/01/2020
Project Number	2028113199
Prepared By	RCN
Reviewed By	GWP

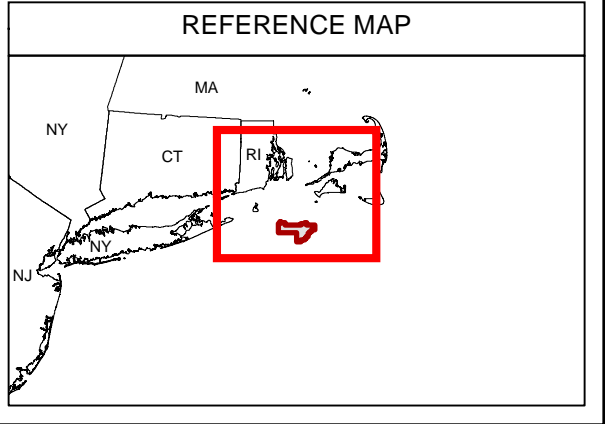
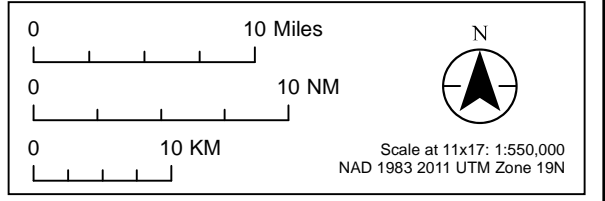

This page intentionally left blank

CONSTRUCTION AND OPERATIONS PLAN

Site Characterization and Assessment of Impacts – Visual Resources

Visual Study Area Description

Islands

Islands cumulatively total approximately 204.6 mi² (530 km²) of land within the VSA, and 22.2 mi² (57 km²) occur within the SRWF ZVI. These islands include Long Island, Block Island, Conanicut Island, Prudence Island, Aquidneck Island, the Elizabeth Islands, Martha's Vineyard, Nantucket, and several smaller islands scattered along the coasts of Connecticut, Massachusetts, and Rhode Island. Topography on the islands is typically undulating to gently rolling, with dunes and/or steep bluffs occurring along the island shorelines. Island elevations range from sea level to a maximum of approximately 307 ft (94 m) AMSL, which occurs along Pasture Road in Chilmark on Martha's Vineyard. Cuttyhunk Island, Block Island, and Long Island also have prominent highpoints ranging from 130 to 200 ft (40 to 61 m) AMSL. Vegetation on the islands is typically characterized by a mix of scrub forest, grassy dunes, salt marshes, freshwater wetlands, and open fields (agricultural and successional). Developed areas include seasonal and year-round homes, villages, roads, and ports.

Mainland

The SRWF VSA includes approximately 480.2 mi² (1244 km²) of mainland: 33.2 mi² (86 km²) in Connecticut, 340.5 mi² (882 km²) in Rhode Island, and 106.5 mi² (276 km²) in Massachusetts (mainland New York does not occur within the VSA). The ZVI includes approximately 10.4 mi² (27 km²) of total mainland area composed of <0.1 mi² (<1 km²) in Connecticut, 4.9 mi² (13 km²) in Massachusetts, and 5.5 mi² (14 km²) in Rhode Island.

Within the mainland portion of the VSA, elevations range from sea level along the coast to a high point of 528.2 ft (161 m) AMSL in Exeter, Rhode Island. The mainland coast has variable topography. Barrier beaches and dunes are typically backed by salt ponds and tidal marshes along much of the mainland coast in Massachusetts and Rhode Island. However, in areas such as Watch Hill and Point Judith, RI, the shoreline topography is defined by steep bluffs and cliffs, along with fewer coastal ponds and marshes. Between Watch Hill and Point Judith, a series of salt ponds extend landward behind coastal spits. Inland from the coast, mainland topography rises gradually but remains fairly level to gently rolling. Low hills and valleys are primarily forested with scattered freshwater lakes, ponds, and occasional agricultural land. A low ridge formed by a glacial moraine is oriented roughly parallel to the coast, varying between approximately 1 and 1.5 mi (1.5 and 2.4 km) inland of shoreline. Soils are generally thin and rocky as evidenced by abundant surface rock and stone walls. Residential development occurs throughout the area, with the highest density found in villages and towns along the coast. Outside the village/town center areas, inland development is more scattered and low-density within a largely forested landscape.

CONSTRUCTION AND OPERATIONS PLAN

Site Characterization and Assessment of Impacts – Visual Resources

Atlantic Ocean

The portions of the Atlantic Ocean that occur within the SRWF VSA include Rhode Island Sound, Block Island Sound, Narragansett Bay, Fischer's Island Sound, Buzzards Bay, Mount Hope Bay, Vineyard Sound, Nantucket Sound, and other bays and coves. Due to the abundance of open views across the expanse of ocean, sounds, and bays, approximately 96 percent of the water areas also occur within the ZVI. This area is characterized by broad expanses of open water, with depths up to approximately 367 ft (112 m). Depending on weather conditions, the texture of the ocean surface ranges from smooth to choppy, and its color ranges from blue, to silver, to dark gray. The ocean in this area is a working water landscape that supports significant human activity including recreational and commercial fishing, commercial shipping, ferry transportation, pleasure boating and sailing, and associated maritime activities and features (e.g., buoys, channel markers, warning lights).

Distance Zones

In addition to the ZVI, distance zones were established based on methodologies such as Landscape Aesthetics (USDA, US Forest Service 1995) and the Bureau of Land Management (BLM) Visual Resource Inventory (BLM 2009). Consistent with established agency guidance, distance zones for this VIA are defined as follows:

- Foreground-Middle Ground: 0 to 5 mi (0 to 8.0 km)
- Background: 5 to 15 mi (8.0 to 15 km)
- Extended Background: Over 15 mi (24.1 km)

Due to the distance at which the SRWF will be most frequently viewed, the curvature of the Earth and atmospheric conditions will have a substantial influence on Project visibility. Studies that have been completed in Europe and the US on existing offshore wind installations suggest that within the Extended Background zone, visibility zones can be further delineated until the point of complete diminishment. As demonstrated in Figure 4.5.1-3, WTGs that are positioned in the zone between 15 and 20 mi (24 and 32 km) are typically described as being visible but less noticeable to the casual observer. At this distance, the WTGs are likely subordinate to other elements in the landscape that will draw a viewer's attention such as vessels on the water, waves on the shoreline, etc. Between 20 and 25 mi (32 and 40 km), WTGs are typically visible only after extended or concentrated viewing (Sullivan 2012). Beyond 25 mi (40 km), the WTGs are difficult to see with the unaided eye and generally require the viewer to know where to look to see the WTGs. It should be noted that the current turbine technology being considered for the SRWF is much larger than any currently constructed wind farm in Europe, and, therefore, may result in greater visibility at the distances noted. However, it is anticipated that complete diminishment of potential visibility occurs beyond 35 mi (56 km) due to a combination of human acuity, screening from the curvature of the Earth (only the turbine blades appear above the horizon), and atmospheric diminishment (See Appendix Q1, Section 3.1.3).

CONSTRUCTION AND OPERATIONS PLAN

Site Characterization and Assessment of Impacts – Visual Resources

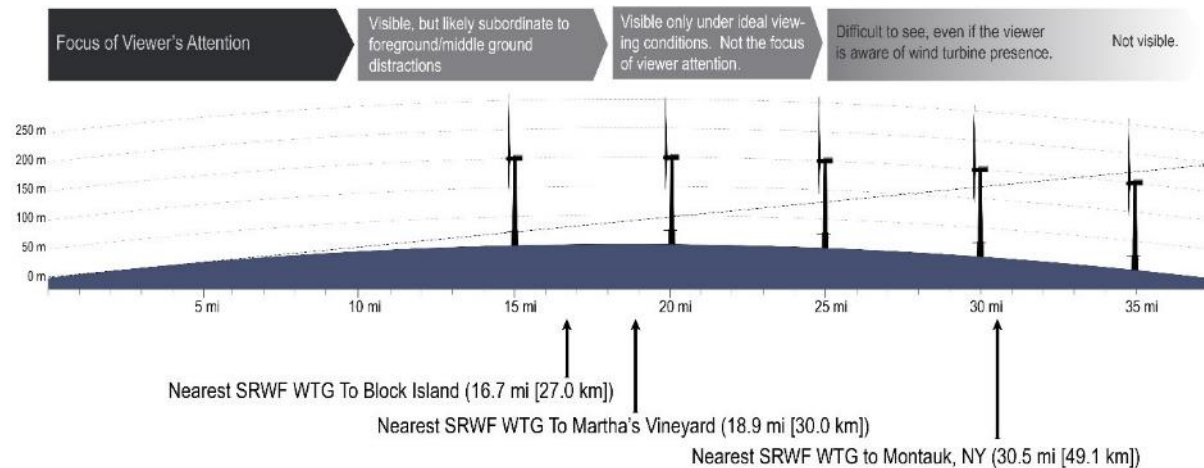

Figure 4.5.1-3 Turbine Visibility

Landscape Similarity Zones and Management Classification System

The definition of landscape or seascape types found in the ZVI provides a useful framework for the analysis of existing visual resources and viewer circumstances. These landscape types, referred to as Landscape Similarity Zones (LSZs), are defined based on the similarity of landscape features such as landform, vegetation, water, and land use patterns. Within the ZVI, 17 separate LSZs were defined: Open Water, Shoreline Beach, Coastal Bluff, Developed Waterfront, Coastal Dunes, Shoreline Residential, Salt Pond/Tidal Marsh, Coastal Scrub, Maintained Recreation Area, Forest, Rural Residential, Suburban Residential, Village, Commercial, Agricultural/Open Field, Inland Lakes and Ponds, and Highway Transportation.

To establish a baseline scenic quality threshold for the ZVI, the VRAP management classification system (MCS) was used. The MCS portion of this methodology establishes an assessment framework by evaluating the visual quality/sensitivity to visual impact of each of the defined LSZs. Using a scoring system and forms based on those provided in the VRAP Manual (Smardon et al. 1988), this evaluation assigns each LSZ a specific MCS designation (Preservation, Retention, Partial Retention, Modification, or Rehabilitation), each of which has a numerical threshold of acceptable visual change. According to the VRAP Manual (Smardon et al. 1988), projects in zones with each classification should have the following visual impact assessment values:

- Preservation Class – 0
- Retention Class – No lower than minus 2
- Partial Retention Class – No lower than minus 5
- Modification Class – No lower than minus 6
- Rehabilitation Class – Greater than 0 (i.e., project should only improve visual quality)

The VIA scores and the completed evaluation forms were also reviewed to discern the basis for the documented visual impact, and to determine the type and level of visual mitigation, if any, that would be appropriate within the affected LSZs.

CONSTRUCTION AND OPERATIONS PLAN

Site Characterization and Assessment of Impacts – Visual Resources

Since the MCS procedure is more applicable to changes within the individual LSZs, the VRAP methodology was adapted based on consultation with BOEM and several other visual professionals to account for changes to individual key observation points (KOPs). To accomplish this, the MCS ratings will also be compared to the assessment of the existing view considered for each KOP to insure consistency and/or variable factors within each LSZ. If a single view exceeds the MCS classification, the classification for that view is increased based on the existing view score. Similarly, if the existing view rates lower than the MCS, the factors leading to this variability will be discussed, and the SRWF will be rated in the context of the existing view and the MCS score. A project's visual impact is compared to these thresholds in the VIA portion of the VRAP (see discussion in Section 4.5.1.2).

User Groups

Viewers within the ZVI include residents, through-travelers, tourists/vacationers, and the fishing community. The sensitivity of these viewers to visual change is variable, but many are assumed to be sensitive to changes in views they value and/or are familiar with.

Visually Sensitive Resources

The identification of VSRs is an important step in determining locations which may be particularly sensitive to visual change. These resources have generally been identified by national, state, or local governments, organizations, and/or Native American tribes as important sites which are afforded a level of recognition or protection. Avoiding or minimizing impacts to these resources is an important consideration in the planning stages of a project. For the VIA (Appendix Q1), a comprehensive inventory of VSRs was prepared for the entire SRWF VSA and then a GIS analysis was conducted to determine how many of these resources occur within the Project ZVI and would require further evaluation. Based on the results of this analysis, a total of 487 VSRs occur within the ZVI. A comprehensive list of resources that occur within the VSA and ZVI is included in Appendix Q1.

Selection of Key Observation Points

Based on the photo documentation conducted during field verification and a review of data regarding viewer activity and sensitive public resources, a total of 40 unique KOP locations was selected for the development of the visual simulations. Daytime simulations were prepared for all 40 of the KOP locations. To demonstrate the appearance of the aviation and navigation warning lights, nighttime simulations were prepared for four of the KOPs. Additionally, alternative conditions simulations were prepared for six KOP, and four KOPs were selected for the development of video time lapse simulations illustrating an approximately 18-hour period including nighttime, and variable daytime weather conditions. Six additional KOPs were selected to produce visual simulations, but subsequent alignment of the views determined that the SRWF would be substantially or completely screened from view. The KOPs lacking visibility of the SRWF are listed in Table 4.5.1-2.

CONSTRUCTION AND OPERATIONS PLAN

Site Characterization and Assessment of Impacts – Visual Resources

Table 4.5.1-2 KOPs With Minimal or No Visibility of the SRWF

MV01	Squibnocket Farm	Town of Chilmark, Dukes County, Massachusetts	41.31858° N, 70.76507° W
MV04	Gay Head Community Baptist Church	Town of Aquinnah, Dukes County, Massachusetts	41.3411° N, 70.8135° W
B101	Island Cemetery	Town of New Shoreham, Washington County, Rhode Island	41.17895° N, 71.58074° W
B113	North Light	Town of New Shoreham, Washington County, Rhode Island	41.2275° N, 71.5758° W
NI09	Eel Point	Town of Nantucket, Nantucket County, Massachusetts	41.2938° N, 70.1799° W
C02	Fort Wetherill State Park	Town of Jamestown, Newport County, Rhode Island	41.4778° N, 71.3595° W

The 40 KOPs selected for visual simulations considered the following criteria:

- They were identified as KOPs by federal, state, local, or tribal officials/agencies as important visual resources, either in prior studies or through direct consultation.
- They provide clear, unobstructed views toward the SRWF site (as determined through field verification).
- They illustrate the most open views available from historic sites, designated scenic areas, and other visually sensitive resources within the ZVI.
- They are representative of a larger group of candidate KOPs of the same type or in the same geographic area.
- They illustrate typical views from LSZs where views of the Project are most likely to be available.
- They illustrate typical views of the proposed Project that will be available to representative viewer/user groups within the ZVI.
- They illustrate typical views from a variety of geographic locations and under different lighting conditions to illustrate the range of visual change that could occur with the Project in place.

Locations of the selected KOPs are shown in Figure 4.5.1-4. Information regarding each selected viewpoint is summarized in Table 4.5.1-3.

CONSTRUCTION AND OPERATIONS PLAN

Site Characterization and Assessment of Impacts – Visual Resources

Table 4.5.1-3 KOPs Selected for Visual Simulations of the SRWF

KOP	Viewpoint Name	Location	Latitude, Longitude (WGS 84)
New York			
LI01	Camp Hero State Park Overlook	Town of East Hampton, Suffolk County	41.0572° N, 71.8717° W
LI04	Montauk Point State Park	Town of East Hampton, Suffolk County	41.0721° N, 71.8590° W
Massachusetts			
CI01	Cuttyhunk Island	Town of Gosnold, Dukes County	41.4205° N, 70.9341° W
MM01	Gooseberry Island	Town of Westport, Bristol County	41.4851° N, 71.0388° W
MM04	Nobska Lighthouse	Town of Falmouth, Barnstable County	41.5158° N, 70.6551° W
MM06	Demarest Lloyd State Park	Town of Dartmouth, Bristol County	41.5261° N, 70.9807° W
MM07	Fort Taber District	Town of New Bedford, Bristol County	41.5950° N, 70.9023° W
MV02	Philbin Beach	Town of Aquinnah, Dukes County	41.3374° N, 70.8289° W
MV03	Lucy Vincent Beach	Town of Chilmark, Dukes County	41.3395° N, 70.7257° W
MV05	Moshup Beach	Town of Aquinnah, Dukes County	41.3413° N, 70.8323° W
MV07	Aquinnah Overlook	Town of Aquinnah, Dukes County	41.3473° N, 70.8370° W
MV09	Gay Head Lighthouse	Town of Aquinnah, Dukes County	41.3483° N, 70.8345° W
MV10	South Beach State Park	Town of Edgartown, Dukes County	41.3498° N, 70.5310° W
MV11	Wasque Point	Town of Edgartown, Dukes County	41.3508° N, 70.4618° W
MV12	Peaked Hill	Town of Chilmark, Dukes County	41.3552° N, 70.7353° W
MV13	Edwin D Vanderhoop	Town of Aquinnah, Dukes County	41.3460° N, 70.8355° W
NI10	Madaket Beach	Town of Nantucket, Nantucket County	41.2702° N, 70.2013° W
NL01	Nomans Land Island	Town of Chilmark, Dukes County	41.2571° N, 70.8308° W
Rhode Island			
AI01	Brenton Point State Park	Town of Newport, Newport County	41.4504° N, 71.3548° W
AI03	Newport Cliff Walk	Town of Newport, Newport County	41.4512° N, 71.3116° W
AI05	Sachuest Point National Wildlife Refuge	Town of Middletown, Newport County	41.4727° N, 71.2472° W
AI06	Sachuest Beach (Second)	Town of Middletown, Newport County	41.4880° N, 71.2580° W
AI07	Hanging Rock	Town of Middletown, Newport County	41.4913° N, 71.2590° W
AI09	Easton's Beach	Town of Newport, Newport County	41.4883° N, 71.2914° W
BI02	Great Salt Pond	Town of New Shoreham, Washington County	41.1949° N, 71.5886° W
BI04	Southeast Lighthouse	Town of New Shoreham, Washington County	41.1528° N, 71.5519° W
BI06	New Shoreham Beach	Town of New Shoreham, Washington County	41.1485° N, 71.5753° W
BI08	Fred Benson Beach	Town of New Shoreham, Washington County	41.18850° N, 71.56679° W
BI16	Mohegan Bluffs	Town of New Shoreham, Washington County	41.15121° N, 71.55863° W
BI12	Clayhead Trail	Town of New Shoreham, Washington County	41.2127° N, 71.5551° W

CONSTRUCTION AND OPERATIONS PLAN

Site Characterization and Assessment of Impacts – Visual Resources

KOP	Viewpoint Name	Location	Latitude, Longitude (WGS 84)
C01	Beavertail Lighthouse	Town of Jamestown, Newport County	41.4498° N, 71.3985° W
RI01	Watch Hill Lighthouse	Town of Westerly, Washington County	41.3052° N, 71.8578° W
RI02	Weekapaug Breachway	Town of Westerly, Washington County	41.3289° N, 71.7631° W
RI03	Point Judith Lighthouse	Town of Narragansett, Washington County	41.3631° N, 71.4810° W
RI04	South Shore Beach	Town of Little Compton, Newport County, Rhode Island	41.49548° N, 71.3312° W
RI06	Trustom Pond National Wildlife Refuge	Town of South Kingstown, Washington County	41.3722° N, 71.5869° W
RI08	Scarborough Beach	Town of Narragansett, Washington County	41.3909° N, 71.4713° W
RI09	Narragansett Beach	Town of Narragansett, Washington County	41.4386° N, 71.4498° W
RI11	Matunuck Beach	Town of South Kingstown, Washington County, Rhode Island	41.37446° N, 71.54615° W
RI12	Ninigret National Wildlife Refuge	Town of Charlestown, Washington County	41.3604° N, 71.6544° W

This page intentionally left blank

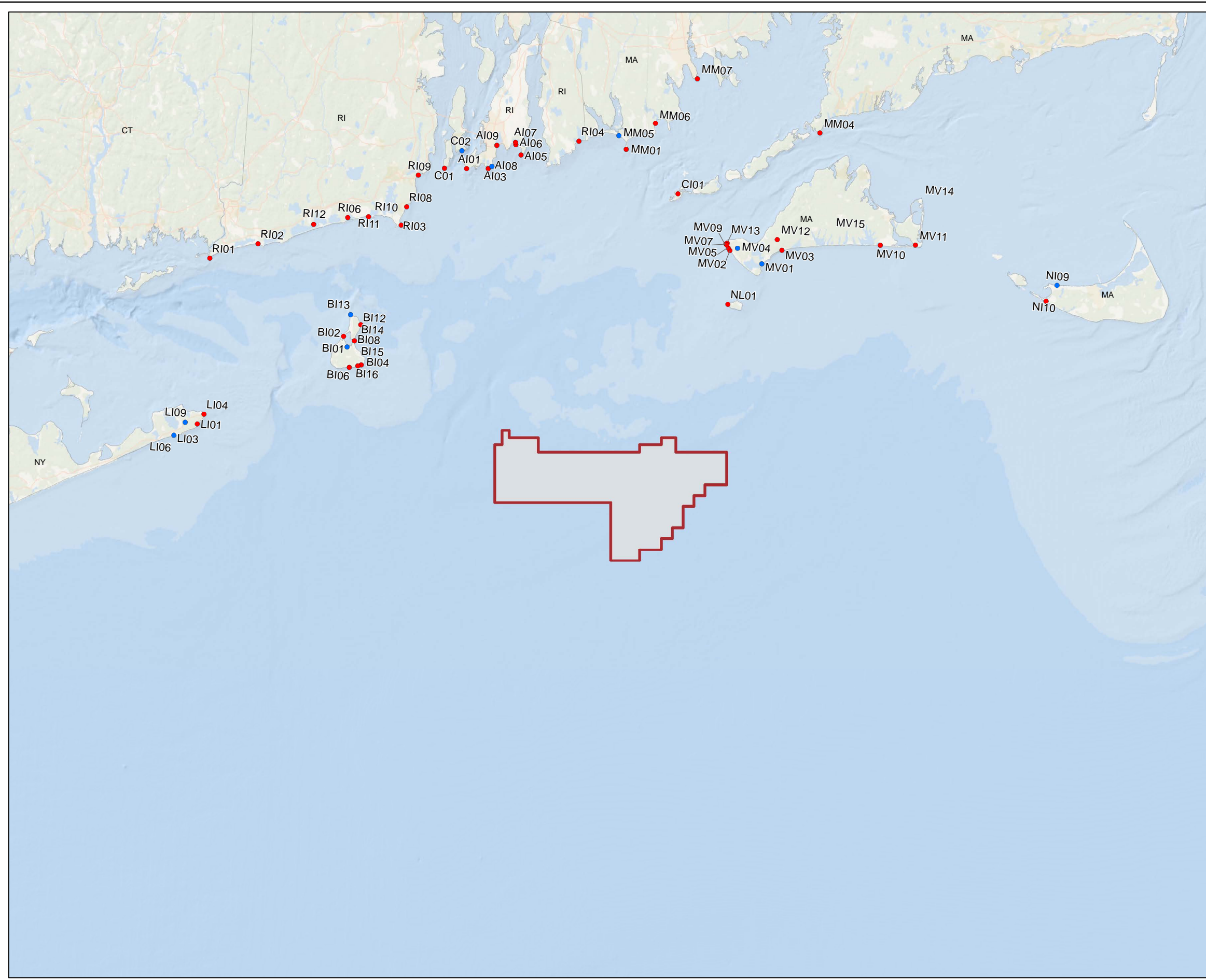

**Figure 4.5.1-4
Key Observation Point Locations
SRWF VSA**

Sunrise Wind | Powered by Ørsted & Eversource

Legend

- Key Observation Point (KOP)
- Selected Key Observation Point (KOP)
- Project Envelope

Sources
Notes: 1. Basemap: ESRI ArcGIS Online "World Ocean Base" map service. 2. This map was generated in ArcMap on June 7, 2021. 3. This is a color graphic. Reproduction in grayscale may misrepresent the data.

Date	09/01/2020
Project Number	2028113199
Prepared By	RCN
Reviewed By	GWP

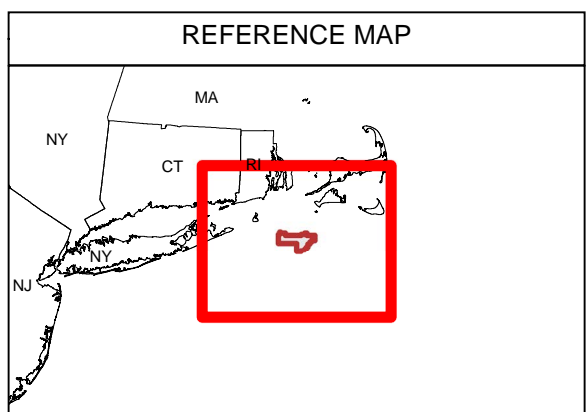
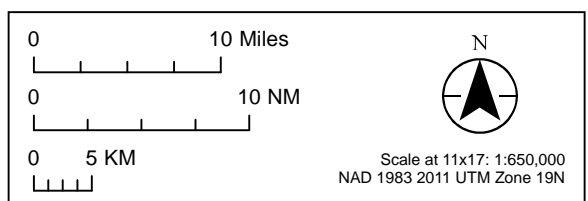

This page intentionally left blank

CONSTRUCTION AND OPERATIONS PLAN

Site Characterization and Assessment of Impacts – Visual Resources

SRWEC–OCS

Construction of the SRWEC–OCS will occur approximately 3.5 mi (6 km) from shore and will be temporary and mobile in nature. It is not anticipated that the construction of the SRWEC–OCS will result in visual impacts to onshore resources. Additionally, during O&M, the SRWEC will be buried beneath the seafloor and, therefore, will not result in impacts to visual resources. As such, the existing visual environment is not defined for these components.

SRWEC–NYS

The SRWEC–NYS construction activities are anticipated to occur within the viewshed of Fire Island. This area includes the Fire Island National Seashore, a popular tourism destination that hosts a variety of activities such as sightseeing, hiking, biking, and various beach activities. While the viewshed associated with the construction activity cannot be easily defined due to the mobile nature of installation vessels, it is anticipated that potential temporary visual impacts could occur when these activities occur within 0.5 mi (2,640 ft/0.8 km) of the Fire Island shoreline. During O&M, the SRWEC will be buried beneath the seafloor and, therefore, will not result in impacts to visual resources.

Onshore Facilities

Visual Study Area and Zone of Visual Influence

The OnCS–DC will be the only major visible components of the Onshore Facilities during the operational phase of the Project and, therefore, the only components that have the potential to result in impacts to visual resources. Temporary impacts during construction associated with the Onshore Transmission Cable route is also considered for specific resources occurring within the construction corridor.

The OnCS–DC is located in the Town of Brookhaven, NY on a developed site currently occupied by various commercial industries/small businesses. The Union Avenue Site is generally located east of a liquified natural gas facility and south of the LIE. The OnCS–DC VSA extends 3 mi (4.8 km) around the proposed limit of disturbance associated with the OnCS–DC site. It is anticipated the tallest components of the OnCS–DC will be the lightning masts, which will have a maximum height of 100 ft (30 m). Since the lightning masts have a relatively slender profile, it is anticipated that this portion of the OnCS–DC will not be visible beyond approximately 1 mi (1.5 km), but the more substantive components (also the lower profile components) of the OnCS–DC could be visible from throughout the OnCS–DC VSA.

Additionally, portions of the Onshore Transmission Cable cross aesthetic resources, which may result in temporary impacts associated with construction of the Onshore Facilities.

Additional information regarding the location and types of resources are described below. Impacts to these resources are not expected during O&M, except for potential temporary impacts during non-routine maintenance that would be similar as during construction within a specific localized area.

CONSTRUCTION AND OPERATIONS PLAN

Site Characterization and Assessment of Impacts – Visual Resources

To determine the potential visibility of the OnCS–DC within the VSA and establish a ZVI, a lidar viewshed analysis was completed that considered the tallest components of the OnCS–DC and screening provided by topography, vegetation, and structures. The results of the viewshed analysis suggest that approximately 2 percent of the OnCS–DC VSA (or 0.6 mi² [1.6 km²]) could potentially have visibility of the OnCS–DC as demonstrated in Figure 4.5.1-5.

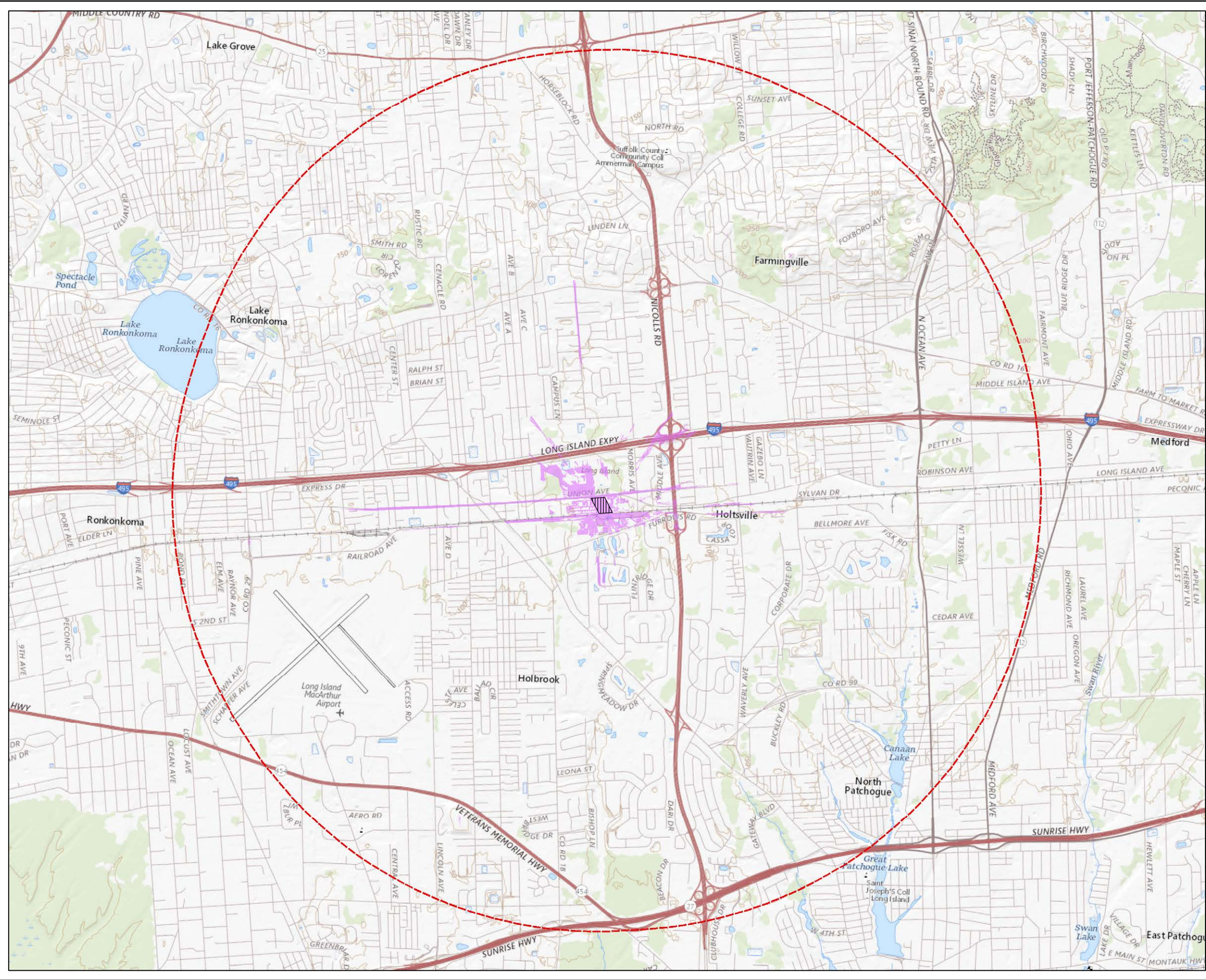

Figure 4.5.1-5
OnCS-DC Visual Study Area
and Zone of Visual Influence

Sunrise Wind | Powered by **Ørsted & Eversource**

- Legend**
- Onshore Converter Station (OnCS-DC) Zone of Visual Influence
 - Union Avenue Site
 - Onshore Converter Station (OnCS-DC) Visual Study Area

Sources
Notes: 1. Basemap: "USGS Topo Base Map" displayed via the USGS Topo Map Service. 2. This map was generated in ArcMap on April 2, 2021. 3. This is a color graphic. Reproduction in grayscale may misrepresent the data.

Date	12/18/2020 Revised 06/01/2021
Project Number	2028113199
Prepared By	RCN
Reviewed By	GWP

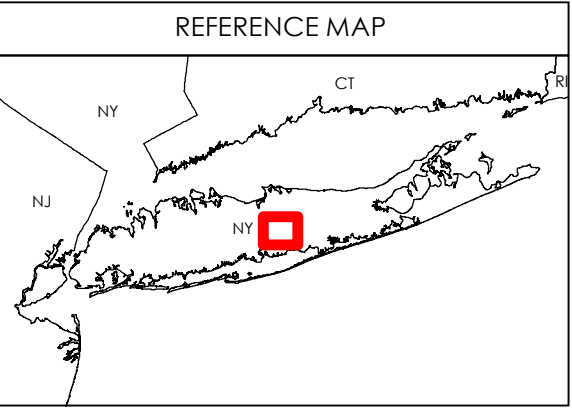
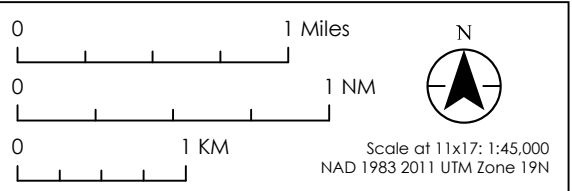

This page intentionally left blank

CONSTRUCTION AND OPERATIONS PLAN

Site Characterization and Assessment of Impacts – Visual Resources

Visual Study Area Description

The OnCS–DC VSA includes portions of the Towns of Brookhaven and Islip along with a very small portion of the Village of Lake Grove in the northwestern portion of the VSA. The entire VSA is encompassed by Suffolk County. The visual character of the VSA is generally made up of a mix of high-density development, ranging from industrial to residential. Approximately 42 percent of the VSA is comprised of single-family residences and approximately 6.3 percent is made up of high-density residential complexes such as apartment buildings. An additional 12.9 percent of the VSA is made up of industrial development such as MacArthur Airport, several substations, a LIPA generating facility/power plant, and a Liquefied Natural Gas facility located adjacent to the OnCS–DC. Recreational open space makes up approximately 12.4 percent of the VSA. These areas include parks and golf courses and planned open space and stormwater control features, which do not include facilitation for public access. The remainder of the VSA consists of schools and college campuses, agricultural land (typically nurseries), major transportation corridors (LIE and Sunrise Highway), commercial/retail areas, and local roads. Collectively, these additional land uses make up approximately 26 percent of the remaining area in the VSA.

Distance Zones

The following distance zones were delineated for the OnCS–DC VSA:

- Near-Foreground: 0 to 0.5 mi (0 to 0.8 km). At this distance, a viewer can perceive details of an object with clarity. Surface textures, small features, and the full intensity and value of color can be seen on foreground objects. The near-foreground distance zone represents 11 percent of the VSA.
- Foreground: 0.5 to 1.5 mi (0.8 to 2.4 km). At this distance, elements in the landscape tend to retain visual prominence, but detailed textures become muted. Larger scale landscape elements remain as a series of recognizable and distinguishable landscape patterns, colors, and textures.
- Middle ground: 1.5 to 3.0 mi (2.4 to 4.8 km). The middle ground is usually the predominant distance at which landscapes are seen. At these distances, a viewer can perceive individual structures and trees but not in detail. This is the zone where the parts of the landscape start to merge; individual hills become a range, individual trees merge into a forest, and buildings appear as simple geometric forms. Colors are distinguishable but subdued by a bluish cast and a softer tone than those in the foreground. Contrast in texture among landscape elements is reduced.

Landscape Similarity Zones

Defining distinct landscape types within the OnCS–DC VSA provides a useful framework for the analysis of a project's potential visual effects. LSZs within the OnCS–DC VSA were determined using GIS classification categories provided by the USGS National Land Cover Dataset (2016) and Suffolk County land use data. Individual LSZs were defined based on the similarity of various landscape characteristics, including landform, vegetation, water, and land use patterns, in accordance with established visual assessment methods (notably, Smardon et al. 1988; USDA Forest Service 1995; USDI BLM 1984; USDOT FHA 2014).

CONSTRUCTION AND OPERATIONS PLAN

Site Characterization and Assessment of Impacts – Visual Resources

Within the OnCS–DC VSA, seven distinct LSZs were identified: Residential, Industrial, Recreation & Open Space including Forest, Commercial, High-Density Residential, Institutional, and Major Transportation Corridor.

A description of these zones and their location within the OnCS–DC VSA is provided in Appendix Q2.

Visually Sensitive Resources

Using NYSDEC's recommendations for the identification of VSRs (NYSDEC 2019) and publicly available GIS data layers, 116 VSRs were identified within the OnCS–DC VSA. Of these, 17 occur within the ZVI. Based on these analyses, one historic property, one heritage area, four trails, four local parks, three NYS highways, and one school could potentially have visibility of a portion of the OnCS–DC. These visual resources and their extent of potential visibility will be discussed in further detail in Section 4.5.1.2.

The SRWEC and the Onshore Transmission Cable will be installed via HDD below portions of the Fire Island National Seashore. The Onshore Transmission Cable will be installed via HDD below the Carmans River (in the vicinity of a segment that is a NYS-designated Recreational River). These visual resources and the extent of potential visual impacts associated with construction are discussed in further detail below.

4.5.1.2 Potential Impacts

Construction and O&M activities associated with the SRWF, SRWEC–NYS, and Onshore Facilities have the potential to cause impacts to visual resources. These impacts may occur when a project compromises the scenic quality or public enjoyment of a VSR. For a visual impact to occur, the Project must first be visible. To establish the ZVI and define areas of visibility, a viewshed analysis was used. For the offshore components, a visual contrast rating system outlined in the USACE VRAP (Smardon et al. 1988) was used to determine the potential visual impacts associated with the SRWF (see Appendix Q1). For the Onshore Facilities, a viewshed analysis was completed to determine the potential visibility from visually sensitive resources within the OnCS–DC (see Appendix Q2). Since a final site selection and design had not been completed at the time of this study, visual simulations were not completed for the OnCS–DC. IPFs associated with the construction and O&M phases of the Project are identified in Figure 4.5.1-6 and described separately, by phase, for the SRWF, SRWEC–NYS, and Onshore Facilities in the following sections. Supporting information on impacts to visual resources are also presented in further detail in Appendix Q1 and Appendix Q2. Temporary construction impacts associated with the SRWEC–OCS are not addressed due to their distance from shore (greater than 3 mi (4.8 km) and the mobile nature of the construction activities.

CONSTRUCTION AND OPERATIONS PLAN

Site Characterization and Assessment of Impacts – Visual Resources

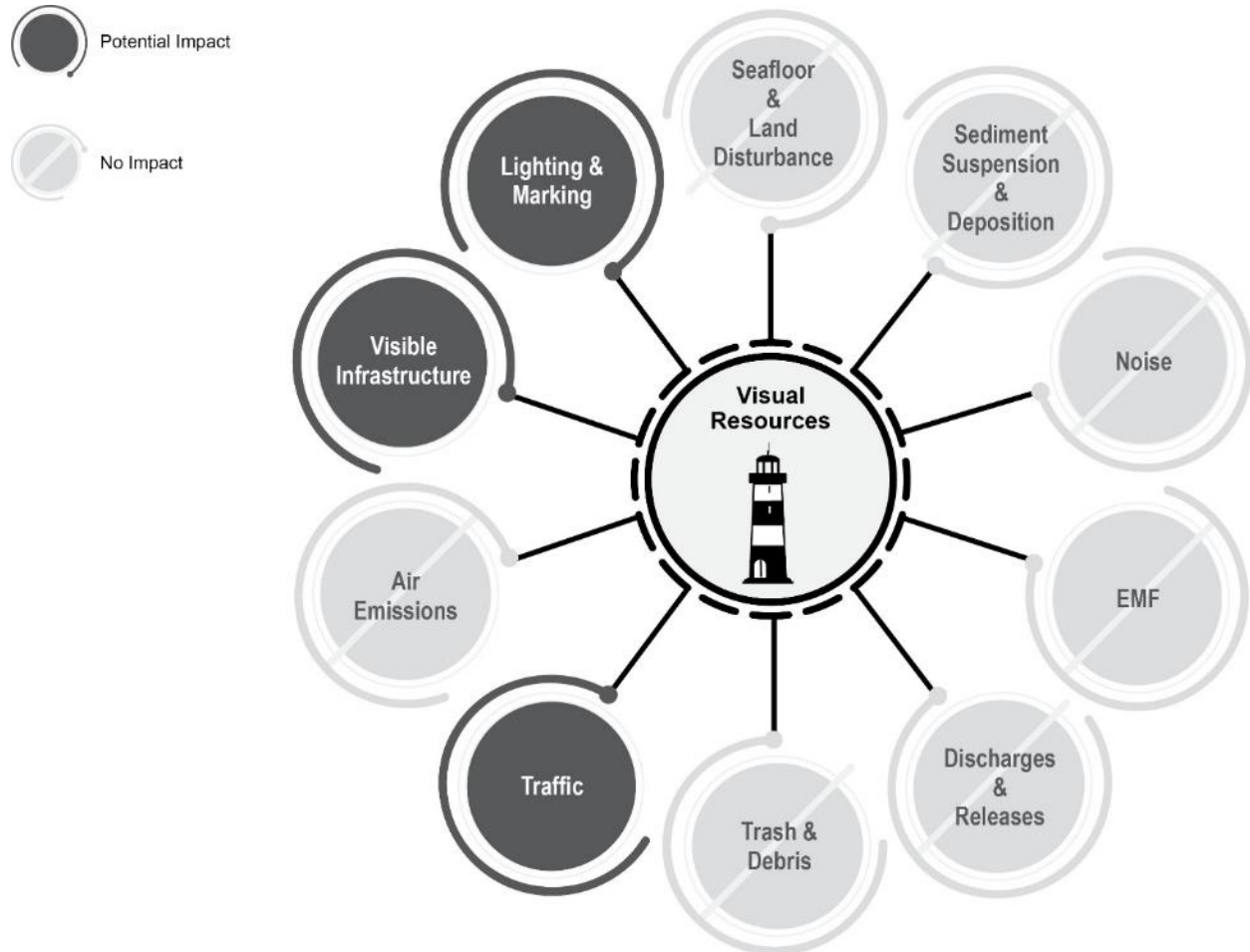

Figure 4.5.1-6 Impact-Producing Factors on Visual Resources

Sunrise Wind Farm

The IPFs associated with the SRWF that could impact visual resources include traffic, visible infrastructure, and lighting and marking. This section summarizes the potential impacts on visual resources presented in Appendix Q1, which provides additional information regarding the findings. Only those IPFs with the potential to result in negligible impacts or greater are included.

Construction

During construction, it is likely that heavy lift vessels, jack-up barges, cranes, WTGs in varying stages of assembly, and support vessels may be visible from onshore locations. While the construction phase is likely to change on a regular basis, as different portions of the SRWF are constructed, at times these features have the potential to result in temporary visual impacts. These potential visual impacts are described in more detail below.

CONSTRUCTION AND OPERATIONS PLAN

Site Characterization and Assessment of Impacts – Visual Resources

Traffic

Marine vessel traffic is common along coastal shores of the Atlantic Ocean, and it is anticipated that the vessels required for the transport, installation, and support of the Project components will not result in a significant increase in the number of vessels currently utilizing the waterways and commercial shipping lanes along the coasts of Massachusetts and Rhode Island. Many of the vessels associated with Project construction will be similar in size to existing commercial vessels, and, as such, visual impacts resulting from marine traffic will be minimal. Larger vessels used for Project construction, such as barges, may draw viewer attention in transit or stationery on the SRWF site during construction. In transit, the vessels will result in fleeting and minimal visual effect, but when stationary and visible on the horizon, they may result in short-term visual effects.

Visible Infrastructure

During construction, it is likely that vessels such as jack-up barges, cranes, and support vessels will be visible from onshore VSRs. The presence of these construction vessels along with the WTGs and OCS–DC in varying stages of construction are likely to introduce discordant visual features on the horizon. These effects will be temporary during construction and limited due to the distance from the coast; therefore, no significant visual impacts are anticipated for onshore visual resources.

Lighting and Marking

Construction activities occurring at night will likely require substantial lighting, which may result in both direct and indirect light pollution associated with the barges and vessels within the SRWF. Nighttime construction activities are likely to be visible from onshore vantage points and could result in visual impacts due to the presence of direct light sources and skyglow in a previously dark seascape. However, the visibility will be temporary in nature and at times will be obscured from view due to atmospheric conditions or the curvature of the Earth.

Operations and Maintenance

Operation of the SRWF is expected to result in visual impacts to onshore resources within the VSA. The visibility and visual impact will be variable and will depend on the existing visual quality of the resources (sensitivity to change), the distance from the SRWF, visibility of the SRWF, and geographic footprint of the SRWF. Marine traffic associated with the operation of the SRWF is expected to be less frequent than during construction of the SRWF. Given the relative frequency of seagoing vessels on the horizon within the SRWF ZVI, it is not likely that traffic related to the SRWF will be a noticeable change.

Visible Infrastructure

To evaluate potential visual impacts during operation of the SRWF, the VIA included a viewshed analysis of the potential visibility of the proposed WTGs, which represent the tallest proposed structures. Utilizing USGS lidar data, a highly detailed Digital Surface Model (DSM) of the SRWF VSA was created. The DSM included the elevations of buildings, trees, and other objects large enough to be resolved by lidar technology. Additionally, a digital terrain model (DTM) was created, representing bare earth conditions. The analysis of potential visibility of the SRWF was based on 123 points representing the proposed WTGs, each with an assumed maximum blade tip height of 968 ft (295 m) AMSL and an assumed viewer height of 6 ft (1.8 m).

CONSTRUCTION AND OPERATIONS PLAN

Site Characterization and Assessment of Impacts – Visual Resources

Distance from shore to SRWF WTGs, at their closest point, is approximately 30.5 mi (49 km) from Long Island, 16.7 mi (27 km) from Block Island, 25.5 mi (41 km) from mainland Rhode Island, 31.8 mi (51 km) from mainland Massachusetts, 18.8 mi (30 km) from Martha's Vineyard, and 34.4 mi (55 km) from Nantucket.

It should be noted that all foundation locations are considered to be WTGs in this analysis which provides flexibility in the determination of OCS–DC positions. Ultimately, the resulting ZVI conservatively considers the maximum degree of SRWF visibility within the SRWF VSA. The viewshed analysis was conducted using ESRI ArcGIS PRO® software with the Spatial Analyst extension and considered curvature of the Earth in the analysis.

Blade tip viewshed analysis results are summarized in Table 4.5.1-4. Viewshed mapping demonstrated that the WTGs have the potential to be visible from a relatively small portion of the VSA. The lidar-based viewshed analysis indicates that approximately 5 percent of the land within the Study Area (the ZVI) could have potential views of a portion of the Project WTGs based on the availability of an unobstructed line of sight. Open Water/Ocean is the dominant LSZ within the Study Area and, in most areas, offers an unobstructed line of sight toward the SRWF. Other LSZs identified by the viewshed analysis as offering potential views of the SRWF include Shoreline Beaches and Bluffs, Coastal Dunes, Coastal Scrub/Shrub Forest, Salt Ponds/Tidal Marsh, Shoreline Residential, and Maintained Recreational Areas. Visibility will be eliminated in large portions of the SRWF VSA where topography, buildings/structures, and vegetation screen views toward the WTGs. Forest, which covers approximately 54 percent of the land within the Study Area, will significantly reduce potential visibility of the SRWF throughout the inland portions of the Study Area. Considering the screening provided by buildings/structures, vegetation, and topography, potential visibility of the SRWF is largely restricted to the ocean shoreline and water bodies immediately inland of the shoreline.

Viewshed results (Table 4.5.1-4) suggest minor areas of potential SRWF visibility in inland portions of the SRWF VSA. These areas typically extend inland from undeveloped and unvegetated shorelines, especially along barrier beaches backed by salt marshes and ponds.

Additionally, some areas of inland visibility occur at topographic highpoints that are devoid of dense vegetation and buildings/structures (Appendix Q1, Figure 3.1-1).

Table 4.5.1-4 Blade Tip – Land Area Viewshed Results Summary

Distance from the SRWF	40 mi Radius Study Area (Units in Square Miles)		
	Total Land Area sq. mi.	Land Area with Potential Visibility (ZVI) sq. mi.	Percentage of VSA (%)
0 to 10 mi (0 to 16 km)	0	0	0
10 to 20 mi (16 to 32 km)	15.0 (38.8 km ²)	3.9 (10.1 km ²)	26.1
20 to 30 mi (32 to 48 km)	159.7 (413.6 km ²)	17.2 (44.5 km ²)	10.8
30 to 40 mi (48 to 64 km)	527.0 (1364.9 km ²)	13.7 (35.5 km ²)	2.6
Total 40 mi- Landward Study Area	701.7 (1817.4 km ²)	34.8 (90.1 km ²)	5.0

CONSTRUCTION AND OPERATIONS PLAN

Site Characterization and Assessment of Impacts – Visual Resources

Field review conducted from July 2017 to July 2020 confirmed the results of the lidar viewshed analysis. Much of the inland portions of the SRWF VSA were found to be screened from view of the SRWF by vegetation and buildings/structures. Open views toward the SRWF, as indicated by visibility of the ocean, were concentrated within 1 mi (1.6 km) of the shoreline and were largely restricted to beaches, bluffs, dunes, open fields, salt ponds, road corridors, and cleared residential yards, where lack of foreground trees allowed for unscreened views of the ocean.

Visually sensitive public resources with open views toward the SRWF included several historic sites, lighthouses, state parks/beaches, wildlife refuges, designated scenic areas, and the Cliff Walk National Recreation Trail (see Appendix Q1 for additional details). The historic resources with the highest potential for visibility of the SRWF are those that are situated to take advantage of panoramic ocean views. No open views toward the site were documented from any mainland parks, historic sites, designated scenic areas, conservation lands, or village/town center areas that were more than 1 mi (1.6 km) inland from the ocean.

Moreover, open views toward the SRWF do not necessarily equate to actual visibility. A variety of other factors will limit visibility including weather conditions, waves on the ocean surface, humidity, and air pollution. National Climatic Data Center (NCDC) weather data collected from the Newport and Block Island Stations over the seven-year period from January 1, 2010 to December 31, 2016 indicate that clear skies (0–30 percent cloud cover) occur during daylight hours on average 42 percent of the time. While partly cloudy and cloudy skies do not preclude SRWF visibility, these data suggest that weather conditions could substantially reduce long distance visibility (i.e., from land-based viewpoints) during much of the year. NCDC weather data only report visibility to 10 mi (16.1 km); therefore, BOEM utilized a methodology to evaluate visibility at 20 and 30 nm (23.0 and 34.5 mi, 37.0 and 55.6 km) using the observed visibility out to 10 mi (16.1 km) and a relational algorithm based on relative humidity (Wood et al. 2014). For data collected from the Newport Station, visibility to 20 nm (23.0 mi, 37.0 km) occurred approximately 61 percent of the year during daytime hours, while visibility to 30 nm (34.5 mi, 55.6 km) occurred approximately 35 percent of the year during daytime hours (126 days per year). When considering visibility out to 30 nm (34.5 mi, 55.6 km) seasonal values (the number of days in a given season when visibility extends to 30 nm) range from 21 days in summer to 42 days in winter. These calculations indicate that weather will have a significant influence on visibility from most land-based viewpoints within the SRWF's ZVI.

To evaluate the visual impact of the SRWF, a total of 50 visual simulations were prepared from 40 selected KOPs throughout the ZVI. These KOPs were identified based on consultation with state agencies and tribal representatives and studies prepared by BOEM (2012a, b) that identified visually and culturally sensitive sites with views toward offshore lease areas along the entire Atlantic coast including all of the coastline that falls within the SRWF VSA.). The criteria for the selection of KOPs are provided in Appendix Q1.

CONSTRUCTION AND OPERATIONS PLAN

Site Characterization and Assessment of Impacts – Visual Resources

The visual impact of the SRWF were evaluated using the VIA procedure outlined in the USACE VRAP (Smardon et al. 1988). The VIA uses representative KOPs within each of the affected LSZs in the SRWF VSA to determine the Project's visual impact. To provide a balanced evaluation, five rating panel members were used in the evaluation of visual impacts. This evaluation is based on a comparison of existing photos and visual simulations from each viewpoint to quantify the effect of a project using forms and a scoring system provided in the VRAP Manual (Smardon et al. 1988).

The same panel of five visual professionals that completed the MCS procedure for this study also conducted the VIA procedure. As with the MCS evaluation, panel members were provided with digital files of the existing conditions photos and simulations of the proposed Project for each of the simulations, along with a viewpoint information page that provided a viewpoint location map, contextual photographs illustrating a full field of view, and summary information regarding each viewpoint (including viewing instructions). The distance and direction of the SRWF from each viewpoint, and the LSZ, viewer groups, and sensitive resources represented by each viewpoint were provided to the panel (see Appendix Q1) along with the rating forms to be used for the visual impact assessment (a simplified version of Form 6 from the USACE VRAP. The rating panel members viewed the simulations on screen. Each of the visual simulations presented to the panel contained a graphic scale measuring one inch long. The rating panel members were instructed to use a measuring device to ensure this scale bar was accurate, thus ensuring the proper scale of the simulation. In addition, due to the distance and scale of the Project in many of the visual simulations, the panel members were instructed to zoom into the visual simulations to a maximum of 150 percent to locate and view the SRWF. The rating panel members then evaluated the before and after views from each viewpoint and assigned each view quantitative aesthetic quality ratings. The ratings were based on the visual quality of each of the six landscape components (landform, water resources, vegetation, land use, user activity, and special considerations).

Landscape, viewer, and Project-related factors considered by the rating panel in their evaluation are provided in Appendix Q1.

Following the panel's evaluation, each panel member's ratings were compiled to determine individual scores for each viewpoint. The five individual ratings were then averaged to generate a composite rating for each viewpoint.

Rating panel VRAP scores for the compatibility, scale contrast, and spatial dominance of the SRWF at each KOP were also used to inform conclusions regarding visual prominence, noticeability, and contrast. In addition, to supplement and validate VRAP results, rating panel members were asked to determine the Visibility Threshold Level (VTL) applicable to each of the KOPs and the broader regional landscape they represent. Offshore Wind Turbine Visibility and Visual Impact Threshold Distances (Sullivan et al. 2013) lists six VTLs used to rate the visual prominence of several operational offshore wind farms in Europe. The VTL scores and descriptions are presented in Appendix Q1.

Information regarding each selected viewpoint is detailed in the full text of the VIA in Appendix Q1. Additionally, graphic depictions showing locations of the selected KOPs are illustrated in Appendix Q1, Figure 2.2-1. Table 4.5.1-5 presents the results of the rating panel evaluation.

CONSTRUCTION AND OPERATIONS PLAN

Site Characterization and Assessment of Impacts – Visual Resources

Table 4.5.1-5 Visual Impact Assessment Rating Panel Results

ID	Key Observation Point	View Type	Rating Panel Member					Ave	Delta ^{a/}	Landscape Classification	Visibility Threshold Level
			KAC	RCS	JMG	NHR	SMB				
New York											
LI01	Camp Hero State Park Overlook	Existing	10.7	14.7	15.7	14.7	15.7	14.3	-0.6	Retention	1
		Proposed	10.3	14.3	14.7	13.7	15.7	13.7		Retention	
LI04	Montauk Point State Park	Existing	12.7	16.3	17.3	15.0	16.7	15.6	-1.3	Retention	3
		Proposed	12.7	16.3	14.7	13.0	15.0	14.3		Retention	
LI04 NI	Montauk Point State Park - Nighttime	Existing	9.7	8.8	11.8	11.5	13.7	11.1	-1.4	Retention	4
		Proposed	9.3	8.8	9.0	10.2	11.3	9.7		Modification	
Massachusetts											
CI01	Cuttyhunk Island	Existing	14.0	13.7	13.3	16.7	14.7	14.5	-3.1	Retention	4
		Proposed	10.3	13.7	10.7	13.0	9.3	11.4		Partial Retention	
MM01	Gooseberry Island	Existing	15.0	13.3	12.7	13.3	15.0	13.9	-1.3	Retention	2
		Proposed	13.3	13.3	11.7	13.3	11.0	12.5		Partial Retention	
MM04	Nobska Lighthouse	Existing	12.0	16.0	16.3	16.0	16.7	15.4	-0.1	Retention	1
		Proposed	12.0	16.0	16.0	16.0	16.7	15.3		Retention	
MM06	Demarest Lloyd State Park	Existing	11.0	15.0	16.7	14.3	12.3	13.9	-0.3	Retention	2
		Proposed	11.0	15.0	15.7	13.3	12.7	13.5		Retention	
MM07	Fort Taber District	Existing	10.7	14.7	17.3	13.7	14.3	14.1	-0.1	Retention	1
		Proposed	10.7	14.7	17.0	13.7	14.3	14.1		Retention	
MV02	Philbin Beach	Existing	10.5	15.3	15.8	14.8	14.5	14.2	-2.0	Retention	3
		Proposed	9.8	15.3	12.2	13.5	10.2	12.2		Partial Retention	
MV03	Lucy Vincent Beach	Existing	13.3	15.7	16.0	17.0	17.0	15.8	-2.0	Retention	4
		Proposed	12.7	15.7	11.3	14.0	15.3	13.8		Retention	
MV03 SS	Lucy Vincent Beach - Sunset	Existing	13.3	15.7	16.0	17.0	17.0	15.8	-3.5	Retention	5
		Proposed	12.3	15.7	8.3	12.7	12.3	12.3		Partial Retention	
MV05	Moshup Beach	Existing	13.3	15.7	15.3	16.0	16.3	15.3	-3.3	Retention	5
		Proposed	11.7	15.7	9.3	13.0	10.3	12.0		Partial Retention	
MV07	Aquinnah Overlook	Existing	14.0	15.3	16.0	16.7	16.7	15.7	-1.9	Retention	4
		Proposed	12.7	15.3	13.7	13.3	14.3	13.9		Retention	

CONSTRUCTION AND OPERATIONS PLAN

Site Characterization and Assessment of Impacts – Visual Resources

ID	Key Observation Point	View Type	Rating Panel Member					Ave	Delta ^{a/}	Landscape Classification	Visibility Threshold Level
			KAC	RCS	JMG	NHR	SMB				
MV07 SS	Aquinnah Overlook - Sunset	Existing	14.0	15.3	16.0	16.7	16.7	15.7	-3.5	Retention	5
		Proposed	12.7	15.3	9.3	12.7	11.3	12.3		Partial Retention	
MV07 NI	Aquinnah Overlook - Nighttime	Existing	11.8	10.2	13.8	12.5	10.7	11.8	-3.0	Partial Retention	4
		Proposed	9.2	10.2	7.0	10.5	7.3	8.8		Modification	
MV09	Gay Head Lighthouse	Existing	12.7	14.7	17.3	15.7	16.0	15.3	-1.7	Retention	2
		Proposed	12.3	14.7	11.7	13.3	16.0	13.6		Retention	
MV09 SS	Gay Head Lighthouse - Sunset	Existing	12.7	14.7	17.3	15.7	16.0	15.3	-4.3	Retention	5
		Proposed	12.3	14.7	7.0	12.7	8.3	11.0		Partial Retention	
MV10	South Beach State Park	Existing	11.2	15.7	15.2	14.2	13.2	13.9	-2.0	Retention	3
		Proposed	9.8	15.7	10.5	12.5	10.8	11.9		Partial Retention	
MV11	Wasque Point	Existing	12.5	13.3	15.2	14.8	13.8	13.9	-1.3	Retention	3
		Proposed	11.8	13.3	12.2	13.5	12.2	12.6		Partial Retention	
MV12	Peaked Hill	Existing	11.7	13.0	12.7	15.0	11.7	12.8	-0.8	Partial Retention	2
		Proposed	11.7	13.0	12.0	14.0	9.3	12.0		Partial Retention	
MV12 SS	Peaked Hill - Sunset	Existing	11.7	13.0	12.7	15.0	11.7	12.8	-2.7	Partial Retention	5
		Proposed	11.0	13.0	7.0	13.0	6.7	10.1		Modification	
MV13	Edwin D Vanderhoop	Existing	14.3	16.3	17.0	16.7	16.7	16.2	-3.3	Retention	4
		Proposed	13.3	16.3	11.7	11.7	11.3	12.9		Partial Retention	
NI10	Madaket Beach	Existing	10.8	14.7	15.8	14.5	13.0	13.8	-0.4	Retention	1
		Proposed	10.8	14.7	14.8	13.5	13.0	13.4		Partial Retention	
NI10 CL	Madaket Beach – Clear Conditions	Existing	10.8	14.7	15.8	14.5	13.0	13.8	-0.5	Retention	1
		Proposed	10.8	14.7	14.5	13.5	13.0	13.3		Partial Retention	
NL01	Nomans Land Island	Existing	11.3	13.3	16.7	16.0	16.7	14.8	-4.2	Retention	4
		Proposed	11.0	13.3	8.7	11.0	9.0	10.6		Partial Retention	

CONSTRUCTION AND OPERATIONS PLAN

Site Characterization and Assessment of Impacts – Visual Resources

ID	Key Observation Point	View Type	Rating Panel Member					Ave	Delta ^{a/}	Landscape Classification	Visibility Threshold Level
			KAC	RCS	JMG	NHR	SMB				
Rhode Island											
AI01	Brenton Point State Park	Existing	10.7	14.7	16.3	13.3	14.0	13.8	-0.4	Retention	1
		Proposed	10.3	14.0	15.3	13.3	14.0	13.4		Partial Retention	
AI01 NI	Brenton Point State Park - Nighttime	Existing	11.2	9.5	14.3	10.8	13.0	11.8	-2.8	Partial Retention	3
		Proposed	8.5	9.5	10.3	10.3	6.0	8.9		Modification	
AI03	Newport Cliff Walk	Existing	11.8	15.7	16.5	13.8	11.3	13.8	-1.1	Retention	2
		Proposed	10.2	15.7	14.5	12.2	11.2	12.7		Partial Retention	
AI05	Sachuest Point National Wildlife Refuge	Existing	11.7	13.0	14.3	15.0	12.3	13.3	-1.1	Partial Retention	3
		Proposed	10.7	13.0	12.7	12.7	11.7	12.1		Partial Retention	
AI06	Sachuest Beach (Second)	Existing	9.8	14.3	16.7	13.0	12.7	13.3	-0.1	Partial Retention	1
		Proposed	9.8	14.3	16.0	13.0	12.7	13.2		Partial Retention	
AI07	Hanging Rock	Existing	12.3	12.7	11.7	12.0	12.0	12.1	-0.5	Partial Retention	2
		Proposed	11.0	12.7	11.3	12.0	11.3	11.7		Partial Retention	
AI09	Easton's Beach	Existing	10.5	16.0	15.5	14.7	11.7	13.7	-0.2	Retention	1
		Proposed	10.5	16.0	15.2	14.0	11.7	13.5		Retention	
BI02	Great Salt Pond	Existing	10.7	13.3	14.0	11.7	11.2	12.2	0.0	Partial Retention	1
		Proposed	10.7	13.3	14.0	11.7	11.2	12.2		Partial Retention	
BI04	Southeast Lighthouse	Existing	13.0	15.0	16.0	15.0	13.0	14.4	-2.3	Retention	4
		Proposed	12.0	15.0	13.7	13.0	7.0	12.1		Partial Retention	
BI04 SR	Southeast Lighthouse - Sunrise	Existing	13.0	15.0	16.0	15.0	13.0	14.4	-3.5	Retention	6
		Proposed	12.0	15.0	9.3	12.3	6.0	10.9		Partial Retention	
BI04 NI	Southeast Lighthouse - Nighttime	Existing	11.3	9.0	13.0	11.8	12.0	11.4	-3.4	Partial Retention	4
		Proposed	8.8	9.0	8.0	9.8	4.3	8.0		Rehabilitation	
BI06	New Shoreham Beach	Existing	11.2	14.0	13.7	14.7	13.3	13.4	-1.2	Partial Retention	4
		Proposed	10.5	14.0	12.3	12.3	11.7	12.2		Partial Retention	

CONSTRUCTION AND OPERATIONS PLAN

Site Characterization and Assessment of Impacts – Visual Resources

ID	Key Observation Point	View Type	Rating Panel Member					Ave	Delta ^{a/}	Landscape Classification	Visibility Threshold Level
			KAC	RCS	JMG	NHR	SMB				
BI08	Fred Benson Beach	Existing	10.8	14.3	15.2	12.8	12.7	13.2	-0.6	Partial Retention	2
		Proposed	10.2	14.3	12.8	12.8	12.7	12.6		Partial Retention	
BI12	Clayhead Trail	Existing	12.7	13.7	16.3	17.3	15.0	15.0	-3.5	Retention	4
		Proposed	11.0	13.7	12.0	11.3	9.3	11.5		Partial Retention	
BI16	Mohegan Bluffs	Existing	13.2	15.7	13.5	14.2	11.5	13.6	-1.7	Retention	4
		Proposed	11.2	15.7	10.5	11.5	10.8	11.9		Partial Retention	
C01	Beavertail Lighthouse	Existing	10.8	15.7	15.8	14.5	15.5	14.5	-0.4	Retention	1
		Proposed	10.5	15.7	14.2	14.5	15.5	14.1		Retention	
RI01	Watch Hill Lighthouse	Existing	11.7	13.3	16.0	15.0	13.7	13.9	0.0	Retention	1
		Proposed	11.7	13.3	16.0	15.0	13.7	13.9		Retention	
RI02	Weekapaug Breechway	Existing	10.0	13.3	16.0	15.3	11.8	13.3	-0.3	Partial Retention	1
		Proposed	10.0	13.3	15.3	14.3	11.8	13.0		Partial Retention	
RI03	Point Judith Lighthouse	Existing	12.7	15.3	16.7	12.3	15.0	14.4	-2.2	Retention	4
		Proposed	11.7	15.3	11.3	11.3	11.3	12.2		Partial Retention	
RI04	South Shore Beach	Existing	12.3	15.3	16.7	11.3	13.0	13.7	-1.6	Partial Retention	2
		Proposed	12.3	15.3	12.7	10.3	10.0	12.1		Partial Retention	
RI06	Trustom Pond National Wildlife Refuge	Existing	12.7	12.7	15.3	14.7	10.7	13.2	-0.4	Partial Retention	2
		Proposed	12.7	12.7	15.0	13.3	10.3	12.8		Partial Retention	
RI08	Scarborough Beach	Existing	9.2	13.0	15.8	11.5	12.7	12.4	-2.0	Partial Retention	2
		Proposed	8.8	13.0	13.5	9.8	7.0	10.4		Modification	
RI09	Narragansett Beach	Existing	10.5	13.7	15.5	12.5	12.3	12.9	-0.3	Partial Retention	1
		Proposed	10.5	13.7	14.5	11.8	12.3	12.6		Partial Retention	
RI11	East Matunuck Beach	Existing	10.2	15.0	15.2	12.2	13.2	13.1	-1.4	Partial Retention	4
		Proposed	9.5	15.0	12.5	11.2	10.5	11.7		Partial Retention	

CONSTRUCTION AND OPERATIONS PLAN

Site Characterization and Assessment of Impacts – Visual Resources

ID	Key Observation Point	View Type	Rating Panel Member					Ave	Delta ^{a/}	Landscape Classification	Visibility Threshold Level
			KAC	RCS	JMG	NHR	SMB				
RI12	Ninigret National Wildlife Refuge	Existing	9.3	13.0	14.7	13.0	13.0	12.6	0.0	Partial Retention	1
		Proposed	9.3	13.0	14.7	13.0	13.0	12.6		Partial Retention	

NOTES:
a/ **Bold numbers** in the Delta column indicate a viewpoint that met or exceeded the threshold for potential adverse visual impacts. Delta Thresholds Applied to Landscape Classes: Preservation Class – 0, Retention Class – No lower than minus 2, Partial Retention Class – No lower than minus 5, Modification Class – No lower than minus 6 Rehabilitation Class – Greater than 0

Based on the results of the rating panel evaluation, with the proposed Project in place, the visual impact threshold was exceeded at nine KOPs in Massachusetts and three KOPs in Rhode Island (see Appendix Q1, Section 3.2.3). These KOPs include Cuttyhunk Island, Philbin Beach, Lucy Vincent Beach, Moshup Beach, Aquinnah Overlook, Gay Head Lighthouse, South Beach State Park, Edwin D. Vanderhoop House (the Aquinnah Cultural Center), and Nomans Land Island in Massachusetts and Clayhead Trail, Point Judith Lighthouse, and Southeast Lighthouse in Rhode Island. All of the KOPs where rating panel evaluation indicated a level of visual impact that exceeded the allowable threshold were determined to be Retention Class landscapes (i.e., the existing views from the individual KOPs received MCS scores in the range of 14 to 16). Simulations showing views of the Project in place from these KOPs resulted in a reduction of between 2.3 and 4.3, thus exceeding the threshold of minus 2 and reducing the MCS classification of these KOPs to Partial Retention (see Appendix Q1, Table 3.2-3). These results indicate that the SRWF will likely result in significant visual impact to these KOPs under clear viewing conditions.

The KOPs that exceeded the threshold for visual impacts generally have several factors in common that contributed to potentially adverse visual impacts to onshore resources associated with the KOPs. For example, each of these views has a relatively high baseline scenic quality, most of the views presented an ocean view with very little evidence of human activity present in the view, many of the views occurred at a prominent location with a commanding view of the ocean, and finally, all of the views illustrated the turbines under clear conditions with the WTG strongly backlit against a relative light sky. Generally, the distances ranged from 16.9 mi (27.2 km) to 22.0 mi (35.4 km) and include the closest available onshore viewing locations from the SRWF. However, one view (Cuttyhunk Island) is 25.8 mi (41.5 km) from the SRWF. In the case of Cuttyhunk Island the combination of viewer height [151.3 ft (46.1 m)], the light sky at the horizon, and the backlighting of the turbines results in optimal, high visibility viewing conditions.

CONSTRUCTION AND OPERATIONS PLAN

Site Characterization and Assessment of Impacts – Visual Resources

Generally, there is a strong correlation between viewing distance and visual impact. With the exception of the previously mentioned Cuttyhunk Island, the reduction in scenic quality resulting from the SRWF is significantly reduced at distances beyond 25 mi (40.2 km) due to the lack of scale contrast and spatial dominance presented by the WTGs (Figure 4.5.1-7). Additionally, the compatibility of the SRWF with vegetation, water resources, landform, land use, and user activity significantly increase as the viewing distance increases beyond 25 mi (40.2 km). Beyond 30 mi (48.3 km), the decrease in scenic quality never exceeds 1.5 and the baseline scenic quality never exceeds that of a retention class landscape, suggesting that the visual impacts are well within the range of acceptable thresholds for all KOPs beyond 30 mi (48.3 km).

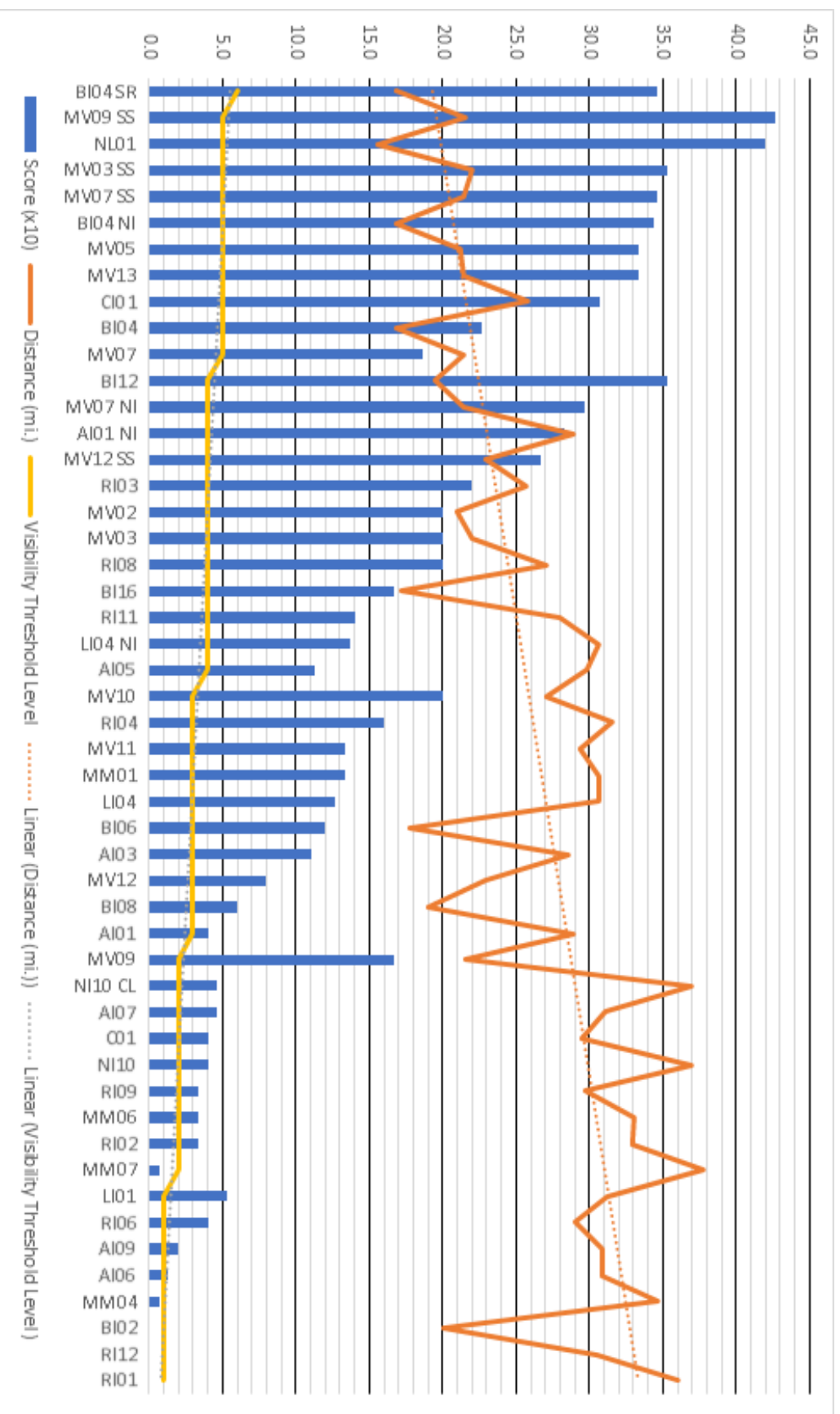

Figure 4.5.1-7 Relationship Between Distance from SRWF and Visual Impact Score

CONSTRUCTION AND OPERATIONS PLAN

Site Characterization and Assessment of Impacts – Visual Resources

A detailed description of the individual KOPs and the relevant rating panel results is provided in Appendix Q1.

The VTL results suggest a similar pattern to the visual impact results. However, it is important to note that visibility threshold levels do not directly correspond or relate to visual impact levels in every instance. A high level of visibility occurring at a viewpoint with minimal use or of relatively low scenic quality may result in low potential visual impact. As such, lower visual impact rating scores (i.e., greater visual impact as determined by the VRAP) will likely correlate with increased VTL. However, instances do arise in which a highly visible feature can have a minimal impact if the resource has a relatively low scenic quality baseline or substantially low accessibility. Conversely, a view with high scenic quality and minimal VTL, may experience elevated visual impacts due to the sensitivity of that resource.

One KOP at Southeast Light received a VTL of 6 as a result of proximity to the SRWF and high contrast lighting conditions at sunrise. VTL 6 suggests, an object/phenomenon with strong visual contrasts that is so large that it occupies most of the visual field, and views of it cannot be avoided except by turning one's head more than 45 degrees from a direct view of the object. The object/phenomenon is the major focus of visual attention, and its large apparent size is a major factor in its view dominance. In addition to size, contrasts in form, line, color, and texture, bright light sources and moving objects associated with the study subject may contribute substantially to drawing viewer attention. The visual prominence of the study subject detracts noticeably from views of other landscape/seascape elements (Sullivan et al. 2013).

Eight of the KOPs were assigned a VTL of 5 which suggests an object/phenomenon that is not large but contrasts with the surrounding landscape elements so strongly that it is a major focus of visual attention, drawing viewer attention immediately and tending to hold that attention. In addition to strong contrasts in form, line, color, and texture, bright light sources such as lighting and reflections and moving objects associated with the study subject may contribute substantially to drawing viewer attention. The visual prominence of the study subject interferes noticeably with views of nearby landscape/seascape elements (Sullivan et al. 2013). These KOPs range in distance from 15.6 to 25.8 mi (25.1 to 41.5 km) and averaged 20.5 mi (33.0 km) from the nearest SRWF WTG. These KOPs generally illustrated high contrast conditions including one nighttime condition from Southeast Light and the sunset conditions from Martha's Vineyard (See Inset 3.2-1 above).

Twelve of the KOPs were assigned a VTL of 4 which suggests an object/phenomenon that is obvious and with sufficient size or contrast to compete with other landscape/seascape elements, but with insufficient visual contrast to strongly attract visual attention and insufficient size to occupy most of an observer's visual field (Sullivan et al. 2013). These KOPs range in distance from 17.2 to 30.6 mi (27.7 to 49.2 km) and averaged 24.5 mi (39.4 km) from the nearest SRWF WTG. Three of these KOP illustrate nighttime conditions from Aquinnah Overlook, Brenton Point State Park, and Montauk Point. The remaining KOPs occur on Aquidneck Island, Martha's Vineyard, and mainland Rhode Island and generally illustrate the Project under high-contrast conditions (i.e., backlit [See Inset 3.2-1 above]).

CONSTRUCTION AND OPERATIONS PLAN

Site Characterization and Assessment of Impacts – Visual Resources

The SRWF resulted in a VTL of 3 at 10 KOPs, ranging in distance from 17.8 to 31.6 mi (28.6 to 50.9 km) and averaging approximately 26.7 mi (43.0 km) from the nearest SRWF WTG. VTL 3 states, views include an object/phenomenon that can be easily detected after a brief look and would be visible to most casual observers, but without sufficient size or contrast to compete with major landscape/seascape elements (Sullivan et al. 2013). The KOPs that received a VTL of 3 occur primarily on Martha's Vineyard, mainland Rhode Island and Massachusetts, and more distant locations on Aquidneck Island and Block Island (See Inset 3.2-1 above).

Eight KOPs were assigned a VTL of 2 and ranged in distance from 21.6 to 37.8 mi (34.8 to 60.8 km) from the SRWF. The average distance of these KOPs from the SRWF was 32.2 mi (51.8 km) and included KOPs on Nantucket, Aquidneck Island, Martha's Vineyard, Portsmouth Island, and mainland Rhode Island (See Inset 3.2-1 above). VTL 2 states an object/phenomenon that is very small and/or faint, but when the observer is scanning the horizon or looking more closely at an area, can be detected without extended viewing. It could sometimes be noticed by casual observers; however, most people would not notice it without some active looking (Sullivan et al. 2013).

KOPs that received a VTL of 1 ranged in distance from 20.1 to 36.0 mi (32.3 to 57.9 km) from the nearest SRWF WTG. The closest of these KOPs includes Great Salt Pond, which is 20.1 mi (32.3 km) from the nearest SRWF WTG. At this distance, an object/phenomenon is near the extreme limit of visibility. It could not be seen by a person who was unaware of it in advance and looking for it. Even under those circumstances, the object can be seen only after looking at it closely for an extended period regardless of high contrast visibility (Sullivan et al. 2013). VTL 1 occurred at three KOPs ranging from 20.1 to 36.0 mi (32.3 to 57.9 km). These KOPs occur most frequently on Mainland Rhode Island, and Long Island.

Lighting and Marking

The proposed WTGs will be equipped with both AOLs on top of each nacelle and USCG navigation lights on the platform near the tower base. The turbine will be painted a light grey (RAL 7035) to pure white (RAL 9010) to eliminate the need for daytime lighting or further turbine marking for daytime conspicuity. To evaluate the potential visibility and visual impact of these new lights, the VIA included a viewshed analysis based on the anticipated height and locations of the aviation warning lights, as well as nighttime visual simulations from selected KOPs where the aviation warning lights were anticipated to be visible.

The nighttime viewshed analysis was conducted in the same manner as the daytime analysis but was based on a height of 597 ft (182 m), where the aviation warning lights would be mounted on the nacelles. The nighttime viewshed analysis suggests that aviation lighting will be visible from approximately 3.4 percent of the land area in the 40-mi (64-km) SRWF VSA (Table 4.5.1-6 and Appendix Q1 – Figure 3.1-1). This reduction in visibility can be attributed to the lower height of the aviation lights (relative to the WTG blade tips) combined with the screening effects of curvature of the Earth. Areas in which the aviation lights are screened by curvature of the Earth include Montauk Point and Ditch Plains Beach on Long Island, the south-central and southeastern beaches on Martha's Vineyard, and all the shoreline in the Town of Westerly, RI, on the mainland. In each of these areas, the blade tip analysis indicated potential visibility, but the nighttime viewshed indicated lack of visibility.

CONSTRUCTION AND OPERATIONS PLAN

Site Characterization and Assessment of Impacts – Visual Resources

Table 4.5.1-6 Aviation Obstruction Lights – Land Area Viewshed Results Summary

Distance from the SRWF	40 Mile Radius Study Area (Units in Square Miles)		
	Total Land Area	Land Area with Potential Visibility	Percent of VSA
0 to 10 mi (0 to 16 km)	0	0	0
10 to 20 mi (16 to 32 km)	15.0 (38.8 km ²)	3.1 (2.6 km ²)	20.9
20 to 30 mi (32 to 48 km)	159.7 (413.6 km ²)	13.5 (35.0 km ²)	8.4
30 to 40 mi (48 to 64 km)	527.0 (1364.9 km ²)	7.4 (19.2 km ²)	1.4
Total 40-mi (64-km) Landward Study Area	701.7 (1817.4 km ²)	24.0 (62.2 km ²)	3.4

Nighttime visual simulations were prepared for four of the selected KOPs, as indicated in Table 4.5.1-7. As with daytime viewpoints, the rating panel's evaluation of nighttime visual impacts was variable depending on what other sources of lighting are present in the view, the extent of screening provided by buildings/structures and trees, and nighttime viewer activity/sensitivity. Composite scores for nighttime simulations ranged from minus 3.4 to 1.4 and averaged minus 2.7. While night lighting will likely have an adverse effect on residents and vacationers in settings where they currently experience dark nighttime skies, in many places nighttime visibility/visual impact will be limited due to: 1) the abundance of trees that screen all or portions of the Project from the majority of homes within the VSA; 2) the existing shoreline and offshore light sources that already impact nighttime ocean views; 3) the distance of the Project from mainland viewpoints; and 4) the concentration of residences in villages, town centers, and neighborhoods, or along highways, where existing lights already compromise dark skies and compete for viewer attention. However, AOLs are visible at distances greater than 24 mi (38.6 km) based on nighttime observations of operational offshore wind farms in Europe (Sullivan et al. 2013). The simulations and rating panel result suggest elevated nighttime visual impacts will occur to KOPs ranging in distance from 16.9 to 30.6 mi (27.2 to 49.2 km) from the SRWF. However, all of the nighttime visual simulations received a VTL of 4, which suggests the AOLs may have a visual effect over greater distances than suggested by the aforementioned study. It is important to note that the simulations presented to the rating panel consider ideal viewing conditions, which according to the meteorological study may only occur during 33 days of a given year.

Table 4.5.1-7 Viewpoints Selected for Nighttime Visual Simulations

KOP	Viewpoint Name	Location	Latitude, Longitude (WGS 84)
New York			
LI04	Montauk Point State Park	Town of East Hampton, Suffolk County	41.0721° N, 71.8590° W
Massachusetts			
MV07	Aquinnah Overlook	Town of Aquinnah, Dukes County	41.3473° N, 70.8370° W
Rhode Island			
AI01	Brenton Point State Park	Town of Newport, Newport County	41.4504° N, 71.3548° W
BI04	Southeast Lighthouse	Town of New Shoreham, Washington County	41.1528° N, 71.5519° W

CONSTRUCTION AND OPERATIONS PLAN

Site Characterization and Assessment of Impacts – Visual Resources

To prepare nighttime simulations, data on the proposed aviation obstruction warning lights were collected from BOEM's *Guidelines for Lighting and Marking of Structures Supporting Renewable Energy Development* (BOEM 2021), which provides guidelines for the lighting of WTGs. In addition, views of the operational Block Island Wind Farm were documented to determine the appearance of the aviation lights at night at distances beyond 20 mi (32.2 km). Computer modeling and camera alignment for the nighttime photos were prepared in the same manner described for the daytime simulations. It was assumed that all lights will flash in a synchronized manner, as currently recommended by FAA guidelines. The lights will consist of two L-864 medium intensity red lights mounted on the nacelle and up to three L-810 low intensity red lights mounted on the midsection of the WTG tower at a height of approximately 312 ft (95 m). All lights will have a synchronous flash rate of 30 flashes per minute (FPM). Nighttime simulations therefore show all WTGs with their lights on. Due to the effects of the curvature of the Earth and refraction, USCG navigation lights on the WTGs were only considered in views that had a direct line of sight to the foundation transition, which is approximately where the USCG navigation lights will be located.

Sunrise Wind is evaluating the implementation of methods to limit the visual impact of the aviation light, for example light dimming or the use of radar-based ADLS to turn on, and off, the aviation obstruction lights in response to detection of aircraft in proximity to the SRWF, pursuant to approval by the FAA, commercial and technical feasibility at time of FDR/FIR approval, and dialogue with stakeholders.

Sunrise Wind will use ADLS or related means (e.g., dimming or shielding) to limit visual impact, pursuant to approval by the FAA and BOEM and commercial and technical feasibility at the time of FDR/FIR approval.

While night lighting could potentially have an effect on residents and vacationers in settings where they currently experience dark nighttime skies, in many places, nighttime visibility/visual impact will be limited due to: (1) the abundance of trees that screen all or portions of the SRWF from the majority of visual resources within the SRWF VSA, (2) the existing shoreline and offshore light sources that already impact nighttime ocean views, (3) the distance of the SRWF from mainland viewpoints, (4) the concentration of residences in villages, town centers, and neighborhoods, or along highways, where existing lights already compromise dark skies and compete for viewer attention, and (5) the installation of ADLS or related means. Assuming the implementation of ADLS or related technologies, it is anticipated that nighttime visual impacts to onshore resources will be temporary and intermittent in nature. However, during the time that the aviation lights are active, some onshore resource may experience significant visual impacts. The level of visual impact is highly dependent on the distance from the SRWF and the presence of existing onshore and offshore light sources.

Sunrise Wind Export Cable–NYS

Construction of the SRWEC–NYS could result in temporary, short-term visual impacts to onshore visual resources due to the presence of heavy construction equipment located within the near-shore zone adjacent to the landing site off Fire Island National Seashore. The effects to onshore visual resources are limited to the window in which the construction activities are occurring and are visible to those recreating in the vicinity of the viewshed. Therefore, the effects are expected to be limited and short-term.

CONSTRUCTION AND OPERATIONS PLAN

Site Characterization and Assessment of Impacts – Visual Resources

Onshore Facilities

Construction

Construction of the OnCS–DC will occur at the Union Avenue Site. The maximum area of land disturbance will be approximately 8 ac (3.2 ha), and the final footprint of the OnCS–DC will be approximately 6 ac (2.4 ha). The remaining area will be used for construction staging/laydown areas and will be stabilized and restored after construction is complete. The OnCS–DC construction will require tree clearing, grading, and excavation within the total construction footprint of the OnCS–DC over a construction period of approximately 24 months. Once the construction of the OnCS–DC is complete, the remaining temporary workspace locations will be stabilized and restored, including the installation of any proposed landscaping/screening.

Construction of the Onshore Transmission Cable will involve site preparation, duct bank installation, cable installation, cable jointing, final testing, and site restoration with additional steps associated with HDD and other trenchless crossing methods. The effects to onshore visual resources are limited to the window in which construction activities are occurring and visible to those in the vicinity of the viewshed. Therefore, the effects are expected to be limited and short-term.

Traffic

Construction of the OnCS–DC will result in the temporary increase of vehicular traffic patterns in locations close to the OnCS–DC site. It is anticipated that minimal visual effects will result from increased traffic during construction of the OnCS–DC due to the localized and temporary nature of the construction traffic in a generally industrial area.

Visible Infrastructure

Construction of the OnCS–DC will occur near the existing Holbrook Substation in an area surrounded by industrial and commercial developments. General activities include clearing and grading, excavation, installation of foundations, and construction of the facility. Generally, the construction activities will result in localized visual impacts within a largely industrial area. Site clearing, site grading, and construction of the OnCS–DC will likely result in visual change to viewers and users that are familiar with the area, but these types of visual alterations are common along Union Avenue. Certain users, such as bikers and runners that use the Suffolk County Central Corridor Bike Route which runs along Union Avenue, are likely to notice visual changes during construction. However, the impacts associated with construction will be temporary in nature and operation of the facility will be consistent with the surrounding land use types, such that it will not significantly impact the enjoyment of the resources adjacent to the site.

Lighting and Marking

Construction of the OnCS–DC will typically involve work during daylight hours and the installation of temporary security and safety lighting if work at night is necessary. As a result, it is anticipated that lighting associated with construction activities will not result in impacts to visual resources.

CONSTRUCTION AND OPERATIONS PLAN

Site Characterization and Assessment of Impacts – Visual Resources

Operations and Maintenance

IPFs associated with the operational OnCS–DC are likely to only include visible infrastructure due to the nature of the existing visual landscape within the OnCS–DC VSA. Increased traffic associated with routine maintenance of the OnCS–DC in this heavily populated area will not result in impacts to visual resources.

Facility lighting will be required for the safe and secure operation of the OnCS–DC. However, the light sources are expected to be lower in profile than the maximum heights used in the viewshed analysis. Additionally, the OnCS–DC is being proposed in a developed site, currently occupied by various commercial industries/small businesses, and with numerous existing light sources, highway traffic, and visual distractions. Due to the developed nature of this area, the lights associated with the OnCS–DC are not expected to contribute significantly to the existing sky glow or light trespass resulting from existing light sources present in the area. Therefore, it is anticipated that minimal visual effects will result from facility lighting.

Visible Infrastructure

A lidar viewshed analysis was completed to determine the areas within the 3-mi (4.8-km) OnCS–DC VSA that may have visibility of the OnCS–DC. Results of this analysis suggested that only 1.8 percent of the 3-mi (4.8-km) VSA would have visibility of a portion of the OnCS–DC. Of the 55 VSRs identified in the OnCS–DC VSA, 17 occur with the ZVI. Table 4.5.1-8 provides a summary of the VSRs with potential visibility of the OnCS–DC.

Table 4.5.1-8 Visually Sensitive Resources with Potential OnCS–DC Visibility (Within OnCS–DC ZVI)

Visually Sensitive Resources	Total Number of Resources within the VSA	Total Number of Resources with Visibility
Properties of Historic Significance	Total 2	Total 0
Properties Listed in National or State Registers of Historic Places (NRHP/SRHP)	1	0
Properties Eligible for Listing in NRHP or SRHP	1	0
Designated Scenic Resources	Total 0	Total 0
Rivers Designated as National or State Wild, Scenic, or Recreational	0	0
Adirondack Park Scenic Vistas (Adirondack Park Land Use and Development Map)	0	0
Sites, Areas, Lakes, Reservoirs or Highways Designated or Eligible for Designation as Scenic (ECL Article 49 Title 1) or equivalent)	0	0
Scenic Areas of Statewide Significance (Article 42 of Executive Law)	0	0
Other Designated Scenic Resources (Easements, Roads, Districts, and Overlooks)	0	0
Public Lands and Recreational Resources	Total 24	Total 9
National Parks, Recreation Areas, Seashores, and/or Forests (16 U.S.C. 1c)	0	0
National Natural Landmarks (36 CFR Part 62)	0	0
National Wildlife Refuges (16 U.S.C. 668dd)	0	0

CONSTRUCTION AND OPERATIONS PLAN

Site Characterization and Assessment of Impacts – Visual Resources

Visually Sensitive Resources	Total Number of Resources within the VSA	Total Number of Resources with Visibility
Heritage Areas (Parks, Recreation and Historic Preservation Law Section 35.15)	1	1
State Parks (Parks, Recreation and Historic Preservation Law Section 3.09)	0	0
State Nature and Historic Preserve Areas (Section 4 of Article XIV of the State Constitution)	0	0
State Forest Preserves (NYS Constitution Article XIV)	0	0
Other State Lands	0	0
Wildlife Management Areas & Game Refuges	0	0
State Forests	0	0
State Boat Launches/Waterway Access Sites	0	0
Designated Trails	6	4
Palisades Park (Palisades Interstate Park Commission)	0	0
Local Parks and Recreation Areas	13	4
Publicly Accessible Conservation Lands/Easements	1	0
Rivers and Streams with Public Fishing Rights Easements	0	0
Named Lakes, Ponds, and Reservoirs	3	0
High-Use Public Areas	Total 29	Total 8
State, US, and Interstate Highways	7	3
Cities, Villages, Hamlets	8	4
Schools	14	1
Total Number of Visually Sensitive Resources in the VSA	55	17

Visually sensitive resources with potential visibility of the OnCS–DC include the Long Island North Shore State Heritage Area, four designated bike trails, four local parks or recreation areas, three highways, four hamlets, and one school.

Additional Information regarding potential visibility from these resources is detailed in Appendix Q2.

Field verification suggests that the areas of potential visibility of the proposed OnCS–DC would be significantly less frequent than suggested by the viewshed analysis. Longer-distance views throughout the VSA are limited and in most places obstructed by mature vegetation, which generally occurs along most streets and in neighborhoods. The viewshed analysis does not consider the screening provided by roadside vegetation due to the frequent presence of overhead utility lines, which appear in the analysis as screening features if not removed. Other factors that will limit the actual visibility of the proposed OnCS–DC include the narrow, slender profile of the masts, which do not generally attract viewer attention, particularly when viewed amongst foreground to background mature vegetation.

CONSTRUCTION AND OPERATIONS PLAN

Site Characterization and Assessment of Impacts – Visual Resources

In summary, throughout most of the VSA, the proposed OnCS–DC is not anticipated to be visible due to densely situated buildings and houses in the villages, and dense, mature evergreen and deciduous forest in the surrounding areas. Potential visibility of the OnCS–DC will be generally limited to a few areas within approximately 0.25 mi (0.4- km) of the site. Where visible, it is expected that views of the proposed OnCS–DC from most of these areas would be limited to the uppermost portions of the proposed lightning masts.

4.5.1.3 Proposed Environmental Protection Measures

Sunrise Wind will implement the following environmental protection measures to reduce potential impacts on visually sensitive resources. These measures are based on protocols and procedures successfully implemented for similar projects.

- WTGs will have uniform design, height, and rotor diameter.
- The WTGs will be painted no lighter than Pure White (RAL 9010) and no darker than Light Grey (RAL 7035) as recommended by BOEM and the FAA. Turbines of this color white generally blend well with the sky at the horizon and eliminate the need for daytime warning lights or red paint marking of the blade tips.
- The WTGs and OCS–DC will be lit and marked in accordance with BOEM and USCG requirements for aviation and navigation obstruction lighting, respectively.
- The WTGs will be lit and marked in accordance with FAA Advisory Circular 70/7460-1L (2018), as recommended by BOEM's *Guidelines for Lighting and Marking of Structures Supporting Renewable Energy Development* (BOEM 2021).
- Sunrise Wind will use ADLS or related means (e.g., dimming or shielding) to limit visual impact, pursuant to approval by the FAA and BOEM, commercial and technical feasibility at the time of FDR/FIR approval, and dialogue with stakeholders.
- The construction of the Landfall and ICW HDD is expected to occur outside the summer tourist season, which is generally between Memorial Day and Labor Day. The construction schedule for the remaining Onshore Facilities will be designed to minimize impacts to the local communities to the extent feasible.
- The Onshore Transmission Cable and Onshore Interconnection Cable will not include any overhead utility poles, thus minimizing potential impacts to adjacent properties.
- The OnCS–DC is sited near an existing substation on a parcel zoned for commercial and industrial/utility use.
- Screening will be implemented at the OnCS–DC to the extent feasible, to reduce potential visibility and noise.

CONSTRUCTION AND OPERATIONS PLAN

Site Characterization and Assessment of Impacts – Cultural Resources

4.6 Cultural Resources

4.6.1 Marine Archaeological Resources

This section describes the affected environment and potential effects from the construction and operation of the Project as they relate to MARs. The description of the affected environment and assessment of potential impacts were developed by reviewing current public data sources related to MARs, including state and federal agency-published papers and databases (e.g., the BOEM Archaeological Resource Information Database [2013], NOAA's Wrecks and Obstructions Database [2016], and the NYSHPO CRIS [2020]); online data portals and mapping databases, environmental studies (NCEI 2020), published scientific literature relating to the geologic and historic contexts of marine components of the Project Area, and correspondence and consultation with federal and state agencies and Native American tribes. Specific requirements for submittal of MARs information within this COP are provided in BOEM's *Guidelines for Providing Archaeological and Historic Property Information pursuant to 30 CFR Part 585* (BOEM 2020). A description of the MARs within the SRWF and SRWEC is provided below, followed by an evaluation of potential Project-related impacts. The offshore components of the Project are located within federal waters on the OCS and NYS waters. The onshore components of the Project are located in the Town of Brookhaven, NY and include the Onshore Transmission Cable ICW HDD.

The Preliminary Area of Potential Effects (PAPE) for potential direct impacts to MARs is defined as the area encompassing all proposed seabed disturbances associated with the offshore components of the Project (i.e., SRWF and SRWEC) and the ICW HDD (Figure 4.6.1-1 and Figure 4.6.1-2).

The Project design is under active development and Sunrise Wind anticipates refinement of the PAPE based on ongoing feasibility and constraints analyses. Any changes to the PAPE will be incorporated into subsequent revisions to the *Marine Archaeological Resources Assessment* (Appendix R) and the COP, to ensure appropriate analyses and to support the consideration of potential impacts/effects to submerged historic properties that may be affected by the Project.

The PAPE is based on the maximum design scenario under the PDE and includes potential temporary workspaces, areas of potential seabed preparation, anchorage areas, and areas subject to seabed impacts from construction of the SRWF and SRWEC. The vertical dimensions of the PAPE within the proposed SRWF extend from the existing seafloor to a maximum embedment depth of approximately 295 ft (90 m) for installation of the OCS–DC piled jacket foundation. The horizontal limits of the SRWF section of the PAPE extend a maximum width (east-west) of approximately 23.8 mi (38.3 km) and a maximum length (north-south) of approximately 11.2 mi (18 km). Sediment displacement at depths exceeding 15 feet (4.7 m) would be restricted to activities occurring at foundation locations or the associated temporary workspaces where jack-up vessels or other spudding is expected. The section of the PAPE encompassing the SRWEC–OCS varies between 1,312 ft and 2,625 ft (400 and 800 m) in width to accommodate flexibility in the final cable alignment and deconfliction. With the exception of the proposed Landfall HDD exit pit, the vertical dimensions of the SRWEC section of the PAPE extend from the existing seafloor to a maximum depth of 15 ft (4.7m) based on potential anchorage activities. Seabed disturbance may extend to a maximum depth of 16 ft (5 m) within the Landfall HDD workspaces.

CONSTRUCTION AND OPERATIONS PLAN

Site Characterization and Assessment of Impacts – Cultural Resources

The maximum depth of disturbance for the ICW HDD is 78 ft (23.8 m) based on the 3 ft (0.9 m) diameter of the cable ducts and a target burial depth of 75 ft (22.9 m). Additional details on the depths of disturbance associated with specific construction activities are provided in Section 4.6.1.2.

The formal determination of the APE, per 36 CFR 800.4(a)(1), will occur once BOEM accepts the Project's COP consistent with 30 CFR 585 et seq. More detailed information concerning MARs is presented in Appendix R, under confidential cover.

Figure 4.6.1-1
Sunrise Wind Farm
Marine Archaeology PAPE

Sunrise Wind | Powered by Ørsted & Eversource

- Legend
- Indicative Turbine Layout (WTG)
 - Indicative Offshore Converter Station (OCS-DC)
 - Sunrise Wind Export Cable (SRWEC-OCS)
 - Sunrise Wind Export Cable (SRWEC-NYS)
 - ▭ Sunrise Wind Farm (SRWF)
 - ▨ Sunrise Wind Farm (SRWF)
 - ▨ Preliminary Area of Potential Effects (PAPE)

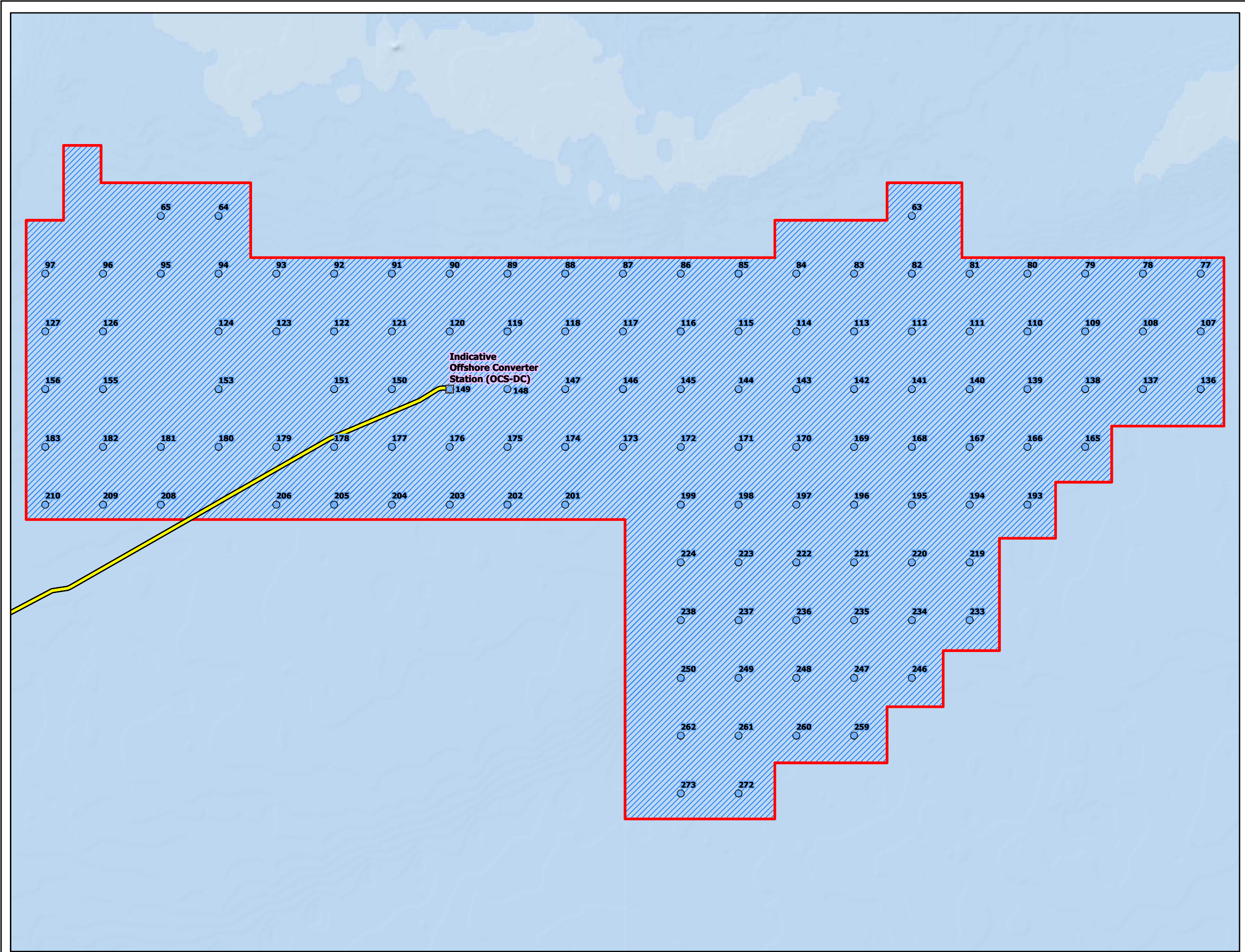

Note
 Routes are Indicative and subject to engineering design changes.

Sources
 1. World Ocean Base (ESRI, DeLorme, NaturalVue, GEBCO)

Date	8/23/2021
Project Number	2028113199
Prepared By	KFM
Reviewed By	

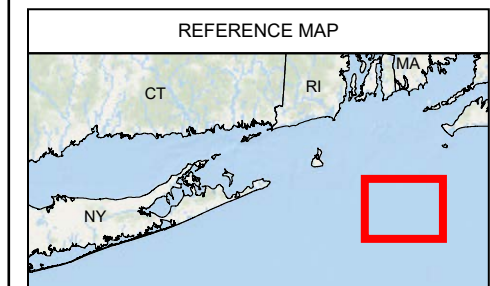
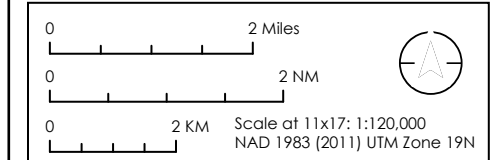

This page intentionally left blank

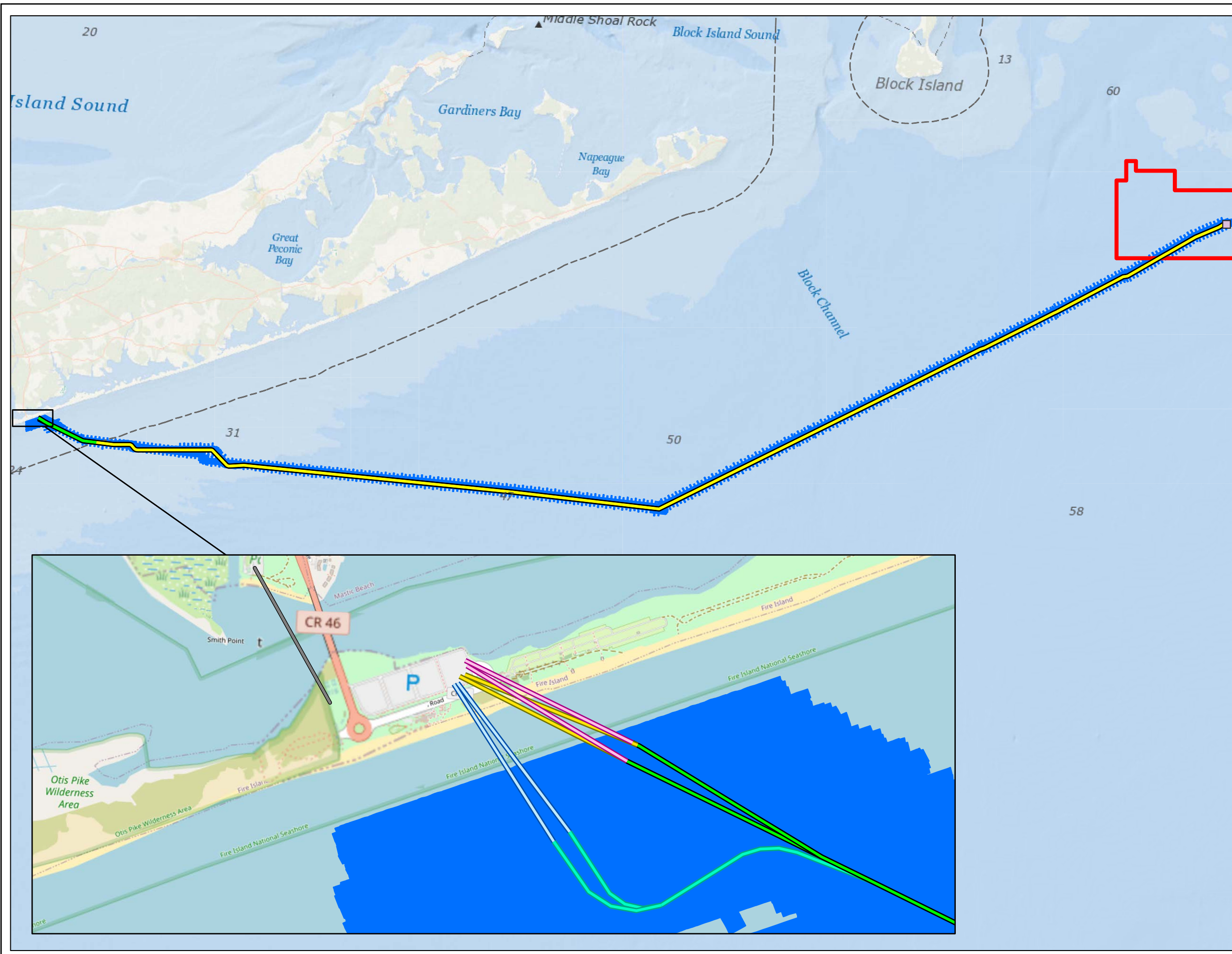

Figure 4.6.1-2
Sunrise Wind Export Cable
Marine Archaeology PAPE
Sunrise Wind | Powered by Ørsted & Eversource

- Legend
- Indicative Offshore Converter Station (OCS-DC)
 - Sunrise Wind Export Cable (SRWEC-OCS)
 - Sunrise Wind Export Cable (SRWEC-NYS)
 - SRWEC-NYS (Western Landfall Option)
 - Intracoastal Waterway HDD
 - Landfall HDD A
 - Landfall HDD B
 - Landfall HDD C
 - State / Federal Boundary (BOEM, SLA)
 - Sunrise Wind Export Cable (SRWEC)
 - Preliminary Area of Potential Effects (PAPE)
 - Sunrise Wind Farm (SRWF)

Note
 SRWEC route will have one landfall location. Routes are Indicative and subject to engineering design changes.

- Sources**
1. World Ocean Base (ESRI, DeLorme, NaturalVue, GEBCO)
 2. World Ocean Reference (NOAA OCS, ESRI, DeLorme)
 3. OpenStreetMap (OpenStreetMap and contributors, CC-BY-SA)

Date	8/23/2021
Project Number	2028113199
Prepared By	KFM
Reviewed By	

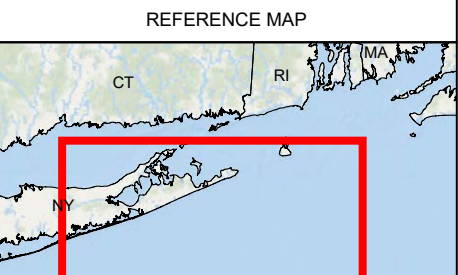
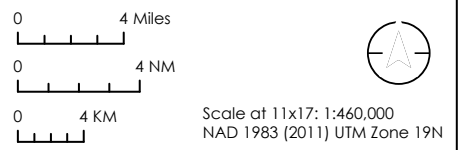

This page intentionally left blank

CONSTRUCTION AND OPERATIONS PLAN

Site Characterization and Assessment of Impacts – Cultural Resources

4.6.1.1 Affected Environment

Regional Environment

BOEM has established that MARs consist of (1) historic period sites such as shipwrecks and associated remains, sunken aircraft, and other maritime infrastructure; and (2) pre-contact archaeological sites once part of the terrestrial landscape and since inundated by global sea level rise during the late Pleistocene and Holocene (BOEM 2020). MARs from both the Pre-Contact and Post-Contact Periods²⁰ are expected within the Project PAPE. Pre-contact MARs include potentially archaeologically sensitive landscapes, now submerged, that would have supported human occupation prior to marine transgression. During the ensuing glacial retreat, pro-glacial lakes formed in front of the retreating glacier as the outflowing glacial meltwater was dammed behind moraines (Poppe et al. 2012). These lakes and their associated braided fluvial systems that flowed south would have provided resource-rich areas for potential human populations seeking freshwater sources for productive hunting and fishing grounds.

By 15,000 years ago, the glacial lakes drained, and sea levels began to rise rapidly, transforming the former lake beds into estuaries and fringing marshlands. When subaerially exposed, these resource-rich environments would have played a vital role in the survival of local populations. Submerged/buried pre-contact cultural resources within the area might include shell middens and resource procurement sites; these archaeological features have the highest probability for preservation along paleolandforms such as submerged paleochannels, natural levees, and inset terraces.

As the sea level rose, it is likely that most of the SRWF and SRWEC areas would have been completely submerged by approximately 10,000 years before present (yBP), when relative sea level would have been about 98.4 ft (30 m) below its present level. The inundation of the offshore portion of the Project at this time eliminates the possibility of any pre-contact occupation sequence earlier than the Paleoindian Period (12,500 to 10,000 yBP), a time when the OCS consisted of open evergreen forests, grasslands, and freshwater swamps. These conditions were ideal for the proliferation of various plant and mammal species, resources needed for the sustenance of small bands of Paleoindian hunters (Ritchie and Funk 1973). Later cultural group sites (e.g., Early/Late Archaic and Woodland Period) may be encountered along portions of the SRWEC. Additionally, early European exploration, increased maritime activity during the following centuries, and post-contact Native American maritime practices all contribute to the maritime historical context of the region and result in a potential for post-contact submerged cultural resources to exist within the PAPE. A review of public data sources was conducted to identify at least 12 charted shipwrecks and/or obstructions within 1 mi (1.6 km) of the SRWF and SRWEC. The number and types of shipwrecks and obstructions will be included in Appendix R following additional research and the review of geophysical survey data.

²⁰ These terms use the European exploration and colonization of the North American Continent as a cultural benchmark for our understanding of Native American cultures. The Pre-Contact Period serves as a summary of key events and concepts prior to the European entrada; the Post-Contact Period represents cultural adaptation that continues to the present day.

CONSTRUCTION AND OPERATIONS PLAN

Site Characterization and Assessment of Impacts – Cultural Resources

Sunrise Wind Farm

There are no previously identified pre-contact archaeological sites within the SRWF; however, historic sea-level rise data show that this area would have been sub-aerial and open for human occupation during the Paleoindian Period (TRC 2012). Material evidence for use of the SRWF after marine transgression may include remnants of fishing gear, watercraft, or artifact assemblages associated with inland occupations, extraction sites, or other cultural activities on the now-submerged sections of the ancient landscape.

Historic-period MARs that may be located within the SRWF include shipwrecks and downed aircraft from the post-contact eras. The databases consulted during background research revealed at least seven charted shipwrecks and/or obstructions within 1 mi (1.6 km) of the Lease Area. The number and types of shipwrecks identified within the SRWF will be included in Appendix R following additional research and survey data review.

Sunrise Wind Export Cable–OCS

Historic sea-level rise data show that part of the proposed SRWEC–OCS was likely inundated around the same time (approximately 10,000 yBP), or possibly even earlier, than the SRWF, since the proposed route extends to the southwest of the SRWF before turning northwest toward landfall at Fire Island, NY. Therefore, the potential for pre-contact MARs may include Paleoindian Period sites within the SRWEC–OCS section furthest offshore, as well as Archaic Period (10,000 to 3,000 yBP) sites along the SRWEC–OCS further inshore.

Potential historic-period MARs within the SRWEC–OCS will mirror those found within the SRWF. One exception is the potential to encounter shipwreck sites of recreational vessels as those craft would be expected at increasingly higher densities closer to shore. The databases consulted during background research revealed two shipwrecks within 1 mi (1.6 km) of the SRWEC–OCS centerline. The number and types of shipwrecks identified within the SRWEC–OCS will be included in Appendix R following additional research and survey data review.

Sunrise Wind Export Cable–NYS

MARs that may be encountered within the SRWEC–NYS include both pre-contact sites and post-contact sites. Historic sea-level rise data indicates that this portion of the SRWEC would have been submerged approximately 4,000 yBP, so it is unlikely that any submerged, buried Woodland Period (3,000 to 400 yBP) sites will be identified nearshore (Merwin 2010).

Potential historic-period MARs within the SRWEC–NYS will mirror those found within the SRWEC–OCS and SRWF. The databases consulted during background research revealed three shipwrecks and/or obstructions within 1 mi (1.6 km) of the SRWEC–NYS centerline. The number and types of shipwrecks identified within the SRWEC–NYS will be included in Appendix R following additional research and survey data review.

CONSTRUCTION AND OPERATIONS PLAN

Site Characterization and Assessment of Impacts – Cultural Resources

4.6.1.2 Potential Impacts

Construction, O&M, and decommissioning activities associated with the SRWF, SRWEC, and Onshore Facilities have the potential to cause both direct and indirect impacts on submerged cultural resources (shipwrecks and/or paleolandforms). Communication with the NYSHPO confirmed that based on the proposed activity and on tidal scour and disturbance from previous bridge and pier construction activities, there are no additional surveys needed for the proposed temporary floating pier. IPFs associated with the construction and O&M phases of the Project are identified in Figure 4.6.1-3 and described separately, by phase, in the following sections. For the decommissioning phase of the Project, impacts are anticipated to be similar to or less adverse than those described for construction; therefore, impacts from decommissioning are not addressed separately in this section. Supporting information on impacts to MARs, such as shipwrecks and paleolandforms, is presented in further detail in Appendix R, under confidential cover.

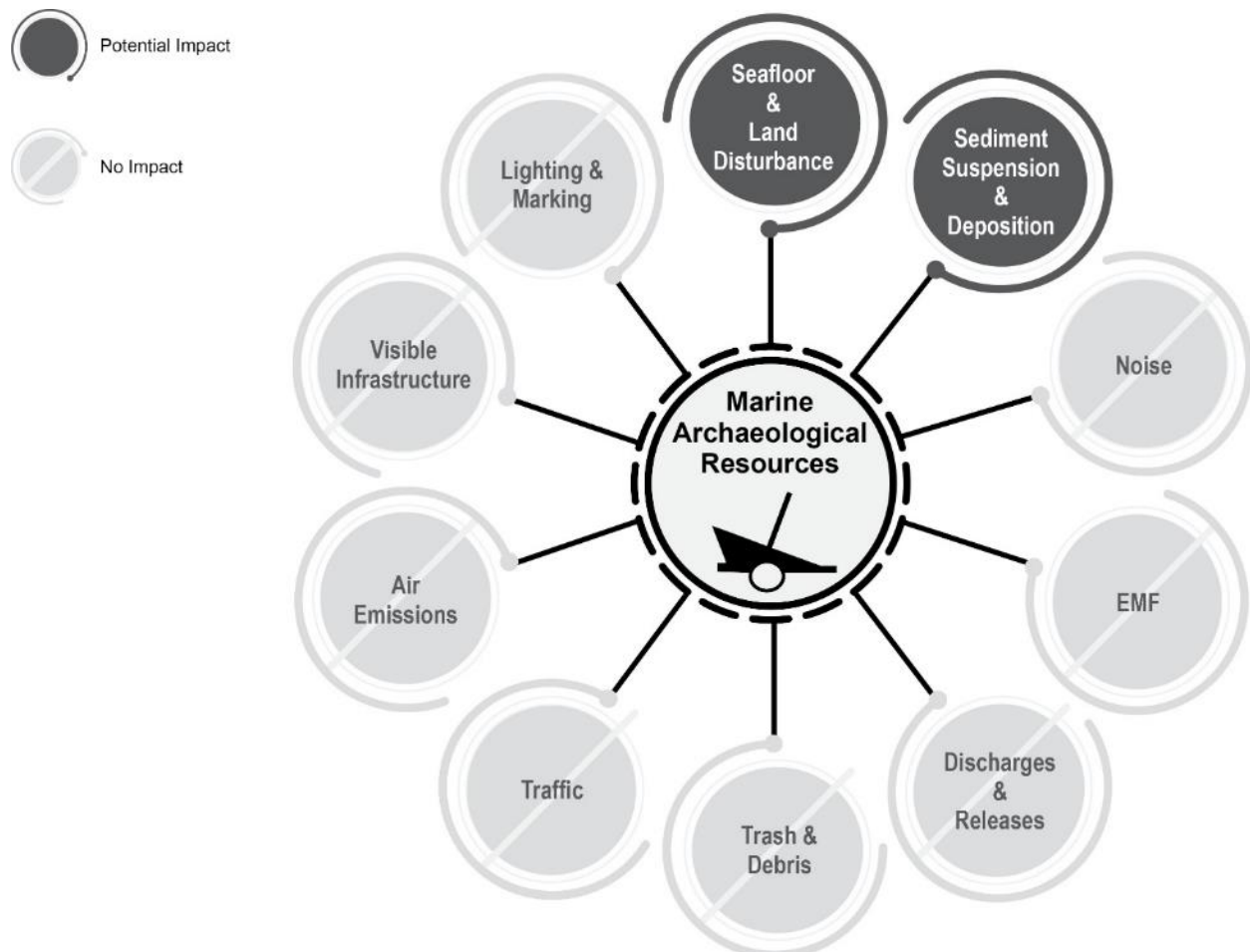

Figure 4.6.1-3 Impact-Producing Factors on Marine Archaeological Resources

CONSTRUCTION AND OPERATIONS PLAN

Site Characterization and Assessment of Impacts – Cultural Resources

Sunrise Wind Farm, Sunrise Wind Export Cable, and Onshore Facilities

Construction

Seafloor Disturbance

Installation of the WTGs, OCS–DC, IAC, and SRWEC will introduce direct bottom impacts to the seafloor within the vertical and horizontal limits of the PAPE. Previously identified shipwrecks and unidentified cultural resources (both pre-contact and post-contact) may be impacted directly by installation or indirectly by other associated bottom disturbance activities. Preparation of the seafloor for installation of foundations and cables may include sand wave leveling and the clearance of debris, boulders, and other objects. DP vessels will generally be used for cable burial activities. If anchoring (or a pull ahead anchor) is necessary during cable installation, it will occur within the survey corridor. The excavation of a subsurface trench in which to lay the cables would impact submerged resources located within or adjacent to the trench during its excavation. These activities could impact archaeological resources located within the area of seafloor preparation.

The maximum horizontal limit of disturbance for the SRWEC is 98 ft (30 m), inclusive of pre-lay grapnel runs, cable installation, boulder clearance, sand wave leveling, and secondary cable protection. The specific cable alignment has not been determined and the PAPE accounts for the maximum vertical and horizontal limits in which seabed disturbance associated with SRWEC cable construction could occur. The maximum vertical limit of disturbance includes 10 ft (3 m) from cable installation, 16 ft (5 m) for the HDD exit pits, and 15 ft (4.7 m) from potential vessel anchorage. Sunrise Wind has taken the necessary steps to site WTGs, IAC, and the SRWEC away from previously identified submerged resources, and avoidance areas surrounding identified MARs will further reduce the chances of accidental disturbance. The size of these avoidance areas will be determined individually based on characterization of the site and delineation of the site's horizontal and vertical boundaries.

The installation of the WTG and OCS–DC foundations will require deep seabed disturbance that may potentially impact submerged cultural resources located within the foundation placement areas or within those areas where the vessels installing the foundations are anchored or spudded. The maximum horizontal limit of disturbance for the WTG foundation and OCS–DC installation is a 220-m (722-ft) radius measured from the center of the monopile foundation or pile. The total area of horizontal disturbance per foundation is 37.6 ac (15.2 ha). The maximum vertical limit of disturbance includes 66 to 180 ft (20 to 55 m) associated with WTG foundation installation and approximately 66 to 295 ft (20 to 90 m) associated with OCS–DC foundation installation, as well as up to 52 ft (15.8 m) associated with jack-up vessel spudcans. This disturbance could affect both submerged historic and pre-contact MARs. The SRWF section of the PAPE encompasses all potential foundation locations associated with the Project.

Installation of the IAC system will occur within the SRWF section of the PAPE. The IAC will be buried to a target depth of approximately 2 to 7 ft (0.6 to 2 m). The marine archaeological resource assessment conservatively assumes a maximum depth of disturbance for installation of these Project components of 10 ft (3 m). The final design and alignment of the associated cables has not been determined. The PAPE accounts for the maximum vertical and horizontal limits of seabed disturbance that could occur during IAC installation.

CONSTRUCTION AND OPERATIONS PLAN

Site Characterization and Assessment of Impacts – Cultural Resources

The installation of the Onshore Transmission Cable will include a 2,660-ft (810-m) long HDD that will be below the ICW. The maximum vertical limit of disturbance will be confirmed following additional design and engineering. The maximum horizontal limit of disturbance of each HDD exit pit is 50 x 15 m (164 x 49 ft) and the maximum limit of vertical disturbance is 5 m (16 ft). The maximum horizontal limit of disturbance associated with the area of anchorage for all three HDD exit pits is 500 m² (1,640 ft²) with a maximum limit of vertical disturbance equal to 4.7 m (15 ft).

Increased vessel traffic associated with the construction of the WTGs, OCS–DC, IAC, and SRWEC may introduce direct impacts to the seafloor. Directly associated with bottom disturbance, this increase could affect MARs by creating an environment where physical damage may occur from indiscriminate anchoring practices, offloading mishaps, and dumping. This activity would primarily affect those submerged resources such as shipwrecks that are exposed on the seafloor or are partially obscured by shallow sediments. Inadvertent anchor drops, anchor drags, and jettisoned construction debris from surface vessels can damage the integrity or destroy MARs over time. Deeply buried pre-contact sites are not anticipated to be affected by activities associated with increased vessel traffic. With boating regulations, defined anchorage areas, and MARs monitoring by marine archaeologists, the damaging effects to submerged MAR sites from increased traffic would be considered minimal.

Sediment Suspension and Deposition

Construction activities associated with the SRWF and SRWEC will cause the suspension and deposition of sediments found near and adjacent to the areas of seafloor disturbance. Sediment suspension and deposition will primarily affect MARs exposed above the seafloor, such as shipwrecks. The suspension of sediment covering previously buried elements of the resource may expose those sections to further impacts such as an increased threat of corrosion. Previously buried wooden timbers may be subject to attack by shipworms (*Toredo navalis*), a form of saltwater clam, that can destroy historic intact shipwreck remains in a matter of months. The suspension and deposition of sediments is not expected to impact more deeply buried submerged cultural resources, such as pre-contact archaeological resources that may be buried several meters below the seafloor. Furthermore, avoidance areas surrounding identified MARs will limit the amount of sediment suspension and deposition near the resource; therefore, the potential for impacts from sediment suspension and deposition is low.

Operations and Maintenance

Regular O&M activities would not be expected to cause irreparable damage to MARs or involve activities that have potential to cause impacts to MARs when those activities are carried out in accordance with recommendations of the Project's marine archaeologists. Inadvertent damage to submerged cultural resources caused from seafloor disturbance, increased traffic, and sediment suspension and redeposition will be reported to all appropriate agencies and managed by the Project's Qualified Marine Archaeologist. However, if damage occurs because of this activity, there may be localized impacts to MARs from O&M activities.

CONSTRUCTION AND OPERATIONS PLAN

Site Characterization and Assessment of Impacts – Cultural Resources

Seafloor Disturbance

Activities occurring during the O&M phase may also affect MARs. Impacts associated with seafloor disturbance that can be reasonably anticipated to arise during O&M are those associated with anchoring or spudding of vessels conducting routine or nonroutine maintenance. Non-routine maintenance might also include the uncovering or reburial of the SRWEC in the event of a fault or failure. This process would likely disturb the seafloor and have the potential to impact nearby resources. The MARs potentially impacted by the O&M phase of the Project would be limited to those resources also potentially impacted during the construction phase unless bottom disturbance (due to needed repairs) is required outside of previously disturbed areas or within previously established avoidance areas.

Increased vessel traffic associated with the O&M of the WTGs, OCS-DC, IAC, and SRWEC will also introduce direct bottom impacts to the seafloor. Directly associated with bottom disturbance, this increase may affect submerged cultural resources by creating an environment where physical damage may occur from indiscriminate anchoring practices, offloading mishaps, and inadvertent dumping; particularly by boat crews who are unfamiliar with the protective avoidance buffers initially established to protect previously identified MARs in the area. This activity would primarily affect those submerged resources such as shipwrecks that are exposed on the seafloor or are partially obscured by shallow sediments. Inadvertent anchor drops, anchor drags, and jettisoned debris from surface vessels can damage the integrity or destroy a submerged archaeological site over time. Deeply buried pre-contact archaeological resources are not anticipated to be affected by activities associated with increased vessel traffic. With boating regulations, defined anchorage areas, and MARs monitoring by marine archaeologists, the damaging effects to submerged MARs from increased traffic would be considered minimal.

Sediment Suspension and Deposition

Impacts to MARs from sediment suspension and deposition during O&M may occur, although impacts are less likely than during construction. The suspension of sediments wholly or partially covering a submerged cultural resource may expose that resource to damage from environmental factors to which it may not have been previously subjected. For example, components or sections of an historic shipwreck that are newly exposed to an aerobic environment may be impacted through corrosion or by organisms not found in anaerobic environments (shipworms). Nevertheless, the avoidance buffer surrounding identified resources would significantly limit those potential impacts.

4.6.1.3 Proposed Environmental Protection Measures

Sunrise Wind continues to evaluate prudent and feasible design options that would avoid, minimize, or mitigate impacts to significant submerged cultural resources. A detailed mitigation plan addressing anticipated impacts to historic properties, inclusive of MARs, will be developed. The mitigation plan will incorporate the results of the Marine Archaeological Resources Assessment (Appendix R) and present property-specific measures for all MARs subject to potentially unavoidable adverse effects (per 36 CFR 800.5). To the extent feasible and appropriate, MARs-related measures presented in the plan will incorporate the views of Native American tribes/nations for whom submerged resources may have traditional cultural

CONSTRUCTION AND OPERATIONS PLAN

Site Characterization and Assessment of Impacts – Cultural Resources

significance. Sunrise Wind will continue to consult with BOEM, and engage with Native American tribes/nations, affected SHPOs, and other interested parties, to refine and adapt the proposed mitigation measures and incorporate information gathered from other recent offshore projects. Sunrise Wind will implement the following environmental protection measures to reduce potential impacts on MARs. These measures are based on protocols and procedures successfully implemented for similar offshore projects.

- The SRWF and SRWEC will be sited to avoid or minimize impacts to potential MARs, including shipwrecks and paleolandforms, to the extent practicable, with continued oversight by a Qualified Marine Archaeologist.
- Native American tribes were involved, and will continue to be involved, in marine survey protocol design, execution of the surveys, and interpretation of the results.
- A plan for vessels will be developed prior to construction to identify no-anchorage areas to avoid documented sensitive resources.
- Avoidance areas surrounding identified MARs will reduce the chances of accidental disturbance. The size of these areas will be determined individually based on characterization of the site and delineation of the site's horizontal and vertical boundaries.
- An Unanticipated Discovery Plan will be implemented that will include stop-work and notification procedures to be followed if potentially significant MARs are encountered or inadvertently disturbed during construction.

4.6.2 Terrestrial Archaeological Resources

This section describes the affected environment and potential effects resulting from the construction and operation of the Onshore Facilities portion of the Project as they relate to terrestrial archaeological resources. Additional information to support this section can be found in Appendix S1 and S2. The Phase IA report outlines the research design, soils, physical topography, historic context, and the fieldwork methodology employed during the archaeological field survey. The Phase IA report also provides detailed information on the archaeological testing locations (Figure 1.2-1 in Appendix S1 and Figure 1.2-1 in Appendix S1 Addendum). The Phase 1B report provides results of the archaeological field survey, in which testing locations (Figure 1.2-1 in Appendix S2) were investigated to determine if archaeological resources will be impacted during construction of the Onshore Facilities. The archaeological field survey included previously undisturbed testing locations along the Onshore Facilities depicted in Figure 1.1-2 of the COP. This section applies only to terrestrial archaeological resources. Information and impacts related to above-ground historic properties is contained in Section 4.6.3.

The description of the affected environment and assessment of potential impacts were developed by reviewing currently available data sources related to terrestrial archaeological resources including state and federal agency-published papers and databases, online data portals and mapping databases (e.g., the NYSHPO's Cultural Resource Information Service [CRIS] database), environmental studies, published scientific literature relating to relevant prior cultural resources studies in the vicinity of the Onshore Facilities, and correspondence and consultation with federal and state agencies.

CONSTRUCTION AND OPERATIONS PLAN

Site Characterization and Assessment of Impacts – Cultural Resources

Specific requirements for the submittal of terrestrial archaeological resources information within this COP are provided in BOEM's *Guidelines for Providing Archaeological and Historic Property Information Pursuant to 30 CFR Part 585*. Archaeological investigations of the Onshore Facilities were conducted in accordance with the New York Archaeological Council's (NYAC) *Standards for Cultural Resources Investigations and the Curation of Archaeological Collections in New York State* (the NYAC Standards) and the New York SHPO Guidelines, entitled *Phase I Archaeological Report Format Requirements*, as appropriate. The archaeological investigation was overseen by a Registered Professional Archaeologist (RPA) who meets the US Secretary of Interior's Standards for Archaeology (per 36 CFR 61). In addition, the information gathered in the archaeological survey will be used to fulfill Project requirements under Section 106 of the NHPA. BOEM will consult with Native American tribes and other parties to determine an appropriate approach for the identification and protection of cultural resources that may be present within the PAPE.

The NYAC Standards and NYSHPO Guidelines establish a phased approach to identification and evaluation of archaeological resources. This typically begins with a desktop review of information maintained by the NYSHPO in CRIS, professional literature, historical cartography, and online resources. The CRIS database includes NRHP-eligible and -listed properties and sites, historic districts, previously recorded archaeological sites, cemeteries, and areas subject to previous archaeological investigations. The desktop review is followed by field testing for the presence of archaeological deposits in the PAPE. If intact archaeological deposits are found, and avoidance is not feasible, further investigations may be required to determine eligibility for the NRHP.

The terrestrial archaeological investigation focuses on the PAPE for direct impacts. The PAPE is defined as the area containing all proposed soil disturbance or other alteration associated with the SWREC Landfall Work Area and the Onshore Facilities. The formal determination of the APE—per 36 CFR 800.4(a)(1)—will occur once BOEM accepts the COP, consistent with 30 CFR 585 et seq.

For the purposes of this assessment, a PAPE was determined based on the maximum spatial limits of ground disturbance associated with the SWREC Landfall Work Area at Smith Point County Park (TJBs and link boxes) and Onshore Facilities (Onshore Transmission Cable, OnCS–DC, and Onshore Interconnection Cable) (Figure 4.6.2-1). Additional detail for the Onshore Facilities is provided in Section 3. The SRWF and SRWEC are not considered part of the PAPE for terrestrial archaeological resources given their location in the marine environment. MARs are addressed in Section 4.6.1.

\edfcsy-r607\jobs\19195_Sunrise_Wind\Graphics\Figures\COP\MXD\19195_COP_Figure_4.6.2-1_Sunrise_Wind_Farm_Project_Terrestrial_Archaeology_PAPE.mxd
 Revised: 2021-08-25 By: dbarney

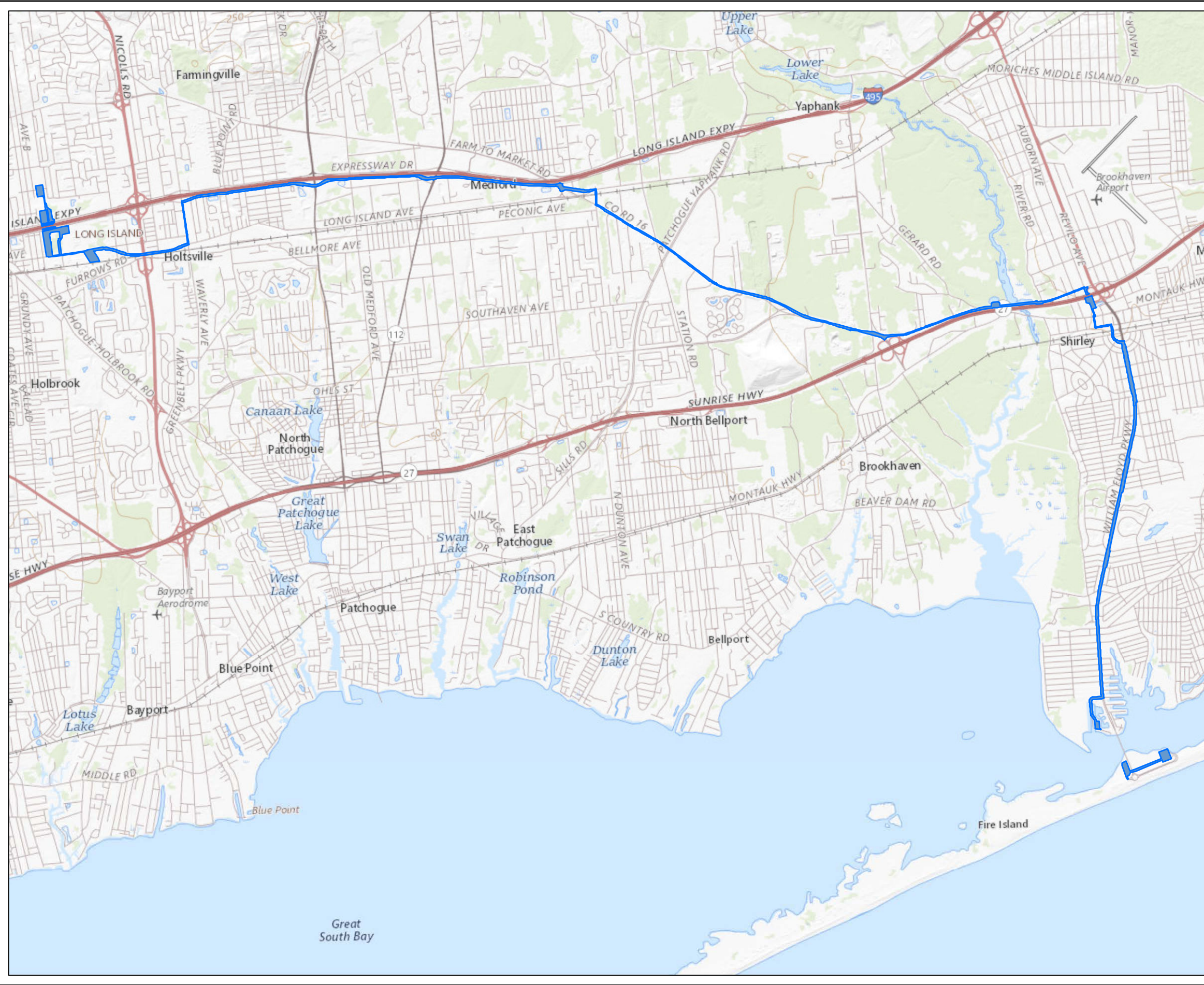

Figure 4.6.2-1
Sunrise Wind Farm Project
Terrestrial Archaeology PAPE
Sunrise Wind | Powered by Ørsted & Eversource

Legend

- Terrestrial Archaeology Preliminary Area of Potential Effect (PAPE)

Sources
 Base map: USGS The National Map

Date	8/23/2021
Project Number	2028113199
Prepared By	DLB
Reviewed By	JK

0 1 mile
 0 1.5 km

Scale of 1:117: 1:63,360
 NAD 1983 2011 UTM Zone 18N

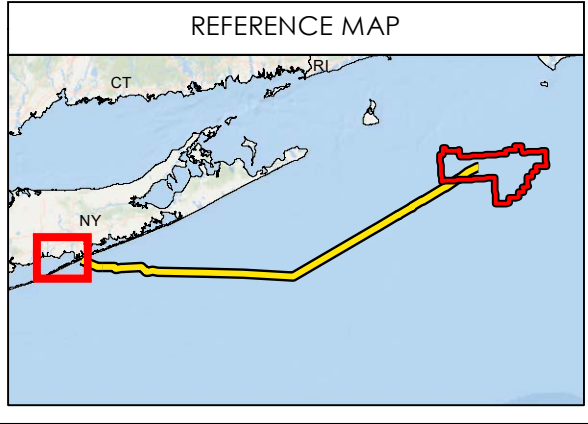

This page intentionally left blank

CONSTRUCTION AND OPERATIONS PLAN

Site Characterization and Assessment of Impacts – Cultural Resources

4.6.2.1 Affected Environment

Onshore Facilities

Based on archival research, potential archaeological resources within the PAPE might include both pre-contact Native American and historic-period sites. Pre-contact Native American resources are those older than 1500 AD, often consisting of lithic debris (stone flakes) and/or tools and projectile points, ceramics, and possible shell or bone food refuse. Historic-period archaeological resources may include glazed ceramics, glass, metal tools and hardware, and manufactured personal and decorative artifacts. The presence of modern materials is also expected, such as plastic fragments, modern bottle glass, synthetics, and twentieth-century architectural materials.

A review of CRIS to identify previously reported cultural resources that might be directly affected by the Project shows that two recorded pre-contact archaeological sites are within the PAPE. Little information is known or recorded about these sites in the NYSHPO database. They are depicted in CRIS as areas of elevated archaeological sensitivity and should not be considered equivalent to formally tested and delineated archaeological sites. Additional information on these sites can be found in Appendix S1, Table 2.

In addition, there is one historic-period sites located immediately adjacent to the PAPE. This historic-period site, the Carmans Mill and Homestead Site (USN 10302.001130) is located immediately adjacent to the PAPE. The mill dates from early to mid-eighteenth century and was destroyed in 1958 for construction of the Sunrise Highway while the house was privately removed in 1936. The site formerly encompassed a relatively small area adjacent to the PAPE, but has since been destroyed by construction of Sunrise Highway.

These previously documented archaeological sites are described in greater detail in Appendix S1.

Sunrise Wind consulted the CRIS database and professional literature to determine if previous archaeological surveys had been conducted within, or within 0.25 mi (0.40 km) of, the PAPE. In total, five cultural resource surveys overlap with portions of the PAPE. According to the CRIS database, three previous surveys overlap with portions of the PAPE and consist of one Phase IA survey in support of municipal sewer improvements (Louis Berger Group 2016), one Phase IB survey in support of municipal sewer improvements (Chrysalis Archaeological Consultants 2018), and one combined Phase IA/IB archaeological and architectural survey in support of road improvements (NYSM 2010). In addition, two archaeological management plans were conducted for the Fire Island National Seashore (Gray & Pape [GP] 2005; William and Mary Center for Archaeological Research 2016). Additional detail on these surveys can be found in Table 1, and Figure 2 in Appendix S1.

Only one of the surveys noted above (NYSM 2010) conducted archaeological testing (i.e., shovel testing, pedestrian surface survey, etc.) anywhere within the PAPE. A review of the technical report completed for the survey indicates that shovel testing conducted for that project overlaps portions of the PAPE along the south side of Victory Avenue. No archaeological resources were identified within the PAPE, but shovel testing identified the Southaven Circle Site (USN 10302.002928), which is outside the PAPE.

CONSTRUCTION AND OPERATIONS PLAN

Site Characterization and Assessment of Impacts – Cultural Resources

Ten previous archaeological surveys/investigations have been conducted outside the PAPE but within a 0.25-mi (0.40-km) buffer. One other previous archaeological survey overlaps with the Landfall Study Area but is not within the PAPE or the 0.25-mi (0.40-km) buffer (Panamerican Consultants, Inc. 1999, 2003). All these surveys outside the PAPE are described in greater detail in Table 1 and Figure 2 in Appendix S1.

With respect to the potential for archaeological remains in the PAPE, Sunrise Wind developed a sensitivity model in Appendix S1. Due to the presence of several previously identified pre-contact archaeological sites within and/or near the PAPE, as well as the proximity to the coast and freshwater streams, the intact landforms of the PAPE should be considered sensitive for the presence of pre-contact Native American archaeological resources, particularly across the eastern portion of the PAPE (see Figure 3, Appendix S1).

Much of the PAPE is characterized by post-contact Native American or Euro-American domestic sites, reflecting a mixture of small households and large farms dating from the eighteenth and nineteenth centuries. This was followed by dense mid-to late-twentieth century residential development. With respect to historic-period archaeological sensitivity, as mentioned above, there are seven previously recorded archaeological sites with historic-period components located within 0.25 mi (0.40 km) of the PAPE. These sites, all of which are associated with former buildings (i.e., houses, tavern/store, mill, and church), consist of architectural and/or domestic artifact scatters, primarily dating to the eighteenth and/or nineteenth centuries. As illustrated by these sites, when determining the probability of encountering historic-period archaeological resources, increased potential exists at the locations of former structures. As such, a review of historical maps for identifying map-documented structures (MDS) is the most effective way for determining historic-period archaeological sensitivity. As part of the background research for the Project, Sunrise Wind collected data from multiple historical cartographic sources, described in greater detail in the Phase IA archaeological survey report (Appendix S1).

Due to the presence of previously identified historic-period archaeological sites near the PAPE and the significant amount of MDS locations along the route of the Project's proposed Onshore Transmission Cable and Onshore Interconnect Cable, the intact landforms of the PAPE should be considered sensitive for the presence of historic-period archaeological resources, particularly in the vicinity of communities that have existed prior to suburbanization.

4.6.2.2 Potential Impacts

Construction, O&M activities, and decommissioning associated with the Onshore Facilities have the potential to cause direct impacts on terrestrial archaeological resources. No direct impacts are expected from the Landfall or ICW Work Areas. The SRWF and SRWEC will not create IPFs on terrestrial archaeological resources, as they are not considered part of the PAPE for terrestrial archaeological resources given their location in the marine environment. IPFs associated with the construction and O&M phases of the Project are identified on Figure 4.6.2-2 and described separately, by phase, for the Onshore Facilities in the following sections. For the decommissioning phase of the Project, impacts are anticipated to be similar to or less adverse than those described for construction; therefore, impacts from decommissioning are not addressed separately in this section. Supporting information on impacts to terrestrial archaeological resources are also presented in further detail in Appendix S1 and Appendix S2.

CONSTRUCTION AND OPERATIONS PLAN

Site Characterization and Assessment of Impacts – Cultural Resources

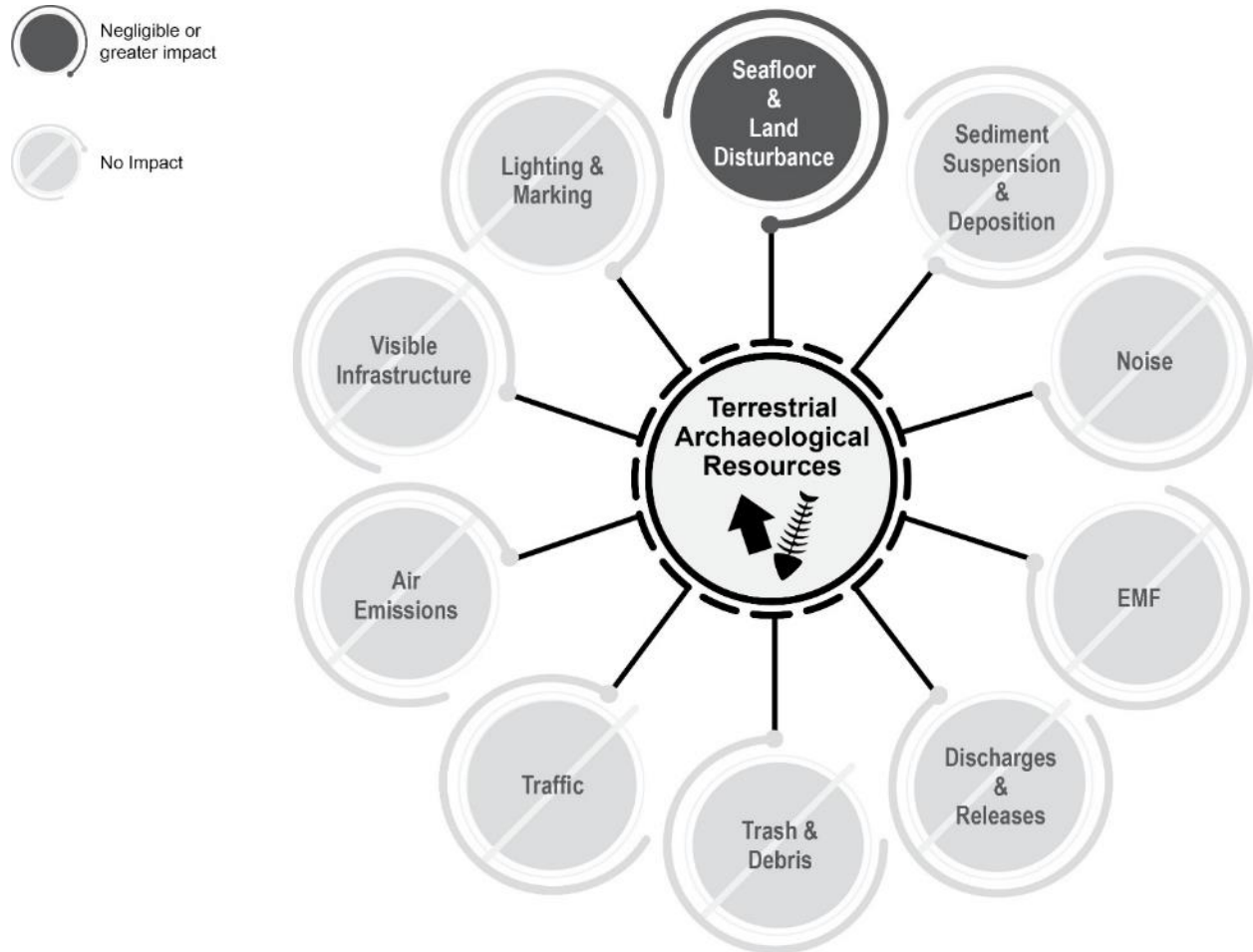

Figure 4.6.2-2 Impact-Producing Factors on Terrestrial Archaeological Resources

Onshore Facilities

As noted above, no IPFs are anticipated for either the SRWF or the SRWEC with respect to terrestrial archaeological resources. For the Onshore Facilities, the only significant IPF is Land Disturbance. As described above, this will result from site clearance, grading, excavation, and filling during the construction phase of the SWREC Landfall Work Area, Onshore Transmission Cable, the OnCS–DC, and Onshore Interconnection Cable. It is not expected that normal O&M for the Onshore Facilities will result in potential adverse impacts to terrestrial archaeological resources.

CONSTRUCTION AND OPERATIONS PLAN

Site Characterization and Assessment of Impacts – Cultural Resources

Construction

Land Disturbance

The Onshore Transmission Cable will extend from the TJB at Smith Point County Park on Fire Island to the proposed OnCS–DC at the Union Avenue Site, where the Onshore Interconnection Cable will extend to the existing Holbrook Substation, all of which will be sited within the Town of Brookhaven, NY. It is anticipated that the vertical limits of disturbance for construction of the Onshore Facilities will range from approximately 3 ft (0.9 m) to 15 ft (4.6 m) in depth based on the respective component, based on site selection and final design.

Although the approximate maximum depth of disturbance extends to 15 ft (4.6 m), no archaeological resources are anticipated to extend more than approximately 1 meter below the ground surface. The Onshore Facilities will be located within outwash plain sediments, which were deposited by glacial meltwater at the end of the Wisconsin Glaciation. As such, the Onshore Facilities predominately do not occur within a geomorphic setting that has undergone sediment deposition, that may have deeply buried archaeological resources, since the retreat of the Laurentide Ice Sheet.

The Carmans River vicinity represents the only area with the potential to contain deeply buried archaeological resources within the Onshore Facilities. However, Phase 1B archaeological survey (shovel testing) has already been conducted adjacent to the river and it is not anticipated that deeply buried (more than 1 meter) archaeological resources occur in this area. Culturally-sterile subsoil, glacial fill, and/or stream channel lag deposits were encountered in shovel tests adjacent to the river, indicating that any archaeological resources in this area would be less than 1 meter in depth.

The only Onshore Facilities that will not be sited within outwash plain sediments are located in Smith Point County Park on Fire Island; however, these areas have already been determined to be disturbed (no archaeological potential) via field reconnaissance and/or desktop assessment, as discussed in the Phase 1A archaeological survey report. It is not anticipated that deep testing would reveal additional deeply buried archaeological resources.

The majority of the Onshore Facilities have been sited within previously disturbed areas and will therefore avoid archaeological sites and/or historic properties to the extent feasible. Phase 1B archaeological surveys conducted to date for the proposed Onshore Facilities (Figure 1.1-2) did not document any archaeological discoveries (Appendix S2). Field investigations of some archaeologically sensitive areas are not feasible at this time because temporary laydown areas are not fully identified. Sunrise Wind anticipates that identification efforts at such locations would be conducted under BOEM's deferred identification process. Additionally, the results of the previous terrestrial archaeological studies, as well as agency and tribal input, are being considered during development of the proposed Project. As a result, the Project design is anticipated to avoid direct impacts to reported archaeological resources. Although every effort will be made to site the Onshore Facilities away from known archaeological resources, unanticipated discoveries during construction remain a possibility. Therefore, construction of the Onshore Facilities maintains the potential to result in direct impacts to terrestrial archaeological resources. Sunrise Wind will prepare an Unanticipated Discovery Plan in accordance with state and federal laws.

CONSTRUCTION AND OPERATIONS PLAN

Site Characterization and Assessment of Impacts – Cultural Resources

The plan will provide specific contacts and reporting protocol if archaeological materials or human remains are discovered during construction.

Operations and Maintenance

Land Disturbance

Disturbance to terrestrial archaeological resources during the O&M phase would occur only during instances where there is a system failure that requires re-excavation of any portion of the Onshore Transmission Cable or Onshore Interconnection Cable. The impact would be similar to or less than what was described for the construction phase, above. In addition, any O&M disturbance would generally be limited to locations previously disturbed during installation of the Project facilities; therefore, no impact during O&M is anticipated.

4.6.2.3 Proposed Environmental Protection Measures

Sunrise Wind has not identified potentially significant (NRHP-eligible) terrestrial archaeological resources within the onshore PAPE. Should such resources be identified during archaeological survey of currently inaccessible sections of the PAPE, Sunrise Wind will evaluate feasible and prudent design options to avoid or minimize impacts to such resources. If unavoidable impacts to significant archaeological resources are identified, Sunrise Wind will develop appropriate mitigation measures. A detailed mitigation plan addressing anticipated impacts to historic properties, inclusive of terrestrial archaeological sites, will be developed. The mitigation plan will incorporate the results of the terrestrial archaeological assessments (Appendices S1 and S2) and present property-specific measures for all sites subject to potentially unavoidable adverse effects (per 36 CFR 800.5). To the extent feasible and appropriate, MARS-mitigation measures presented in the plan will incorporate the views of Native American tribes/nations for whom terrestrial archaeological resources may have traditional cultural significance. Sunrise Wind will continue to consult with BOEM, and engage with Native American tribes/nations, affected SHPOs, and other interested parties, to refine and adapt the proposed mitigation measures and incorporate information gathered from other recent offshore projects. Sunrise Wind has and will implement the following environmental protection measures to reduce potential impacts on terrestrial archaeological resources. These measures are based on protocols and procedures successfully implemented for similar offshore projects and their respective onshore facilities.

- Onshore Facilities are primarily sited within previously disturbed and developed areas (e.g., roadways, ROWs, developed industrial/commercial areas) to the extent feasible, to minimize impacts to potential archaeological resources.
- Onshore Facilities have been sited, using guidance from cultural resources surveys, to avoid or minimize impacts to potential terrestrial archeological resources.
- Native American tribes were involved, and will continue to be involved, in terrestrial survey protocol design, execution of the surveys, and interpretation of the results.
- An Unanticipated Discovery Plan will be implemented that will include stop-work and notification procedures to be followed if a cultural resource is encountered during installation.

CONSTRUCTION AND OPERATIONS PLAN

Site Characterization and Assessment of Impacts – Cultural Resources

4.6.3 Above-Ground Historic Properties

This section describes the affected environment and potential effects from the construction and operation of the Project as they relate to above-ground historic properties. The description of the affected environment and assessment of potential impacts were developed by reviewing current public data sources related to above-ground historic properties, including state and federal agency-published papers and databases (e.g., studies conducted by BOEM in 2012 to prepare a GIS database of known cultural resources/historic properties that could be affected by the introduction of offshore energy facilities along the east coast of the US); online data portals and mapping databases (e.g., the NYSHPO CRIS website, Massachusetts Historical Commission [MHC] online Massachusetts Cultural Resource Information System [MACRIS], Rhode Island Historical Preservation & Heritage Commission [RIHPHC], Rhode Island Historical Cemetery Commission [RIHCC]); environmental studies (e.g., previously completed historic resources visual effects assessments [HRVEAs] for the Revolution Wind Farm and the South Fork Wind Farm); published scientific literature relating to relevant evaluations of visual effects to above-ground historic properties; and correspondence and consultation with federal and state agencies, including guidance provided by BOEM and other involved agencies and Native American tribes.

Specific requirements for submittal of an analysis of potential impacts to above-ground historic properties within this COP are provided in *Guidelines for Providing Archaeological and Historic Property Information pursuant to 30 CFR Part 585, Section 106 and Section 110 of the NHPA*, and the NEPA. In addition, the SRWEC–NYS, Onshore Transmission Cable, OnCS–DC, and Onshore Interconnection Cable are subject to review under the New York State Public Service Law (Article VII) and Section 14.09 of the *New York State Historic Preservation Act of 1980*. These sources provide regulations and guidance associated with the siting of major electric transmission facilities and the associated procedures for assessing potential impacts to above-ground historic properties. A description of the above-ground historic properties within the Preliminary Area of Potential Effect (PAPes) for the SRWF (Figure 4.6.3-1) and OnCS–DC (Figure 4.6.3-2) is provided herein, followed by an evaluation of potential Project-related impacts. The PAPes represent areas of potential visibility within larger visual study areas (VSAs), defined as a 40-mi (64-km) radius around the SRWF (which is the same as the SRWF VSA defined in Section 4.5.1), and a 1-mi (2-km) radius for the OnCS–DC (OnCS–DC HRSA, defined below), respectively. More detailed information concerning the methodology and results for all above-ground historic properties analyses conducted for the Project are presented in Appendix T – *Historic Resources Visual Effects Assessment*, and Appendix U – *Onshore Above-Ground Historic Properties Report*, the latter of which is provided under confidential cover.

J:\19195_Sunrise Wind\Graphics\Figures\COPM\2021-08-18_19195_COP_Figure 4.6.3-1_Revised Sunrise Wind Farm Visual Study Area.mxd Revised: 2021-08-18 By: arohlee

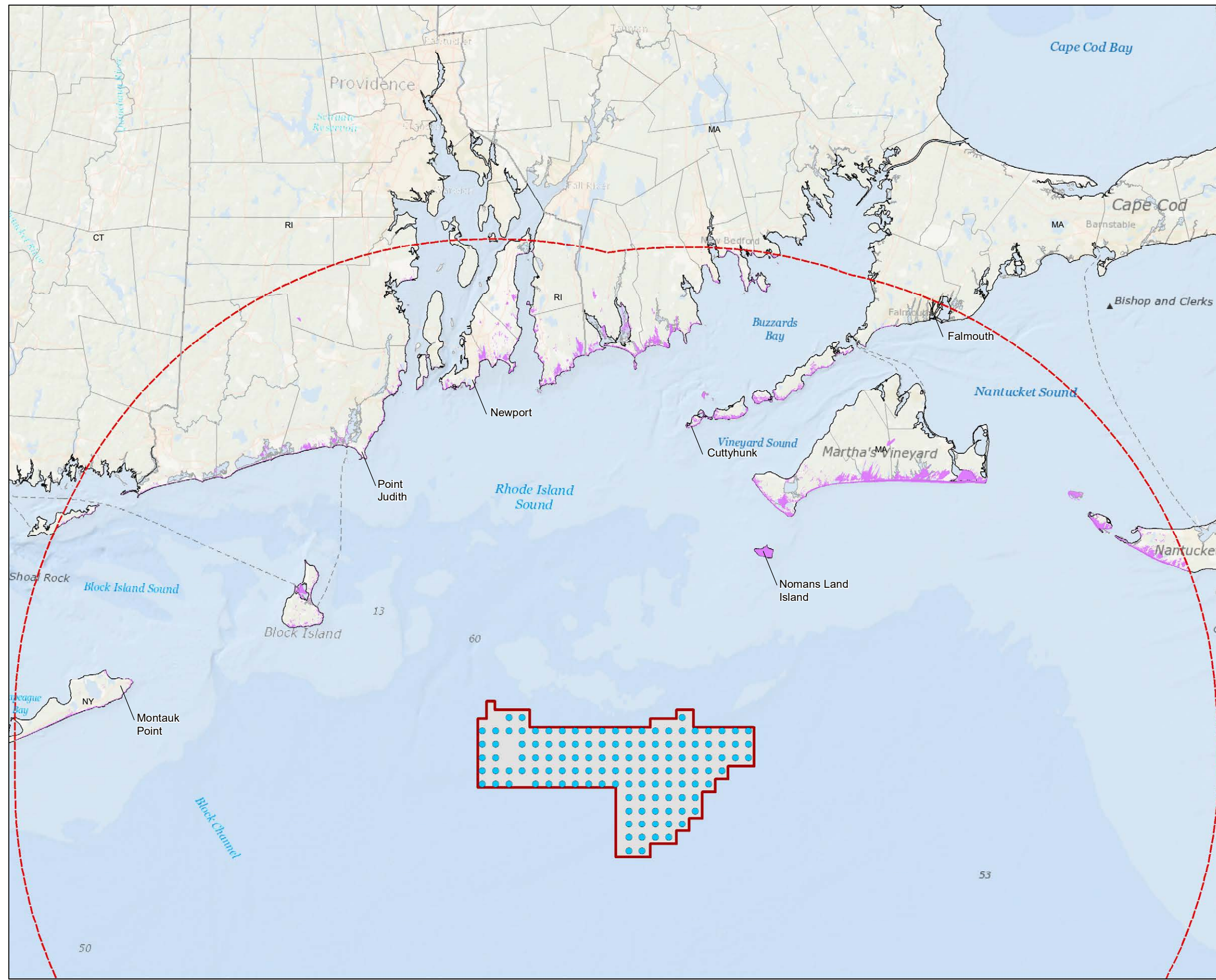

Figure 4.6.3-1
Sunrise Wind Farm
Preliminary Area of Potential Effect

Sunrise Wind | Powered by Ørsted & Eversource

- Legend**
- Indicative Turbine Layout (WTG)
 - Sunrise Wind Farm Preliminary Area of Potential Effect (PAPE)
 - Project Envelope
 - Sunrise Wind Farm Visual Study Area (SRWF VSA)



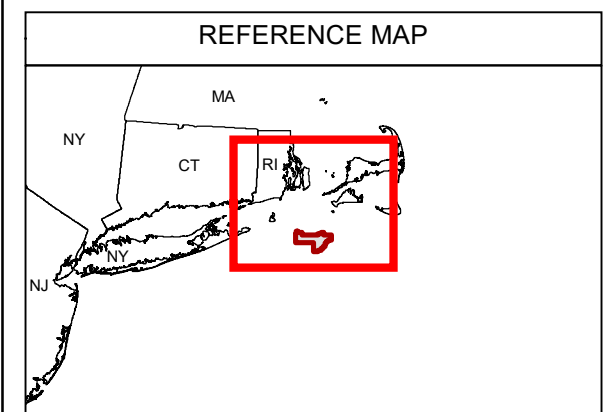
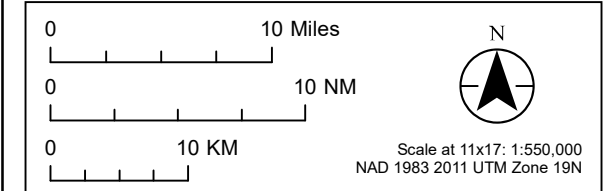

Sources
Notes: 1. Basemap: ESRI ArcGIS Online "World Ocean Base" map service. 2. This map was generated in ArcMap on August 18, 2021. 3. This is a color graphic. Reproduction in grayscale may misrepresent the data.

Date	06/01/2021 Revised: 8/23/2021
Project Number	2028113199
Prepared By	ARR
Reviewed By	GWP



This page intentionally left blank

**Figure 4.6.3-2
OnCS-DC
Preliminary Area of Potential Effect
Powered by
Sunrise
Wind
Ørsted &
Eversource**

- Legend**
-  Union Avenue Site
 -  OnCS-DC Historic Resources Study Area
 -  Onshore Converter Station (OnCS-DC)
 -  Preliminary Area of Potential Effect (PAPE)

Sources
Notes: 1. Basemap: "USGS Topo Base Map" displayed via the USGS Topo Map Service. 2. This map was generated in ArcMap on August 18, 2021. 3. This is a color graphic. Reproduction in grayscale may misrepresent the data.

Date	06/01/2021 Revised: 8/23/2021
Project Number	2028113199
Prepared By	ARR
Reviewed By	G SJ

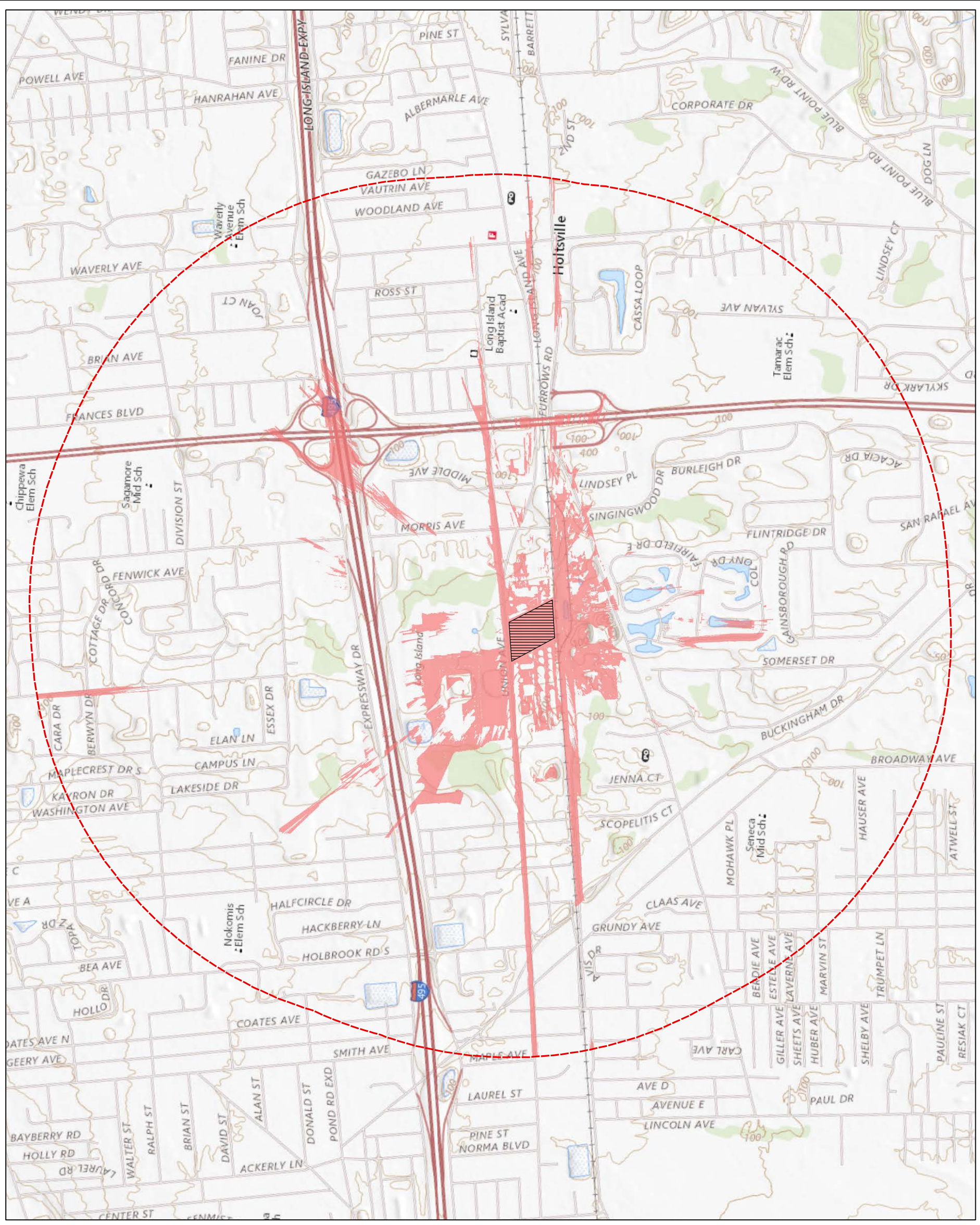
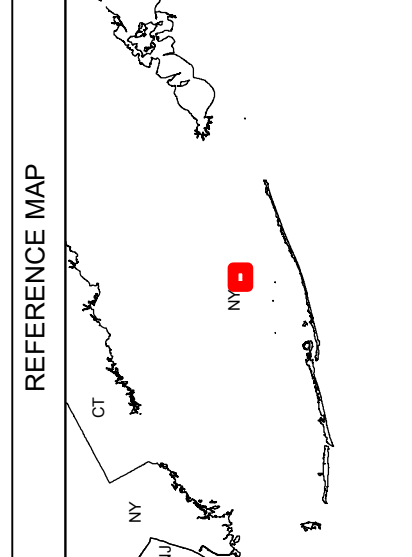
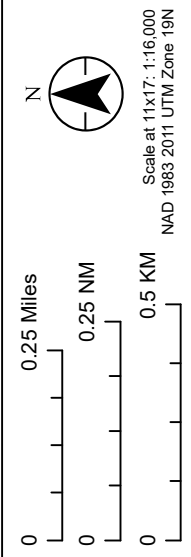

This page intentionally left blank

CONSTRUCTION AND OPERATIONS PLAN

Site Characterization and Assessment of Impacts – Cultural Resources

Above-ground historic properties are defined as districts, buildings, structures, objects, or sites that are listed or determined eligible for listing in the State and/or National Register of Historic Places (S/NRHP) or which have been designated as National Historic Landmarks (NHL). The identification of these resources and the evaluation of potential impacts involved the completion of desktop and field studies, which are detailed in Appendix T and Appendix U. Summaries of the findings of this study are presented in this section.

The evaluation of above-ground historic properties was coordinated with visual assessments prepared for the Project (Appendices Q1 and Q2). The visual assessments are dependent on, and contribute to, the anticipated review of the SRWF and SRWEC's impact on above-ground historic properties, which is required as part of BOEM's review under Section 106 and Section 110(f) of the NHPA and the Advisory Council on Historic Preservation's *Special Requirements for Protecting National Historic Landmarks* (36 CFR 800.10).

4.6.3.1 Affected Environment

The analysis herein considers above-ground historic properties within 40 mi (64 km) of the SRWF (the SRWF VSA), and within 1 mi (2 km) of the Onshore Facilities (OnCS–DC HRSA) that are located within the PAPE. Section 4.5.1 describes the methodology used to delineate the SRWF VSA, and OnCS–DC HRSA as well as the PAPE (equivalent to the Zone of Visual Influence [ZVI] as described in Section 4.5.1) associated with potential visual effects to above-ground historic properties. The VSA for the SRWF includes approximately 6,854 mi² (17,751 km²) open ocean, 685 mi² (1,774 km²) of land (including inland water bodies), and approximately 615 linear mi (990 linear km) of shoreline in New York, Connecticut, Massachusetts, and Rhode Island. Only a portion of the areas within the SRWF VSA and OnCS–DC HRSA will have open views of the SRWF and Onshore Facilities. Previously recorded and designated above-ground historic properties within the SRWF and OnCS–DC PAPEs, as well as properties that may be eligible for NRHP listing or state-level historic designation, have been identified and are listed in Table 3.1-2 of Appendix T, described in Appendix U, and summarized in the subsections that follow.

In all, 336 above-ground historic properties are located within the SRWF PAPE. For the purposes of the HRVEA, local or state designated properties are considered potentially S/NRHP-eligible pending consultation with BOEM, NYSHPO, MHC, and RIHPHC under Section 106 of the NHPA.

A total of one above-ground historic property is located within the OnCS–DC PAPE; this property has not been formally evaluated for S/NRHP eligibility, but is considered potentially S/NRHP-eligible pending consultation with BOEM and NYSHPO under Section 106 of the NHPA. No properties listed in the S/NRHP or NHLs were identified within the OnCS–DC PAPE.

The final Area of Potential Effects (APE) for above-ground historic properties will be formally determined by BOEM as part of the agency's Section 106 process; this section refers to the PAPE, equivalent to the ZVI as described in the VIA (Appendix Q1) and in Section 4.5.1, to identify areas expected to be subject to direct or indirect impacts from Project activities. The process for identifying and evaluating visual effects to historic properties resulting from the construction and operation of the SRWF, SRWEC, and Onshore Facilities will involve consultation with BOEM, SHPOs, Tribal Historic Preservation Officers (THPOs), and other consulting parties with a demonstrated interest in the historic properties (e.g., a local historical society).

CONSTRUCTION AND OPERATIONS PLAN

Site Characterization and Assessment of Impacts – Cultural Resources

Sunrise Wind Farm

Visual Study Area and Zone of Visual Influence

Currently, a standard study area for evaluating potential impacts to above-ground historic properties resulting from offshore wind farms has not been expressly defined in regulatory guidance documents. However, *Guidelines for Providing Archaeological and Historical Property Information Pursuant to 30 CFR Part 585* (BOEM 2020a) indicates that visual impacts, including potential impacts to above-ground historic properties, should be evaluated using photo simulations from locations within “the viewshed from which renewable energy structures, whether located offshore or onshore, would be visible.”

The VSA and PAPE for the SRWF are identical to the VSA and ZVI considered in Appendix Q1. A complete discussion of the 40-mi (64-km) VSA and ZVI/PAPE for the SRWF is included in Section 4.5.1.

Above-Ground Historic Properties

The identification of above-ground properties within the SRWF PAPE is an important step in determining properties which may be potentially impacted due to changes in their historic setting. These resources have generally been identified by national, state, or local governments, organizations, and/or Native American tribes as important sites which are afforded some level of historic designation or protection. In order to provide a thorough analysis, all inventoried properties in the New York, Massachusetts, Rhode Island state-level historic property databases or other publicly available sources located within the PAPE are also considered potentially eligible for listing in the NRHP. Avoiding or minimizing impacts to these resources is an important consideration in the planning stages of a project. For the HRVEA (Appendix T), a comprehensive inventory of previously identified above-ground historic properties was prepared for the entire 40-mi (64-km) radius visual study area. The HRVEA does not include the identification of new or previously unidentified above-ground historic properties that are potentially eligible for listing in the NRHP. A GIS analysis was then conducted to determine how many of these resources are within the SRWF PAPE and would require further evaluation for potential impacts. As a result of this methodology, a total of 336 above-ground historic properties are in the SRWF PAPE. A comprehensive list of resources within the PAPE is included in Appendix T.

Sunrise Wind Export Cable–OCS

Construction of the SRWEC–OCS will occur approximately 3.5 mi (6 km) from shore and installation activities will be temporary and mobile in nature. It is therefore not anticipated that the construction of the SRWEC–OCS will result in impacts to above-ground historic properties. The SRWEC–OCS will consist of a cable buried beneath the seafloor and, therefore, will also not result in operational impacts to above-ground historic properties. As such, the existing environment for above-ground historic properties is not defined for this component.

CONSTRUCTION AND OPERATIONS PLAN

Site Characterization and Assessment of Impacts – Cultural Resources

Sunrise Wind Export Cable–NYS

The SRWEC–NYS construction activities are anticipated to occur within the viewshed of Fire Island. This area includes the Fire Island National Seashore, a popular tourism destination that hosts a variety of activities such as sightseeing, hiking, biking, and various beach activities. While the viewshed associated with the construction activity cannot be easily defined due to the mobile nature of installation vessels, it is anticipated that potential temporary visual impacts could occur when these activities occur within 0.5 mi (2,640 ft/1 km) of the Fire Island shoreline. During operation, the SRWEC will be buried beneath the seafloor and will not be visible from above-ground historic properties.

Onshore Facilities

Historic Resources Study Area and PAPE

The OnCS–DC will be the primary visible component of the Onshore Facilities during the operational phase of the Project and therefore the only component that has the potential to result in impacts to above-ground historic properties. The visual character of the 1-mi (1.6-km) HRSA is generally made up of a mix of high-density development, ranging from industrial to residential, and major transportation facilities, which are anticipated to significantly screen potential views of the OnCS–DC beyond 1 mi (1.6 km).

To determine the potential visibility of the OnCS–DC within the OnCS–DC HRSA and establish a PAPE, a lidar viewshed analysis was completed considering the tallest components of the OnCS–DC and screening provided by topography, vegetation, and structures (see Section 4.5.1). The results of the viewshed analysis suggest that approximately 2 percent of the OnCS–DC HRSA (or 0.6 mi² [2 km²]) could potentially have visibility of the OnCS–DC.

Review of the NYSHPO CRIS website determined that one previously identified above-ground historic property is located within the OnCS–DC PAPE. The historic resources survey conducted for the OnCS–DC determined that no additional above-ground historic properties that meet eligibility criteria for listing in the S/NRHP are located within the OnCS–DC PAPE. Based on these analyses, only one above-ground historic property may have visibility of some portion of the OnCS–DC. This property and the extent of potential visibility and potential impacts to its historic setting are discussed in further detail in the Potential Impacts section.

4.6.3.2 Potential Impacts

Construction, O&M, and decommissioning activities associated with the SRWF, SRWEC, and Onshore Facilities have the potential to cause both direct and indirect impacts on above-ground historic properties. IPFs associated with the construction and O&M phases of the Project are identified in Figure 4.6.3-3 and described separately, by phase, for the SRWF, SRWEC, and Onshore Facilities in the following sections. For the decommissioning phase of the Project, impacts are anticipated to be similar to or less adverse than those described for construction; therefore, impacts from decommissioning are not addressed separately in this section. Supporting information on impacts to above-ground historic properties are also presented in further detail in Appendix T and Appendix U.

CONSTRUCTION AND OPERATIONS PLAN

Site Characterization and Assessment of Impacts – Cultural Resources

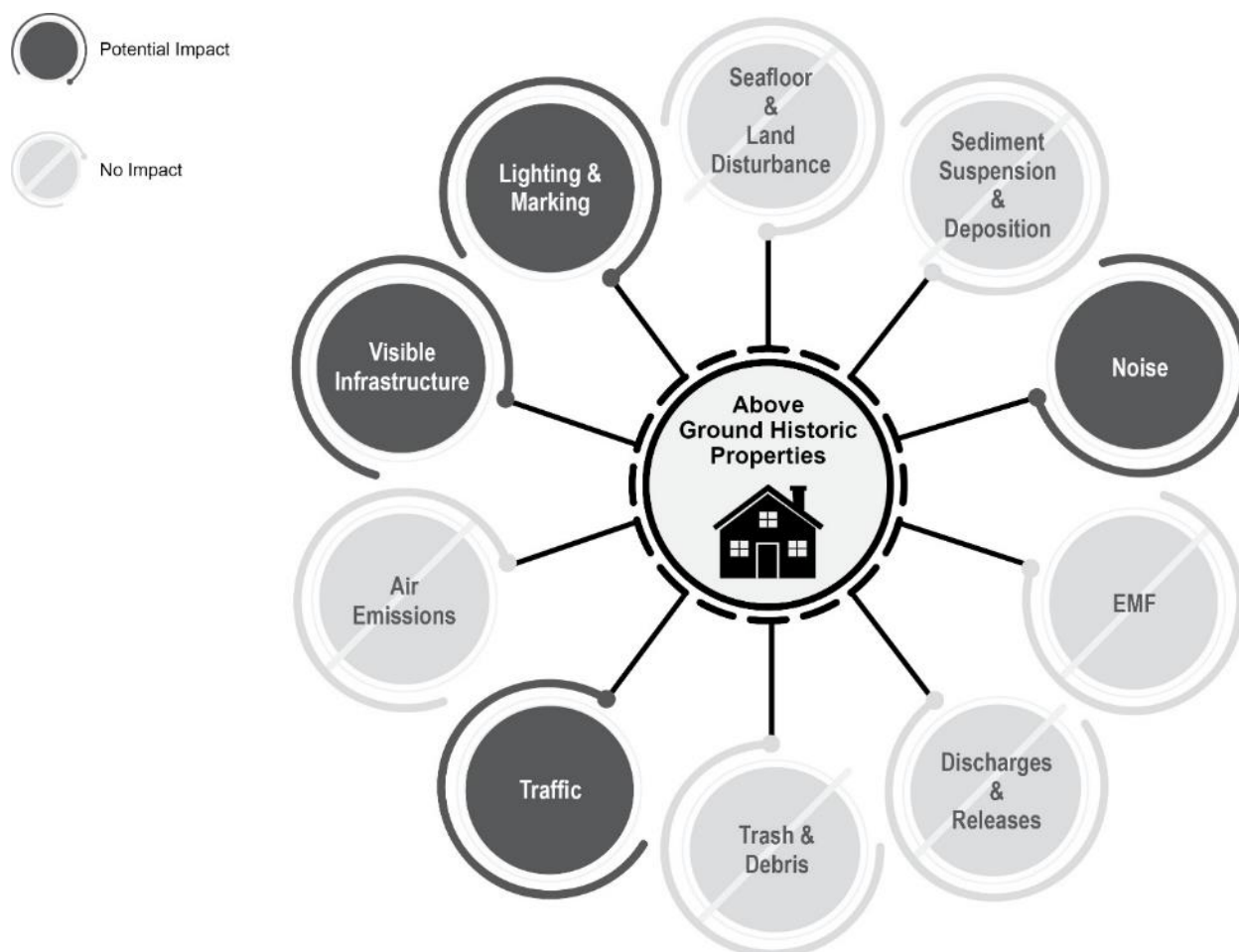

Figure 4.6.3-3 Impact-Producing Factors on Above-Ground Historic Properties

Sunrise Wind Farm

IPFs that could result in effects to historic properties during the construction and O&M phases of the SRWF are described below. A summary of the IPFs that could result in visual impacts to above-ground historic properties are shown in Figure 4.6.3-3. Only those IPFs with anticipated impacts negligible or greater are included in the following discussion.

Construction

As the PAPE is currently delineated, no NHL, NRHP-listed, or NRHP-eligible above-ground historic properties will be directly affected by construction of the SRWF. No physical alterations or demolition of above-ground historic properties are anticipated during construction. During the construction period, however, it is likely that vessels such as jack-up barges, cranes, and support vessels will be visible from onshore historic properties. The presence of these construction vessels along with the WTGs and OCS-DC in varying stages of construction are likely to introduce discordant visual features on the horizon. IPFs associated with construction of the SRWF are anticipated to include Noise, Traffic, Visible Infrastructure, and Lighting and Marking.

CONSTRUCTION AND OPERATIONS PLAN

Site Characterization and Assessment of Impacts – Cultural Resources

Noise

Airborne sound will be generated onshore during construction by vessels and aircraft traffic. However, construction activities associated with the SRWF will take place offshore at distances which would make noise impacts difficult to perceive from shore (Appendix I3). Construction sound from pile driving is not expected to be audible at the nearest shorelines and would comply with relevant federal, state, and local noise standards. An analysis of potential offshore airborne sound impacts is detailed in Appendix I3. The effect of distance and the temporary nature of construction activities could result in a temporary, indirect impact on above-ground historic properties.

Traffic

Marine traffic associated with Project construction is not anticipated to have significant visual impacts to above-ground historic properties located within the PAPE. During construction, the increased flow of ships across the horizon could result in temporary visual impacts, drawing attention to the vessels as they move to and from the Project site. This would have the secondary effect of drawing attention toward the WTGs as they are being erected. However, the potential impacts would be temporary in nature. Therefore, the increase in marine and air traffic would result in negligible visual impacts.

Visible Infrastructure

No physical impacts to above-ground historic properties would occur as a result of construction of the SRWF.

Structures (e.g., WTG, OCS–DC) under installation will likely be visible from the coastline, Vessels associated with the construction of the SRWF, such as jack up barges, will likely be visible in transit from the southern coast of Long Island and along elevated bluffs along the coastline. The relative concentration of equipment associated with the construction of the SRWF could result in temporary visual effects on above-ground historic properties.

Lighting and Marking

Nighttime construction activities will likely require lighting associated with the barges and vessels within the SRWF. Nighttime construction activities are likely to be visible from onshore vantage points and will result in visual impacts due to the presence of direct light sources and skyglow in a previously dark seascape. However, the visibility will be temporary in nature and at times will be obscured from view due to atmospheric conditions or curvature of the Earth. Therefore, lighting associated with construction of the SRWF is anticipated to result in a temporary visual impact on above-ground historic properties.

Operations and Maintenance

Of the two phases of the SRWF, the O&M phase is expected to have the greatest impact on above-ground historic properties due to the potential visual intrusion of offshore facilities on the historic settings of shoreline properties. The sensitivity of individual historic properties located within the PAPE varies depending on the historical relationship of each property to maritime settings and views. IPFs associated with O&M of the SRWF will include Noise, Traffic, Visible Infrastructure, and Lighting and Marking. The impacts are anticipated to persist for the period of operations of the Project.

CONSTRUCTION AND OPERATIONS PLAN

Site Characterization and Assessment of Impacts – Cultural Resources

Noise

Noise generated by WTGs will be minimal and would be generated at distances which would reduce audibility at any above-ground historic property within the PAPE. Sound from the operation of the WTGs and foghorns is not expected to be audible at the nearest shorelines (Appendix I3). Operational sound from the SRWF would comply with relevant federal, state, and local noise standards. Therefore, operational noise associated with the WTG will not impact onshore historic properties. Vessel and air traffic associated with the operational phase of the SRWF will not be out of place given the proximity of the above-ground historic properties to multiple working ports and the abundance of existing vessels in the area. Therefore, it is anticipated that noise associated with traffic during the operation of the SRWF could result in impacts on above-ground historic properties for the duration of SRWF activity.

Traffic

Marine traffic is expected to be less frequent during operation of the SRWF than during construction. Given the relative frequency of seagoing vessels on the horizon within the PAPE, it is not likely that traffic related to the SRWF will be a noticeable change. Therefore, it is anticipated that traffic during the operation of the SRWF will result in temporary visual impact on above-ground historic properties for the duration of SRWF activity.

Visible Infrastructure

To evaluate potential visual impacts during operation of the SRWF, the HRVEA included a viewshed analysis of the potential visibility of the proposed WTGs and OCS–DC, which represent the tallest proposed structures. Utilizing USGS lidar data, a highly detailed digital surface map (DSM) of the SRWF VSA was created. The DSM included the elevations of buildings, trees, and other objects large enough to be resolved by lidar technology. Additionally, a digital terrain model (DTM) was created, representing bare earth conditions. The analysis of potential visibility of the SRWF was based on 123 points representing the proposed WTGs, each with an assumed maximum blade tip height of 968 ft (295 m) AMSL and an assumed viewer height of 6 ft (1.83 m). The viewshed analysis was conducted using ESRI ArcGIS PRO® software with the Spatial Analyst extension and considered curvature of the Earth in the analysis.

Potential turbine visibility, as indicated by the viewshed analyses, is depicted in Appendix Q1, (illustrated in Appendix Q1, Figure 1.2-1 and summarized in Appendix Q1, Table 3.1-1). Within the VSA, the lidar-based viewshed analysis indicates that approximately 5 percent of the land area could have potential views of some portion of the Project based on the availability of an unobstructed line of sight. Visibility will be eliminated in large portions of the VSA where buildings/structures and vegetation screens views toward the Project site. Forest land is the dominant land use within the mainland portions of the VSA (covering approximately 54 percent of the land within a 40-mi [64-km] radius of the SRWF) and will significantly reduce potential SRWF visibility throughout the area. In areas of concentrated human settlement, buildings will also significantly screen outward views. Considering the screening provided by structures, vegetation, and topography, potential SRWF visibility is largely restricted to the ocean shoreline and water bodies immediately inland of the shoreline (e.g., salt ponds and bays).

CONSTRUCTION AND OPERATIONS PLAN

Site Characterization and Assessment of Impacts – Cultural Resources

The SRWF will be visible and will result in a change to the visual setting of historic properties located along the shoreline. The proposed WTGs would be a new feature in the visual setting and views toward the ocean. Due to their scale and form, they are likely to attract viewer attention. In addition, due to the size and scale of the Project, it will occupy relatively large portions of the visible horizon. The minimum distance separating above-ground historic properties from the proposed WTGs is approximately 17 mi (27 km). The distance to shore from the proposed WTGs ranges from 16.7 mi (26.8 km), on Block Island in the Town of New Shoreham, RI, to 26 mi (41 km) from the nearest point on the mainland (south of Narragansett on mainland Rhode Island). Distances from the nearest WTGs from selected shoreline locations within the VSA are represented in Table 4.6.3-1 below. A comprehensive visibility analysis is presented in Attachment A of the HRVEA (Appendix T) that lists the historic properties within the VSA that have potential visibility of the Project, as determined by the viewshed analysis.

Table 4.6.3-1 Distance from WTG to Shoreline within the VSA

Location within the VSA	Distance from Nearest WTG (mi)	Distance from Nearest WTG (km)
Block Island, Town of New Shoreham, RI	17	27
Narragansett, mainland RI	26	41
Montauk Point, NY	31	49
Martha's Vineyard, MA	19	30
Westport, mainland MA	30	49
Nantucket, MA	36	59

Depending on the viewer position relative to the SRWF and distance from the SRWF, some locations (such as Montauk, NY and mainland Rhode Island) are likely to experience minimal visibility. However, the SRWF is likely to occupy a large percentage of the vast horizon available due to its size and scale. Vantage points closer to the SRWF may experience a substantial change to the seascape and horizon resulting from the addition of the SRWF.

Actual SRWF visibility will be limited by several other factors not specifically addressed in the visibility analyses conducted as part of the HRVEA for the Project, including weather conditions, waves on the ocean surface, humidity, and air pollution.

Weather conditions will serve to limit visibility of the Project over significant portions of a given year. A study completed by BOEM in 2017 used NWS data collected for a 10-year period to predict potential offshore visibility using a relational algorithm based on relative humidity. Considering daytime visibility, this study calculated the number of days per season/year during which visibility exceeded 10, 20, and 30 nm (11.5, 23, and 34.5 mi; 19, 37, and 56 km) at least 50 percent and 75 percent of the daylight hours. Considering the 50-percent threshold (50 percent of the observations confirmed visibility at a set distance) the data from Newport, RI suggests that daytime visibility to 20 nm (23 mi; 37 km) would occur over approximately 112 days per year (31 percent). Using the same 50 percent threshold, visibility to 30 nm (34.5 mi; 56 km) would occur during daylight hours over approximately 29 days of a given year (7.9 percent). The average summertime visibility associated with this meteorological station was reported to be 11 nm (12.7 mi; 20 km) and the average annual visibility extends to 15 nm (17 mi; 28 km).

CONSTRUCTION AND OPERATIONS PLAN

Site Characterization and Assessment of Impacts – Cultural Resources

The same study was completed from Martha's Vineyard and suggests that daytime visibility to 20 nm (23 mi; 37 km) occurred on 113 days and visibility to 30 nm (34.5 mi; 56 km) occurred during 32 days of a given year (assuming the 50 percent threshold). From Martha's Vineyard, summertime visibility averaged 10 nm (11.5 mi; 19 km) and annual visibility averaged 14 nm (16 mi; 26 km). Visibility observations from Nantucket suggest a slight reduction in average visibility. From this station, visibility extended to 20 nm (23 mi; 37 km) during 80 days of the year and visibility to 30 nm (34.5 mi; 56 km) occurred during 14 days of the year (both calculations consider the 50 percent threshold). During summer, daytime visibility from Nantucket averages approximately 10 nm (11.5 mi; 19 km), and the average annual daytime visibility extends to 12 nm (14 mi; 22 km) (Wood et Al. 2017).

In addition, sky conditions will also affect a viewer's ability to detect the WTGs on the horizon. For example, overcast days will eliminate hard shadows on the WTGs created by direct sunlight, which will reduce contrast and minimize the ability to perceive the blades or recognize movement. Additionally, on overcast days the white sky color on the horizon will further reduce WTG visibility due to the lack of contrast against the background sky. Conversely, on clear days, when the WTGs are fully front lit or back lit, visibility may be higher. To predict the frequency of each of these conditions, National Climatic Data Center (NCDC) data was analyzed over a six-year period (between 2010 and 2016) for the Block Island and Newport Stations and broken down by cloud cover. The results of this analysis suggest that during daylight hours, clear sky conditions occurred approximately 42 percent of the time, partly cloudy conditions occurred during approximately 4 percent of the time, and overcast sky conditions occurred about 52 percent of the time (EDR 2019).

Impacts may occur to properties for which historic maritime settings and open-ocean views are important aspects of the property's significance for the duration of Project activity, although these impacts may be somewhat mitigated by distance from the SRWF. With regard to potential impacts to above-ground historic properties resulting from offshore wind turbines, BOEM has noted "due to the distance between the reasonably foreseeable wind development and the nearest cultural resources, in most instances exceeding 15 mi (24.1 km), WTGs within individual projects would appear relatively small on the horizon, and the visibility of individual structures would be further affected by environmental and atmospheric conditions such as vegetation, clouds, fog, sea spray, haze, and wave action" (BOEM 2020b).

The visual effects to above-ground historic properties located within 25 mi (40 km) of the Project with potential visibility are expected to be variable due to the large size and scale of the Project and the varying sensitivity of specific historic properties to changes in open-ocean views. The visibility of the proposed WTGs relative to existing views is not necessarily greater from these properties than from other resource locations, but the relevant historic settings may be more expansive and inclusive of the wind farm. Historic lighthouses are the most prominent examples of such properties, as the historic location, function, and design of the properties are associated with distant seaward views. For these properties, the presence of visible twenty-first-century infrastructure on the ocean horizon would likely constitute a change in the historic settings. There are 29 historic lighthouses within the PAPE (Appendix T, Section 3.2.3). National Historic Landmarks may also have an elevated sensitivity to visual impacts due to their location, historic architectural and landscape designs which embrace ocean views, or historic relationships with the open ocean waters.

CONSTRUCTION AND OPERATIONS PLAN

Site Characterization and Assessment of Impacts – Cultural Resources

National Historic Landmarks are subject to additional considerations of potential adverse effects in accordance with Section 110(f) of the NHPA and 36 CFR 800.10. Appendix T provides a detailed summary of individual historic property impact assessments.

Sunrise Wind recognizes that Traditional Cultural Properties associated with Native American communities may be present within the SRWF VSA and PAPE, and such properties would potentially be sensitive to visual impacts from Project construction, O&M, or decommissioning. Sunrise Wind also recognizes that government-to-government consultation between BOEM and Native American tribes under Section 106 may be beneficial to the consideration of such properties and potential Project impacts.

Lighting and Marking

The VIA (Appendix Q1) and the HRVEA (Appendix T) indicate that there is potential visibility of the WTGs and aviation and navigation lighting from the coastlines of New York, Connecticut, Massachusetts, and Rhode Island, resulting in visual impacts to historic properties for the duration of Project activity. The historic properties with the highest potential for visibility of the lighting associated with the SRWF were those that were situated to take advantage of panoramic ocean views, such as the North Light and Block Island Southeast Lighthouse on Block Island in Rhode Island, located 21 mi (38 km) and 17 mi (27 km) from the nearest WTG, respectively, and Gay Head Lighthouse on Martha's Vineyard in Massachusetts, located 22 mi (35 km) from the nearest WTG. These represent examples of NHL and NRHP properties that receive high public use/visitation in the region and that will have at least some visibility of the SRWF. A comprehensive list of areas from which the SRWF will be potentially visible within the PAPE are included in Appendix T (depicted in Attachment A, Figure 3.1-1). The VIA in Appendix Q1 provides further discussion of the visibility of the WTGs within the 40-mi (64-km) radius study area and the methods used to assess potential visual impacts from the SRWF, including viewshed mapping, field reviews, and visual simulations.

Sunrise Wind Export Cable–OCS

Construction

Visual effects to above-ground historic properties associated with the construction of the SRWEC–OCS are anticipated to be short-term and minimal due to the temporary nature of this activity and the anticipated use of construction vessels in an offshore setting, where vessel traffic is commonplace.

Operations and Maintenance

The SRWEC–OCS will consist of cable buried beneath the seafloor and therefore will not result in operational impacts to above-ground historic properties. There will be no visible structures during operation of the SRWEC–OCS. Regular O&M activities would not be expected to result in lighting and marking, noise, or traffic, or involve activities that have potential to cause impacts to above-ground historic properties.

CONSTRUCTION AND OPERATIONS PLAN

Site Characterization and Assessment of Impacts – Cultural Resources

Sunrise Wind Export Cable–NYS

The SRWEC–NYS construction activities are anticipated to occur within the viewshed of portions of Fire Island and may cause temporary visual impacts to above-ground historic properties with views of the nearshore setting. While the viewshed associated with the construction activity cannot be easily defined due to the mobile nature of installation vessels, it is anticipated that potential temporary visual impacts could occur when these activities occur within 0.5 mi (1 km) of the Fire Island shoreline. Fire Island receives an estimated 2.2 million visitors a year, primarily in July and August (NPS 2018). Fire Island National Seashore receiving 391,311 visitors in 2019 (NPS 2020). Due to the mobile and temporary nature of this activity, a historic resources study area has not been defined, and the impacts discussion will generally describe the degree of visual impacts to above-ground historic properties from the SRWEC–NYS. During O&M, the SRWEC will be buried beneath the seafloor and, therefore, will not result in impacts to above-ground historic properties.

Construction

Visible Infrastructure

Construction of the SRWEC–NYS will require excavation for the TJBs and link boxes, which will provide the juncture between the SRWEC–NYS and the Onshore Transmission Cable. Landfall construction activity will include the use of an HDD. The HDD methodology will require temporary use of a Landfall HDD Work Area located onshore within which the TJBs will be installed and where HDD construction activities will occur. An open cut methodology is not being considered to reduce potential impacts to coastal resources inclusive of above-ground historic properties and the mobile seafloor close to the shoreline. The main visible elements of the activities associated with SRWEC–NYS construction will include a pull winch attached to either a piled anchor or a gravity anchor (e.g., a large bulldozer) used to pull the cable through the conduit, as well as the vessels located offshore at the HDD exit pit. The above-ground construction activities will be temporary in nature, lasting from approximately November to March over the course of two years. As such, construction of the SRWEC–NYS is anticipated to result in temporary, negligible impacts to above-ground historic properties.

Noise

Construction activities associated with the SRWEC–NYS would generate noise from heavy equipment performing excavation, drilling, winching of the cable toward shore, and heavy lifting of TJBs, link boxes, and other components. However, this type of noise will be temporary in nature, as described in Appendix I2. As such, assessment, temporary negligible impacts to above-ground historic properties may occur during the construction of the SRWEC–NYS.

Onshore Facilities

IPFs associated with construction and O&M of the Onshore Facilities are anticipated to include Noise, Traffic, Visible Infrastructure, and Lighting and Marking. IPFs and any potential visual impacts to above-ground historic properties associated with construction of the Onshore Facilities are expected to be temporary in duration. IPFs associated with O&M are not expected to result in visual impacts to above-ground historic properties due to the due to the subsurface installation of the onshore cables and the heavily developed nature of the surrounding environment and existing transmission infrastructure, vehicle traffic, lighting, and noise.

CONSTRUCTION AND OPERATIONS PLAN

Site Characterization and Assessment of Impacts – Cultural Resources

Construction

Noise

Construction activities associated with the OnCS–DC would generate noise from heavy equipment performing clearing, grading, excavation, the installation of foundations, and heavy lifting of components. However, this type of noise is not out of context within a working industrial area and will be temporary in nature. Anticipated construction activities expected to last up to approximately 24 months. As such, temporary, negligible impacts to above-ground historic properties are anticipated from noise associated with the construction and decommissioning of the OnCS–DC.

Noise associated with the construction of the Onshore Transmission Cable and Onshore Interconnection Cable components is anticipated to be similar to noise generated during typical municipal road work or utility repairs. This type of noise will be temporary in nature, as described in Appendix I2. By the most conservative assessment, temporary negligible impacts to above-ground historic properties may occur during the construction of the Onshore Transmission Cable and Onshore Interconnection Cable.

Traffic

During construction of the OnCS–DC, vehicular traffic will increase, and construction equipment will be present along the proposed OnCS–DC site, which may result in short-term noise and vibration. Given that the Union Avenue Site is more than 3,100 ft (0.6 mi [1 km]) from the nearest above-ground historic property, only temporary, negligible impacts to above-ground historic properties could result from increased traffic associated with the construction of the OnCS–DC.

Construction of the Onshore Transmission Cable will occur along existing transportation corridors, requiring temporary isolated and/or partial road closures that may result in potential traffic delays, congestion, and narrow roadways. These impacts would be localized and temporary. Therefore, increased traffic associated with the construction of the Onshore Transmission Cable and the Onshore Interconnection Cable is not anticipated to result in impacts to above-ground historic properties due to the location of the activities within existing roads and ROWs in an existing industrial area.

Visible Infrastructure

Construction of the Onshore Transmission Cable, OnCS–DC, and Onshore Interconnection Cable will involve site preparation, duct bank installation, cable installation, cable jointing, final testing, and site restoration with additional steps associated with HDD and other trenchless crossing methods. However, the sites will be mostly screened from existing above-ground historic properties by existing vegetation and structures. Therefore, it is anticipated that only temporary, negligible impacts to above-ground historic properties will occur during the construction phase of the Onshore Facilities.

CONSTRUCTION AND OPERATIONS PLAN

Site Characterization and Assessment of Impacts – Cultural Resources

Lighting and Marking

Construction of the Onshore Transmission Cable, OnCS–DC, and Onshore Interconnection Cable will typically take place during daylight hours. However, nighttime lighting may be required during the construction of the Onshore Transmission Cable, OnCS–DC, and Onshore Interconnection Cable. These lights be consistent with the existing lighting conditions and will be similar to lighting from typical municipal road work or utility repairs in the vicinity due to commercial and industrial areas in the vicinity. As a result, it is anticipated that construction lighting associated with the OnCS–DC and Onshore Interconnection Cable could result in temporary, negligible impacts to above-ground historic properties.

In addition, the Onshore Transmission Cable may require some nighttime construction at sites utilizing trenchless crossings. These include one crossing of a major roadway (i.e., Sunrise Highway [State Route 27]); two railroad crossings (the LIRR); and two waterways (ICW and Carmans River). Construction may not necessarily be screened by existing vegetation or structures. However, given the temporary nature of the construction activities, it is anticipated that construction lighting associated with the Onshore Transmission Cable could result in temporary, negligible impacts to above-ground historic properties.

Operations and Maintenance

Due to minimal anticipated visual intrusion of the Onshore Facilities on the historic setting of adjacent above-ground historic properties, the O&M phase is expected to have minimal visual impacts on above-ground historic properties. Any visual impacts are anticipated to persist for the period of operations and cease thereafter. IPFs associated with the of the Onshore Facilities during the O&M phase include Noise, Traffic, Visible Infrastructure, and Lighting and Marking.

Noise

The Union Avenue Site is located within a developed urban environment. Noise generated by the OnCS–DC is expected to cause minimal increase in ambient sound levels (Appendix I2) and will be difficult to perceive within the immediate industrial context of its location. As such, negligible impacts to historic properties resulting from operational noise are anticipated for the duration of operation.

The Onshore Transmission Cable will have no impact with respect to noise during operations since the cable will be buried beneath existing roads or within other public ROWs and utility-owned or controlled property.

Traffic

O&M of the OnCS–DC will be unmanned during routine operations and will be inspected regularly based on manufacturer-recommended schedules. Personnel will be on site as necessary for any maintenance or repairs. It is likely that no noticeable increase over existing traffic patterns will occur. Therefore, it is anticipated that the traffic will have a long-term negligible impact on historic properties.

The Onshore Transmission Cable route will have no regular maintenance unless there is a failure or malfunction requiring exposure and repair of the cable. If any unforeseen maintenance is required, impacts to traffic from potential traffic detours might occur but will result in no impacts to above-ground historic properties.

CONSTRUCTION AND OPERATIONS PLAN

Site Characterization and Assessment of Impacts – Cultural Resources

Visible Infrastructure

A lidar viewshed analysis was completed to determine the areas within the 1-mi (1.6-km) OnCS–DC HRSA that may have visibility of the OnCS–DC. Results of this analysis suggested that only 5.7 percent of the 1-mi (1.6-km) OnCS–DC HRSA would have visibility of some portion of the OnCS–DC. Only one above-ground historic property within the OnCS–DC PAPE will have visibility of the facility. Waverly Cemetery, an approximately 1.85-acre (0.75 ha) cemetery, is located approximately 0.6 mi (1 km) east of the proposed OnCS–DC on the northeast corner of Washington and Union Avenues in the hamlet of Holtsville, New York. The OnCS–DC will consist of a main enclosure and several lightning masts. The enclosure will be up to 70 ft (21 m) in height. It is anticipated that the tallest component of the OnCS–DC will be the lightning masts, which will have a maximum height of 100 ft (30 m). The area will be graveled and surrounded by a 7-ft (2-m) high fence with a 1-ft (0.3-meter) tall, barbed wire for a total height of 8-ft (2.4-m). Based on these results, it is anticipated that the operations and maintenance of the OnCS–DC would not result in visual impacts and will have no adverse effects to above-ground historic properties for the duration of operation.

Upon completion of the construction phase of the Onshore Transmission Cable, there will not be any visible components of the installed cable and therefore no visual impacts to above-ground historic properties.

Lighting and Marking

Operational lighting associated with the OnCS–DC will be required for the safe and secure operation of the facility. However, the light sources are expected to be lower in profile than the maximum heights used in the viewshed analysis. As such, the lights associated with the OnCS–DC will have minimal visibility from above-ground historic properties. Due to the developed nature of this area, the lights associated with the OnCS–DC are not expected to contribute significantly to the existing sky glow resulting from existing light sources present in the area. Therefore, it is anticipated that the OnCS–DC lighting would have a long-term, negligible effect on historic properties.

4.6.3.3 Proposed Environmental Protection Measures

Sunrise Wind continues to evaluate prudent and feasible options to avoid or minimize visual impacts to above-ground historic properties. A detailed mitigation plan addressing anticipated visual impacts to historic properties, inclusive of Traditional Cultural Properties, will be developed. The mitigation plan will incorporate the results of the *Historic Resources Visual Effects Assessment* (Appendix T) and the *Onshore Above-Ground Historic Properties Report* (Appendix U), and will present property-specific measures for all above-ground historic properties subject to potentially unavoidable adverse effects (per 36 CFR 800.5). To the extent feasible and appropriate, visual impact-related measures presented in the plan will incorporate the views of Native American tribes/nations for whom the affected resources may have traditional cultural significance. Sunrise Wind will continue to consult with BOEM, and engage with Native American tribes/nations, affected SHPOs, and other interested parties, to refine and adapt the proposed mitigation measures and incorporate information gathered from other recent offshore projects.

CONSTRUCTION AND OPERATIONS PLAN

Site Characterization and Assessment of Impacts – Socioeconomic Resources

Sunrise Wind will implement the following environmental protection measures to reduce potential impacts on above-ground historic properties. These measures are based on protocols and procedures successfully implemented for similar offshore projects.

- WTGs will have uniform design, height, and rotor diameter.
- The WTGs will be painted no lighter than Pure White (RAL 9010) and no darker than Light Grey (RAL 7035) as recommended by BOEM and the FAA. Turbines of this color white generally blend well with the sky at the horizon and eliminate the need for daytime warning lights or red paint marking of the blade tips.
- The WTGs and OCS–DC will be lit and marked in accordance with BOEM and USCG requirements for aviation and navigation obstruction lighting, respectively.
- Sunrise Wind will use ADLS or related means (e.g., dimming or shielding) to limit visual impact, pursuant to approval by the FAA and BOEM, commercial and technical feasibility at the time of FDR/FIR approval, and dialogue with stakeholders.
- The Onshore Transmission Cable and Onshore Interconnection Cable will not include any overhead utility poles, thus minimizing potential impacts to adjacent properties.
- The OnCS–DC is sited near an existing substation on a parcel zoned for commercial and industrial/utility use.
- Screening will be implemented at the OnCS–DC to the extent feasible, to reduce potential visibility and noise.

4.7 Socioeconomic Resources

This section describes the socioeconomic resources that could be affected by construction, operation, and decommissioning of the Project; discusses impact-producing factors associated with the Project relative to these resources; and identifies the proposed means to avoid and/or minimize effects on these resources. For the decommissioning phase of the Project, all activities are anticipated to be similar to those described for construction; therefore, impacts from decommissioning are not addressed separately in the following sections. Socioeconomic resources discussed in this section include employment, economics, and demographics; public services; recreation and tourism; commercial and recreational fisheries; other marine uses and coastal land use; and environmental justice.

Regions of influence (ROI) refer to the primary and expanded geographic study areas and were defined to evaluate socioeconomic resources for the Project. These generally include the states, counties, and communities that may be affected by potential Project activities. The primary ROI for overall socioeconomic resources is defined as the area where the Project will occur or where potential ports are located, and includes the states of New York, Connecticut, Maryland, Massachusetts, New Jersey, Rhode Island, and Virginia (Table 4.7-1).

The primary ROI includes existing ports that are being evaluated to support construction and O&M of the Project (Section 3.3.9.4). As described in Section 3.3.9.4, no final determination has been made concerning the specific location(s) of these activities, which could take place at various locations and are expected to serve multiple offshore wind projects and potentially multiple offshore wind-related and other maritime industries.

CONSTRUCTION AND OPERATIONS PLAN

Site Characterization and Assessment of Impacts – Socioeconomic Resources

The expanded ROI includes the communities within the potential viewshed of the SRWF (Section 4.5.1); the potential for effects on property values and recreation/tourism are considered in the expanded ROI.

Table 4.7-1 States, Counties, and Communities within the Socioeconomic Region of Influence

ROIs		State	County	Communities
Primary (Overall Socioeconomic Study Area)	Expanded (Property Value/Tourism Study Area)			
•		New York	Suffolk	Town of Brookhaven, Fire Island CDP, Shirley CDP, Mastic Beach CDP, Brookhaven CDP, Medford CDP, North Bellport CDP, North Patchogue CDP, East Patchogue CDP, Yaphank CDP, Holtsville CDP, Holbrook CDP
•			Suffolk	Town of Brookhaven, Port Jefferson Village
•	•		Suffolk	Town of East Hampton; Montauk CDP
	•		Suffolk	Town of Southold
•			Albany	Albany/Town of Coeymans/Town of Bethlehem
•			New York City	
•			Kings	Borough of Brooklyn
•		Connecticut	New London	New London
	•		New London	North Stonington, Stonington
•		Maryland	Baltimore	Sparrow's Point (Edgemere) /a
	•	Massachusetts	Barnstable	Falmouth, Mashpee
•	•		Bristol	New Bedford
	•		Bristol	Southern shoreline (Dartmouth, Fairhaven, Fall River, New Bedford, Westport)
	•		Dukes	Aquinnah, Chilmark, Edgartown, Gosnold, Oak Bluffs, Tisbury (Martha's Vineyard), West Tisbury
	•		Nantucket	Nantucket
	•		Plymouth	Mattapoisett
•		New Jersey	Gloucester	Paulsboro /b

CONSTRUCTION AND OPERATIONS PLAN

Site Characterization and Assessment of Impacts – Socioeconomic Resources

ROIs		State	County	Communities
Primary (Overall Socioeconomic Study Area)	Expanded (Property Value/Tourism Study Area)			
	•	Rhode Island	Kent	East Greenwich, West Greenwich
	•		Newport	Southern shoreline (Jamestown, Little Compton, Middletown, Newport, Portsmouth, Tiverton)
•			Providence	City of Providence
	•		Washington	Southern shoreline of coast and Block Island (Charleston, Exeter, Hopkinton, Narragansett, New Shoreham, North Kingstown, Richmond, South Kingstown, Westerly)
•		Rhode Island	Washington	Villages of Galilee and Point Judith/Town of Narragansett
•			Washington	Quonset Point/Town of North Kingstown
•		Virginia	Norfolk ³	Norfolk /c
<p>NOTES:</p> <p>/a Edgemere, MD is the (geographically) closest residential area to Sparrow's Point. This area is an unincorporated community and census-designated place (CDP) in Baltimore County.</p> <p>/b This study used the Borough of Paulsboro for census data. The Borough of Paulsboro includes the community of Billingsport, NJ.</p> <p>/c This study used the City of Norfolk and Norfolk International Terminals (NIT) as the locations for this community and port, respectively. The City of Norfolk is considered a county-equivalent area according to the US Census Bureau (USCB).</p>				

4.7.1 Employment, Economics, and Demographics

This section describes the affected environment and potential effects from the construction and operation of the Project as they relate to employment, economics, demographics, housing, and property values. The description of the affected environment and assessment of potential impacts to employment, economics, and demographics were developed by reviewing current public data sources related to socioeconomic resources including state and federal agency-published papers and databases (e.g., USCB, US Bureau of Labor Statistics, Bureau of Economic Analysis, New York State Department of Labor), online data portals and mapping databases (e.g., Social Explorer), environmental studies, and review of publicly available online information from federal and state agencies and public service providers. A description of the employment, economics, and demographics in the Project Area is provided below, followed by an evaluation of potential Project-related impacts.

CONSTRUCTION AND OPERATIONS PLAN

Site Characterization and Assessment of Impacts – Socioeconomic Resources

4.7.1.1 Affected Environment

This section describes the affected environment relative to population, economic, and employment characteristics, and housing and property values. It presents this information for the SRWF, the SRWEC, Onshore Facilities, and potential ports collectively as the primary and expanded ROIs represent a broad area inclusive of all Project components.

Population

Table 4.7.1-1 summarizes USCB data (2000 and 2010 Census and 2014-2018 American Community Survey [ACS] 5-year Estimates) on population and population trends for the states, counties, and communities within the primary ROI. Among the counties within this ROI, Kings County (Brooklyn), NY had the largest population in 2018 (approximately 2.6 million), followed by New York County (Manhattan) with approximately 1.6 million, and then by Suffolk County (approximately 1.5 million). Among the municipalities (cities and towns), aside from New York City, the Town of Brookhaven, NY had the largest population (484,671) (USCB 2018a). New York City (including Brooklyn and Manhattan) has by far the highest population density with 28,111 persons per mi², followed by the City of Providence, RI with 9,747 persons per mi². Albany, NY, North Patchogue, NY, New London, CT, New Bedford, MA, and Norfolk, VA are also fairly dense, each with between approximately 3,800 and 4,800 persons per mi². The median age ranges from a low of 30 in the City of Providence, RI and 31 in Albany, NY, New London, CT, and Norfolk, VA to a high of 54 in Montauk, NY.

Table 4.7.1-1 Population Characteristics within the Primary Region of Interest

Entity	Land Area (mi ² / km ²) /a	Decennial Census Population Count (2000)	Decennial Census Population Count (2010)	ACS Population Estimate (2018)	Population Density per mi ² (2018) /b	Population Change (%) (2000-2018)	ACS Median Age (2018)
NEW YORK	47,126 (122,059)	18,976,457	19,378,102	19,618,453	416	3	39
Suffolk County	912 (2,363)	1,419,369	1,493,350	1,487,901	1,632	5	41
Town of Brookhaven	259 (671)	448,248	486,040	484,671	1,869	8	40
Port Jefferson Village	3 (8)	7,837	7,750	7,871	2,574	0	46
Brookhaven CDP	6 (16)	3,570	3,451	3,531	609	-1	50
Holbrook CDP	7 (18)	27,512	27,195	26,286	3,664	-4	42
Holtsville CDP	7 (18)	17,006	19,714	19,365	2,724	14	44
East Patchogue CDP	8 (21)	20,824	22,469	22,637	2,720	9	42
Fire Island CDP	9 (23)	310	292	249	27	-20	42
Mastic Beach CDP	5 (13)	11,543	12,930	11,953	2,532	4	39
Medford CDP	11 (28)	21,985	24,142	24,247	2,245	10	41

CONSTRUCTION AND OPERATIONS PLAN

Site Characterization and Assessment of Impacts – Socioeconomic Resources

Entity	Land Area (mi ² /km ²) /a	Decennial Census Population Count (2000)	Decennial Census Population Count (2010)	ACS Population Estimate (2018)	Population Density per mi ² (2018) /b	Population Change (%) (2000-2018)	ACS Median Age (2018)
North Bellport CDP	5 (13)	9,007	11,545	11,593	2,367	29	33
North Patchogue CDP	2 (5)	7,825	7,246	7,561	3,832	-3	38
Shirley CDP	11 (28)	25,395	27,854	28,698	2,502	13	36
Yaphank CDP	14 (36)	5,025	5,945	6,390	468	27	38
Town of East Hampton	74 (192) ⁶	19,719	21,457	21,903	295	11	52
Montauk CDP	18 (47)	3,851	3,326	3,655	209	-5	54
Albany County	523 (1,355)	294,565	304,204	307,426	588	4	38
City of Albany	21 (54)	95,658	97,856	97,889	4,574	2	31
Town of Bethlehem	49 (127)	31,304	33,656	34,888	712	11	43
Town of Coeymans	50 (129)	8,151	7,418	7,363	147	-10	43
New York City	300 (777)	8,008,278	8,175,133	8,443,713	28,111	5	37
Kings County	69 (179)	2,465,326	2,504,700	2,600,747	37,490	5	35
New York County	23 (60)	1,537,195	1,585,873	1,632,480	72,053	6	37
CONNECTICUT	4,842 (12,540)	3,405,565	3,574,097	3,581,504	740	5	41
New London County	665 (1,722)	259,088	274,055	268,881	404	4	41
City of New London	6 (16)	25,671	27,620	27,032	4,809	5	31
MARYLAND	9,711 (25,151)	5,296,486	5,773,552	6,003,435	618	13	39
Baltimore County	598 (1,549)	754,292	805,029	827,625	1,383	10	39
Sparrows Point (Edgemere CDP)	11 (28)	9,248	8,669	8,633	795	-7	46
MASSACHUSETTS	7,801 (20,205)	6,349,097	6,547,629	6,830,193	876	8	39
Bristol County	553 (1,432)	534,678	548,285	558,905	1,011	5	41
City of New Bedford	20 (52)	93,768	95,072	95,117	4,757	1	37

CONSTRUCTION AND OPERATIONS PLAN

Site Characterization and Assessment of Impacts – Socioeconomic Resources

Entity	Land Area (mi ² / km ²) /a	Decennial Census Population Count (2000)	Decennial Census Population Count (2010)	ACS Population Estimate (2018)	Population Density per mi ² (2018) /b	Population Change (%) (2000-2018)	ACS Median Age (2018)
NEW JERSEY	7,354 (19,047)	8,414,350	8,791,894	8,881,845	1,208	6	40
Gloucester County	895 (2,318)	254,673	288,288	290,852	903	14	40
Borough of Paulsboro	2 (5)	6,160	6,097	5,937	3,085	-4	45
RHODE ISLAND	1,034 (2,678)	1,048,319	1,052,567	1,056,611	1,022	1	40
Providence County	410 (1,062)	621,602	626,667	634,533	1,550	2	37
City of Providence	18 (47)	173,618	178,042	179,435	9,747	3	30
Washington County	329 (852)	123,546	126,979	126,242	383	2	45
Town of Narragansett	14 (36)	16,361	15,868	15,550	1,122	5	46
Town of North Kingstown	43 (111)	26,326	26,486	26,207	607	-0.5	46
VIRGINIA	39,482 (102,258)	7,078,515	8,001,024	8,413,774	213	19	38
City of Norfolk /c	53 (137)	234,403	242,803	245,592	4,610	5	31

SOURCES: USCB 2000, 2010, 2018a, 2019
 ACS = American Community Survey
 CDP = census designated place
 km² = square kilometers
 NOTES:
 /a Rounded to nearest mi².
 /b Values from USCB and may not be computed from table due to rounding.
 /c Norfolk is a county-equivalent area according to the USCB.

The percent change between the decennial census taken in 2000 and the 2014 to 2018 ACS 5-Year Estimates is provided in Table 4.7.1-1 and shows the changes in population over this time period. Since 2000, for areas in New York, the change in population within the primary ROI ranges from a decrease of 20 percent in Fire Island, NY to an increase of 29 percent in North Bellport, NY. Albany County and North Bellport, NY experienced the most dramatic population changes for this period (27 and 29 percent increase, respectively).

CONSTRUCTION AND OPERATIONS PLAN

Site Characterization and Assessment of Impacts – Socioeconomic Resources

Economy

This section characterizes overall economic conditions by describing the gross domestic product (GDP) of each state, its contribution to the overall national GDP, and the distribution of the civilian workforce by major industry sector. In addition to state-level information, data are presented for the subset of coastal counties that BOEM identified as potentially vulnerable to the impacts of offshore wind development in the RI-MA WEA (ICF 2012) as well as additional areas that may be affected by the Project. As the overall economy is influenced by property values and recreation/tourism, in addition to the primary ROI, this section also presents data for the expanded ROI.

Overall Economy

The GDP represents the market value of goods and services produced by the labor and property located within a geographic area and is influenced to a large degree by the size of that area. GDP serves as a relative indicator of the size of the economies within the region, particularly when viewed as a percentage of the overall national economy. Table 4.7.1-2 summarizes the GDP for New York, Connecticut, Maryland, Massachusetts, New Jersey, Rhode Island, and Virginia for the first quarters of 2018 and 2019.

Table 4.7.1-2 Current-Dollar Gross Domestic Product by State for the First Quarters of 2018 and 2019

State	GDP (in Millions of Dollars Seasonally Adjusted at Annual Rates)		2018 2019 % Change	Percent of the US GDP	
	2018	2019		2018	2019
United States	20,041,047	21,060,062	5	–	–
New York	1,639,572	1,720,788	5	8.2	8.2
Connecticut	270,268	282,002	4	1.3	1.3
Maryland	406,765	421,874	4	2.0	2.0
Massachusetts	558,137	581,718	4	2.8	2.8
New Jersey	613,929	639,841	4	3.1	3.0
Rhode Island	60,503	61,928	2	0.3	0.3
Virginia	523,384	549,997	5	2.6	2.6
SOURCE: BEA 2019					

CONSTRUCTION AND OPERATIONS PLAN

Site Characterization and Assessment of Impacts – Socioeconomic Resources

Within the primary and expanded ROIs, New York has the highest GDP with approximately \$1.6 trillion in the first quarter of 2018 and \$1.7 trillion in the first quarter of 2019, representing an increase of about five percent year-over-year (BEA 2019). Maryland, Massachusetts, New Jersey, and Virginia had relatively similar GDPs (ranging from approximately \$422 billion to \$640 billion), and each increased by four to five percent from 2018 to 2019. Connecticut and Rhode Island had the smallest GDPs of all the states in the ROI (\$282 billion and \$62 billion). Rhode Island only had a two percent change from 2018 to 2019. New York comprises eight percent of the national GDP, while Connecticut, Maryland, Massachusetts, New Jersey, and Virginia comprise approximately one to three percent each, and Rhode Island comprises less than one percent of the national GDP (BEA 2019).

Table 4.7.1-3 and Table 4.7.1-4 present the employed population by industry in the primary ROI. As shown in the table, the percentages across geographies are similar for a number of industries including education and health care. Based on the *2014-2018 ACS 5-Year Estimates*, between 22 and 28 percent of the civilian population in each geography is employed in the educational services and health care and social assistance industry (USCB 2018a). Three other categories of employment are important industries in the ROIs, representing as much as 16 percent of employment in each geography:

- Retail trade;
- Professional, scientific, and management, and administrative and waste management services; and
- Arts, entertainment, and recreation, and accommodation and food services.

Manufacturing and construction, while reaching as much as 16 percent in certain regions, are less prevalent sources of employment in the ROIs overall (most regions exhibited less than 10 percent). Counties within the primary and expanded ROIs have between five and nine percent of persons employed in the finance and insurance, and real estate and rental and leasing industry. New London County, CT had the lowest percentage (five percent), which is significantly lower than in Connecticut as a whole (nine percent). This county correspondingly had a notably higher percentage of residents employed in the arts and related industries (15 percent, compared with eight percent in Connecticut overall). The agriculture, forestry, fishing and hunting, and mining industry employs just one percent or less of the civilian workforce in each geography.

CONSTRUCTION AND OPERATIONS PLAN

Site Characterization and Assessment of Impacts – Socioeconomic Resources

Table 4.7.1-3 Percent Employed Civilian Population by Industry in the States in the Primary (and Expanded) Region of Interest

Industry	Percent Employed						
	NY	CT	MD	MA	NJ	RI	VA
Agriculture, forestry, fishing and hunting, and mining	1	<1	1	<1	<1	1	1
Construction	6	6	7	6	6	6	7
Manufacturing	6	11	5	9	8	11	7
Wholesale trade	2	3	2	2	3	2	2
Retail trade	10	11	10	10	11	12	11
Transportation and warehousing, and utilities	5	4	5	4	6	4	4
Information	3	2	2	2	3	2	2
Finance and insurance, and real estate and rental and leasing	8	9	6	7	9	7	6
Professional, scientific, and management, and administrative and waste management services	12	12	16	14	13	10	15
Educational services, and health care and social assistance	28	27	24	28	24	27	22
Arts, entertainment, and recreation, and accommodation and food services	10	8	9	9	8	11	9
Other services, except public administration	5	5	6	5	4	5	5
Public administration	5	4	11	4	4	4	9
SOURCE: USCB 2018a							

CONSTRUCTION AND OPERATIONS PLAN

Site Characterization and Assessment of Impacts – Socioeconomic Resources

Table 4.7.1-4 Percent Employed Civilian Population by Industry in the Counties in the Primary Region of Interest

Industry	County										
	Albany, NY	Suffolk, NY	NYC, NY/a	New London, CT	Baltimore, MD	Bristol, MA	Gloucester, NJ	Newport, RI	Providence, RI	Washington, RI	Norfolk, VA /b
Agriculture, forestry, fishing, hunting, mining	<1	1	<1	1	<1	<1	1	1	<1	1	<1
Construction	4	8	5	6	6	7	7	7	5	6	8
Manufacturing	5	7	3	13	5	11	8	7	12	10	7
Wholesale trade	2	3	2	2	2	3	4	2	2	2	2
Retail trade	10	12	9	11	11	13	11	9	13	11	12
Transportation and warehousing, and utilities	4	6	6	4	5	4	6	3	4	3	5
Information	2	3	4	2	2	2	2	2	2	1	2
Finance and insurance, real estate, rental and leasing	7	7	10	5	8	6	7	7	7	6	6
Professional, scientific, and management, and administrative and waste management services	11	12	14	9	13	9	11	12	10	10	11
Educational services, and health care and social assistance	28	27	27	24	27	27	28	27	27	28	23

CONSTRUCTION AND OPERATIONS PLAN

Site Characterization and Assessment of Impacts – Socioeconomic Resources

Industry	County										
	Albany, NY	Suffolk, NY	NYC, NY/a	New London, CT	Baltimore, MD	Bristol, MA	Gloucester, NJ	Newport, RI	Providence, RI	Washington, RI	Norfolk, VA /b
Arts, entertainment, recreation, food services, accommodation	9	7	11	15	8	9	7	13	10	13	13
Other services, except public administration	5	4	5	4	5	4	4	6	5	4	5
Public administration	12	5	4	5	8	4	5	5	4	4	9
SOURCE: USCB 2018a NOTES: /a Includes Kings and New York Counties. /b Norfolk is considered a county-equivalent area according to the USCB.											

CONSTRUCTION AND OPERATIONS PLAN

Site Characterization and Assessment of Impacts – Socioeconomic Resources

Recreation and Tourism Economy

BOEM identified coastal counties (and in several cases, hotspots within particular counties) along the US East Coast, from Maine to Georgia, as a function of their potential to experience socioeconomic impacts, both beneficial and detrimental, associated with each phase (planning, construction, and decommissioning) of wind facility development (ICF 2012). Criteria used to rank and evaluate the potential sensitivity of coastal areas of interest to offshore wind development included counties where:

- Ocean recreation and tourism account for a sizable percentage of the location's tourism economy;
- Ocean recreation and tourism account for a sizable percentage of the location's marine economy;
- Tourism accounts for a large percentage of the location's economy;
- The location has a large number of establishments related to coastal and water recreation;
- The location has a high percentage of natural or historic and cultural areas; and
- The location has significant development along the coast (ICF 2012).

Of the 113 geographic areas (i.e., counties and hotspots within particular counties) assessed by BOEM, 16 were within the states within the expanded ROI, including eight in New York, four in Connecticut, eight in Massachusetts, and six in Rhode Island (ICF 2012). All counties within the primary and expanded ROIs were included in BOEM's assessment, with the exception of Baltimore County, MD, Gloucester County, NJ, the County of Albany, NY, and Norfolk, VA. Based on the methodology presented by ICF (2012), the recreation and tourism industries in these counties are less likely to be sensitive to offshore wind development as compared to those included in BOEM's assessment, likely because they are located further inland from the coast, or were not located in proximity to an area considered for offshore wind development.

Table 4.7.1-5 summarizes the significance of the ocean economy, including ocean-related tourism and recreation, to each geography within the expanded ROI. Gloucester County, NJ had the lowest percentage of ocean-related tourism jobs (27.5 percent), followed by New London County, CT (36.2 percent), while Nantucket County, MA had the highest percentage of ocean-related tourism jobs (99.5 percent) (with relatively few establishments). The number of employees per ocean-related establishment was far higher in Gloucester and New London Counties (approximately 43 and 38, respectively) than in the other counties within the expanded ROI (ranging from approximately 9 in Dukes County, MA to 23 in Washington County, RI) (ICF 2012). In terms of ocean-related GDP from tourism and recreation, the total value of goods produced and services provided in the ocean-related tourism and recreation economy was most significant in Suffolk County, NY (\$1.9 billion), followed by \$1.1 billion in Barnstable County, MA, and least significant in Gloucester County, NJ (\$52.3 million). Collectively, the counties of Rhode Island had a combined GDP of nearly \$1.8 billion.

CONSTRUCTION AND OPERATIONS PLAN

Site Characterization and Assessment of Impacts – Socioeconomic Resources

Table 4.7.1-5 Summary of Ocean-related Tourism Indicators within the Expanded Region of Interest

States and Communities in the Expanded ROI /a	Ocean Jobs Related to Tourism and Recreation, 2018 (%)	Ocean Establishments Related to Tourism and Recreation, 2018	Ocean-related Establishments/ Employment, 2018	Ocean-related GDP from Tourism and Recreation (in millions of 2018 \$)
NEW YORK				
Albany County	N/A	N/A	38/625	N/A
Suffolk County	87.9	2,741	3,032/43,138	1,900
CONNECTICUT				
New London County	36.2	490	541/20,673	374.3
MARYLAND				
Baltimore County	60.2	391	483/9,350	209.4
MASSACHUSETTS				
Barnstable County	94.0	1,222	1,356/19,247	1,100
Bristol County	48.9	193	509/6,964	105.8
Dukes County	97.5	167	183/1,587	120.1
Nantucket County	99.5	134	142/1,739	159.7
Plymouth County	87.5	642	741/11,192	400.9
NEW JERSEY				
Gloucester County	27.5	85	130/5,579	52.3
RHODE ISLAND				
Kent County	96.4	373	388/7,862	321.8
Newport County	82.0	421	462/8,847	444.1
Providence County	92.1	873	928/16,541	700.0
Washington County	53.5	441	513/11,896	327.6
Block Island, Washington County	N/A	N/A	N/A	N/A
SOURCE: NOAA, Office for Coastal Management, DigitalCoast, ENOW Explorer, 2018.				
NOTES:				
N/A = not available				

CONSTRUCTION AND OPERATIONS PLAN

Site Characterization and Assessment of Impacts – Socioeconomic Resources

Employment

Employment characteristics for states and counties in the primary ROI are summarized in Table 4.7.1-6. Among the counties, Kings County, NY has the largest labor force with approximately 1.2 million workers (as of 2018), while Washington County, RI has the smallest labor force with approximately 69,000 workers (BLS 2020). Unemployment rate is low throughout and ranges from 3.4 percent to 4.4 percent, with the highest rate in Providence County, RI. Per capita personal income in 2017 ranged from \$40,094 to \$65,758 (except for Manhattan, which had the highest at \$175,960) and was lowest in Norfolk, VA and highest in Suffolk County, NY (BEA 2018). At the state level, the labor force is most significant in New York (more than 9.5 million) and least significant in Rhode Island (557,000 workers).

Table 4.7.1-6 Employment Characteristics for States and Counties in the Primary Region of Interest

Entity	Labor Force (2018)	Employment (2018)	Unemployment (2018)	Unemployment Rate (%) (2018)	Per Capita Personal Income (\$) (2017)
NEW YORK	9,542,000	9,147,000	395,000	4.1	64,540
Albany County	157,500	151,700	5,800	3.7	58,048
Kings County	1,201,400	1,149,800	51,600	4.3	48,758
New York County	914,200	880,100	34,100	3.7	175,960
Suffolk County	777,784	747,832	29,952	3.9	65,758
CONNECTICUT	1,898,000	1,819,000	79,000	4.1	71,823
New London County	137,463	132,032	5,431	4.0	56,725
MARYLAND	3,184,000	3,051,000	132,000	4.2	60,847
Baltimore County	450,366	432,164	18,202	4.0	59,130
MASSACHUSETTS	3,823,000	3,693,000	130,000	3.4	67,630
Bristol County	302,918	289,955	12,963	4.3	51,298
NEW JERSEY	4,418,000	4,232,000	186,000	4.2	64,537
Gloucester County	147,175	140,940	6,235	4.2	52,506
RHODE ISLAND	557,000	534,000	23,000	4.1	52,786
Providence County	325,587	311,259	14,328	4.4	46,470
Washington County	69,005	66,529	2,476	3.6	62,357
VIRGINIA	4,352,000	4,224,000	127,000	2.9	55,105
Norfolk /a	111,524	107,496	4,028	3.6	40,094

SOURCE: BEA 2018; BLS 2019, 2020; Connecticut Department of Labor 2018; Rhode Island Department of Labor and Training 2019a, b, c; New York State Department of Labor 2019; Massachusetts Executive Office of Labor and Workforce Development 2019

NOTE:
/a Norfolk is a county-equivalent area according to the USCB.

CONSTRUCTION AND OPERATIONS PLAN

Site Characterization and Assessment of Impacts – Socioeconomic Resources

Housing

The vacancy status of the region's housing serves as an indicator of the housing market and whether non-local construction workers will be able to find short-term accommodations. The USCB defines a housing unit as "a house, an apartment, a mobile home, a group of rooms or a single room that is occupied (or, if vacant, intended for occupancy) as separate living quarters" (USCB 2017). Boats, recreational vehicles, vans, tents, and other similar quarters are only included if they are occupied as a current place of residence by those reporting their housing.

Table 4.7.1-7 summarizes the total number of housing units, vacant units, vacancy rates for rentals and ownership, as well as their corresponding median value or gross rent for the primary ROI. Homeowner vacancy rates in this ROI are low, between 0 percent (Port Jefferson, Holbrook, North Bellport, and Yaphank, NY) and 4.7 percent (City of New London, CT and Mastic Beach, NY). Meanwhile, rental vacancy rates are generally higher and more varied, ranging from 0 percent (Port Jefferson, Brookhaven, Fire Island, Medford, North Patchogue, and Shirley, NY) to 50.9 percent (Montauk, NY). The Montauk, NY rental vacancy value seems to be an outlier; it is likely reflective of Montauk's seasonal housing. The next highest rental vacancy rate is 14.6 percent (Town of East Hampton, NY) (USCB 2018a).

Table 4.7.1-7 Housing Characteristics within the Primary Region of Interest

Entity	Total Housing Units	Vacant Housing Units	Homeowner Vacancy Rate (%)	Rental Vacancy Rate (%)	Median Value (dollars)	Median Gross Rent (dollars)
NEW YORK	8,287,087	970,550	1.7	4.3	302,200	1,240
Suffolk County	575,162	87,181	1.4	5.7	386,800	1,698
Town of East Hampton	22,035	13,029	0.8	14.6	850,000	1,867
Montauk CDP	4,631	3,251	0.8	50.9	890,200	2,302
Town of Brookhaven	175,772	15,170	1.3	4.7	338,800	1,736
Port Jefferson Village	3,230	200	0.0	0.0	501,700	1,794
Brookhaven CDP	1,242	118	0.7	0.0	421,200	1,352
Holbrook CDP	9,353	499	0.0	5.2	364,700	1,906
Holtsville CDP	6,843	289	0.5	6.1	355,800	1,642
East Patchogue CDP	8,641	393	0.5	1.5	321,200	1,407
Fire Island CDP	3,473	3,397	2.9	0.0	425,000	N/A
Mastic Beach CDP	4,915	798	4.7	2.0	212,200	1,791
Medford CDP	8,328	372	0.6	0.0	311,200	1,965
North Bellport CDP	3,830	300	0.0	6.1	277,000	2,143
North Patchogue CDP	2,484	87	2.3	0.0	300,400	1,541
Shirley CDP	9,150	744	2.6	0.0	259,900	2,088
Yaphank CDP	2,063	69	0.0	5.1	311,300	2,125
Albany County	140,830	14,822	1.7	4.7	218,100	993

CONSTRUCTION AND OPERATIONS PLAN

Site Characterization and Assessment of Impacts – Socioeconomic Resources

Entity	Total Housing Units	Vacant Housing Units	Homeowner Vacancy Rate (%)	Rental Vacancy Rate (%)	Median Value (dollars)	Median Gross Rent (dollars)
City of Albany	48,625	7,418	3.6	5.8	173,300	951
Town of Bethlehem	14,830	727	0.6	5.9	269,900	1,185
Town of Coeymans	3,458	400	2.8	7.8	178,700	854
New York City	3,472,354	318,251	1.9	3.4	570,500	1,396
Kings County	1,035,746	84,890	1.7	3.4	665,300	1,374
New York County	874,237	116,104	2.6	4.6	944,600	1,682
CONNECTICUT	1,512,305	144,931	1.8	6.5	272,700	1,156
New London County	123,001	15,599	2.6	5.1	239,000	1,099
City of New London	12,645	1,670	4.7	5.2	181,300	958
MARYLAND	2,437,740	245,222	1.7	6.2	305,000	1,357
Baltimore County	336,554	23,641	1.7	6.7	255,400	1,263
Sparrows Point (Edgemere CDP)	3,539	281	1.8	1.1	274,400	1,322
MASSACHUSETTS	2,882,739	280,825	1.0	3.8	366,800	1,225
Bristol County	234,458	17,840	1.2	4.8	290,100	872
City of New Bedford	43,262	4,020	1.5	6.5	218,100	819
NEW JERSEY	3,605,401	392,039	1.7	5.2	327,900	1,295
Gloucester County	113,024	8,437	1.3	6.8	216,700	1,186
Borough of Paulsboro	3,137	585	0.0	8.9	112,700	1,039
RHODE ISLAND	467,412	56,527	1.8	5.8	249,800	981
Providence County	265,991	27,820	2.1	6.1	223,600	945
City of Providence	72,860	11,222	3.0	7.3	192,100	972
Washington County	63,737	14,626	1.6	5.8	328,300	1,100
Town of Narragansett	10,156	3,478	2.7	4.4	418,600	1,532
Town of North Kingstown	11,513	1,101	0.9	4.7	340,600	983
VIRGINIA	3,491,091	362,676	1.6	5.7	264,900	1,202
Norfolk	97,257	9,102	2.9	6.4	199,400	1,031
SOURCE: USCB 2018a						

CONSTRUCTION AND OPERATIONS PLAN

Site Characterization and Assessment of Impacts – Socioeconomic Resources

Table 4.7.1-8 summarizes the 2018 vacancy status in the primary ROI by type of vacancy (e.g., tenure) for those units that could be available to non-local construction or O&M workers, that is, units not already rented or sold. It illustrates the key role that “seasonal, recreational, or occasional use” and “other vacant” units play in the local housing supply. Among the counties in the primary ROI, these two occupancy uses comprise more than half of the vacant units. Moreover, they comprise approximately 90 percent of the vacant units in Washington County, RI and more than 85 percent of the vacant units in Suffolk County, NY (USCB 2018b). Both “seasonal, recreational, or occasional use” and “other vacant” uses are associated with seasonal tourism or secondary vacation homes, with other vacant units often used by a caretaker or janitor. The availability of seasonal units would typically be quite limited during peak summer-construction periods.

Some ports, including Brooklyn, Port Jefferson, Montauk, Davisville/Quonset Point, and Galilee, would only be used for O&M, not construction, and therefore would have fewer non-local construction workers in the area than the other potential port locations.

For the towns in New York (the area of the primary ROI with the most Project elements), of the approximately 13,000 vacant units noted in Table 4.7.1-7 for the Town of East Hampton, 247 were reported “for rent,” 62 units were “for sale,” and the balance were split between “seasonal, recreational, or occasional use,” “for migrant workers,” and “other vacant” housing (USCB 2018b). Similarly, of the nearly 14,000 vacant units in the Town of Brookhaven, 1,700 were reported “for rent,” approximately 1,600 units were “for sale,” and the balance were split between “seasonal, recreational, or occasional use,” “for migrant workers,” and “other vacant” housing (USCB 2018b).

Other housing options will be short-term accommodations, which for purposes of this COP, are defined as hotel and motel rooms, and sites for recreational vehicles. The need for these short-term housing units is anticipated primarily near the staging ports and Onshore Facilities since much of the workforce for offshore construction will be housed offshore.

Table 4.7.1-8 Vacant Housing Characteristics within the Primary Region of Interest

Entity	Total Vacant Units /a	For Rent	For Sale Only	For Seasonal, Recreational, or Occasional Use	For Migrant Workers	Other Vacant
NEW YORK	890,510	152,802	68,359	342,825	2,331	324,193
Suffolk County	82,703	5,878	5,615	53,539	405	17,266
Suffolk County % Distribution /b	–	7	7	65	<1	21
Town of East Hampton	13,021	247	62	12,367	150	195
Montauk	3,251	201	9	2,958	27	56
Town of Brookhaven	13,938	1,700	1,623	4,498	23	6,094
Port Jefferson	141	0	0	0	0	141
Brookhaven CDP	118	0	6	27	0	85
Holbrook CDP	409	96	0	91	0	222

CONSTRUCTION AND OPERATIONS PLAN

Site Characterization and Assessment of Impacts – Socioeconomic Resources

Entity	Total Vacant Units /a	For Rent	For Sale Only	For Seasonal, Recreational, or Occasional Use	For Migrant Workers	Other Vacant
Holtsville CDP	236	78	29	18	0	111
East Patchogue CDP	393	46	29	145	0	173
Fire Island CDP	3,394	0	2	3,362	0	30
Mastic Beach CDP	753	23	147	231	0	352
Medford CDP	289	0	40	0	0	249
North Bellport CDP	280	99	0	14	0	167
North Patchogue CDP	87	48	39	0	0	87
Shirley CDP	676	0	180	159	0	337
Yaphank CDP	69	19	0	21	0	29
Albany County	13,157	2,690	1,237	1,707	0	7,523
Albany County % Distribution	–	20	9	13	0	57
City of Albany	7,418	1,608	568	137	0	4,365
Town of Bethlehem	727	221	59	109	0	163
Town of Coeymans	400	84	59	59	0	198
New York City	281,657	75,845	19,658	71,557	1,090	113,707
Kings County	84,890	23,723	4,942	9,230	49	36,267
Kings County % Distribution /b	–	28	6	11	0	43
New York County	116,104	27,668	4,929	45,970	195	23,736
New York County % Distribution /b	–	24	4	40	0	20
CONNECTICUT	131,961	31,889	16,808	29,855	93	53,316
New London County	14,399	1,932	1,877	5,083	0	5,507
New London County % Distribution /b	–	13	13	35	0	38
City of New London	1,602	388	187	176	0	851
MARYLAND	229,303	48,476	25,716	59,900	211	95,000
Baltimore County	21,607	7,755	3,591	1,170	31	9,060
Baltimore County % Distribution /b	–	36	17	5	0	42
Sparrows Point (Edgemere CDP)	259	14	28	31	0	186
MASSACHUSETTS	254,652	39,087	16,817	127,508	84	71,156
Bristol County	16,597	4,062	1,702	2,836	23	7,974

CONSTRUCTION AND OPERATIONS PLAN

Site Characterization and Assessment of Impacts – Socioeconomic Resources

Entity	Total Vacant Units /a	For Rent	For Sale Only	For Seasonal, Recreational, or Occasional Use	For Migrant Workers	Other Vacant
Bristol County % Distribution ²	–	21	20	24	2	34
City of New Bedford	3,851	1,625	241	136	0	1,849
NEW JERSEY	366,466	63,742	35,674	135,527	231	131,272
Gloucester County	7,634	1,507	1,132	271	0	4,724
Gloucester County % Distribution ²	–	20	15	4	0	62
Borough of Paulsboro	515	84	0	0	0	431
RHODE ISLAND	52,004	10,059	4,620	17,699	0	19,626
Providence County	24,820	7,161	2,716	1,297	0	13,646
Providence County % Distribution ²	–	29	11	5	0	55
City of Providence	10,200	3,151	675	357	0	6,017
Washington County	14,189	769	580	11,129	0	1,711
Washington County % Distribution /b	–	5	4	78	0	12
Town of Narragansett	3,478	94	129	3,026	0	207
Town of North Kingstown	937	116	74	389	0	358
VIRGINIA	329,152	63,404	33,483	88,357	370	143,538
Norfolk	8,420	3,426	1,150	438	0	3,406
Norfolk % Distribution /b	–	41	14	5	0	40
SOURCE: USCB 2018b						
NOTES:						
/a Not including those rented or sold.						
/b Percent distribution reflects the distribution of the total number of vacant units in each county by type of vacancy (e.g., tenure).						

CONSTRUCTION AND OPERATIONS PLAN

Site Characterization and Assessment of Impacts – Socioeconomic Resources

Property Values

As shown in Table 4.7.1-7 above, median home values in the communities within the primary ROI range from approximately \$173,300 in Albany, NY and \$179,000 in Coeymans, NY to \$890,000 in Montauk, NY and \$944,600 in Manhattan. At \$192,100, the median home value in the City of Providence, RI is similar to that in the City of New London, CT (\$181,300), while the Towns of North Kingstown and Narragansett in Rhode Island have median home values (\$340,600 and \$418,600, respectively) nearly or more than double that of the City of New London, CT. New Bedford, MA and Norfolk VA, had slightly higher median home values compared to the City of Providence, RI and the City of New London, CT. These trends are similar with regard to median gross rent, with Montauk, NY having the highest value (\$2,302) and Coeymans, NY the lowest value (\$854). The City of Providence, RI (\$972) and New London, CT (\$958) also have similar values, and the Towns of Narragansett and North Kingstown in Rhode Island (\$1,352 and \$983, respectively) have higher values (USCB 2018a). The median reported gross rent is slightly higher in the Town of East Hampton, NY compared to the Town of Brookhaven, NY (\$1,867 and \$1,736, respectively).

Table 4.7.1-9 and Table 4.7.1-10 summarize the number of owner-occupied housing units across the region and the percent distribution of their corresponding housing values in 2018. Among the counties within the primary and expanded ROI, each has less than 10 percent of their owner-occupied housing unit values between \$0 and \$99,999 (USCB 2018c). Conversely, the percentage of units valued at \$500,000 or greater spanned a much larger range from three percent in Gloucester County, NJ to 90 percent in Nantucket County, MA (USCB 2018c), indicating some counties are wealthier than others. At the state level, New York and Massachusetts have a quarter or more of their owner-occupied housing unit values at greater than \$500,000. Maryland, New Jersey, and Virginia each have about one-fifth of their owner-occupied housing units in that highest category, indicating similar wealth of the housing stock. Connecticut, and Rhode Island have lesser percentages of their units valued at greater than \$500,000 (17, 11, and 7 percent, respectively) (USCB 2018c).

CONSTRUCTION AND OPERATIONS PLAN

Site Characterization and Assessment of Impacts – Socioeconomic Resources

Table 4.7.1-9 Housing Values within the States in the Primary and Expanded Region of Interest

	NY	CT	MD	MA	NJ	RI	VA
Total Number of Owner-Occupied Housing Units	3,943,356	907,134	1,463,941	1,621,053	2,054,413	247,565	2,070,879
\$0 to \$99,999 (%)	15	6	7	3	6	5	12
\$100,000 to \$124,999 (%)	6	4	3	2	3	3	4.9
\$125,000 to \$149,999 (%)	5	5	3	2	3	5	5.2
\$150,000 to \$174,999 (%)	6	8	6	4	5	10	7.2
\$175,000 to \$199,999 (%)	4	7	5	4	5	9	6.2
\$200,000 to \$249,999 (%)	7	14	13	10	11	18	11.7
\$250,000 to \$299,999 (%)	7	13	12	11	12	14	10.0
\$300,000 to \$399,999 (%)	13	18	20	21	21	18	14.7
\$400,000 to \$499,999 (%)	11	9	12	15	13	8	9.3
\$500,000 to \$749,999 (%)	14	9	12	17	14	7	11.9
\$750,000 to \$999,999 (%)	6	3	4	6	5	2	4.4
\$1,000,000 to \$1,499,999 (%)	3	2	1.8	3	2	1	1.8
\$1,500,000 to \$1,999,999 (%)	1	1	0.5	1	1	<1	0.5
\$2,000,000 or more (%)	2	2	0.7	1	1	1	0.5
\$500,000 or more (%)	27	17	19	28	23	11	19
SOURCE: USCB 2018a, b, c							

CONSTRUCTION AND OPERATIONS PLAN

Site Characterization and Assessment of Impacts – Socioeconomic Resources

Table 4.7.1-10 Housing Values within the Counties in the Primary and Expanded Region of Interest

	Albany, NY	Kings, NY	New York, NY	Suffolk, NY	New London, CT	Baltimore, MD	Barnstable, MA	Bristol, MA	Dukes, MA	Nantucket, MA	Plymouth, MA	Gloucester, NJ	Kent, RI	Newport, RI	Providence, RI	Washington, RI	Norfolk, VA
Total Number of Owner-Occupied Housing Units	71,253	285,330	182,949	390,897	71,459	205,641	74,991	135,377	4,930	2,576	141,482	83,845	48,097	21,849	127,394	36,608	38,029
\$0 to \$99,999 (%)	9	4	4	3	7	6	2	4	1	1	4	7	6	4	6	3	8
\$100,000 to \$124,999 (%)	5	1	1	1	5	4	1	2	<1	<1	1	5	4	2	4	2	8
\$125,000 to \$149,999 (%)	7	1	<1	1	5	5	1	2	<1	1	1	8	6	1	7	1	9
\$150,000 to \$174,999 (%)	11	1	1	2	11	9	2	5	0	<1	3	13	12	3	13	3	13
\$175,000 to \$199,999 (%)	11	1	<1	2	9	8	2	6	<1	<1	3	11	13	2	11	4	13
\$200,000 to \$249,999 (%)	21	3	1	6	17	18	7	18	2	1	11	19	21	10	21	14	18
\$250,000 to \$299,999 (%)	13	3	2	11	15	13	12	18	1	1	13	15	13	11	13	17	10
\$300,000 to \$399,999 (%)	15	9	5	29	17	17	28	24	11	3	27	15	15	23	15	27	9
\$400,000 to \$499,999 (%)	5	11	10	19	7	9	17	12	14	3	15	4	6	15	6	12	5
\$500,000 to \$749,999 (%)	3	27	18	17	5	9	17	8	32	17	15	2	4	16	4	11	5
\$750,000 to \$999,999 (%)	1	17	14	6	2	2	6	2	21	19	5	<1	2	6	1	4	2
\$1,000,000 to \$1,499,999 (%)	<1	13	14	2	1	1	3	1	8	23	2	<1	<1	4	<1	2	1
\$1,500,000 to \$1,999,999 (%)	<1	5	8	1	<1	<1	1	<1	4	9	1	<1	<1	1	<1	1	<1
\$2,000,000 or more (%)	<1	6	24	1	<1	<1	1	<1	7	22	1	<1	<1	2	<1	1	<1
\$500,000 or more (%)	4	68	79	27	8	12	29	11	72	90	24	3	6	30	6	19	8

SOURCE: USCB 2018a
 NOTES: Norfolk is a county-equivalent area according to the USCB.

This page intentionally left blank

CONSTRUCTION AND OPERATIONS PLAN

Site Characterization and Assessment of Impacts – Socioeconomic Resources

4.7.1.2 Potential Impacts

Project construction, O&M, and decommissioning activities will generate local and regional economic benefits in terms of job creation, increased spending, and revenues from taxes. Adverse economic effects could occur if, for example, a project generated traffic conditions that were sufficiently persistent, severe, or disruptive so as to adversely impact existing businesses over an extended duration. However, with the implementation of proposed environmental protection measures, no Project IPFs were identified that would have a measurable adverse effect to employment, economics, and demographics. The Project was sited, planned, and designed to avoid and minimize impacts. The anticipated Project employment, economic, and demographic benefits are measurable, and these are discussed in this section. For completeness, this section also provides a brief review of why measurable adverse impacts to employment, economics and demographics are not anticipated.

The Project will generate economic activity throughout the ROI during construction and O&M. The need for professional services throughout the Project lifecycle could result in an influx of workers seeking employment with the Project. Construction of the Project's various components will require construction labor and will support jobs in existing businesses that provide goods and services for construction including meeting the consumer needs of workers. The Project's construction phase will create numerous jobs including jobs for specialized construction workers, equipment operators, and construction laborers. Where feasible, local workers will be hired to meet labor needs for Project construction, O&M, and decommissioning.

Expected job creation from development of the offshore wind industry in the Northeast was recently described in the report, *U.S. Job Creation in Offshore Wind*, prepared for NYSERDA, which reflected collaboration with representatives of the Massachusetts Department of Energy Resources, the Massachusetts Clean Energy Center (MassCEC), and the Rhode Island Office of Energy Resources (BVG Associated Limited 2017). The report estimated economic benefits from the development of offshore wind farms off the US Northeast coastline from Maine to Maryland. The analysis used two market scenarios for the Northeast: a low scenario in which 4 GW is installed by 2030 and a high scenario in which 8 GW is installed by 2030. In the low scenario, this translates to 160,000 baseline full-time equivalent (FTE) job years over the lifetime of the wind farms, with a peak of 8,300 FTE jobs in 2028. In the high scenario, there would be a total of 320,000 baseline FTE job years, with a peak of 16,700 FTE jobs in 2028.

Project-specific estimates for job creation during construction and operations are described in Appendix W – *Economic Modeling Report*²¹, which is provided under confidential cover.

Beyond direct, indirect, and induced job creation, additional beneficial impacts to the local economy are anticipated through the creation of tax revenue, the demand for construction materials, and the increase in spending in general. In a report by MassCEC, the construction phase of the single reference 400-MW project was expected to result in approximately \$161.9 to \$208.3 million in direct economic output, \$87.1 to \$208.3 million in indirect economic output, and \$94.7 to \$133.5 million in induced economic output.

²¹ The Jobs and Economic Development Impact (JEDI) model does not currently include options for DC transmission cables, or deep water locations.

CONSTRUCTION AND OPERATIONS PLAN

Site Characterization and Assessment of Impacts – Socioeconomic Resources

In the O&M phase, the estimates were approximately \$3.7 to \$6.7 million in direct economic output, an additional \$31.9 to \$74.6 million in indirect economic output, and \$9.8 to \$19.9 million in induced economic output (MassCEC 2018).

The job opportunities, tax revenues, and increased spending associated with construction activities would be Project benefits without measurable adverse effects. Due to the short duration of construction activities, it is unlikely that non-local workers will relocate families to the area permanently to meet construction-related labor demands. In addition, during construction, housing for the offshore workforce will be available on some offshore vessels. Incremental indirect and induced jobs in supporting industries will largely be absorbed by the existing resident members of the labor force. Therefore, the Project's construction activities are not anticipated to have measurable effects on the availability or cost of housing, nor will construction activities have measurable impacts on demographics within the primary ROI.

While on a smaller scale than construction, the O&M phase will still create a number of new, permanent jobs including vessel operators and maintenance technicians. During the O&M phase of MassCEC's single reference 400-MW project, approximately 35 to 64 new direct jobs are expected to be created, alongside 129 to 303 new indirect jobs and 219 to 491 induced jobs (MassCEC 2018). Permanent jobs will be secured by a combination of existing ROI workforce members and non-local workers who will relocate families to the area permanently. The numbers of new resident-workers in any local municipality within the ROI would not be large enough to measurably affect labor or housing markets and would not measurably influence local demographics.

The Project is not anticipated to have an adverse impact on housing property values. Construction activities can be noisy and obtrusive, but they do not measurably influence property values, which are based on longer-term influences rather than a temporary condition. Locations where noise and traffic impacts are predicted already experience noise and traffic including from construction activities. The Project does not present any new or extreme conditions that could measurably alter market conditions and property values. Onshore portions of the Project will be developed in previously disturbed areas or existing ROWs, the WTGs will be located offshore, and the construction and O&M support facilities will be located in areas that already contain the requisite infrastructure and are designated for such uses. Hoen et al. (2013) analyzed housing prices from home sales occurring within 10 mi (16 km) of onshore wind facilities in nine US states and found no statistical evidence that home values were affected in the post-announcement/preconstruction or post-construction periods. The MassCEC also commissioned a report *Relationship between Wind Turbines and Residential Property Values in Massachusetts* (2014) to study if home values were affected by their proximity to onshore WTGs. The study analyzed 122,198 home sales occurring between 1998 and 2012 of homes located within 5 mi (8 km) of 41 Massachusetts wind turbines. Results of this study indicated that there were no effects to nearby home prices resulting from the development of a wind turbine in a community. Additionally, a 2017 study found that when placed more than 8 mi (7 nm; 13 km) from shore, there is a minimal effect on vacation rental values associated with offshore wind farms (Lutzeyer et al. 2017). A 2018 study also found that there was no impact on property values when the wind farm is located 5.6 mi (9 km) offshore (Jensen et al. 2018). Since the Project will be located more than 18.5 mi (29.8 km) from shore, impacts to property values will be unlikely.

CONSTRUCTION AND OPERATIONS PLAN

Site Characterization and Assessment of Impacts – Socioeconomic Resources

Visible infrastructure during construction (vessel traffic) or O&M (permanent structures such as WTGs) can have an adverse economic effect if the infrastructure is located within close proximity to businesses that are highly dependent upon an area's views and/or pristine setting. Potential impacts on visual resources are assessed in Section 4.5.1. Visibility of marine construction activities will generally be limited to those recreating or working offshore, which would not impact the overall population, economy, or employment within the ROI. Viewshed mapping demonstrated that, following construction, the WTGs have the potential to be visible from a relatively small portion of the VSA (Section 4.5.1) and would thus not adversely affect businesses that are highly dependent upon an affected area's views and/or pristine setting. Therefore, there would be no long-term adverse impacts on the local economies that are dependent on recreation and tourism. Similarly, the potential for impacts to property values from the marine components of the Project are limited by their distance from coastal residential properties and associated potential visibility, and, as such, the Project's visible infrastructure is not expected to have a measurable impact on property values.

The incremental marine vessel traffic associated with construction and O&M of the Project, or any noise or visual effects associated with this temporary and transient increase in vessel activity, will not be of a scale that would impede the operations of any businesses dependent upon vessel traffic for the transport of goods and services. Therefore, they would not be expected to have measurable adverse effects on employment, economics, or demographics within the ROI. Since, onshore activities related to construction and O&M of the SRWF will be confined to existing port facilities and will be consistent with the current transportation patterns and noise typically associated with the ports, these activities would have no measurable adverse effects to population, economics, or demographics. Potential economic effects on commercial fisheries are detailed in Section 4.7.4.

Overall, the Project is expected to provide numerous economic benefits, including the creation of permanent job opportunities, increased spending, and tax revenues, without measurable adverse effects to employment, economics, and demographics.

4.7.1.3 Proposed Environmental Protection Measures

Several environmental protection measures will serve to maximize Project benefits and avoid potential impacts to population, economy, employment, and housing and property values as follows:

- Where feasible, local workers will be hired to meet labor needs for Project construction, O&M, and decommissioning.
- The construction of the Landfall and ICW HDD is expected to occur outside the summer tourist season, which is generally between Memorial Day and Labor Day. The construction schedule for the remaining Onshore Facilities will be designed to minimize impacts to the local communities to the extent feasible.
- The Onshore Transmission Cable and Onshore Interconnection Cable will not include any overhead utility poles, thus minimizing potential impacts to adjacent properties.
- Screening will be implemented at the OnCS–DC to the extent feasible, to reduce potential visibility and noise.

CONSTRUCTION AND OPERATIONS PLAN

Site Characterization and Assessment of Impacts – Socioeconomic Resources

- Sunrise Wind will coordinate with local authorities and develop a Maintenance and Protection of Traffic (MPT) plan as part of the Project's Environmental Management and Construction Plan (EM&CP) to minimize potential traffic impacts during construction.
- Sunrise Wind will use ADLS or related means (e.g., dimming or shielding) to limit visual impact, pursuant to approval by the FAA and BOEM, commercial and technical feasibility at the time of FDR/FIR approval, and dialogue with stakeholders.

4.7.2 Public Services

This section describes the affected environment and potential effects from the construction and operation of the Project as they relate to public services. The description of the affected environment and assessment of potential impacts to Public Services were developed by reviewing municipal plans including Multi-Hazard Mitigation and Comprehensive Emergency Management Plans, and publicly available data from fire, emergency medical services (EMS), and law enforcement agencies. In addition, online data portals such as the American Hospital Directory and ArcGIS Mapper were used to locate specific facilities. A description of the Public Services in the Project Area is provided below, followed by an evaluation of potential Project-related impacts.

4.7.2.1 Affected Environment

This section summarizes public services for the communities potentially impacted by the construction, O&M, and decommissioning of the SRWF, SRWEC, and Onshore Facilities within the primary ROI. The summary here focuses on the hospitals, fire protection, law enforcement, and EMS that will support port operations, construction activities, and O&M activity in New York, Connecticut, Maryland, Massachusetts, New Jersey, Rhode Island, and Virginia.

The following multi-hazard mitigation plans, or strategies, were referenced to identify the public service providers for the region:

New York

- Public services for the Onshore Facilities in the Town of Brookhaven, including the OnCS–DC and associated infrastructure, are characterized in the *Suffolk County Comprehensive Emergency Management Plan* (Suffolk County Department of Fire Rescue and Emergency Services 2018).
- Public services for the Port of Coeymans port facility and the Port of Albany port facility are characterized in the Albany County *Multi-Jurisdictional Multi-Hazard Mitigation Plan* (Albany County Government 2018).
- Public services for port facilities in Brooklyn and/or Manhattan, New York City are characterized in the *NYC's Risk Landscape: A Guide to Hazard Mitigation* (NYC Emergency Management 2019).
- Public services for the Port of Montauk port facility are characterized in the *Suffolk County Comprehensive Emergency Management Plan* (Suffolk County Department of Fire Rescue and Emergency Services 2018) and will be further defined in a forthcoming *Town of East Hampton Hazard Mitigation Plan* (Town of East Hampton 2020).

CONSTRUCTION AND OPERATIONS PLAN

Site Characterization and Assessment of Impacts – Socioeconomic Resources

- Public services for the Port Jefferson port facility are characterized in the *Suffolk County Comprehensive Emergency Management Plan* (Suffolk County Department of Fire Rescue and Emergency Services 2018).

Connecticut

- Public services for the State Pier are characterized in the *Hazard Mitigation Plan Update Annex for the City of New London* (New London and Milone 2017).

Maryland

- Public services for the Sparrows Point port facility are characterized in *Emergency Operations for the County of Baltimore* (Baltimore County Government 2019).

Massachusetts

- Public services for the New Bedford Marine Commerce Terminal are characterized in the *Local Multi-Hazard Mitigation Plan Update for the City of New Bedford* (City of New Bedford 2016).

Rhode Island

- Public services for the Port of Providence facility are characterized in *Strategy for Reducing Risks from Natural, Human-Caused and Technologic Hazards in Providence, Rhode Island: A Multi-Hazard Mitigation Plan* (PLHMC and Horsley 2019).
- Public services for the Port of Davisville and Quonset Point port facility are characterized in *Strategy for Reducing Risks from Natural Hazards in North Kingstown, Rhode Island: A Multi-Hazard Mitigation Strategy 2013 – 5-Year Update*, which was developed with input from a stakeholder committee that included the Harbormaster and a member of the Quonset Development Corporation (North Kingstown and RIEMA 2013).
- Public services at Port of Galilee are characterized in *Strategy for Reducing Risks from Natural Hazards in Narragansett, Rhode Island: A Multi-Hazard Mitigation Strategy* (Town of Narragansett 2019).

New Jersey

- Public services for the Paulsboro Marine Terminal are characterized in Gloucester County New Jersey's *Multi-Jurisdictional Hazard Mitigation Plan* (Gloucester County Office of Emergency Management 2009) and *New Jersey State Hazard Mitigation Plan 2019* (State of New Jersey Office of Emergency Management 2019)

Virginia

- Public services for the Port of Norfolk port facility are characterized in *Hampton Roads Hazard Mitigation Plan* (Hampton Roads Planning District Commission 2017).

In addition to these public service providers, the USCG also provides public services in the maritime environment including maritime law enforcement, maritime response, and maritime security operations.

CONSTRUCTION AND OPERATIONS PLAN

Site Characterization and Assessment of Impacts – Socioeconomic Resources

Multiple hospitals serve the communities in the ROIs. Table 4.7.2-1 identifies those facilities either closest to Project construction and O&M activities or those serving as trauma centers for emergency response purposes (American Hospital Directory 2020). Most of the hospitals in the ROI have approximately 230 to 530 staffed beds. Fewer than 100 beds are available at South County Health near the Port of Galilee in the Town of Narragansett, RI (79 beds) and the Stony Brook Southampton Hospital, which services the Port of Montauk (94 beds). The greatest number of beds are provided to the Port of Providence, which is served by Rhode Island Hospital (691 beds) and the New Bedford Marine Commerce Terminal, which is served by Saint Luke's Hospital (867 beds; combined with the nearby Charlton Memorial Hospital in Fall River, MA for reporting purposes).

Table 4.7.2-1 Hospitals Closest to Project Construction and O&M Activities: Selected Statistics

Facilities Project Activity	Nearest Hospital	Address	Phone	Staffed Beds	Total Discharges
Onshore Facilities					
Onshore Transmission Cable and OnCS–DC, Town of Brookhaven, NY	Brookhaven Memorial Hospital	101 Hospital Road Patchogue, NY 11772	631-654-7100	235	11,756
Potential Port Facilities					
Port of Coeymans, NY and Port of Albany, NY	Saint Peters Hospital	315 South Manning Boulevard, Albany NY 12208	518-525-1550	482	27,097
Port of Montauk, NY	Stony Brook Southampton Hospital	240 Meefing House Lane Southampton, NY 11968	631-726-8200	94	4,318
Port Jefferson, NY	Saint Charles Hospital	200 Belle Terre Road Port Jefferson, NY 11777	631-474-6000	243	9,315
Port of Brooklyn, Kings County, NY	NYU Langone Hospital - Brooklyn	150 55 th Street Brooklyn	718-630-7000	388	23,168
Port of New York, Manhattan, NY	TBD				
Port of New London, New London, CT	Lawrence and Memorial Hospital	365 Montauk Avenue New London, CT 06320	860-442-0711	252	13,022
New Bedford Marine Commerce Terminal, New Bedford, MA	Saint Luke's Hospital/Charlton Memorial Hospital	101 Page Street New Bedford, MA 02740/363 Highland Avenue Fall River, MA 02720	508-997-1515/508-679-3131	867 ^{/a}	32,582 ¹
Sparrows Point, MD	Johns Hopkins Bayview Medical Center	4940 Eastern Avenue Baltimore, MD 21224	410-550-0100	411	19,138
Paulsboro Marine Terminal, Paulsboro, NJ	Inspira Medical Center Woodbury	509 North Broad Street Woodbury, NJ 08096	856-845-0100	253	8,125
Port of Galilee, Narragansett, RI	South County Health	100 Kenyon Avenue Wakefield, RI 02879	401-782-8000	79	5,804

CONSTRUCTION AND OPERATIONS PLAN

Site Characterization and Assessment of Impacts – Socioeconomic Resources

Facilities Project Activity	Nearest Hospital	Address	Phone	Staffed Beds	Total Discharges
Port of Davisville and Quonset Point, North Kingstown, RI	Kent Hospital	455 Tollgate Road Warwick, RI 02886	401-737-7000	343	14,196
Port of Providence, Providence, RI	Rhode Island Hospital	593 Eddy Street Providence, RI 02903	401-444-4000	691	30,561
Norfolk VA	Sentara Norfolk General Hospital	600 Gresham Drive Norfolk, VA 23510	757-388-3000	527	24,099
SOURCE: American Hospital Directory 2020 NOTE: /a Statistics for Saint Luke's Hospital are combined with statistics for Charlton Memorial Hospital in Fall River, MA.					

Fire, EMS, and law enforcement services specific to the potential construction and O&M activities at potential ports are summarized in Table 4.7.2-2.

The Suffolk County Police Department serves five of the 10 towns on Long Island and provides law enforcement to the Village of Port Jefferson (Suffolk County Police Department 6th Precinct) and to the Town of Brookhaven (Suffolk County Police Department 5th, 6th and 7th Precinct). The Suffolk County Police Department has a total size of approximately 2,350 police officers of all rank. In addition, there are several fire, EMS, and law enforcement services in the vicinity of the Onshore Facilities. For a list of these services, see Table 4.7.2-2.

The Coeymans Volunteer Fire Department provides fire safety services for the Town of Coeymans. The Ravena Rescue Squad services approximately 70 mi² of both Albany and Greene County and provides EMS services to the Port of Coeymans. The Coeymans Police Department provides law enforcement services and is comprised of approximately 25 police officers of various ranks.

The Albany Fire Department and EMS provides fire safety and EMS support to Albany County. The Albany Department of Fire and Emergency Services consists of 260 career Firefighters staffing eight engine companies (including one paramedic engine company), four ladder companies, three paramedic rescue companies, one heavy rescue company, two battalions and administrative staff. In addition, the Albany County Sherriff's Office provides EMS support to Albany County. Both the Albany County Police Department, and Albany County Sherriff provide law enforcement services.

In New York City, the New York City Fire Department (FDNY) provides both fire and EMS support to all of New York City. The FDNY employs approximately 10,951 uniformed firefighters, 4,301 uniformed emergency medical technicians (EMTs) and 59 paramedics, and 2,096 civilian employees. With approximately 36,000 officers and 19,000 civilian employees, the New York Police Department (NYPD) provides law enforcement and safety to New York City.

In Montauk, the Montauk Fire Department has 118 members, 24 of whom are part of the EMS Company. The East Hampton Town Police Department/Montauk Precinct provides law enforcement. The East Hampton Town Police Department is staffed with 63 sworn police officers serving in patrol, detectives, supervisory, administrative, and various specialized unit roles.

CONSTRUCTION AND OPERATIONS PLAN

Site Characterization and Assessment of Impacts – Socioeconomic Resources

In Port Jefferson, the Village of Port Jefferson Fire Department is charged with providing service to the Village and is composed of five companies and approximately 105 personnel. The Port Jefferson Volunteer Ambulance Corps operates with 67 career/volunteer paramedics and EMTs based out of one station. The service operates three-Advanced Life Support (ALS) ambulances, one-24/7 career paramedic responder, one-ALS volunteer first responder, and three ALS EMS chief vehicles across a 16-mi² area of Suffolk County.

For the New London State Pier in New London, CT, port security is the responsibility of the facility operator (managed by Gateway Terminal, formerly managed by Logistec [Turmelle 2019]) and is facilitated by a security plan meeting *Maritime Transportation Security Act* requirements (Connecticut and Milone 2015). The New London Fire and Police Departments provide emergency response services.

For the New Bedford Marine Commerce Terminal, the City of New Bedford, MA is responsible for all fire, EMS, and law enforcement.

For the Paulsboro Marine Terminal, the Township of Paulsboro, NJ is responsible for both fire and law enforcement, and Gloucester County EMS Basic Life Support (BLS) 16 provides EMS services to the area.

For the port at Sparrows Point, MD, fire, EMS services, and law enforcement are all provided by Baltimore County. Baltimore County Fire Department – Sparrows Point – Station 57 is responsible for both fire and EMS Services, and Baltimore County Police Department – Precinct 12 is responsible for law enforcement.

For the Rhode Island ports, at the Port of Galilee, emergency services are provided by Narragansett Fire Department – Station 2, while the Narragansett Police Department provides law enforcement services. Fire and EMS services for the Port of Davisville and Quonset Point are provided by the Town of North Kingstown. The North Kingstown Police Department is responsible for police and law enforcement (North Kingstown Police Department 2019). The Port of Providence is operated by Waterson Terminal Services (WTS), which is responsible for general management and safety. Because it is a maritime port, WTS has a security plan for the Port of Providence with detailed procedures, while the Providence Fire Department and Police Department provide emergency response services (WTS 2019).

For the Port of Norfolk in Virginia, fire and EMS services are provided by the Norfolk Fire Rescue. In addition, Navy Region Mid-Atlantic Fire & Emergency Services Station 4 provides additional fire service support to the area. Law enforcement is provided by the Virginia Port Authority Police Department.

CONSTRUCTION AND OPERATIONS PLAN

Site Characterization and Assessment of Impacts – Socioeconomic Resources

Table 4.7.2-2 Fire, EMS, and Law Enforcement Services at Onshore Locations Potentially Supporting Construction, Operations, and Maintenance Activities

Onshore Location	Location	Provider of Fire Services	Provider of EMS Services	Provider of Law Enforcement Services/Police
Onshore Facilities				
Onshore Transmission Cable, Onshore Interconnection Cable and OnCS–DC, Town of Brookhaven, NY	Town of Brookhaven, NY	Brookhaven Fire Department	South Country Ambulance	Suffolk County Police – 5th, 6th, and 7th Precinct
	Shirley, NY	Brookhaven Fire Department and Mastic Fire Department	Shirley Community Ambulance	Suffolk County Police – 7th Precinct
	Yaphank, NY	Yaphank Fire Department	Yaphank Fire Department	Suffolk County Police – 5th, 6th, and 7th Precinct
	Medford, NY	Medford Fire Department	Medford Volunteer Ambulance	Suffolk County Police – 5th and 6th Precinct
	Holtsville, NY	Holtsville Fire Department	Holtsville Fire Department	Suffolk County Police – 5th and 6th Precinct
	Farmingville, NY	Farmingville Fire Department	Farmingville Fire Department (and Rescue Squad)	Suffolk County Police – 5th and 6th Precinct
	Holbrook, NY	Holbrook Fire Department	Holbrook Fire Department (and Medic Company)	Suffolk County Police – 5th, 6th, and 7th Precinct
Potential Port Facilities				
Port of Albany	Albany, NY	Albany Fire Department & EMS	Albany Fire Department & EMS and Albany County Sheriff's Office	Albany Police Department and Albany County Sheriff
Port of Coeymans	Town of Coeymans, NY	Coeymans Volunteer Fire Department	Ravena Rescue Squad	Coeymans Police Department
Port of Montauk	Town of East Hampton, NY	Montauk Fire Department	Montauk Fire Department	East Hampton Town Police Department – Montauk Precinct
Port Jefferson, NY	Village of Port Jefferson, NY	Port Jefferson Fire Department	Port Jefferson EMS	Suffolk County Police – 6th Precinct
Port of Brooklyn	Kings County, NYC	Fire Department of the City of New York	Fire Department of the City of New York EMS Team	New York Police Department
Port of New York	New York County, NYC	Fire Department of the City of New York	Fire Department of the City of New York EMS Team	New York Police Department
Port of New London, CT	New London, CT	New London Fire Department, North Station	New London Fire Department	New London Police Department
Sparrows Point, MD	Baltimore County, MD	Baltimore County Fire Department -Sparrows Point - Station 57	Baltimore County Fire Department – Sparrows Point - Station 57	Baltimore County Police Department – Precinct 12

CONSTRUCTION AND OPERATIONS PLAN

Site Characterization and Assessment of Impacts – Socioeconomic Resources

Onshore Location	Location	Provider of Fire Services	Provider of EMS Services	Provider of Law Enforcement Services/Police
New Bedford Marine Commerce Terminal, MA	New Bedford, MA	New Bedford Fire Department	New Bedford EMS	New Bedford Police Department
Paulsboro Marine Terminal, NJ	Paulsboro, NJ	Paulsboro Fire Department	Gloucester County EMS BLS 16	Paulsboro Police Department
Port of Galilee, RI	Narragansett, RI	Narragansett Fire Department, Port Judith Station/Station 2	Narragansett Fire Department	Narragansett Police Department
Port of Providence, RI	Providence, RI	Providence Fire Department, Broad Street Station	Providence Fire/EMS	Providence Police Department
Port of Davisville and Quonset Point, RI	North Kingstown, RI	North Kingstown Fire Department, Station 6	North Kingstown Fire Department	North Kingstown Police Department
Port of Norfolk, VA	City of Norfolk, VA	Norfolk Fire-Rescue, Navy Region Mid-Atlantic Fire & Emergency Services Station 4	Norfolk Fire-Rescue	Virginia Port Authority Police Department

4.7.2.2 Potential Impacts

This section considers whether construction and O&M activities associated with the SRWF, SRWEC, and Onshore Facilities could have adverse effects on public services. A project can have a direct impact on public services if it physically alters a community/public facility in such a way that service delivery of the affected facility is adversely affected. Impacts can either be permanent (e.g., displacement of a facility) or temporary (e.g., closure during construction activities). A project can also have an indirect effect on public services if it induces an increase in population size such that there is an increased demand for existing services and a resulting adverse impact to service delivery, or if there are potential traffic impacts that would impede service delivery.

CONSTRUCTION AND OPERATIONS PLAN

Site Characterization and Assessment of Impacts – Socioeconomic Resources

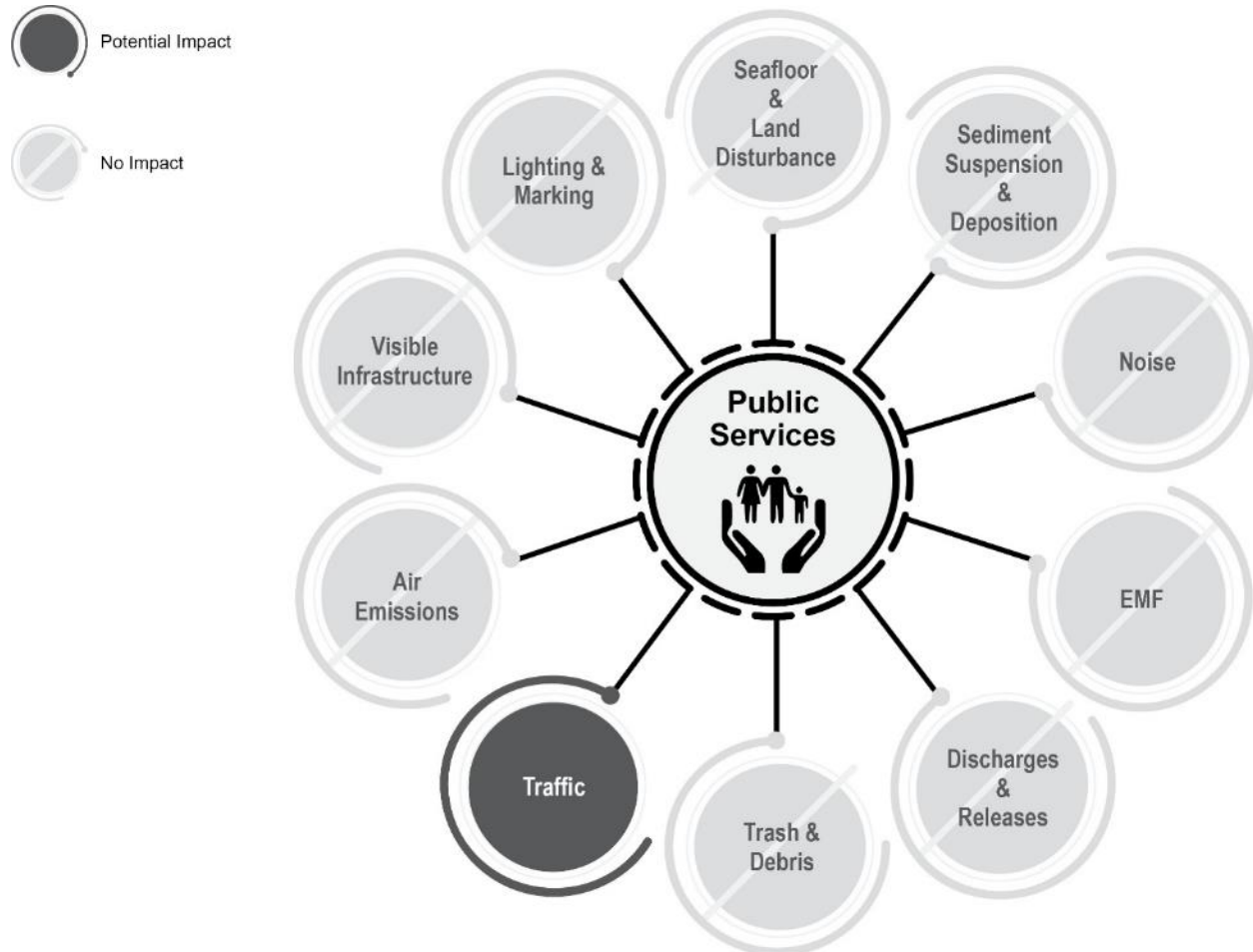

Figure 4.7.2-1 Impact-Producing Factors on Public Services

As depicted in Figure 4.7.2-1, during construction of the SRWF and SRWEC, traffic is the only IPF with the potential to affect the level of public services provided in the region. Public services are already available at each of the potential port facilities, most non-local workers will be housed in short-term accommodations onboard vessels located offshore, and any traffic disruptions would be minor. The needs of these staff would be limited relative to the overall demand for public services within each county, and the increase is not expected to generate the need for additional public services in the region nor to interrupt existing services. During O&M of the SRWF and SRWEC, effects on public services are also expected to be temporary and limited as a result of potential temporary traffic disruptions and minor increase in demand for law enforcement and other emergency services by the workforce responsible for O&M of the Project.

The need for public services during either construction or O&M of the SRWF or SRWEC is expected to be infrequent and would add minimal additional burden to existing public services.

CONSTRUCTION AND OPERATIONS PLAN

Site Characterization and Assessment of Impacts – Socioeconomic Resources

Onshore Facilities

Construction

Traffic

Construction of Onshore Facilities will occur along existing transportation corridors, requiring temporary isolated and/or partial road closures that may result in potential traffic delays, congestion, and narrow roadways. These impacts would be localized and temporary. Transportation of construction equipment and materials for the Project will not block or significantly slow traffic on major roadways for long periods of time. Roadways will not be blocked to local vehicular traffic for extended periods of time.

During construction of the Onshore Facilities, there would be a short-term negligible increase in traffic due to truck and construction equipment and from a limited number of non-local workers. The increase in any construction traffic would be comparable to typical roadway or utility construction work. Local police would likely be needed to control traffic through temporary detours and lane or road closures and to be present during construction activities. However, vehicular traffic volumes and frequencies during construction are not expected to have a measurable impact on public services in and around the Onshore Facilities as any traffic increases would be minor. As required by New York State Law, Sunrise Wind will develop a Maintenance and Protection of Traffic (MPT) plan within the Project's EM&CP that describes measures to minimize and mitigate for potential impacts during construction.

Operations and Maintenance

Traffic

Because the Onshore Transmission Cable and Onshore Interconnection Cable will be installed entirely underground, it is not anticipated that operation of the Onshore Facilities will have measurable adverse impacts on local traffic during operations. The Onshore Transmission Cable and Onshore Interconnection Cable will require little maintenance; these components are designed such that inspection and maintenance during operations occurs infrequently (typical maintenance cycle requires access to the vaults one time every five years) unless a fault or failure occurs. In the unlikely event of such a case, Sunrise would coordinate with public service entities in the Town of Brookhaven.

The OnCS–DC will be unmanned during routine operations and will be inspected regularly based on manufacturer-recommended schedules. Personnel will be on site as necessary for any maintenance or repairs but are not expected to affect the need for public services in the vicinity of the Onshore Facilities.

4.7.2.3 Proposed Environmental Protection Measures

Several environmental protection measures will reduce potential impacts to public services.

- The construction of the Landfall and ICW HDD is expected to occur outside the summer tourist season, which is generally between Memorial Day and Labor Day. The construction schedule for the remaining Onshore Facilities will be designed to minimize impacts to the local communities to the extent feasible.

CONSTRUCTION AND OPERATIONS PLAN

Site Characterization and Assessment of Impacts – Socioeconomic Resources

- Sunrise Wind will coordinate with local authorities and develop an MPT plan as part of the Project's EM&CP to minimize potential traffic impacts during construction.
- A comprehensive communication plan will be implemented during offshore construction to inform all mariners, including commercial and recreational fishing vessels, and recreational boaters, of construction activities and Project-related vessel movements. Communication will be facilitated through a Project website, public notices to mariners and vessel float plans, and a Fisheries Liaison. Sunrise Wind will submit information to the USCG to issue Local Notice to Mariners during offshore installation activities.

4.7.3 Recreation and Tourism

This section describes the affected environment and potential effects related to recreation and tourism from the construction and operation of the Project. The description of the affected environment and assessment of potential impacts to recreation and tourism were developed by reviewing the current related public data sources including state and federal agency-published papers and databases, online data portals and mapping databases (e.g., state coastal management programs and plans), environmental studies, and published scientific literature relating to the tourism industry and both onshore and offshore recreational activities in the affected area. A description of the recreation and tourism industries in the Project Area is provided below, followed by an evaluation of potential Project-related impacts.

4.7.3.1 Affected Environment

This section describes existing recreation and tourism opportunities including both onshore activities, such as beach visitation and wildlife viewing, and offshore activities from, or on, a boat within the expanded ROI (Suffolk County, NY; New London County, CT; Barnstable County, MA; Bristol County, MA; Dukes County, MA; Nantucket County, MA; Plymouth County, MA; Kent County RI; Newport County, RI; Providence County, RI; and Washington County, RI [see Table 4.7.1 and Figure 4.5.1-2]). The value of tourism among the counties within the expanded ROI is sizable and is often a critical component of local economies.

Data that support this section largely derive from BOEM's Atlantic Region Wind Energy Development: Recreation and Tourism Economic Baseline Development: Impacts of Offshore Wind on Tourism and Recreation Economies report, which identified the coastal areas (i.e., counties) for each WEA by their potential to encounter both beneficial and detrimental socioeconomic effects from each phase (planning, construction, and decommissioning) of wind facility development (ICF 2012). All counties within the expanded ROI were included in BOEM's assessment.

Regional Overview

The expanded ROI represents a broad area; therefore, the following discussions describe the affected environment as it relates to offshore recreation and tourism and onshore recreation and tourism, as these are relevant to the SRWF, SRWEC, and Onshore Facilities.

CONSTRUCTION AND OPERATIONS PLAN

Site Characterization and Assessment of Impacts – Socioeconomic Resources

Offshore Recreation and Tourism

As described in Table 4.7.3-1 below, offshore recreation and tourism activities within the expanded ROI include swimming, snorkeling, surfing, kayaking, boating and boat-fishing, sailing, parasailing, yachting, and harbor cruises (ICF 2012). Activities that occur further offshore in the vicinity of the SRWF include recreational boating, sailboat racing, yachting, scuba diving, and offshore wildlife viewing (e.g., whale, shark, and bird watching). Offshore recreation in the vicinity of the SRWF are described in the NYS Coastal Management Program (NYS CMP), the NYSERD) Offshore Wind Master Plan: Marine Recreational Uses Study, the Rhode Island Ocean Special Area Management Plan (OSAMP), the 2012 Northeast Recreational Boater Survey, and the Ocean Planning in the Northeast report (Bloeser et al. 2015; NYSDOS 2017; NYSERDA 2017; RI CRMC 2010; SeaPlan 2013;). The Northeast Regional Ocean Council maintains Northeast Ocean Data, which is an online interactive map that includes offshore recreation and tourism locations and routes compiled from the 2013 Northeast Recreational Boater Survey and SeaPlan, Surfrider, and Point 97 (NROC 2014; SeaPlan 2013, 2015b).

Recreational boating and fishing are significant recreational activities in the coastal waters of New York State. Recreational angling in New York generates \$369 million in sales, which translates to \$212 million gross domestic state product (NYS 2017) ²². A boating survey by Cornell University indicated the marina industry on Long Island grosses \$55 million annually (NYSDOS 2017) ²³.

The 2012 Northeast Recreational Boater Survey characterized the boating patterns and economic activity of the 373,766 qualified registered boaters from coastal counties and towns in New York, Connecticut, Maine, Massachusetts, New Hampshire, and Rhode Island and included maps from the survey of 5,114 boating routes and 4,635 activity points (SeaPlan 2013). The survey estimated there were approximately 907,400 boating trips in ocean and coastal waters during 2012 for the registered and documented marine boaters of the six Northeast states. Most of these trips, or 90.1 percent, were made by vessels registered in one of the four states in the expanded ROI. Of the 817,368 estimated boating trips in the 2012 *Northeast Recreational Boater Survey* study area, 42.5 percent were made by vessels registered in New York, 15.6 percent in Connecticut, 32.1 percent in Massachusetts, and 8.0 percent in Rhode Island (SeaPlan 2013). Over half (52 percent) of boating trips documented by SeaPlan (2013) occurred within 1 mi (1.6 km) of the coastline, with higher levels of boating activity occurring in semi-protected bays and harbors near major cities such as Narragansett Bay (SeaPlan 2013).

The OSAMP provides offshore recreational maps of the Rhode Island Sound and Block Island Sound based on stakeholder feedback, USCG event permits, and racing event instructions (RI CRMC 2010). Rhode Island Sound and adjacent waters provide a wide range of marine recreation and tourism opportunities (Table 4.7.3-1). Specifically, these waters are used for a variety of boat-based activities such as recreational boating, offshore sailboat racing, offshore diving, and offshore wildlife viewing. The Rhode Island Sound experiences a substantial amount of activity of which sailing is only one component.

²² Recreational Angling and Shellfishing are discussed further in Section 4.7.4

²³ Sea Grant Advisory Service, Cornell University, Ongoing Research of Recreational Boating on the Shoreline of Westchester County, New York City and Long Island, Ithaca, NY, 1974.

CONSTRUCTION AND OPERATIONS PLAN

Site Characterization and Assessment of Impacts – Socioeconomic Resources

According to data from the Northeast Boater Survey (SeaPlan 2013), numerous recreational boater routes either transect, or are near, the SRWF and SRWEC. Recreational boating routes and recreational boating density are presented in Figure 4.7.3-1.

Table 4.7.3-2 provides a characterization of the sailboat, distance, and buoy races that generally occur in the vicinity of the SRWF and SRWEC. Most of the races occur from May to September and have fewer than 100 participants. The largest event is the Newport to Bermuda Yacht Race, which occurs in June and can have over 250 participants. The Off Soundings Club Spring Race Series often hosts up to 150 participants at its event in June off Block Island (ICF 2012). The New York Yacht Club hosts multiple large race events each year including its Annual Regatta, Race Week, and an Annual Cruise.

This page intentionally left blank

V:\1956\active_Task Owner and other Non-BC\1956_jobs\20281131\19903_data\gis_cad\gis\mxd\COP\20281131\199_4.7.3-1_RecBoating.mxd Revised: 2020-12-07 By: hturner

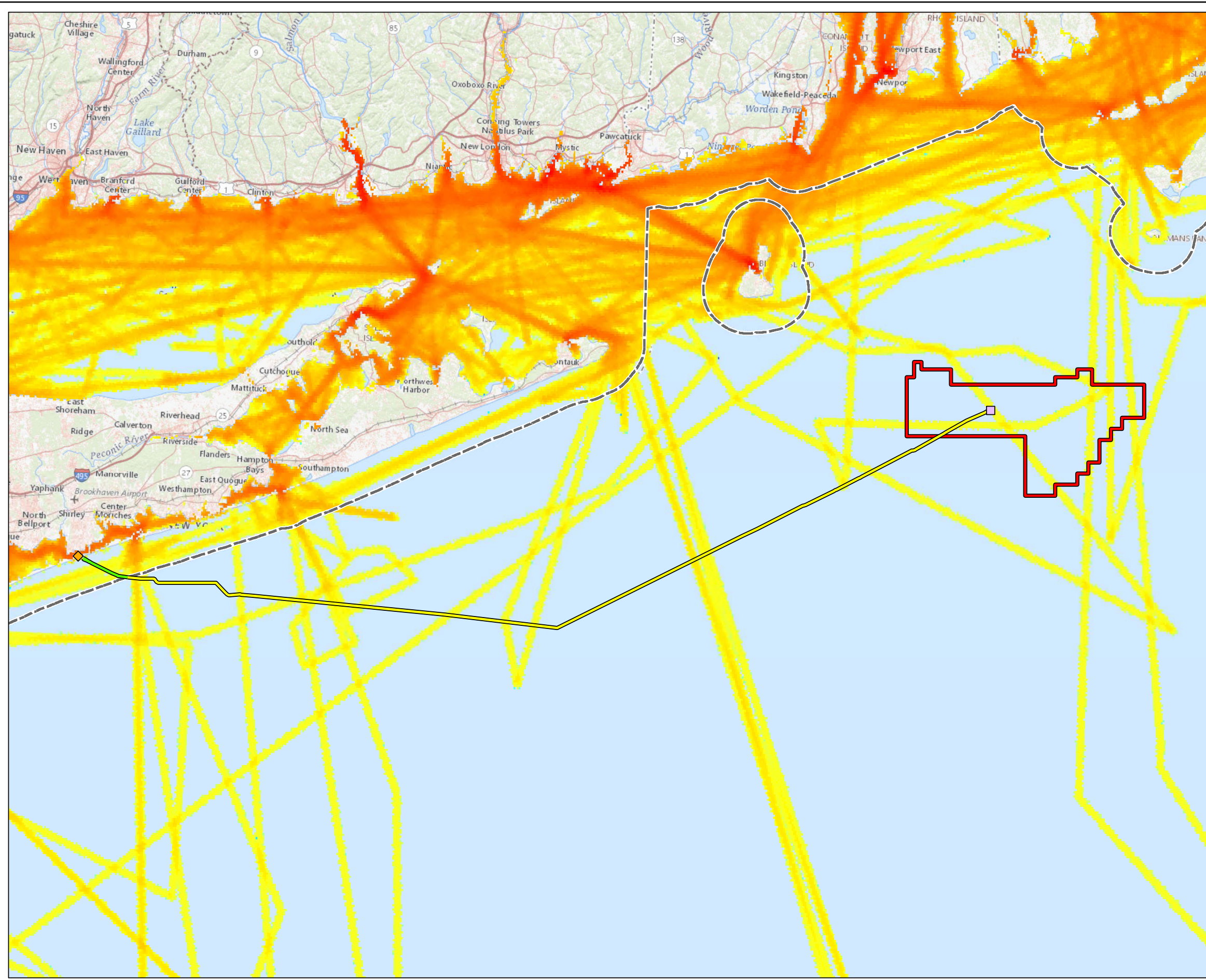

**Figure 4.7.3-1
Recreational Boating Routes and
Recreational Boating Density**

Sunrise Wind | Powered by Ørsted & Eversource

Legend

- Sunrise Wind Farm (SRWF)
- Offshore Converter Station (OCS-DC)
- ◆ SRWEC Landfall Location
- Sunrise Wind Export Cable (SRWEC-OCS)
- Sunrise Wind Export Cable (SRWEC-NYS)
- 3-nm State Waters Boundary

Recreational Boating Density

Note: Due to map scale, not all density color may be visible.

Sources
SeaPlan 2012 Northeast Recreational Boater Survey as provided by the Northeast Regional Ocean Council and NortheastOceanData.org

Date	09/01/2020 Revised: 12/18/2020
Project Number	2028113199
Prepared By	GC
Reviewed By	LJ

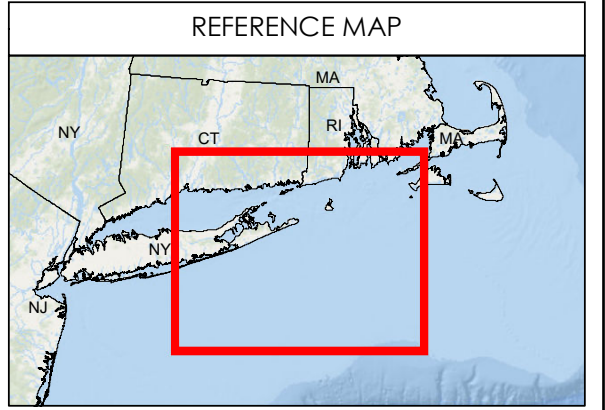
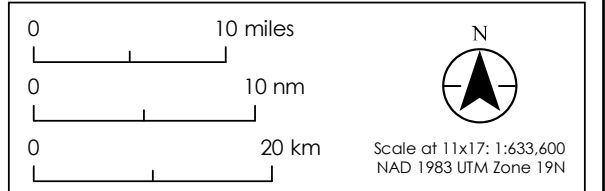

This page intentionally left blank

CONSTRUCTION AND OPERATIONS PLAN

Site Characterization and Assessment of Impacts – Socioeconomic Resources

Table 4.7.3-1 Sailboat, Distance, and Buoy Races in or Near Rhode Island Sound and Block Island Sound

Event	Organizer	Month	Frequency	Course Description	Avg. No. of Vessels	Avg. Vessel Length (ft/m)
New York						
New York Yacht Club Annual Regatta	New York Yacht Club	June	Annual	Buoy races south of Brenton Point	110	30-90/9-27
New York Yacht Club Invitational Cup	New York Yacht Club	Sept	Biennial	Buoy races south of Brenton Point	20	42/12.8
New York Yacht Club Race Week	New York Yacht Club	Sept	Biennial	Buoy races south of Brenton Point	150	30-90/9-27
Swan 42 National Championship	New York Yacht Club	July	Annual	Buoy races south of Brenton Point	20	42/12.8
New York Yacht Club Annual Cruise	New York Yacht Club	August	Annual	Varies	100	30-90/9.1-27.4
Connecticut						
Block Island Race ^{c/}	Storm Trysail Club	May	Annual	Stamford, CT around Block Island and back to Stamford	60	30-75/9.1-22.8
Corinthians Stonington to Boothbay Harbor Race ^{c/}	Corinthians Association, Stonington Harbor Yacht Club, and Boothbay Harbor Yacht Club	July	Biennial	Stonington, CT to Boothbay, ME	14	N/A
Stamford Vineyard Race ^{e/}	Stamford Yacht Club	Aug/Sept	Annual	Stamford, CT to entrance of Vineyard Sound and back to Stamford	77	30-90/9.1-27.4
Massachusetts						
Marion to Bermuda Cruising Yacht Race ^{c/}	Marion-Bermuda Cruising Yacht Race Association	June	Biennial	Marion, MA to Bermuda	48	32-80/9.7-24.3
Whaler's Race	New Bedford Yacht Club	Sept	Annual	City of New Bedford, around Block Island, to Noman's Island, and back to New Bedford	22	25+/7.6+

CONSTRUCTION AND OPERATIONS PLAN

Site Characterization and Assessment of Impacts – Socioeconomic Resources

Event	Organizer	Month	Frequency	Course Description	Avg. No. of Vessels	Avg. Vessel Length (ft/m)
Rhode Island						
Block Island Race Week ^a	Storm Trysail Club (odd years); Ted Zuse (even years)	June	Annual	Week of buoy races west of Block Island	100+	30-90/9-27
Sail Newport Coastal Living Newport Regatta	Sail Newport	July	Annual	Buoy races south of Brenton Point	Varies	Varies
World championship regattas (vary) ^{b/}	Various	Sept	Annual	Buoy races south of Brenton Point	Varies	Varies
Annapolis to Newport Race ^{c/}	Annapolis Yacht Club	June	Biennial	Annapolis, MD to Newport	61	34+/10.3+
Bermuda One-Two ^{c/}	Goat Island Yacht Club and Newport Yacht Club	June	Biennial	Singlehanded (one crew member): Newport to Bermuda; Doublehanded (two crew members): Bermuda to Newport	38	28-60/8.5-18.2
Earl Mitchell Regatta	Newport Yacht Club	Oct	Annual	Newport to Block Island	15	30-50/ 9.1-15.2
Ida Lewis Yacht Club Distance Race	Ida Lewis Yacht Club	August	Annual	Multi-legged course through Rhode Island Sound and adjacent offshore waters	40	30-90/ 9.1-27.4
New England Solo-Twin Championships	Newport Yacht Club and Goat Island Yacht Club	July	Annual	Multi-legged course through Rhode Island Sound and adjacent offshore waters; starts and ends in Newport	35	24-60/ 7.3-18.2
Newport Bucket Regatta	Bucket Regatta/Newport Shipyard	July	Annual	Three multi-legged course off Brenton Point	19	68-147/20.7-44.8
Newport to Bermuda Race	Cruising Club of America	June	Biennial	Newport to Bermuda	265	30-90/9.1-27.4
Offshore 160 Single-Handed Challenge	Newport Yacht Club and Goat Island Yacht Club	July	Biennial	Multi-legged course through Rhode Island Sound and adjacent offshore waters; starts and ends in Newport	15	28-60/8.5-18.2
Off Soundings Club Spring Race Series	Off Soundings Club	June	Annual	Day 1: Watch Hill to Block Island Day 2: Around Block Island	120-150	23-62/7-18.8

CONSTRUCTION AND OPERATIONS PLAN

Site Characterization and Assessment of Impacts – Socioeconomic Resources

Event	Organizer	Month	Frequency	Course Description	Avg. No. of Vessels	Avg. Vessel Length (ft/m)
Owen Mitchell Regatta	Newport Yacht Club	May	Annual	Newport to Block Island	31	24-44/7.3-13
Volvo Ocean Race ^{a/}	N/A	Oct - June	Triennial	Alicante, Spain to Gothenburg, Sweden with a stopover in Newport	N/A	N/A

Source: RI CRMC 2010; SeaPlan 2015a

NOTES: Races start and/or end in Newport unless otherwise noted.

^{a/} Event may also include one around-the-island race.

^{b/} The Newport sailing community hosts at least one "world championship" regatta each September. In Meter World Cup and the Twelve Meter World Championships.

^{c/} Major sailboat races depicted on Figure 4.7.3-1. Route data are unavailable for other sailboat races.

In addition to Table 4.7.3-1 above, Appendix H of the *Ocean Planning in the Northeast* report includes a list of known sailing event organizers and events. Additional sailboat races in New York that generally occur in the vicinity of the expanded ROI have been included in Table 4.7.3-2 below. Races such as the Fishers Island Yacht Club Round Island Race and the Long Island Sound IRC/PHRF Championships draw between 100 and 500 participants. Smaller races such as the Storm Trysail Foundation/Fishers Island Yacht Club Junior Overnight Race draw between 50 and 100 participants and larger races such as the Jr. Safety as Sea race can draw between 500 and 1,000 participants (Bloeser et al. 2015).

Table 4.7.3-2 Sailboat, Distance, and Buoy Races in or Near Long Island Bays and the Atlantic Ocean

Organization	City/State	Races	Month
Bellport Bay Yacht Club	Bellport, NY	Bellport Bay Yacht Club Sandwich Series	not documented in source
		Bellport Bay Yacht Club Junior Regatta	not documented in source
		Bellport Bay Yacht Club Labor Day NOR	not documented in source
		Bellport Bay Yacht Club Queen of the Bay NOR	not documented in source
		Bellport Bay Yacht Club PHRF Lite NOR	not documented in source
Breakwater Yacht Club	Sag Harbor, NY	BYC May Cup Series	May /b
		BYC Summer Series	June-September /b
		NYC Race Week	June /a
		Block Island Race Week	June /a
		Sag Harbor Cup	August /a
		BYC Race to Montauk	September /a
		BYC Wood Regatta	September /a
		BYC Fall Series	September-October /b
		BYC Last Rots	October /a

CONSTRUCTION AND OPERATIONS PLAN

Site Characterization and Assessment of Impacts – Socioeconomic Resources

Organization	City/State	Races	Month
Devon Yacht Club	Amagansett, NY	District 8 Laser Regatta	August
		PGJSA Qualifier and Devon Invitational for Sunfish and Laser	August
		PGJSA Regatta	August
		Round Gardiner's Island Race	August
Fishers Island Yacht Club	Fishers Island, NY	Storm Trysail Foundation/Fishers Island Yacht Club Junior Overnight Race	not documented in source
		Fishers Island Yacht Club Round Island Race	September /a
Mattituck Yacht Club	Mattituck, NY	Carol Smith Regatta	not documented in source
		Mattituck 420, Laser, Sunfish Regatta/PGJSA Qualifier	not documented in source
		Sail to the Dunes	not documented in source
Orient Yacht Club	Orient, NY	Thursday Night Series	June-September /b
		Spindrift Race	July
		c420 Regatta	July /a
Sag Harbor Yacht Club	Sag Harbor, NY	Maycroft Cup Regatta	September
Sayville Yacht Club	Bayport, NY	Leukemia Cup Regatta	August /a
		Charity Distance Race	not documented in source
		Laser District 8 Grand Prix NOR	not documented in source
		JY 15 North Americans NOR	not documented in source
Shelter Island Yacht Club	Shelter Island, NY	Shennecossett Pre-OSC Race, Around the Lighthouses	not documented in source
Shinnecock Yacht Club	Quogue, NY	Connett Bowl	August
		Celebrity Open Race	August
Southampton Yacht Club	Southampton, NY	Lightning 4th of July Cup	July
		Labor Day Cup	September
		Town Regatta	August
Southold Yacht Club	Southold, NY	Monday Night Series	May–August
		Carol Smith Regatta	not documented in source
Storm Trysail Club	Larchmont, NY	Around Block Island Race	May
		Storm Trysail Foundation/Fishers Island Yacht Club Junior Overnight Race	July
		Long Island Sound IRC/PHRF Championships	September a/
		Jr Safety at Sea	October
<p>SOURCE: Bloeser et al. 2015</p> <p>NOTES:</p> <p>a/ once per year recurrence;</p> <p>b/ once per week recurrence;</p>			

CONSTRUCTION AND OPERATIONS PLAN

Site Characterization and Assessment of Impacts – Socioeconomic Resources

NYSERDA's *Offshore Wind Master Plan-Marine Recreational Uses Study* identifies categories of marine recreational use, some of which include wildlife viewing (e.g., bird watching and whale watching), underwater activities (e.g., scuba diving), surface water activities (e.g., kayaking), and cruise ship tourism (NYSERDA 2017).

Offshore wildlife viewing in the region includes whale watching (peak season in June through August), shark cage diving (June through October), and bird watching (year-round but particularly after storm events). A dominant commercial whale watching area exists in the waters between Block Island and Montauk. However, the general whale watching area is larger and extends from the waters south of Napeague State Park (Suffolk County, NY) to east of Block Island (Washington County, RI) (NROC 2014; NYSERDA 2017; RI CRMC 2010). Within the general whale watching area, there are whale, shark, and bird watching locations as identified by the OSAMP (NYSERDA 2017; RI CRMC 2010). Figure 4.7.3-2 depicts wildlife viewing areas near the SWRF and SWREC.

This page intentionally left blank

V:\1956\active\Task Owner and other Non-BC\1956 Jobs\20281131\199_4.7.3-2_Wildlife View.mxd Revised: 2020-12-07 By: hurner

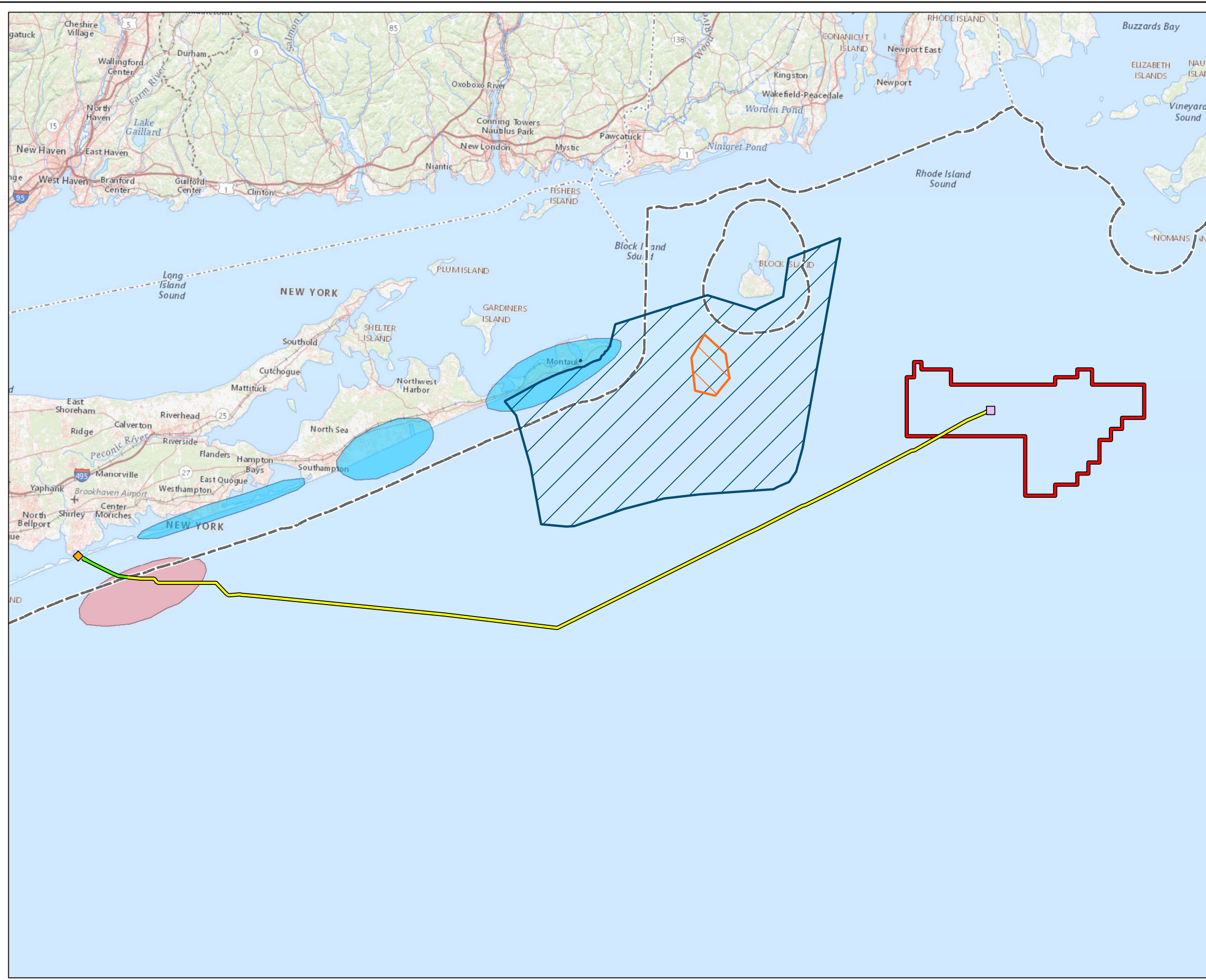

**Figure 4.7.3-2
Wildlife Viewing Areas
Near the SRWF and SRWEC**

Sunrise Wind | Powered by Ørsted & Eversource

- Legend**
- Sunrise Wind Farm (SRWF)
 - Offshore Converter Station (OCS-DC)
 - ◆ SRWEC Landfall Location
 - Sunrise Wind Export Cable (SRWEC-OCS)
 - Sunrise Wind Export Cable (SRWEC-NYS)
 - 3-nm State Waters Boundary
 - Commercial Whale Watching Area (Dominant Use)
 - Commercial Whale Watching Area (General Use)
 - NYSDOS Wildlife Viewing Area
 - Charter/Recreational Fishing and Bird Watching Area

Sources
SeaPlan, Surfrider, and Point 97. Feature class provided by the Northeast Regional Ocean Council and NortheastOceanData.org

Date	09/01/2020 Revised: 12/18/2020
Project Number	2028113199
Prepared By	GC
Reviewed By	LJ

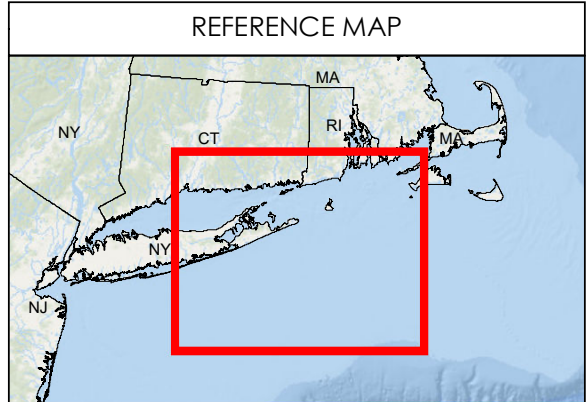
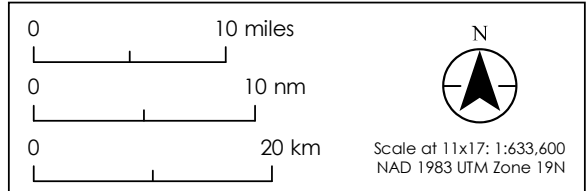

This page intentionally left blank

CONSTRUCTION AND OPERATIONS PLAN

Site Characterization and Assessment of Impacts – Socioeconomic Resources

The OSAMP identified 12 offshore recreational dive sites within the OSAMP study area. The OSAMP defines offshore dive sites as an Area of Particular Concern for their high conservation, cultural, historic, or human use values. NYSERDA's *Offshore Wind Master Plan-Marine Recreational Uses Study* identified six offshore recreational dive sites that were considered to be sensitive within its Area of Analysis, one of which is within the expanded ROI, located southeast of Montauk, NY (NYSERDA 2017). Diving activities occur year-round however are more frequent between May and October (NYSERDA 2017). Figure 4.7.3-3 depicts scuba diving areas near the SWRF and SRWEC. There are two dive sites, the Moriches Anglers site and the SeaWolf site, shown on Figure 4.7.3-3 near the New York State territorial boundary, that are within 1 to 2 mi (1.6 to 3.2 km) of the SRWEC as well as one site, the Suffolk site, just south of the SWRF and within 2 mi (3.2 km) of the SRWEC.

Surface water activities such as kayaking, swimming, windsurfing, paddle-boarding, and surfing generally occur closer to shore than other activities. These activities occur with higher intensity near Montauk, the Hamptons, and Fire Island (NYSERDA 2017).

This page intentionally left blank

V:\1956\active_Task Owner and other Non-BC 1956 Jobs\20281131\199_4.7.3-3_SCUBA.mxd Revised: 2020-12-07 By: hturner

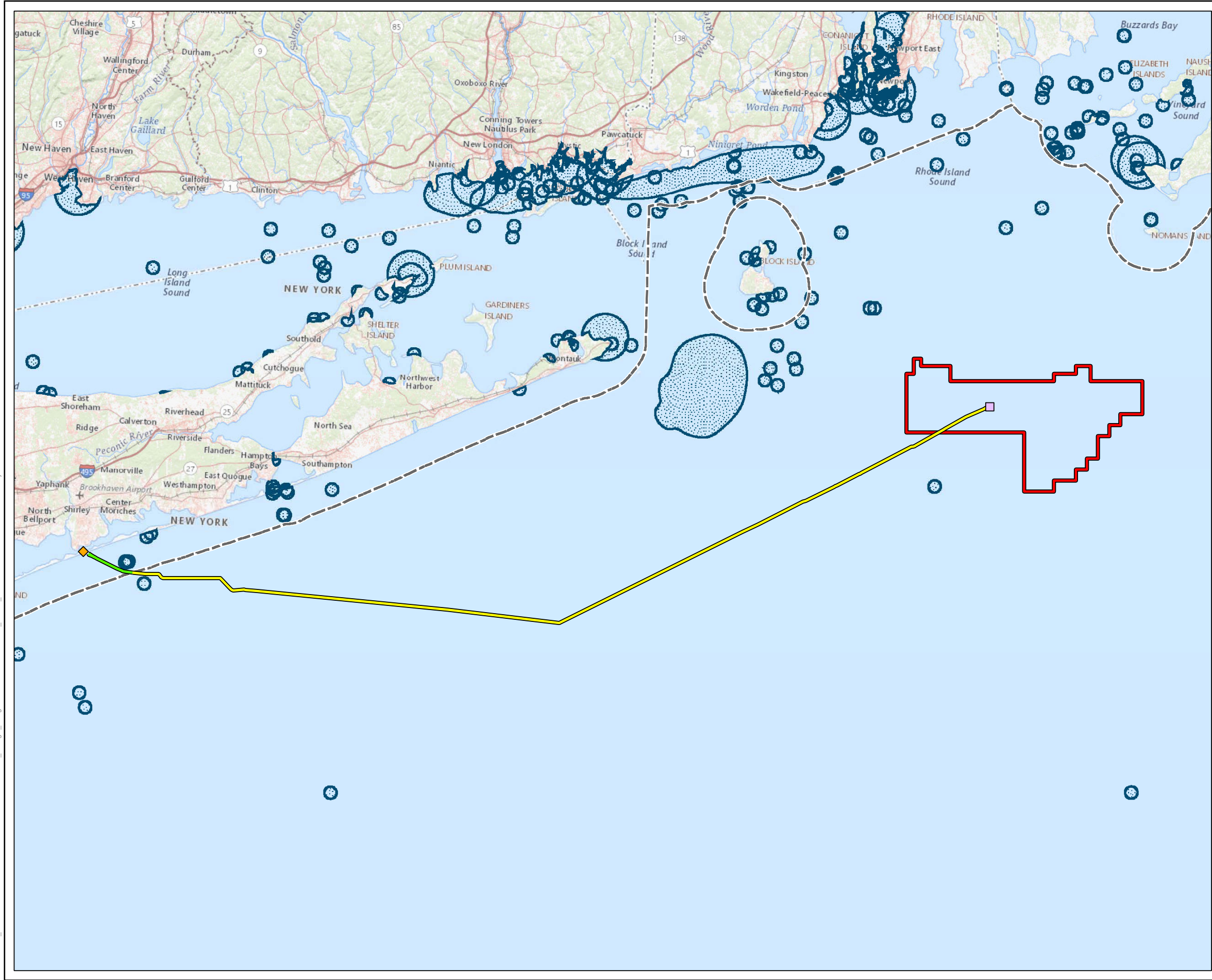

Figure 4.7.3-3
Scuba Diving Areas near
the SRWF and SRWEC

Sunrise Wind | Powered by Ørsted & Eversource

- Legend**
- Sunrise Wind Farm (SRWF)
 - Offshore Converter Station (OCS-DC)
 - ◆ SRWEC Landfall Location
 - Sunrise Wind Export Cable (SRWEC-OCS)
 - Sunrise Wind Export Cable (SRWEC-NYS)
 - 3-nm State Waters Boundary
 - Recreational SCUBA Diving Area

Sources
 Bloeser, J., Chen, C., Gates, M., Lipsky, A., and Longley-Wood, K. 2015. Characterization of Coastal and Marine Recreational Activity in the U.S. Northeast. Point 97, SeaPlan, and Surfrider. Feature class provided by the Northeast Regional Ocean Council and NortheastOceanData.org

Date	09/01/2020 Revised: 12/18/2020
Project Number	2028113199
Prepared By	GC
Reviewed By	LJ

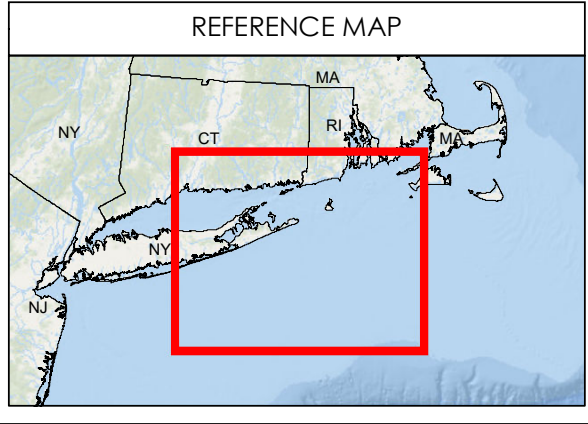
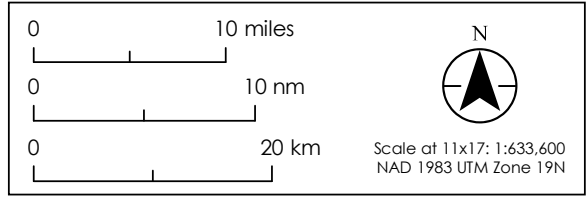

This page intentionally left blank

CONSTRUCTION AND OPERATIONS PLAN

Site Characterization and Assessment of Impacts – Socioeconomic Resources

Cruise ship tourism results in a number of passenger vessels traversing the Project Area. However, 2013 passenger vessel data suggest the density is low in the vicinity of the SRWF and SRWEC, and speed restrictions also apply to these vessels in the vicinity of the SRWF and SRWEC (NYSERDA 2017). Based on analysis in Appendix X – *Navigation Safety Risk Assessment*, pleasure and recreational vessel traffic primarily occur near the coast, with relatively few tracks near the SRWF. Relatively higher levels of traffic occur closer to the coastline. Section 4.8.1 includes additional discussion regarding distribution of pleasure and recreational vessels.

Onshore Recreation and Tourism

A summary of the resources each community offers to attract and support its recreation and tourism economy is provided in Table 4.7.3-1. These resources are major features that contribute to the identity of the communities within the expanded ROI as recreation and tourism destinations including major tourist attractions and festivals. In all, there are 346 public beaches, 226 marinas, 82 harbors, 83 yacht clubs, and 9 national parks within the expanded ROI. The percentages of each of these resources by state are shown in Table 4.7.3-1. For example, in Massachusetts, there are 202 public beaches between Barnstable (150), Bristol (5), Dukes (15), Nantucket (22), and Plymouth County (10), and in New York, there are 72 marinas in Suffolk County within the expanded ROI (see Table 4.7.3-1).

In Massachusetts, Martha's Vineyard, part of Dukes County, is the community closest to the SRWF (approximately 18.9 mi (16.4 nm, 30.4 km) north of the SRWF). Martha's Vineyard is accessible only by air or boat. Ferry access to Martha's Vineyard is available from Woods Hole, MA; Falmouth, MA; Hyannis, MA; New Bedford, MA; Nantucket, MA; Quonset, RI; and New York City, NY (Martha's Vineyard Online 2019).

In Rhode Island, Block Island, part of Washington County, is the next closest community to the SRWF (approximately 16.7 mi (14.5 nm, 26.8 km) north of the SRWF). Like Martha's Vineyard, Block Island is accessible only by air or boat. Ferry access to Block Island is available from New London, CT; Montauk, NY; Newport, RI; and Point Judith, RI (ICF 2012). Elsewhere in Rhode Island, public beaches are prevalent in Washington County including Block Island. Newport County, located on the eastern side of the entrance to Narragansett Bay from Long Island Sound, has a major tourism industry based on its beaches and sailing and yachting reputation and is also known for its jazz and folk music festivals. Washington County also has six lighthouses that draw visitors and contribute to the state's tourism economy; two are on Block Island. Also, harbor cruises are offered out of Narragansett Bay. Water sports such as snorkeling, sailing, parasailing, fishing, boating, wildlife viewing, and kayaking are also popular recreation activities on Block Island.

In New York, Suffolk County, where the Onshore Facilities are located, is the outermost county on Long Island, with multiple summer vacation destinations including Montauk, the Hamptons, and Fire Island. Montauk (approximately 30.5 mi (26.5 nm, 48.1 km) west of the SRWF) can be accessed by ferry from Block Island and New London, by road (NY Route 27), or rail (the LIRR Montauk station). The Hamptons can also be accessed by road (NY Route 27) or rail (LIRR Westhampton, Hampton Bays, Southampton, Bridgehampton, and East Hampton stations). Fire Island can be accessed by ferry from Bayshore, Sayville or Patchogue, NY. The western portion of the island, which includes Robert Moses State Park, can be accessed by road (Robert Moses Causeway) (Bolger 2016). The eastern portion of Fire Island, which includes Smith Point County Park, can be accessed by road (William Floyd Parkway).

CONSTRUCTION AND OPERATIONS PLAN

Site Characterization and Assessment of Impacts – Socioeconomic Resources

Suffolk County has 980 mi (1,577 km) of coastline with two areas of predominant interest to tourists: Southampton and the Fire Island National Seashore (FINS). Southampton is a summer resort area featuring white sand beaches, shops and attractions, and two of America's ten best golf courses (ICF 2012). Fire Island is a 32-mi (51.5-km) long and 0.25-mi (0.4-km) wide barrier island off the southern coast of Long Island, NY (Bolger 2016). The FINS encompasses 19,579 acres (7,923 ha) of protected land, featuring undeveloped sandy beaches, high dunes, forestland, and abundant wildlife (ICF 2012). There are also 17 car-free communities on the island, with a summer population of 20,000 (Bolger 2016). A variety of visitors are attracted to FINS including surfers and nature enthusiasts (ICF 2012), campers, boaters and beachgoers (Bolger 2016). Also attracting visitors is the Fire Island Lighthouse on the western end of FINS, which was first built in 1826 and listed in the NRHP on September 11, 1981 (NPS 2018). In 2015, FINS reported 441,999 visitors to the national seashore. A number of recreational resources are also present in the vicinity of the Onshore Transmission Cable's crossing of the Carmans River, within Southaven County Park. These include hiking, camping, fishing, boat rentals, horseback riding, hunting and boating activities on Carmans River.

CONSTRUCTION AND OPERATIONS PLAN

Site Characterization and Assessment of Impacts – Socioeconomic Resources

Table 4.7.3-3 Inventory and Summary of Water-Based and Waterfront-Dependent Recreation and Tourism Resources by County within the Expanded Region of Interest

	Harbors	Marinas	Yacht Clubs	Public Beaches	National Parks	Description	Major Events ^{a/}
New York-Counties in expanded ROI	20	72	38	60	2	Shores of predominantly white sand beach along the Long Island Sound and Atlantic Ocean	-
Suffolk County	20	72	38	60	2	980 mi (1,577 km) of coastline; the majority is white sand beach for sunbathing, swimming, and beachcombing; popular among sportsmen and surfers; 23,000 acres of protected land in national parks and wildlife refuges. Smith Point County Park; Smith Point Marina; Carmans River; Southaven County Park; Robinson Duck Farm Dog Park; Shinnecock County Park; Napeague State Park; Hither Hills State Park; Montauk Point Lighthouse; Vanderbilt Museum; historic districts (Yaphank and Blydenburgh Farm and New Mill); Fire Island National Seashore; Amagansett, Conscience Point, Elizabeth Alexandra Morton, Seatuck, and Wertheim National Wildlife Refuges	Seafood Festival and Craft Fair
Connecticut-Counties in expanded ROI	5	30	5	10	0	-	-
New London County	5	30	5	10	0	Lengthy, sand-beached coastline (parts industrial). Boating (both offshore and along the Thames River); Beaches with boardwalks, lockers, cafes and food courts, rides, and playgrounds; and Olde Mystic Village; Mystic Seaport/Museum of America and the Sea, U.S.S. Nautilus Museum; Foxwoods and Mohegan Sun Casinos	Sailfest; Sea Music Festival
Massachusetts-Counties in ROI	49	77	24	202	5	-	-
Barnstable County	30	40	4	150	3	550 mi (885 km) of coastline ideal for sunbathers, walkers, snorkelers, and windsurfers and surfers (south- and west-facing beaches). National parks account for approximately 58,000 acres of protected land. Towns of Falmouth and Mashpee; Lengthy, sand-beached coastline; Pilgrim Monument, Kennedy Compound; numerous lighthouses; Woods Hole Oceanographic Institute; Cape Code National Seashore; Mashpee and Monomoy National Wildlife Refuges	Cape Cod Maritime Days Festival, Bourne Scallop Festival
Bristol County	2	20	5	5	1	Coastline along both the Narragansett and Buzzards Bays. Mostly private beach: while parts of the shore are rocky, approximately half is sand beach and caters to activities such as sunbathing and beachcombing. New Bedford Whaling Museum; Battleship Cove/USS Massachusetts; New Bedford Whaling National Historical Park	Whaling City Festival; Feast of the Blessed Sacrament
Dukes County	5	2	3	15	0	Lengthy coastline almost entirely remote sand beach. Popular activities include swimming, beachcombing, and sunbathing; surfing, diving, and boat- and shore-fishing. Several wooded trails for biking and hiking, as well as several areas (including two wildlife refuges) for bird and nature watching. Historic lighthouses; unique architecture; Noman's Land Island National Wildlife Refuge	Striped Bass and Bluefish Derby; JawsFest
Nantucket County	2	4	2	22	1	Lengthy coastline comprised mostly of publicly accessible beach (110 mi of shoreline; 80 mi of beach open to the public). Town of Nantucket; Historic district along the harbor; Nantucket Whaling Museum; Maria Mitchell Association; historic lighthouses; Nantucket National Wildlife Refuge	Boston Pops on Nantucket, Nantucket Sandcastle Day
Plymouth County	10	11	10	10	0	250 mi of coastline with most beaches being private. The Massasoit National Wildlife Refuge protects 195 acres of coastline. Town of Mattapoisett; Lengthy, sand-beached coastline; Mayflower II; Plymouth Rock; Plymouth Plantation; World's End; Massasoit National Wildlife Refuge	Plymouth Waterfront Festival, Marshfield Fair, Annual Cranberry Harvest Celebration
Rhode Island-Counties in ROI	8	47	16	74	2	-	-
Kent County	0	12	4	6	0	North-South Trail and Warwick Light are popular tourist attractions. 45 mi of mostly private coastline; New England Wireless and Steam Museum	East Greenwich Art Festival, Portuguese Holy Ghost Festival

CONSTRUCTION AND OPERATIONS PLAN

Site Characterization and Assessment of Impacts – Socioeconomic Resources

	Harbors	Marinas	Yacht Clubs	Public Beaches	National Parks	Description	Major Events ^{a/}
Block Island (Washington County) ^{b/}	2	2	0	10	0	Undeveloped and sandy beaches, New Shoreham waterfront Aquatic activities include swimming, surfing, snorkeling, and parasailing; fishing, sailing, and boating; wildlife viewing; kayaking along the beaches and through the tidal zones. Onshore activities include hiking, horseback riding, and bicycling on 32 mi (51.5 km) of hiking trails.	Block Island Race Week; Block Island Music Festival; 15k Run Around the Block; Lion's Clam Bake
Newport County	4	13	3	18	1	175 mi of coastline (mostly rocky and wooded); remote public and private sand or pebble beaches; Beaches for sunbathing, walking, surfing, and swimming; Sachuest Point National Wildlife Refuge (242 acres of protected land); Touro Synagogue national park; Fort Adams State Park; Fort Hamilton; Fort Barton Woods and Revolutionary War Redoubt; Christopher Columbus Statue and Monument Tourism draw is boating and yachting; Newport Mansions/Bellevue Avenue Historic District; and restaurants and retail.	Newport Kite Festival; Black Ships Festival; Newport Folk and Jazz Festivals; multiple boating races
Providence County	0	6	3	0	1	Coastal recreation is minimal because the industrial waters of the inner bay provide for poor swimming and ocean recreation activities, adjacent parkland and East Bay Bicycle Path. Roger Williams Park; Waterplace Park; First Baptist Church of Providence; Roger Williams National Memorial	Waterfire
Washington County	4	16	6	50	0	Lengthy coastline – almost entirely of uninterrupted sandy beach. Kayaking, sailing, and harbor cruises in Narragansett Bay; sunbathing, beachcombing, swimming, and surfing on the Atlantic coast; Westerly Armory Museum; six historic lighthouses; Smith's Castle; Block Island, John Chafee, Ninigret, and Trustom Pond National Wildlife Refuges	Wickford Art Festival; Block Island Race Week; Americas Cup World Series Races
Total in expanded ROI	82	226	83	346	9	-	-
Distribution by State (%)							-
New York	24	32	46	17	22	-	-
Connecticut	6	13	6	3	0	-	-
Massachusetts	60	34	29	58	56	-	-
Rhode Island	10	21	19	21	22	-	-
SOURCE: ICF 2012; NPS 2019; USFWS 2019							
NOTES:							
^{a/} Major events relevant to recreation and tourism are listed. This is not intended to be an all-inclusive list of events.							
^{b/} Block Island counts are included for reference and are already represented in the Washington County counts.							

CONSTRUCTION AND OPERATIONS PLAN

Site Characterization and Assessment of Impacts – Socioeconomic Resources

4.7.3.2 Potential Impacts

IPFs that could potentially result in impacts to recreation and tourism resources are indicated on Figure 4.7.3-4. The potential for recreation and tourism impacts from construction, O&M, and decommissioning of the SRWF, SRWEC, and Onshore Facilities is evaluated in this section.

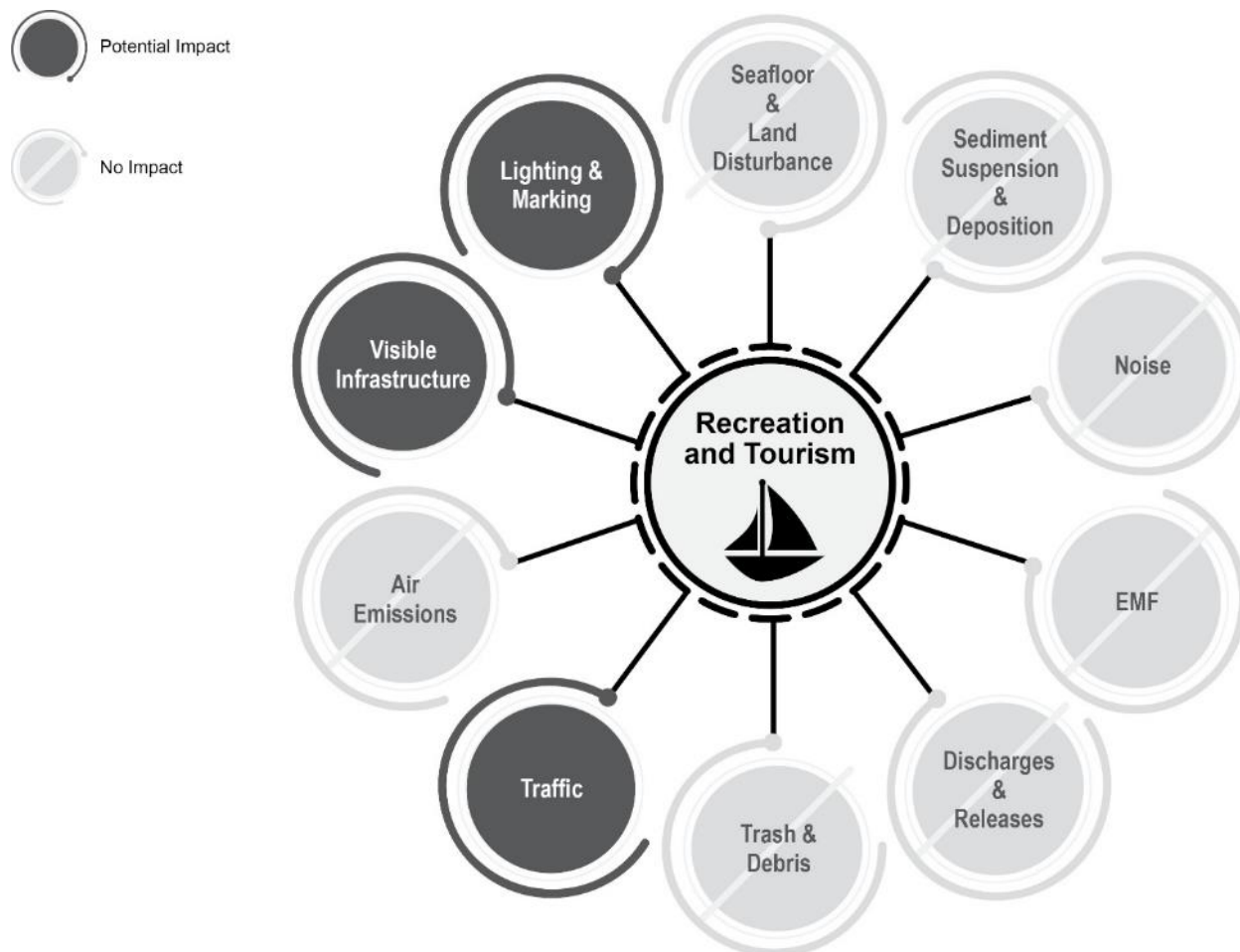

Figure 4.7.3-4 Impact-Producing Factors on Recreation and Tourism

The potential for impacts on recreation and tourism resources results from changes to natural resources (e.g., altered conditions for fishing, scuba diving, or sight-seeing) or from the public perception of offshore wind facilities (e.g., interest in facility tours, preference for undeveloped landscapes) (ICF 2012). The scale of these impacts varies widely and can be positive or negative. Potential negative impacts could cause tourists to avoid a destination, such as a State Park, or could provide a new source of coastal tourism and draw new visitors, as demonstrated by tourism at the Block Island Wind Farm and by windfarm tours available throughout the UK, Denmark, and Germany. For example, the Block Island Ferry now offers hour-long high-speed cruises with a narrated tour of the Wind Farm for \$25 per adult and \$15 per child (Block Island Ferry 2020).

CONSTRUCTION AND OPERATIONS PLAN

Site Characterization and Assessment of Impacts – Socioeconomic Resources

The literature about potential and existing offshore wind projects also suggests that the anticipated impacts do not necessarily correspond with actual impacts (ICF 2012). Relative to the waters around Block Island, a multi-year study of recreational boating near the Block Island Wind Farm was performed before, during, and after construction (INSPIRE 2016, 2017, 2018). A preconstruction recreational boating survey was conducted in the summer of 2015, a 2016 survey represented conditions during construction, and a 2017 study represented conditions after construction. These surveys were designed to determine if recreational boating intensity in the study's APE (the area within 0.58 mi [0.93 km] of the Block Island Wind Farm wind turbines) would be affected by the presence of the turbines. The results "suggest that the distribution of boating intensity returned to pre-construction patterns after construction and during operations (INSPIRE 2018)."

Sunrise Wind Farm

Potential onshore and offshore effects on recreation and tourism resources from construction of the SRWF could arise from vessel traffic, visible infrastructure, and lighting and marking. The potential for effects on recreation and tourism is evaluated below.

Construction

Traffic

Offshore effects could be experienced by those recreating near the SRWF and by boaters traversing Block Island and Rhode Island Sounds. As outlined in detail in Section 4.8.1, pleasure and recreational vessel traffic primarily occur near the coast with relatively few tracks in the SRWF. Passenger vessels (including ferries, cruise ships, and local sightseeing vessels) primarily follow established routes near the coast with very few passenger vessel tracks crossing the SRWF. Details on the type and number of vessels expected to operate for the construction of the SRWF are included in Table 3.3.10-3. However, not all vessels presented in Table 3.3.10-3 (69 total) are expected to be operating at one given time, and the increase in construction vessel traffic will be temporary. Construction activities could affect navigation of smaller vessels if smaller vessels operate close to construction work vessels during construction operations. However, this risk would be mitigated by a safety zone anticipated to be implemented by the USCG during construction operations. In addition, Sunrise Wind will implement a communication plan during construction to inform mariners of construction activities, vessel movements, and how construction activities may affect the area. Communication will be facilitated through maintaining a Project website, the Fisheries Liaison, submitting local notices to mariners, and vessel float plans in coordination with the USCG. With these measures implemented, the SRWF is expected to have a minimal and temporary impact on marine traffic, including recreation and tourism related marine traffic during construction. In addition, Sunrise Wind will request, and it is expected the USCG will establish, temporary safety zones around all marine construction activities including each WTG site, OCS-DC site, and each cable-laying vessel. With these measures implemented, the SRWF is expected to have short-term and limited effects on recreation activities in the vicinity of the SRWF. In addition, Sunrise Wind will coordinate its construction activities with recreational events that may be affected (e.g., organized sailboat races).

CONSTRUCTION AND OPERATIONS PLAN

Site Characterization and Assessment of Impacts – Socioeconomic Resources

Visible Infrastructure

As discussed in more detail in Section 4.5.1, it is likely that construction vessels (jack-up barges, cranes, and support vessels) will be visible from some onshore recreation and tourism resources. These effects will be temporary during construction and limited due to the distance from the coast; therefore, no measurable effects are anticipated for onshore recreational uses. The visual effects on offshore recreational users during construction are anticipated to be greater due to the potential increased proximity but are still considered limited and short-term.

Lighting and Marking

USCG-approved navigation lighting is required for all Project-related vessels and for both the OCS–DC and the WTGs during construction so that the vessels and structures are visible to other vessels. In general, recreation and tourism resources are utilized during daytime hours, so any effects on recreational activities would be short-term and limited. The visibility will be temporary in nature and, at times, will be obscured from view due to atmospheric conditions or the curvature of the Earth.

Operations and Maintenance

Traffic

A summary of SRWF routine maintenance activities and the anticipated frequency at which they may occur is provided in Table 3.5.2-1, Table 3.5.3-1, and Table 3.5.4-1, and safety zones may be established around O&M activities on a case-by-case basis in coordination with the USCG. Based on the frequency of O&M activities, limited, temporary disruptions to recreation and tourism activities could occur for those activities that are located within the immediate vicinity of the SRWF.

Over the long-term operation of the SRWF, once construction is complete, there is potential for positive effects to recreation and tourism in the region from wind farm-related tourism. Potential positive effects could result in an increase in tourism-related vessel traffic to the SRWF (e.g., boat tours of the SRWF). There are no permanent navigation exclusion areas planned for vessels that would restrict boat traffic for recreational uses (e.g., fishing) or tourism.

Visible Infrastructure

As described in Section 4.5.1, viewshed mapping demonstrated that the WTGs have the potential to be visible from a relatively small portion of the communities within the Expanded ROI. Open views toward the SRWF, as indicated by visibility of the ocean, were concentrated within limited areas of the shoreline and were largely restricted to beaches, bluffs, dunes, open fields, salt ponds, road corridors, and cleared residential yards where lack of foreground trees allowed for unscreened views of the ocean. A study completed by the University of Delaware evaluated the impacts of visible offshore WTGs on recreation and tourism, specifically beach use. The responses to the visual simulations were varied. The visual simulations showed the WTGs at a distance of 15 mi (24.1 km). Most respondents, approximately 68 percent, reported that it would not improve or worsen their experience. Others (16 percent) reported their experience would be improved or worsened (Parson and Firestone 2018). Another study conducted by the University of Rhode Island evaluated the impacts of visible WTGs by interviewing a number of focus groups.

CONSTRUCTION AND OPERATIONS PLAN

Site Characterization and Assessment of Impacts – Socioeconomic Resources

Overall, the focus groups concluded the impacts to be more beneficial than negative based on the expectation to lead to new opportunities for charter boat businesses. Additionally, the majority of participants saw the visual effect of the Block Island Wind Farm as primarily beneficial although some visitors and boaters expressed negative perceptions (Bidwell and Smythe 2017). Due to the overall distance from the coast and the results of the recent studies, the effects on recreation and tourism are expected to be minimal and both negative and beneficial.

Lighting and Marking

The proposed WTGs will be equipped with both aviation obstruction warning lights on top of each nacelle and USCG navigation warning lights on the platform near the tower base. The lighting serves as a required safety feature for navigating vessels. As described in Section 4.5.1, the impacts will be variable and will depend on the existing visual quality of the resources (sensitivity to change), the distance from the SWRF, and visibility of the SWRF. Night lighting could potentially affect the experience of vacationers in settings where they currently experience dark nighttime skies. However, in many places, nighttime visibility will be limited due to several factors including existing shoreline and offshore light sources that already affect nighttime ocean views and the distance of the SRWF from mainland viewpoints.

Sunrise Wind Export Cable

Potential onshore and offshore effects on recreation and tourism resources from the construction and O&M of the SRWEC—OCS and SRWEC—NYS could arise from vessel traffic, visible infrastructure, and lighting and marking. Effects within the OCS and NY portions of the cable are similar except for level of impact to recreational boating traffic based on the location of the activity. It is anticipated that impacts from construction and O&M activities have a greater potential for impact the closer they occur to the shoreline since the level of recreational vessel activity is greater. Regardless of location, due to the temporary and transient nature of the activity, any potential effects will be limited and short-term. The potential for effects to recreation and tourism are evaluated below.

Construction

Traffic

Impacts from vessel traffic within the vicinity of the SRWEC during construction is limited to the discrete areas where construction activities are occurring. Recreational vessel traffic within the vicinity of the SRWEC—OCS is limited to long distance boat sailing races and offshore fishing and whale/shark watching expeditions (Figure 4.7.3-1 through Figure 4.7.3-3). Risks would be mitigated by a safety zone anticipated to be implemented by the USCG during construction operations. Sunrise Wind will implement a communication plan during construction to inform mariners of construction activities, vessel movements, and how construction activities may affect the area. Communication will be facilitated through maintaining a Project website, the FLO, submitting local notices to mariners, and vessel float plans in coordination with the USCG. Sunrise Wind will request, and it is expected the USCG will establish, temporary safety zones around each cable-laying vessel. With these measures implemented, the SRWEC is expected to have a minimal and temporary effect on recreation and tourism related marine traffic during construction.

CONSTRUCTION AND OPERATIONS PLAN

Site Characterization and Assessment of Impacts – Socioeconomic Resources

Visible Infrastructure

Similar to the impacts associated with the SRWF construction, visible impacts are limited to construction equipment. The extent of the visibility is based on where along the SRWEC the construction activity is occurring. The effects to recreation and tourism are limited to the window in which the construction activities are occurring and are visible to those recreating in the vicinity of the viewshed. Therefore, the effects are expected to be limited and short-term.

Lighting and Marking

During construction, the effects of lighting and marking will be similar to those described for the SRWF. Lighting during construction activities will be limited to the minimum required by BOEM and USCG for safety during construction activities. Construction activities occurring at nighttime will likely require lighting associated with the barges and vessels along the SRWEC route; however, in general, recreation and tourism resources are utilized during daytime hours, and so these potential effects are considered short-term and limited.

Operations and Maintenance

Traffic

The SRWEC is not expected to require maintenance unless a fault or failure occurs. Depending on the location of the fault or failure, O&M activities may potentially transect recreational boating routes or distance sailing race routes. In the event that repairs are needed, O&M activities would result in short-term, limited offshore effects on recreation and tourism resources.

Visible Infrastructure

Similar to the construction phase, visible infrastructure is limited to presence of construction vessels that may be needed for a repair. These limited repair activities are expected to result in limited and short-term effects on people using the surrounding area for recreation.

Lighting and Marking

Similar to O&M traffic-related effects, effects from lighting would only occur in the event of a fault or failure. Depending on the location of fault or failure, visible structure/lighting associated with O&M activities would result in short-term and limited disruptions to recreation and tourism resources.

Onshore Facilities

Construction of the Onshore Facilities has the potential to result in short-term, limited construction effects from traffic, visible infrastructure and lighting and marking, as well as long-term, negligible effects during O&M from visible infrastructure and lighting on recreation and tourism resources, as discussed below.

CONSTRUCTION AND OPERATIONS PLAN

Site Characterization and Assessment of Impacts – Socioeconomic Resources

Construction

Traffic

Construction of the Onshore Facilities will result in temporary reduction in access to recreational areas, including portions of the parking lots at Smith Point County Park and Smith Point Marina, as well as temporary lane or road closures along routes to other recreational areas such as Southaven County Park. The level of impact to these recreational resources will differ depending on the location, construction activity occurring, and time of year. Construction of both the Landfall HDD and ICW HDD is expected to occur outside peak public recreation periods. Impacts to local transportation and traffic would be minimized to the extent practicable by implementing measures such as traffic and communications plans and construction scheduling that avoid peak public recreation periods. Impacts to Southaven County Park will also be temporary and minimized to the extent practicable and construction activities are not anticipated to impact areas used for recreational activities as the HDD workspace locations have been sited along the roadway corridor of Victory Avenue and an inactive, former park entrance road; however, some tree clearing will be required.

Visible Infrastructure

The presence of construction activities associated with the Landfall HDD, TJB, and ICW HDD will result in limited and temporary effects on recreational users within the Smith Point County Park and Smith Point Marina. These activities are expected to occur outside the peak public recreation period.

The presence of other construction activities for the Onshore Transmission Cable will occur within existing ROW. Certain users, such as bikers and runners that use bike routes in the area, are likely to be sensitive to the visual changes during construction. However, these effects associated with construction will be temporary in nature and will not significantly impact the enjoyment of the recreational resources.

Construction of the OnCS–DC will occur at the Union Avenue Site within a largely industrial area. Similar to the Onshore Transmission Cable, bikers and runners that use the Suffolk County Central Corridor Bike Route that runs along Union Avenue are likely to be sensitive to visual changes during construction, but these effects will be temporary and will not significantly impact the enjoyment of the recreational resources, particularly given the presence of other industrial activity in the vicinity.

Lighting and Marking

Lighting associated with construction of the Onshore Facilities will be limited to specific nighttime activities. Since these activities will occur outside timeframes when recreational users are likely to be present, no significant impacts are expected to recreational users.

CONSTRUCTION AND OPERATIONS PLAN

Site Characterization and Assessment of Impacts – Socioeconomic Resources

Operations and Maintenance

Traffic

There would be no need for regular maintenance of the underground Onshore Transmission Cable and Onshore Interconnection Cable unless there is a failure or malfunction requiring exposure and repair. No traffic impacts are expected; therefore, no impacts on recreation and tourism during O&M of the Onshore Facilities are expected.

Visible Infrastructure and Lighting

The OnCS–DC will be located at the Union Avenue Site, within the vicinity of other similar uses, including an existing substation. As described in Section 4.5.1, potential visibility of the OnCS–DC will be generally limited, and where visible, views would be limited to the uppermost portions of the proposed lightning masts. General yard lighting will be provided within the site for assessment of equipment. In general, yard lighting will be minimal at night and subject to state and local requirements unless there is work in progress on site or lights are required for safety and security purposes. The only recreational or tourism resource within the vicinity of this site is the nearby bike route. As noted for construction, the presence of the OnCS–DC will not negatively affect the enjoyment of the recreational resources, particularly given the presence of other industrial activity in the vicinity.

4.7.3.3 Proposed Environmental Protection Measures

Several environmental protection measures will help to avoid or reduce potential impacts to recreation and tourism.

- The construction of the Landfall and ICW HDD is expected to occur outside the summer tourist season, which is generally between Memorial Day and Labor Day. The construction schedule for the remaining Onshore Facilities will be designed to minimize impacts to the local communities to the extent feasible.
- Sunrise Wind will coordinate with local authorities and develop an MPT plan as part of the Project's EM&CP to minimize potential traffic impacts during construction.
- A comprehensive communication plan will be implemented during offshore construction to inform all mariners, including commercial and recreational fishing vessels, and recreational boaters, of construction activities and Project-related vessel movements. Communication will be facilitated through a Project website, public notices to mariners and vessel float plans, and a Fisheries Liaison. Sunrise Wind will submit information to the USCG to issue Local Notice to Mariners during offshore installation activities.
- The communication plan will include outreach to stakeholders in the offshore recreational and tourism industry to minimize impacts to recreational events (e.g., sailboat races).

CONSTRUCTION AND OPERATIONS PLAN

Site Characterization and Assessment of Impacts – Socioeconomic Resources

4.7.4 Commercial and Recreational Fisheries

This section describes the affected environment and potential effects from the construction and operation of the Project as they relate to commercial and recreational fisheries. Commercial and recreational fishing are an important part of the cultural and economic history of the southern New England (SNE) region. For example, lobster, sea scallops, crab, and a variety of fish are important contributors to the economy. Total revenue of commercial landings in New England in 2015 was approximately \$1.2 billion, and landings were approximately 599 million pounds (NOAA Fisheries 2017a). Recreational fishing, either from shore, a private vessel, or a vessel for-hire, is important to SNE coastal economies. A NOAA report on the Economic Contribution of Marine Angler Expenditures (Lovell et al. 2020) states that saltwater anglers nationwide spent an estimated \$24 billion in sales, \$14 billion in value added to the GDP, and \$7.9 billion in income to the economy in 2017. In 2017, five million residents of Atlantic Coast states participated in marine recreational fishing, with 12 percent of trips originating in New York (NOAA Fisheries 2018).

Sunrise Wind has committed to engaging with stakeholders in the commercial and recreational fishing communities that are active in the areas encompassed within the SRWF and SRWEC. Appendix B was formulated by Sunrise Wind to gather local knowledge from the region's fishermen and to establish open and reliable communication with the fishing industry. Sunrise Wind has established an experienced team of Fisheries Liaisons and Fisheries Representatives to facilitate a two-way process of communication through individual outreach via email, text message, or in person, and that also includes, but is not limited to, public presentations, listening sessions, Notices to Mariners, and updates to websites and social media. Sunrise Wind aims, where practicable, to mitigate and reduce potential impacts to fishing activities as outlined in Appendix B and the *Fisheries Mitigation Plan for Sunrise Wind* (Sunrise Wind 2019), which is available on the NYSERDA website and will be updated throughout Project development. Information shared with stakeholders includes plans for the construction and installation of the Project and key features of the Project including layout and relevant statistics such as burial depth of cables. An information sheet and questionnaire concerning fishing practices in the vicinity of the wind farm are being distributed to each known fisherman operating in the Project Area, which to date includes approximately 80 individuals. The information sheet and questionnaire also are posted on Orsted NA's 'Information for Mariners' webpage, provided to the NYSERDA Fisheries Technical Working Group (F-TWG), Massachusetts Fisheries Working Group and Rhode Island Fisheries Advisory Board, and provided to stakeholders during port visits.

Species that are targeted for commercial and recreational fishing in southern New England are managed through Fishery Management Plans (FMPs) by the NEFMC, the Mid-Atlantic Fishery Management Council (50 CFR 600.105), the Atlantic States Marine Fisheries Commission, or some combination of these (NOAA Fisheries 2017b). Some FMPs include multiple species because they share habitat and are often fished using the same gear type. Commercial fisheries can be grouped into broad categories by the type of fishing gear used: mobile-gear, which is used while the vessel is in motion, such as trawls and dredges; and fixed-gear, which is set and retrieved later, such as lobster pots and gill nets. Detailed information on fishing gear types and their use is provided as fact sheets by the Food and Agricultural Organization of the United

CONSTRUCTION AND OPERATIONS PLAN

Site Characterization and Assessment of Impacts – Socioeconomic Resources

Nations²⁴. Recreational fishing activity can be categorized by fishing mode (charter boat, party boat, private boat, or shore) and by fishing location (inland, state territorial sea [shore to 3 nm {5.5 km}], and federal Exclusive Economic Zone [more than 3 nm {5.5 km}]) (NOAA Fisheries 2019).

The descriptions of the affected environment and assessment of potential impacts on commercial and recreational fisheries were developed by reviewing current public data sources related to commercial and recreational fisheries including state and federal agency-published papers and databases, online data portals and mapping databases (e.g., federal vessel trip reports [VTR], federal VMS data, state vessel trip reports, and the Marine Recreational Information Program), environmental studies, published scientific literature relating to relevant commercial and recreational fisheries studies, and correspondence and consultation with federal and state agencies and fisheries stakeholders. Specific requirements for submittal of commercial and recreational fisheries information within this COP are provided in BOEM's *Guidelines for Providing Information on Fisheries Social and Economic Conditions for Renewable Energy Development on the Atlantic Outer Continental Shelf Pursuant to 30 CFR Part 585* (BOEM 2020). A description of the commercial and recreational fisheries within the SRWF and along the SRWEC is provided below, followed by an evaluation of potential Project-related impacts. More detailed information explaining the data and analyses used to assess commercial and recreational fisheries resources within the SRWF and within a 106-mi (171-km)-long, 6.2-mi (10 km)-wide SRWEC fisheries study corridor are presented in Appendix V – *Commercial and Recreational Fisheries Data Report*.

Two primary sources of information for commercial fisheries were incorporated into this analysis. Federal VTR and federal VMS data were the best available sources to understand which commercial fisheries may be affected by the SRWF, SRWEC–OCS, and SRWEC–NYS. The federal VTR dataset has the advantage of providing a 'census' of almost all commercial fisheries that are active on the Atlantic coast from Maine to North Carolina. VTR data can be used to provide a reasonable estimate of fishing activity, and can be examined through the landing port, the landed species, and the gear type used. The most recent decade of VTR data available (2009–2018) were requested from NOAA Fisheries for SRWF (including a 1-km buffer) and the SRWEC fisheries study corridor (including a 5-km buffer from the cable centerline). The SRWF buffer was applied to account for potential activity around the margins of the SRWF, and the SRWEC fisheries study corridor accounts for potential shifts in the cable route. VMS data also are valuable because they provide precise vessel locations; however, fishing locations are approximations based on data filtered by vessel speed to isolate fishing locations from the vessel's path of transit. As with VTR data, VMS data can provide a reasonable estimate of important fishing locations and can be examined for specific fisheries that were required to report to the VMS program. One caveat is that VMS data do not provide complete coverage for all FMPs; i.e., there is not 100 percent reporting for some FMPs for some years.

²⁴ <http://www.fao.org/fishery/geartype/search/en>

CONSTRUCTION AND OPERATIONS PLAN

Site Characterization and Assessment of Impacts – Socioeconomic Resources

In addition, state VTR data are useful because vessels that only have state commercial fishing permits are not included in the federal VTR data set. Federal VTR data only describe commercial fishing activity in state and federal waters by vessels that hold a federal permit or both a state and federal fishing permit. State-permitted vessels must report their catch, including the federal statistical area within which fishing occurred (Appendix V). Landing permits allow a vessel from a particular state to fish in another state's waters and land its catch in the home state. State VTR data reported to the Connecticut Department of Energy and Environmental Protection (CT DEEP), Massachusetts Division of Marine Fisheries (MADMF), New York State Department of Environmental Conservation (NYSDEC), and Rhode Island Department of Environmental Management (RIDEM) were requested from the Atlantic Coastal Cooperative Statistics Program (ACCSP 2019) for fishermen who fish exclusively in state waters. The state VTR data were assessed for fishing activity within and around the immediate vicinity of the SRWEC fisheries study corridor, where infrastructure will be located, and long-term vessel activity will occur.

Transit to and from remote ports will be limited to short-term use of these ports during the construction phase only, therefore Project-generated transit will not add significantly more traffic beyond existing levels. Fishing activity was characterized in terms of landed pounds of target species, the landing port, and the gear category. Results of an analysis of commercial fisheries data for the years 2011 through 2016, as reported by the RIDEM (RIDEM 2017) were also reviewed. The complete results of the state VTR data analyses are provided in Appendix V. Other data sources for fishing activity near the SRWF and SRWEC include Globalfishingwatch.com, Marinetraffic.com, Northeastoceandata.org, Midatlanticocean.org, and Aislive.com.

Data from the Marine Recreational Information Program (MRIP) were used to summarize recreational angler-trips from surrounding states; however, this dataset does not include fishing locations, so it can only be used to characterize the relative intensity of fishing activity among states and over time. To characterize recreational fishing activity in the SRWF and SRWEC, the number of angler trips leaving from the five surrounding states (New York, Connecticut, Massachusetts, New Jersey, and Rhode Island; Appendix V), was summarized using the last five years of available recreational angler-trip data (2015 to 2019). The limitation of the MRIP data set is that it does not include a spatial component; the only location information available is the categorization of fishing location into state or federal waters. Given that we cannot assign estimated angler effort to any location in the ocean, it is impossible to estimate recreational effort near the SRWF and SRWEC explicitly. For this reason, the MRIP data must be considered in conjunction with stakeholder input provided through the communication and engagement program that Sunrise Wind has developed for this purpose.

CONSTRUCTION AND OPERATIONS PLAN

Site Characterization and Assessment of Impacts – Socioeconomic Resources

4.7.4.1 Affected Environment

The coastal waters of southern New England have diverse habitats that are defined by their temperature, salinity, pH, physical structure, biotic structure, depth, and currents. The unique combination of habitat characteristics shapes the community of fish and invertebrate species that inhabit the area. Benthic communities have experienced increased water temperatures in the region in the past several decades, and average pH is expected to continue to decline as seawater becomes more saturated with carbon dioxide (Saba et al. 2016). Acidification of seawater is associated with decreased survival and health of organisms with calcareous shells (such as the Atlantic scallop and hard clam), but less is known about direct effects of acidification on cartilaginous and bony fishes. The ranges of dozens of groundfish species in New England waters have shifted northward and into deeper waters in response to increasing water temperatures (Nye et al. 2009; Pinsky et al. 2013), and more species are predicted to follow (Kleisner et al. 2017; Selden et al. 2018). The black sea bass, identified as particularly sensitive to habitat alteration (Guida et al. 2017), has been increasing in abundance over the past several years and is expected to continue its expansion in southern New England as water temperatures increase (Kuffner 2018; McBride et al. 2018). Several pelagic forage species have been increasing in the region including butterfish, scup, squid (Collie et al. 2008), and Atlantic mackerel (McManus et al. 2018). Perhaps counterintuitively, distributions of other species are reported to be shifting southward including spiny dogfish, little skate, and silver hake (Walsh et al. 2015). It has been suggested that the spiny dogfish may replace the Atlantic cod as a major predator in southern New England as the cod is driven north by warm waters that the spiny dogfish tolerates well (Selden et al. 2018).

Further temperature increases in southern New England are expected to exceed the global ocean average by at least a factor of two, and ocean circulation patterns are projected to change (Saba et al. 2016). Distributional shifts are occurring in both demersal and pelagic species, perhaps mediated by changes in spawning locations and dates (Walsh et al. 2015). Southern species, including some highly migratory species such as mahi that prefer warmer waters, are expected to follow the warming trend and become more abundant in the area (Walsh et al. 2015). Climate change may also be affecting the migrations of anadromous fish in the region. The herrings, shad, and sturgeon were identified as having high biological sensitivity to adverse effects of climate change (Hare et al. 2016). In addition to physiological effects of temperature and pH, anadromous fishes face a physical risk caused by flooding in their spawning rivers.

The affected environment was characterized based on several types of data to determine which fisheries, as defined by landing port, landed species or FMP, and gear, potentially will be affected by the SRWF and/or SRWEC. Aquaculture activity was characterized near the SRWEC fisheries study corridor using data accessed from the Northeast Regional Ocean Council (NROC 2019) and the NYS Department of Environmental Conservation (NYSDEC 2020). In addition, Orsted held over 100 meetings with over 80 individual fisheries stakeholders on the topic of the Sunrise Wind Farm Project through its team of Fisheries Liaison and Fisheries Representatives (Appendix B). Stakeholders fishing within SRWF or in the vicinity of the SRWEC most commonly were using a bottom trawl, scallop dredge, clam dredge, or lobster/crab pots (Table 4.7.4-1).

CONSTRUCTION AND OPERATIONS PLAN

Site Characterization and Assessment of Impacts – Socioeconomic Resources

Table 4.7.4-1 Stakeholders and Gears Used to Fish in the SRWF or the Vicinity of SRWEC

Gears	# of Individuals
Aquaculture	1
Bottom trawl	48
Charter vessel	6
Clam dredge	14
Scallop dredge	182
Gillnet	9
Handline/rod and reel	4
Midwater trawl	6
Pots-conch	5
Pots-fish	7
Pots-lobster/crab	11
Recreational by hand	1

Sunrise Wind Farm

Commercial fisheries active in the SRWF encompass a wide range of gears, species, and landing ports. Table 4.7.4-2 summarizes the fisheries most active in SRWF, based on federal fisheries data (Appendix V). A full list of the fisheries active in the SRWF is provided in Appendix V. Based on available data, the biggest commercial fisheries near the SRWF in terms of revenue and pounds landed include both mobile gear types (bottom trawl, dredge, and mid-water trawl) and fixed gear types (gill net and pots) and harvest by hand (Appendix V). Bottom trawl fishing accounted for the greatest average annual revenue (\$692,726) and landings (955,748 pounds) from within SRWF, followed by fishing with gillnets (\$615,420 and 734,490 pounds). The top species groups reported on VTRs by federally permitted vessels in terms of average annual revenue were monkfish, scallops, flounders, skate wings, American lobster, squid, hakes, and scup. The monkfish fishery accounted for the greatest average annual revenue from landings within SRWF (\$409,960), followed by landings of scallops (\$267,163), flounder (\$262,740), and skate wings (\$229,704). Vessels originating from New York, Connecticut, Massachusetts, New Jersey, and Rhode Island conducted the most federally permitted fishing activities within the SRWF. The greatest average annual revenue generated by federally permitted vessels in the SRWF were from landings in Rhode Island (\$1,204,910), followed by Massachusetts (\$1,195,615), and New York (\$50,480).

CONSTRUCTION AND OPERATIONS PLAN

Site Characterization and Assessment of Impacts – Socioeconomic Resources

Fishing occurrence throughout the SRWF and variation in intensity of fishing activity by location is challenging to accurately and precisely categorize with available data sources. Therefore, it is important to engage key stakeholders to identify how the area around the Project is used for commercial and recreational fishing. VMS data for several commercial fisheries indicate respective levels of intensity of vessel traffic and fishing activity in the SRWF. The location of the fishing effort varied based on the species or species assemblage that was targeted. Maps that depict the federal VMS data (Appendix V) provided a qualitative estimate of fishing location for a particular gear type or target species. The available data suggest that most fisheries do not have expansive areas of high relative fishing intensity within the SRWF compared with nearby waters (Appendix V). Fisheries that had the most activity in the SRWF were groundfish (large-mesh multispecies or northeast multispecies), Atlantic herring, pelagic species (herring/mackerel/squid), monkfish, surfclam/ocean quahog, sea scallop, and squid.

Table 4.7.4-2 Commercial Fisheries Most Active in the SRWF with a 1-km Buffer

Location	Gears	Species	Landing State	
SRWF	Mobile Gears:	Monkfish	Rhode Island	
	Bottom trawl	Scallops	Massachusetts	
	Dredge	Flounders	New York	
	Mid-water trawl	Skate wings	Connecticut	
	Fixed Gears:	American lobster	New Jersey	
	Gillnets	Squid		
	Pot	Hakes		
	By hand	Scup		
	SOURCE: Federal VTR Data			

There are few data sources available that describe recreational fishing activity. Data from MRIP were used to summarize recreational angler-trips from surrounding states; however, this dataset does not include fishing locations, so it can only be used to characterize the relative intensity of fishing activity among states and over time. To characterize recreational fishing activity in the SRWF and SRWEC, the number of angler trips leaving from the surrounding states (New York, Connecticut, Massachusetts, New Jersey, and Rhode Island; Appendix V) was summarized using the last five years of available recreational angler-trip data (2015 to 2019). For all states surveyed, most recreational fishing occurred within the respective state waters (Appendix V). Average annual fishing effort was highest for New York (14.1 million trips), followed by New Jersey (12.9 million trips), Massachusetts (7.2 million trips), Connecticut (3.7 million trips), and Rhode Island (2.8 million trips).

CONSTRUCTION AND OPERATIONS PLAN

Site Characterization and Assessment of Impacts – Socioeconomic Resources

Sunrise Wind Export Cable

Table 4.7.4-3 summarizes commercial fisheries most active along the SRWEC–OCS and SRWEC–NYS) fisheries study corridor by gear type, species and landing state from federal VTR data, which were not reported at a scale sufficient to distinguish between the SRWEC–OCS and the SRWEC–NYS. However, federal VMS vessel intensity maps (Appendix V) can be used to locate areas of relatively high vessel intensity by fishery type. Among the commercial fisheries that were active within the SRWEC (Appendix V), the top fisheries reported on VTRs by federally permitted vessels by revenue used the following gear types: dredge, bottom trawl, gillnets, pot, and mid-water trawl (Table 4.7.4-2). Fishing with a dredge accounted for the greatest average annual revenue (\$6,078,125) and landings (11,729,188 pounds) from along the SRWEC fisheries study corridor, followed by bottom-trawl fishing (\$2,000,054 and 1,924,041 pounds). Top species in terms of revenue were scallops, monkfish, quahogs, squid, flounders skate wings, scup, Atlantic herring, and American lobster. The scallop fishery accounted for the greatest average annual revenue from landings along the SRWEC fisheries study corridor (\$5,366,174), followed by landings of monkfish (\$885,498), quahog (\$849,674), and squid (\$676,904). The top states reported by federally permitted vessels for revenue sourced from within the SRWEC fisheries study corridor were Massachusetts, New York, Rhode Island, New Jersey, and Connecticut. The greatest average annual revenue generated by federally permitted vessels fishing along the SRWEC fisheries study corridor were from landings in Massachusetts (\$6,258,440), followed by New York (\$1,827,185) and Rhode Island (\$1,426,204).

Fisheries that had the most activity in the SRWEC–OCS and SRWEC–NYS fisheries study corridor included groundfish (large-mesh multispecies or northeast multispecies), Atlantic herring, pelagic species (herring/mackerel/squid), monkfish, surfclam/ocean quahog, sea scallop, and squid. A full list of the fisheries active around the SRWEC is provided in Appendix V. The SRWEC–OCS traverses an area of very-high to high-density vessel activity for surfclam/ocean quahog and monkfish upon exiting the SRWF (Appendix V).

Aquaculture lease sites occur in Great South Bay along the southern Long Island shoreline, 10.6 mi (17 km) west of the landfall for the SRWEC. This site cultivates oysters, clams, and seaweed. A smaller oyster aquaculture site is located in Moriches Bay, 4.3 mi (7 km) to the east of the SRWEC landfall. Distances from the ICW HDD to the western and eastern aquaculture sites are approximately 9 and 5.6 mi (14.5 and 9 km), respectively (Appendix V).

Table 4.7.4-3 Commercial Fisheries Most Active in the SRWEC–OCS and SRWEC–NYS with a 10-km-wide Fisheries Study Corridor

Location	Gears	Species	Landing State
SRWEC–OCS and SRWEC–NYS	Mobile Gears: Dredge Bottom trawl Mid-water trawl Dredge Fixed Gears: Gillnet Pot	Scallops Monkfish Quahogs Squid Flounders Skate wings Scup	Massachusetts New York Rhode Island New Jersey Connecticut
SOURCE: Federal VTR Data			

CONSTRUCTION AND OPERATIONS PLAN

Site Characterization and Assessment of Impacts – Socioeconomic Resources

4.7.4.2 Potential Impacts

Construction, O&M, and decommissioning activities associated with the SRWF and SRWEC have the potential to cause both direct and indirect impacts on commercial and recreational fisheries. As appropriate and feasible, best management practices (BMPs) will be implemented to minimize impacts on fisheries, as described in *the Guidelines for Providing Information on Fisheries Social and Economic Conditions for Renewable Energy Development on the Atlantic Outer Continental Shelf Pursuant to 30 CFR Part 585* (BOEM 2020). IPFs associated with the construction and O&M phases of the Project are identified on Figure 4.7.4-1 and described separately, by phase, for the SRWF and SRWEC in the following sections. For the decommissioning phase of the Project, impacts are anticipated to be similar to or less adverse than those described for construction; therefore, impacts from decommissioning are not addressed separately in this section, with one exception. The Project's introduction of complex habitat in the offshore environment may result in *beneficial* impacts to certain fisheries, which would then be reversed at the time of decommissioning. This potential reversal of beneficial effects is discussed briefly below. Onshore Facilities are not expected to have direct or indirect impacts on commercial and recreational fisheries; however, an inadvertent release of drilling fluid (which is comprised of bentonite, drilling additives, and water) during the routing of the Onshore Transmission Cable across the ICW via the ICW HDD (Section 3.0) could have limited impacts on commercial and recreational fisheries. To minimize the potential risks associated with an inadvertent drilling fluid return/release, Sunrise Wind will develop an Inadvertent Return Plan for the inadvertent release of drilling fluids prior to construction and will implement appropriate BMPs. Supporting information on impacts to commercial and recreational fisheries are also presented in further detail in Appendix V.

Potential impacts are characterized as direct or indirect and by Project phase. Anticipated impacts are characterized as short-term or long-term. Different IPFs may result in varying levels of impact on commercial and recreational fisheries. IPFs that could impact commercial and recreational fisheries include seafloor disturbance, sediment suspension and deposition, noise, EMF, discharges and releases, trash and debris, traffic, visible structures, and lighting and marking. Impacts that affect fishing activity are considered to be direct impacts and impacts on commercial and recreational fisheries that are mediated by impacts on fishery resources (i.e., targeted finfish and invertebrate species) are considered indirect.

CONSTRUCTION AND OPERATIONS PLAN

Site Characterization and Assessment of Impacts – Socioeconomic Resources

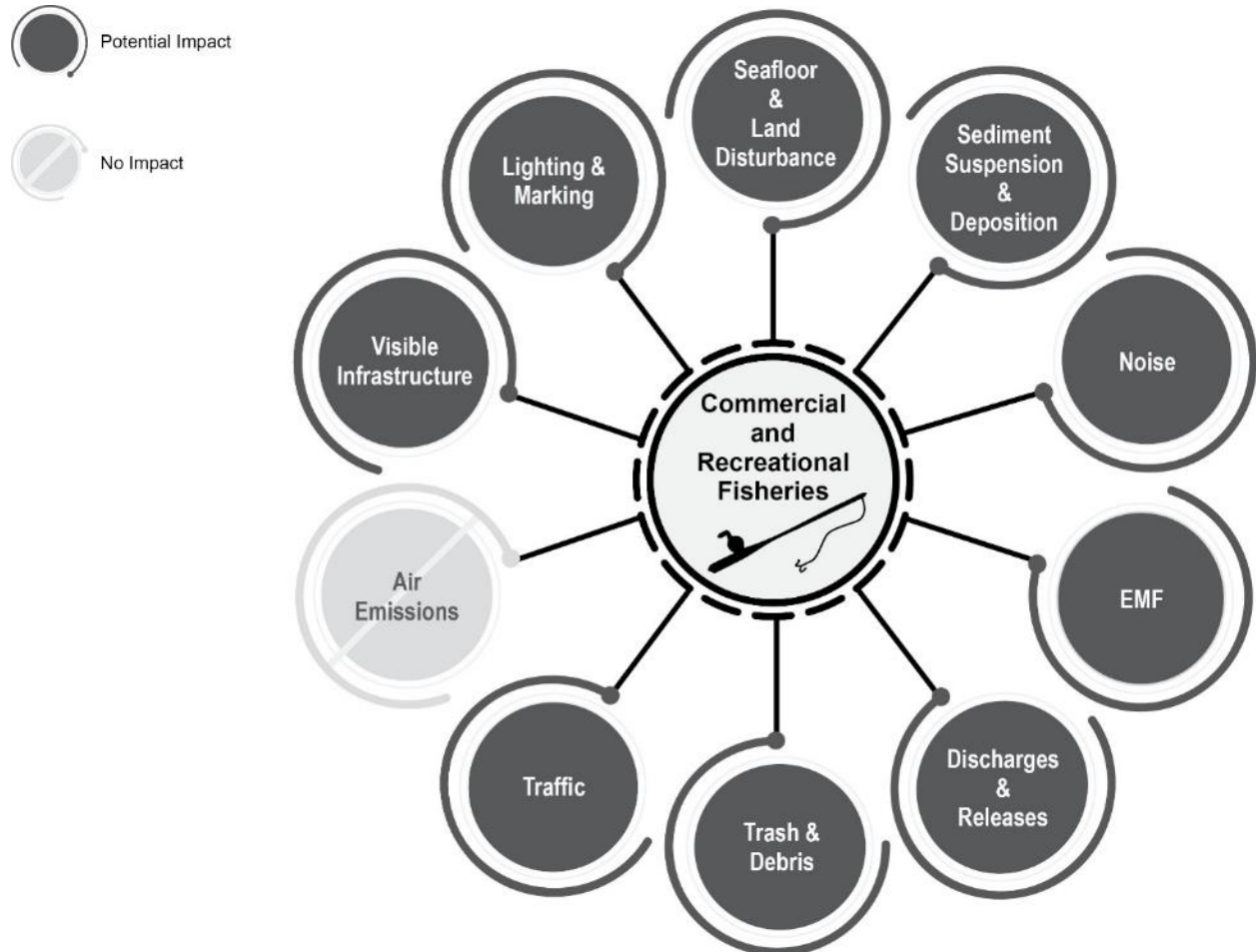

Figure 4.7.4-1 Impact-Producing Factors on Commercial and Recreational Fisheries

Sunrise Wind Farm

Construction activities are generally expected to have short-term impacts on access to fishing grounds because of an expected temporary maximum 500-yard (457-m)-radius safety zone established around locations where the SRWF components are being installed and effective/enforceable only when construction vessels are actually on site. Long-term impacts may occur due to habitat modification potentially causing effects to some commercially and recreationally targeted species and their prey.

O&M activities are expected to have short and long-term, direct and indirect impacts on commercial fisheries and may have beneficial long-term effects on recreational fisheries. It is likely that offshore structures will enhance, rather than diminish, recreational fishing opportunities in the SRWF. Increased structure in the SRWF may also enhance the availability of commercially and recreationally harvested species that inhabit hard bottom habitat (black sea bass, scup, hakes, cod, etc.). The foundations and scour protection may serve as artificial reef habitat when sessile benthic organisms and algae settle upon the surfaces. This typically happens rapidly as the materials used in these structures are completely benign.

CONSTRUCTION AND OPERATIONS PLAN

Site Characterization and Assessment of Impacts – Socioeconomic Resources

Similar to offshore petroleum platforms in the Gulf of Mexico, these structures will attract marine life, enhancing fisheries and contributing to recreational fishing. Adverse effects may include an increased risk of collision and entanglement or gear loss due to the presence of structures, as well as temporary restrictions on access to small Coast Guard-established safety zones around each structure and cable-laying vessel during construction activity. Safety zones may be established around O&M activities on a case-by-case basis in coordination with the USCG. IPFs that apply to the SRWF include seafloor and land disturbance, habitat alteration, sediment suspension and deposition, noise, EMF, discharges and releases, trash and debris, traffic, and visible structures. Additional details on potential impacts to commercial and recreational fisheries from the various IPFs at the SRWF are described below and in Appendix V.

Activities and tasks that will be undertaken by Sunrise Wind to reduce negative impacts of the Project on commercial and recreational fisheries, include maintaining a dedicated web page for mariners that posts schedules of construction and maintenance activities, sharing the Orsted US Offshore Wind Fisheries Gear Loss Prevention & Claim Procedure, and soliciting input from the fishing industry via surveys, workshops, one-on-one meetings, and other forums (*Fisheries Communication and Outreach Plan*, Appendix B, and *Fisheries Mitigation Plan for Sunrise Wind* [Sunrise Wind 2019]).

Construction

Seafloor Disturbance and Land Disturbance

Seafloor preparation, impact pile driving and/or vibratory pile driving/foundation installation, IAC installation, and vessel anchoring during construction and may result in short-term disruption of access to fishing areas for commercial and recreational fisheries. Fishing activity may be temporarily restricted within the safety zone established around construction operations. This restriction may result in a direct, short-term, impact on commercial and recreational fisheries as fishing activities temporarily relocate to avoid construction areas.

Indirect impacts on fisheries may occur as a result of the impacts of seafloor preparation (e.g., boulder removal, sand wave leveling, PLGR), impact pile driving and/or vibratory pile driving/foundation installation, IAC installation, and vessel anchoring on fishery resources. Impacts on fishery resources associated with these activities will primarily be associated with species that have benthic/demersal life stages and prefer the types of habitats that will be disturbed by seafloor preparation (Sections 4.4.2 and 4.4.3). These activities could cause injury or mortality to benthic/demersal species. Impacts are expected to be short-term as the effects will cease after seafloor preparation is completed in a given area, and minimal as they will disturb a small portion of the available habitat in the area. Impacts on fishery resources that have pelagic early and/or later life stages are expected to be negligible, as pelagic habitats will not be directly affected by seafloor preparation. However, these species may temporarily vacate the area of disturbance.

CONSTRUCTION AND OPERATIONS PLAN

Site Characterization and Assessment of Impacts – Socioeconomic Resources

In areas of sediment disturbance, demersal/benthic habitat recovery and benthic infaunal and epifaunal species abundances may take up to one to three years to recover to pre-impact levels, based on the results of a number of studies on benthic recovery (e.g., AKRF, Inc. et al. 2012; Germano et al. 1994; Kenny and Rees 1994; Wilber and Clarke 1998). Recolonization of sediments by epifaunal and infaunal species and the return of mobile fish and invertebrate species will allow this area to continue to serve as foraging habitat. Pelagic species/life stages may be indirectly affected by the temporary reduction of benthic forage species, but these impacts are expected to be negligible given the availability of similar habitats in the area. These habitat alterations and recovery time periods would result in a limited, long-term loss of productivity in the disturbed area and a subsequent indirect, long-term impact on commercial and recreational fisheries.

Sediment Suspension and Deposition

Seafloor-disturbing activities will result in temporary increases in sediment suspension and deposition and may result in indirect and short-term impacts on commercial and recreational fisheries due to impacts on fishery species that have preferred habitat in the SRWF. Potential sedimentation impacts to demersal eggs and larvae are assessed in Section 4.4.3.

A hydrodynamic and sediment transport modeling study was performed to inform evaluation of potential sediment suspension and deposition impacts associated with the Project (Appendix H). The modeling was performed using the PTM in the Surface-Water Modeling System. The PTM is a two-dimensional Lagrangian particle tracking model developed by the CIRP and the DOER at the USACE Research and Development Center. The model, inputs, and results are described in detail in Appendix H, and results are further summarized in Table 4.4.2-2.

Several model simulations were run to evaluate the concentrations of suspended sediments, spatial extent and duration of sediment plumes, and the seafloor deposition resulting from cable burial, HDD exit pit dredging, and other Project activities. The grain size distributions used for modeling were based on core sampling collected from May 17 to August 23, 2020 in support of the Project.

For the IAC, two representative segments of installation by jet plow were simulated and the modeling results indicate that sediment plumes with TSS concentrations exceeding the ambient conditions by 100 mg/L could extend up to 3,346 ft (1,020 m) from the cable corridor centerline. The model estimated that the elevated TSS concentrations would be of short duration and are expected to return to ambient conditions within 0.5 hours following the cessation of cable burial activities. The modeling results also indicate that sedimentation from IAC burial is expected to exceed 0.4 in (10 mm) of deposition a maximum of 220 ft (67 m) from the cable centerline covering an area of 3.0 ha (7.4 acres) of the seafloor, and the TSS plume is predicted to be primarily contained within the lower portion of the water column, approximately 12.8 ft (3.9 m) above the seafloor. Increases in sediment suspension and deposition associated with construction may cause short-term, limited impacts on benthic species and species with limited mobility and are not expected to have measurable impacts on pelagic species. Commercial fisheries that target species affected by sediment suspension and deposition may experience indirect, short-term, impacts due to losses in productivity.

CONSTRUCTION AND OPERATIONS PLAN

Site Characterization and Assessment of Impacts – Socioeconomic Resources

Noise

To evaluate the levels of underwater noise likely to be generated during construction, modeling was conducted that combined source modeling with spatial and temporal environmental context (e.g., location, oceanographic conditions, and seabed type) to estimate acoustic sound fields. Results of the acoustic modeling of impact pile driving activities are presented as single-strike ranges to a series of nominal SPL, SEL, and PK acoustic thresholds. For fish with swim bladders not involved in hearing, Popper et al. (2014) determined mortality and potential injury to occur at received sound levels greater than 210 dB SEL_{24h} or greater than 207 PK while recoverable injury is expected to occur at levels greater than 203 dB SEL_{24h} or greater than 207 dB Lpk, PK. Recoverable impairment of finfish is expected to occur at levels of greater than 186 dB SEL_{24h}. For assessing potential behavioral impacts on fish, GARFO (2016) uses a 150 dB SPL threshold for all species.

Short-term, indirect impacts on commercial and recreational fisheries could occur due to avoidance behavior of fishery resources caused by impact pile driving and/or vibratory pile driving noise, vessel noise, construction equipment noise, and/or aircraft noise impacts on fishery resources. Impact pile driving and/or vibratory pile driving noise may temporarily reduce habitat quality, result in behavioral changes, cause mobile species to temporarily vacate the area, or cause direct injury or mortality. As a result, impact pile driving and/or vibratory pile driving noise impacts may result in short-term, indirect, limited impacts on fisheries. However, habitat suitability is expected to return to pre-pile driving conditions shortly after cessation of the pile driving activity.

Sounds created by mechanical/jet plows, vessels, or aircraft are continuous or non-impulsive sounds, which have different characteristics underwater and impacts on marine life. The noise from mechanical/jet plows is expected to be masked by louder sounds from vessels. The duration of construction equipment and vessel noise at a given location will be short, as the installation vessel will only be present for a short period at any given location along the cable route. Underwater noise associated with helicopters is generally brief as compared with the duration of audibility in the air (Richardson et al. 1995). Overall, impact pile driving and/or vibratory pile driving activities will be short in duration, and the noise generated by vessel and aircrafts will be similar to the range of noise from existing vessel and aircraft traffic in the region. These activities are not expected to substantially affect the existing underwater noise environment and noise impacts on commercial and recreational fisheries are expected to be indirect, short-term, limited impacts.

CONSTRUCTION AND OPERATIONS PLAN

Site Characterization and Assessment of Impacts – Socioeconomic Resources

Discharges and Releases

Project-related marine vessels operating during construction will be required to comply with regulatory requirements for management of onboard fluids and fuels, including prevention and control of discharges. Trained, licensed vessel operators will adhere to navigational rules and regulations, and vessels will be equipped with spill containment and cleanup materials. Additionally, Sunrise Wind will comply with applicable international (IMO MARPOL), federal (USCG), and state (NY) regulations and standards for reporting treatment and disposal of solid and liquid wastes generated during all phases of the Project. As described in Appendix E1 – *Emergency Response Plan / Oil Spill Response Plan*, some liquid wastes will be permitted as discharge into marine waters (i.e., domestic water, deck drainage, treated sump drainage, uncontaminated ballast water, and uncontaminated bilge water); these are not expected to pose an adverse impact to marine resources as they will quickly disperse, dilute, and biodegrade (BOEM 2013).

All vessels will similarly comply with USCG standards regarding ballast and bilge water management. Liquid wastes from vessels (including sewage, chemicals, solvents, and oils and greases from equipment) will be properly stored, and disposal will occur at a licensed receiving facility. As required by 30 CFR 585.626, chemicals to be utilized during the Project are provided in Appendix E1, and in Table 3.3.1-2 and Table 3.3.6-2. Any unanticipated discharges or releases are expected to result in minimal, temporary impacts; activities are heavily regulated and unpermitted discharges are considered accidental events that are unlikely to occur. In the unlikely event that a reportable spill were to occur, the National Response Center would be notified, followed by the EPA, BOEM, and USCG, as outlined in Appendix E1.

Trash and Debris

Any active vessel operating within a marine environment has the potential to create trash and debris. However, the discharge or disposal of solid debris into offshore waters from OCS structures and vessels is prohibited by BOEM (30 CFR 250.300) and the USCG (MARPOL, Annex V, Pub. L. 100-220 [101 Stat. 1458]). In accordance with applicable federal, state, and local laws, Sunrise Wind will implement comprehensive measures prior to and during Project construction activities to avoid, minimize, and mitigate impacts related to trash and debris disposal. All trash and debris will be properly stored on vessels for later disposal of on land at an appropriate facility per 30 CFR 585.626(b)(9). Trash and debris will be contained on vessels and offloaded at port or construction staging areas. Food waste that has been ground and can pass through a 25-mm mesh screen may be disposed of according to 33 CFR 151.51-77. All other trash and debris returned to shore will be disposed of or recycled at licensed waste management and/or recycling facilities. Disposal of any other form of solid waste or debris in the water will be prohibited, and good housekeeping practices will be implemented to minimize trash and debris in vessel work areas. These practices will include orderly storage of tools, equipment, and materials, as well as proper waste collection, storage, and disposal to keep work areas clean and minimize potential environmental impacts. With proper waste management procedures, the potential for trash or debris to be inadvertently left overboard or introduced into the marine environment is not anticipated.

CONSTRUCTION AND OPERATIONS PLAN

Site Characterization and Assessment of Impacts – Socioeconomic Resources

Traffic

Commercial and recreational fisheries may experience direct, short-term, limited impacts due to increased vessel traffic during the construction phases of the SRWF as fishermen may avoid areas of increased vessel activity. Potential impacts on navigation are discussed in the NSRA, Appendix X. Sunrise Wind is committed to keeping the fishing industry informed about the construction schedule and related activities. To coordinate with all mariners, a Marine Coordination Center (MCC) will be used to reduce stakeholder concerns during the construction phase of the Project. Radio communications, vessel traffic and electronic monitoring, and informational notices will be coordinated through the MCC. Additional information regarding communication during construction is provided in the Appendix B.

Visible Infrastructures

The physical presence of installation vessels and SRWF components may affect fishing activity because there will be a safety zone around installation vessels and locations where the SRWF components are being installed. This temporary restricted area will consist of a maximum 500-yard (457-m)-safety zone and, therefore, access to fishing within this zone may be restricted. These impacts are expected to be direct, short-term, and limited.

Lighting and Marking

The schedule for construction of offshore structures is detailed in Section 3.2.2. During construction, the appropriate lighting and marking of each structure will be installed and activated as the structures are gradually put into place; therefore, lighting within the SRWF will increase as construction of the Project progresses. Additionally, all construction vessels will be subject to these rules for lighting/marking in the event that construction occurs at night. Lighting associated with construction vessels will be temporary at the SRWF. Sunrise Wind is supporting efforts to gather feedback from the fishing industry related to lighting and marking that will be provided to the USCG to consider when setting standards.

The response of finfish species to artificial lights is highly variable and depends on several factors such as the species, life stage, and the intensity of the light (reviewed in Section 4.4.3). The extent to which lighting on the OCS-DC, WTGs, and vessels affects the distribution of fishery species or their prey may result in short-term, limited impacts to commercial and recreational fisheries during construction.

Operations and Maintenance

Seafloor Disturbance and Land Disturbance

Seafloor disturbance during O&M of the SRWF will be limited to non-routine maintenance of bottom-founded infrastructure (e.g., foundations, scour protection, cable protection). These maintenance activities, and associated vessel anchoring, may result in direct, short-term impacts on fishing activity as fishing access would be temporarily disrupted. However, the extent of the disturbance would be temporary and limited to specific areas and, therefore, considered minimal. Vessels are not expected to anchor during O&M activities unless the cables or WTGs require maintenance.

CONSTRUCTION AND OPERATIONS PLAN

Site Characterization and Assessment of Impacts – Socioeconomic Resources

Seafloor-disturbing maintenance activities are expected to result in similar indirect, short-term, minimal impacts on fisheries as those discussed for the construction phase, as fishery resources would be temporarily affected. However, the extent of disturbance would be limited to specific areas, and impacts are expected to be limited.

Minimal impacts on commercial and recreational fisheries are expected from operation of the IAC themselves as they will be buried beneath the seabed. Sunrise Wind will determine, through a Cable Burial Risk Assessment informed by engagement with regulators and stakeholders (including commercial fisheries stakeholders), the appropriate target burial depth for submarine cables based on extensive assessment of seabed conditions and activity (including fishing) in the area. The target burial depth accounts for seabed mobility and the risk of interaction with external hazards such as fishing gear and vessel anchors while also considering other factors such as maintained navigational channels. The location of the SRWEC and associated cable protection will be provided to NOAA's Office of Coast Survey after installation is completed so that it may be marked on nautical charts.

In areas where burial might be hindered by seabed conditions (e.g., boulder fields, glacial moraines, shallow or surficial hardbottom or ledge, and existing cable crossings), target burial depth may not be achieved, and cable protection may be required. It is anticipated that cable protection (i.e., rock berms or mattresses) will have minimal impact to the existing fisheries regime as areas where the seabed dictates cable protection are often found in proximity to other natural snags and, therefore, are not likely trawled or dredged. Concrete mattresses, rock berms, and other cable burial remediation techniques, when applied, will be of the type that minimizes the potential for gear snags, as feasible. Fixed gear fishing around such deployments may continue as normal or with the benefit of additional seabed structure. In fished areas where the substrate type necessitates additional cable protection, it is possible that commercial dredgers and trawlers (e.g., surfclam/ocean quahog and scallop fisheries) potentially may lose a small amount of fishing ground in association with the altered seabed structure.

Presence of the foundations, associated scour protection, and cable protection may result in both negative and beneficial effects on commercial and recreational fisheries due to conversion of primarily soft bottom habitat to hard bottom habitat and the subsequent effects on fishery resources. Fishery resources associated with soft bottom habitats may experience long-term impacts, as available habitat will be slightly reduced. Fishery resources that inhabit hard bottom habitats may experience a beneficial effect, depending on the quality and type of habitat created by the foundations, scour protection, and cable protection, and the quality and type of the benthic community that colonizes that habitat. Commercial fisheries that target species with limited mobility may have indirect, long-term, impacts from the presence of the foundations (due to the impact on benthic and demersal species such as quahogs and scallops). A beneficial effect of the structures' physical presence is that the new structures may attract commercially and recreationally important species. During operations, the physical presence of these structures may result in benefits to commercial and recreational fishermen due to the WTG marking the location with a hardened structure and attracting fish. While identifying productive fishing destinations is a potentially beneficial effect of the SRWF for the greater recreational and commercial fishing population, it also may be considered a negative impact for those individual recreational and commercial fishermen who previously utilized the area as a secluded fishing location.

CONSTRUCTION AND OPERATIONS PLAN

Site Characterization and Assessment of Impacts – Socioeconomic Resources

In addition, increased fishing pressure on fish aggregations at the structures may result in increased mortality rates of the fisheries. If these circumstances arise, then indirect, long-term, limited impacts are expected.

Sediment Suspension and Deposition

Increases in sediment suspension and deposition during the O&M phase may result from vessel anchoring and non-routine maintenance activities that require exposing the IAC. Indirect, short-term, limited impacts on commercial and recreational fisheries resulting from sediment suspension and deposition during the O&M phase are expected to be similar to those discussed for the construction phase but on a much more limited spatial scale. A hydrodynamic and sediment transport modeling study was performed to inform evaluation of potential sediment suspension and deposition impacts associated with the Project (Appendix H).

Noise

Impacts on commercial and recreational fisheries from geophysical surveys and vessel and aircraft noise during O&M of the SRWF are expected to be similar to but of a lesser extent than those discussed for the construction phase. The noise generated by vessels and aircraft will be similar to the range of noise from existing vessel and aircraft traffic in the region and is not expected to substantially affect the existing underwater noise environment.

The underwater noise levels produced by the WTGs are expected to be within the hearing ranges of fish (Cheesman 2016; HDR 2019). Depending on the noise intensity, these noises could cause avoidance of the SRWF area for some fishery species or their prey. However, noise levels from operation of the SRWF WTGs are not expected to result in injury or mortality, and finfish may become habituated to the operational noise (Bergström et al. 2014; Thomsen et al. 2006). Lindeboom et al. (2011) found no difference in the residency times of juvenile cod around monopiles between periods of WTG operation or when WTGs were out-of-order. This study also found that sand eels did not avoid the wind farm. In a similar study, the abundance of cod, eel, shorthorn sculpin, and goldsinny wrasse, were found to be higher near WTGs, suggesting that potential noise impacts from operation did not override the attraction of these species to the artificial reef habitat (Bergström et al. 2013). Based on the available literature, operational noise from the WTGs is expected to have an indirect, long-term, but limited impact on commercial and recreational fisheries.

Electric and Magnetic Fields

The EMF surrounding AC cables, such as the IAC, will oscillate with a frequency of 60 Hz like all wiring and equipment connected to the electrical system. The magnetic field will be strongest at the surface of the cable and will decrease rapidly with distance from the cables. An electric field is created by the voltage applied to the conductors within the cable, but this electric field is shielded from the marine environment by grounded metallic sheaths and steel armoring around the cable. However, the oscillating nature of the 60 Hz magnetic field will induce a weak electric field around the cable that, similar to the magnetic field, will vary in strength based on the flow of electricity along the cable. An EMF assessment in the marine environment was conducted in support of the Project (Appendix J1). Though multiple cables come into the OCS-DC, the cables are sufficiently distributed that the level of EMF emissions at these structures is similar to the individual cables themselves (see Appendix J1 for more details).

CONSTRUCTION AND OPERATIONS PLAN

Site Characterization and Assessment of Impacts – Socioeconomic Resources

Appendix J1 also summarizes data from field studies conducted to assess impacts of EMF on marine organisms. These studies constitute the best source of evidence to assess the potential impacts on finfish and invertebrate behavior or distribution in the presence of energized cables. There will be no EMF emissions from the OCS–DC itself; however, several cables come into this structure and the cables will emit EMF when energized. Therefore, potential EMF impacts within the SRWF would be associated with AC EMF emissions of the IAC.

A comprehensive review of the ecological impacts of marine renewable energy projects determined that there has been no evidence demonstrating that EMF at the levels expected from marine renewable energy projects will cause an effect (adverse or beneficial) on demersal species (Copping et al. 2016). Moreover, a 2019 BOEM report that assessed the potential for AC EMF from offshore wind facilities to affect marine populations concluded that, for the SNE area, no negative effects are expected for populations of key commercial and recreational fish species (Snyder et al. 2019).

Discharges and Releases

Impacts from accidental discharges and releases during O&M are expected to be similar to, but of lesser likelihood than during construction, as there will be fewer Project-related marine vessels during this phase, and regulatory requirements and preventative measures will still apply. Unpermitted discharges or releases are considered accidental events, and in their unlikely occurrence, these are expected to result in minimal, temporary impacts. Permitted discharges are not expected to pose an adverse impact to marine resources as they will quickly disperse, dilute, and biodegrade (BOEM 2013).

Additionally, seawater cooling will be needed for the OCS–DC (Section 3.3.6.1). During operation, the OCS–DC will require continuous cooling water withdrawals and subsequent discharge of heated effluent back to the receiving waters. The maximum DIF and discharge volume is 8.1 million gallons per day with AIF and discharge volumes that are dependent on ambient source water temperature and facility output. Preliminary hydrodynamic modelling indicates that there will be some highly localized increases in water temperature in the immediate vicinity of the discharge location of the OCS–DC. The design, configuration, and operation of the CWIS for the OCS–DC will be permitted as part of an individual NPDES permit and additional details will be included in the permit application submitted to the EPA. This will include final results of the hydrodynamic modelling.

Trash and Debris

Impacts from marine disposal of trash and debris during O&M are expected to be similar to, but of lesser likelihood than during construction, as there will be fewer Project-related marine vessels during this phase, and regulatory requirements and preventative measures will still apply. The unanticipated marine disposal of trash and debris is considered an unpermitted, accidental event, and containment and good housekeeping practices will be implemented to minimize the potential.

Traffic

Impacts associated with traffic during O&M are expected to be similar to, but less frequent than, those discussed in the construction phase.

CONSTRUCTION AND OPERATIONS PLAN

Site Characterization and Assessment of Impacts – Socioeconomic Resources

Visible Infrastructures

Once the Project is constructed, the visible structures will be the WTGs and OCS–DC. Transportation and Navigation are specifically evaluated in the NSRA (Appendix X). Sunrise Wind has committed to an indicative layout scenario with WTGs and the OCS–DC sited in a uniform east-west/north-south grid with 1.15 by 1.15-mi (1 by 1-nm; 1.85 by 1.85-km) spacing that aligns with other proposed adjacent offshore wind projects in the RI-MA WEA and MA WEA. A major consideration for this proposed layout was the accommodation of fishing activity within and transit through the Project Area once WTGs are constructed. The design history for this layout and the alternative layouts considered are described in Section 2.0.

The USCG's stated policy is that "in the United States vessels will have the freedom to navigate through [wind farms], including export cable routes." (See USCG Navigation and Vessel Inspection Circular 01-19 dated 1 August 2019). Therefore, commercial fishermen will have the freedom to continue to fish within the SRWF and near cable routes. The WTGs and OCS–DC will be sited in a uniform east-west/north-south grid with 1.15 by 1.15-mi (1 by 1-nm; 1.85 by 1.85-km) spacing, which allows for safe navigation by fishing vessels; therefore, potential impacts on fishing grounds are considered direct, long-term, and minimal. In the event of gear interactions within the Project Area, there are draft guidelines that include an Orsted US Offshore Wind Fisheries Gear Loss Prevention & Claim Procedure available in the Appendix B, on the Orsted website, and provided to fishery liaisons.

The physical presence of O&M vessels and SRWF components may affect fishing activity because there may be a safety perimeter around certain O&M activities on a case-by-case basis in coordination with the USCG. If necessary, this temporarily safety zone may consist of a maximum 500-yard (457-m)-radius safety zone.

Lighting and Marking

As detailed in Sections 3.3.6, 3.3.8, 3.5.7 and 4.8.1, WTGs and OCS–DC will be lit and marked in accordance with FAA, USCG, and BOEM requirements for aviation and navigation. Navigation lights, markings, sound signals, and other aids-to-navigation will be installed and maintained as prescribed within the PATON permit issued by the USCG for each operating WTG and OCS–DC. Sunrise Wind is supporting efforts to gather feedback from the fishing industry related to lighting and marking that will be provided to the USCG to consider when setting standards (NSRA, Appendix X). Sunrise Wind may also install AIS on select WTGs.

The response of finfish species to artificial lights is highly variable and depends on several factors such as the species, life stage, and the intensity of the light (reviewed in Section 4.4.3). The extent to which lighting on the OCS–DC, WTGs, and vessels affects the distribution of fishery species or their prey may result in limited impacts to commercial and recreational fisheries during O&M.

CONSTRUCTION AND OPERATIONS PLAN

Site Characterization and Assessment of Impacts – Socioeconomic Resources

Decommissioning

At the end of the Project's operational life, structures will be decommissioned in accordance with a detailed Project decommissioning plan that will be developed in compliance with applicable laws, regulations, and BMPs at that time. All facilities will need to be removed to a depth of 15 ft (4.6 m) below the mudline, unless otherwise authorized by BOEM (30 CFR § 585.910(a)). This plan will account for changing circumstances during the operational phase of the Project and will reflect new discoveries particularly in the areas of marine environment, technological change, and any relevant amended legislation. Absent permission from BOEM, Sunrise Wind will complete decommissioning within two years of termination of the Lease.

If the man-made structures are to be removed at the end of the Project's operational life, as currently prescribed, this will reverse the potential beneficial impacts that the structures' physical presence may have (i.e., via attraction) on commercially and recreationally important species. Over time, the disturbed area is expected to revert to pre-construction conditions, which would result in a beneficial impact for fishery resources associated with soft bottom habitats. Overall, habitat alteration from decommissioning is expected to cause minimal impacts because similar hard bottom habitat is already present in and around the SRWF and SRWEC (Appendices M1, M2, and M3).

A recent review on the impacts of decommissioning man-made structures provides the case for considering alternatives to a mandated complete removal of all man-made structures. The paper emphasizes the potential importance of man-made submerged structures as complex habitats potentially supporting a rich localized food web (Fortune and Paterson 2020). Benthic habitat and fish and invertebrate monitoring at the foundations and within the surrounding area will document the direct realized effects of these novel hard surfaces on benthic and water column resources, and the subsequent effects on fishery resources. Documenting the established epifaunal community that will inhabit the foundations, as well as the infaunal community at the base of these structures, will provide information on the habitat value, including its value as a resource for commercial and recreational fishers. The data gathered from these post-construction surveys will be used to inform decommissioning strategies in the future.

Sunrise Wind Export Cable–OCS

SRWEC–OCS installation activities are generally expected to have short-term, localized impacts because of temporary restrictions on entering a small safety zone encircling installation vessels (Appendix V), and because of habitat modification that may affect some commercially and recreationally targeted species and their prey. Safety zones may be established around O&M activities on a case-by-case basis in coordination with the USCG. O&M activities are expected to have long-term, limited impacts on commercial fisheries and may have limited impacts on recreational fisheries. The following IPFs apply to the SRWEC–OCS: seafloor and land disturbance, sediment suspension and deposition, noise, discharges and releases, trash and debris, and traffic. Additional details on potential impacts on commercial and recreational fisheries from the various IPFs are described in the following sections.

CONSTRUCTION AND OPERATIONS PLAN

Site Characterization and Assessment of Impacts – Socioeconomic Resources

Construction

Seafloor Disturbance and Land Disturbance

As discussed for construction of the SRWF, the potential direct, short-term, limited impacts on commercial and recreational fisheries from seafloor preparation for the SRWEC–OCS are primarily associated with temporary disruption of access to fishing areas for commercial and recreational fisheries. In federal waters, the top fisheries in terms of revenue and landings use dredge, bottom trawls, gillnets, and mid-water trawls. Quahogs, and Atlantic herring are the highest landed species by pound. Vessel intensity for the Atlantic herring, monkfish, surfclam/ocean quahog, scallop, and squid fisheries was medium-high to very high along portions of the SRWEC–OCS route; therefore, these fisheries are most likely to be affected by seafloor disturbance for the SRWEC–OCS. Impacts on commercial and recreational fisheries associated with SRWEC installation and vessel anchoring are expected to result in similar indirect, short-term, limited impacts as those discussed for the SRWF IAC.

In areas of sediment disturbance, demersal/benthic habitat recovery and benthic infaunal and epifaunal species abundances may take up to one to three years to recover to pre-impact levels, based on the results of a number of studies on benthic recovery (e.g., AKRF, Inc. et al. 2012; Germano et al. 1994; Kenny and Rees 1994; Wilber and Clarke 1998). Recolonization of sediments by epifaunal and infaunal species and the return of mobile fish and invertebrate species will allow this area to continue to serve as foraging habitat. Pelagic species/life stages may be indirectly affected by the temporary reduction of benthic forage species, but these impacts are expected to be limited given the availability of similar habitats in the area. These habitat alterations and recovery time periods would result in a limited, long-term loss of productivity in the disturbed area and a subsequent indirect, long-term, limited impact on commercial and recreational fisheries.

Sediment Suspension and Deposition

Seafloor-disturbing activities associated with installation of the SRWEC–OCS will result in temporary increases in sediment suspension and deposition. Sediment transport modeling for the Project was performed by using the PTM in the Surface-Water Modeling System. The PTM to evaluate the concentrations of suspended sediments, spatial extent and duration of sediment plumes, and the seafloor deposition resulting from construction activities. The sediment transport modeling results are summarized in Table 4.4.2-2. The model, inputs, and results are described in detail in Appendix H.

For the SRWEC–OCS, modeling results indicate that sediment plumes with TSS concentrations exceeding the ambient conditions by 100 mg/L could extend up to 2,969 ft (905 m) from the cable corridor centerline in federal waters. The model estimated that the elevated TSS concentrations would be of short duration and expected to return to ambient conditions within 0.4 hours following the cessation of cable burial activities. Sedimentation from SRWEC–OCS burial is predicted to exceed 0.4 in (10 mm) of deposition up to 791 ft (241 m) from the cable corridor centerline. This thickness of sedimentation is expected to cover approximately 832.3 acres (337 ha) in federal waters, and the TSS plume is predicted to be primarily contained within the lower portion of the water column, approximately 9.8 ft (3.0 m) above the seafloor.

CONSTRUCTION AND OPERATIONS PLAN

Site Characterization and Assessment of Impacts – Socioeconomic Resources

Increases in sediment suspension and deposition associated with construction may cause short-term, limited impacts on benthic species and species with limited mobility, and are not expected to have measurable impacts on pelagic species. Commercial fisheries that target species affected by sediment suspension and deposition may experience indirect, short-term, limited impacts due to losses in productivity.

Noise

Impacts on commercial and recreational fisheries resulting from vessel, construction equipment, and aircraft noise during construction of the SRWEC–OCS are expected to be indirect, short-term, and limited, and similar to those discussed for construction of the SRWF IAC.

Discharges and Releases

Impacts associated with wastewater discharge or an inadvertent release of hazardous material during construction of the SRWEC–OCS are expected to be similar to those discussed for the SRWF.

Trash and Debris

Impacts associated with trash and debris are expected to be similar to those discussed for the SRWF.

Traffic

Direct impacts on commercial and recreational fisheries resulting from vessel traffic during SRWEC–OCS construction are expected to be direct and short-term and similar in magnitude to those discussed for the SRWF.

Operations and Maintenance

Seafloor Disturbance and Land Disturbance

Seafloor disturbance during O&M of the SRWEC–OCS will be limited to non-routine maintenance that may require uncovering and reburial of the cables as well as maintenance of cable protection. These maintenance activities, and associated vessel anchoring, may result in direct, short-term, limited impacts on fishing activity, as fishing access would be temporarily disrupted. However, the extent of the disturbance would be limited to specific areas along the cable route. During O&M, anchoring will be limited to vessels required to be onsite for an extended duration.

Impacts on commercial and recreational fisheries associated with maintenance activities and vessel anchoring are expected to result in similar indirect, short-term impacts as those discussed for the SRWF IAC as fishery resources would be temporarily affected if benthic prey are disturbed; however, the extent of disturbance would be limited to specific areas.

Commercial and recreational fisheries are expected to experience limited impacts from the presence of the SRWEC–OCS because it will be buried beneath the seabed and measures will be taken to ensure appropriate burial depth as described for the O&M of the SRWF IAC above.

CONSTRUCTION AND OPERATIONS PLAN

Site Characterization and Assessment of Impacts – Socioeconomic Resources

The export cable corridor is engineered to minimize areas where burial might be hindered by seabed conditions including boulder fields, glacial moraines, shallow or surficial hardbottom or ledge, existing telecommunications cable crossings, and cable joints. However, in certain locations where target burial depth is not achieved, cable protection may be required. It is anticipated that cable protection (i.e., rock berms or mattresses) will have minimal impact to the existing fisheries regime, as areas where the seabed dictates cable protection are often found in proximity to other natural snags, and therefore are not likely trawled or dredged. In fished areas where the substrate type necessitates additional cable protection, it is possible that commercial dredgers and trawlers (e.g., surfclam/ocean quahog and scallop fisheries) potentially may lose a small amount of fishing ground in association with the altered seabed structure.

Concrete mattresses, rock berms, and other cable burial remediation techniques, when applied, will be of the type that minimizes the potential for gear snags, as feasible. Fixed gear fishing around such deployments may continue as normal or with the benefit of additional seabed structure. The location of the SRWEC and associated cable protection will be provided to NOAA's Office of Coast Survey after installation is completed so that they may be marked on nautical charts. In the event of fishing gear interactions within the Project Area, there are draft guidelines that include the Orsted US Offshore Wind Fisheries Gear Loss Prevention & Claim Procedure, which is part of the Appendix B, and is available on the Orsted website and provided to fishery liaisons.

As discussed for O&M for the SRWF IAC, the presence of the cable protection may result in both negative and beneficial indirect effects on commercial and recreational fisheries due to conversion of primarily soft bottom habitat to hard bottom habitat and the subsequent effects on fishery resources. The cable protection may have a long-term impact on fishery resources associated with soft bottom habitats and a long-term beneficial effect on species associated with hard bottom habitats, depending on the quality of the habitat created by the cable protection and the quality of the benthic community that colonizes that habitat. After recolonization, the cable protection locations may provide beneficial effects to commercial and recreational fisheries using fixed gear if they choose to target species that may favor these hard bottom habitats, depending on the quality and type of habitat created by the cable protection and the quality and type of benthic community that colonizes that habitat.

Sediment Suspension and Deposition

Increases in sediment suspension and deposition during the O&M phase will result from vessel anchoring and non-routine maintenance activities that require exposing portions of the SRWEC. Impacts on commercial and recreational fisheries resulting from sediment suspension and deposition during the O&M phase are expected to be similar to the indirect, short-term, impacts discussed for the O&M of the SRWF IAC.

Noise

Impacts from geophysical surveys and vessel and aircraft noise during O&M of the SRWEC–OCS are expected to be similar to, but less frequent than those described for the construction phase (Appendix I3).

CONSTRUCTION AND OPERATIONS PLAN

Site Characterization and Assessment of Impacts – Socioeconomic Resources

Electric and Magnetic Fields

Once the SRWEC–OCS becomes energized, the cables will produce a magnetic field that will decrease in strength rapidly with distance. The cable will be shielded and, where feasible, buried beneath the seafloor and will otherwise be protected. Submarine transmission cables do not directly emit electrical fields into surrounding areas but are surrounded by magnetic fields that can cause induced electrical fields in moving water (Gill et al. 2012). A modeling analysis of the magnetic fields and induced electric fields anticipated to be produced during operation of the SRWEC–OCS was performed, and results are included in Appendix J1. Appendix J1 also summarizes published data from field and laboratory studies conducted to assess impacts of EMF on marine organisms.

Small-scale behavioral changes in fish and crustacean have been observed near cables involving DC current (Hutchinson et al. 2018). Hutchison et al. (2018, 2020) assessed the responses of American lobster to a DC cable under field conditions and concluded that EMF resulted in minor changes in lobster distribution within the cages, although the cable was not observed to present a barrier to movement. At peak loading, the magnetic fields produced by the Project's DC cables at the overlying seabed are projected to be well below the levels detectable by finfish (Appendix J1). Based on this information, it is not expected that commercial or recreational fisheries will be measurably affected by EMF from the cables.

Discharges and Releases

Impacts associated with wastewater discharge or an inadvertent release of hazardous material during O&M of the SRWEC–OCS are expected to be similar to those discussed for the SRWF.

Trash and Debris

Impacts associated with marine trash and debris are expected to be similar to those discussed for the construction phase of the SRWF.

Traffic

Traffic during the O&M of the SRWEC–OCS is expected to have similar impacts on commercial and recreational fisheries as those described for the SRWF. During O&M, vessel traffic will be limited to routine maintenance visits and nonroutine maintenance as needed. Limited crew and supply runs using smaller support vessels will be required. Vessel traffic during O&M will be lower than during construction due to fewer operating vessels. Service operation vessels also will be in operation in the Project Area.

CONSTRUCTION AND OPERATIONS PLAN

Site Characterization and Assessment of Impacts – Socioeconomic Resources

Sunrise Wind Export Cable–NYS

Like the SRWEC–OCS, SRWEC–NYS cable installation activities are generally expected to have short-term, limited impacts because of temporary restrictions on entering a small zone encircling installation vessels (Appendix V), and because of habitat modification that may affect some commercially and recreationally targeted species and their prey. Safety zones may be established around O&M activities on a case-by-case basis in coordination with the USCG. O&M activities are expected to have direct, long-term, limited impacts on commercial fisheries and may have beneficial effects on recreational fisheries. The following IPFs apply to the SRWEC–NYS: seafloor and land disturbance, habitat alteration, sediment suspension and deposition, noise, discharges and releases, trash and debris, and traffic. Additional details on potential impacts on commercial and recreational fisheries from the various IPFs are described in the following sections.

Construction

Seafloor and Land Disturbance

As discussed for construction of the SRWEC–OCS, the potential direct, short-term, limited impacts on commercial and recreational fisheries from seafloor preparation for the SRWEC–NYS are primarily associated with temporary disruption of access to fishing areas for commercial and recreational fisheries. To support HDD installation, HDD exit pits will be excavated offshore within the surveyed corridor and outside the Fire Island National Seashore boundary. In NYS waters, vessel intensities for groundfish, pelagic species (herring/mackerel/squid), monkfish, and squid were very high or high along portions of the SRWEC–NYS route; therefore, these fisheries are most likely to be affected by seafloor preparation for the SRWEC–NYS.

Impacts on commercial and recreational fisheries associated with SRWEC–NYS installation and vessel anchoring are expected to result in similar indirect, short-term, limited impacts as those discussed for the SRWF IAC.

As discussed for the SRWEC–OCS, in areas of sediment disturbance, demersal/benthic habitat recovery and benthic infaunal and epifaunal species abundances may take up to one to three years to recover to pre-impact levels, based on the results of a number of studies on benthic recovery (e.g., AKRF, Inc. et al. 2012; Germano et al. 1994; Kenny and Rees 1994; Wilber and Clarke 1998). These habitat alterations and recovery time periods may result in a minimal, long-term loss of productivity in the disturbed area and a subsequent indirect, long-term, limited impact on commercial and recreational fisheries.

Sediment Suspension and Deposition

As discussed for the SRWEC–OCS, seafloor-disturbing activities associated with the SRWEC–NYS will also result in temporary increases in sediment suspension and deposition. Within the SRWEC–NYS corridor, HDD exit pits (one per HDD) would be dredged. Sediment transport modeling for the Project was performed by using the PTM to evaluate the concentrations of suspended sediments, spatial extent and duration of sediment plumes, and the seafloor deposition resulting from construction activities. The sediment transport modeling results are summarized in Table 4.4.2-2. The model, inputs, and results are described in detail in Appendix H.

CONSTRUCTION AND OPERATIONS PLAN

Site Characterization and Assessment of Impacts – Socioeconomic Resources

For the SRWEC–NYS, modeling results indicate that sediment plumes with TSS concentrations exceeding the ambient conditions by 100 mg/L could extend up to 2,969 ft (905 m) from the cable corridor centerline in federal waters. The model estimated that the elevated TSS concentrations would be of short duration and expected to return to ambient conditions within 0.4 hours following the cessation of cable burial activities. Sedimentation from SRWEC–OCS burial is predicted to exceed 0.4 in (10 mm) of deposition up to 791 ft (241 m) from the cable corridor centerline. This thickness of sedimentation is expected to cover approximately 832.3 acres (337 ha) in federal waters, and the TSS plume is predicted to be primarily contained within the lower portion of the water column, approximately 9.8 ft (3.0 m) above the seafloor.

Mechanical dredging of HDD exit pits is not expected to elevate TSS concentrations more than 100 mg/L above ambient conditions, and TSS concentrations are expected to return to ambient within 0.3 hours. Sedimentation from HDD exit pit dredging may exceed 0.4 in (10 mm) of deposition up to 79 ft (24 m) from the pit and cover approximately 0.25 acres (1,012 m²).

The TSS plume is predicted to be primarily contained within the lower portion of the water column, approximately 7.2 ft (2.2 m) above the seafloor.

For the majority of the SRWEC–NYS, increases in sediment suspension and deposition associated with construction may cause short-term, limited impacts on benthic species and species with limited mobility and are not expected to have measurable impacts on pelagic species. Commercial fisheries that target species affected by sediment suspension and deposition may experience indirect, short-term impacts due to losses in productivity.

Noise

Impacts on commercial and recreational fisheries resulting from vessel, construction equipment, and aircraft noise are expected to be indirect, short-term impacts and similar to those discussed for construction of the SRWEC–OCS and SRWF IAC.

Discharges and Releases

Impacts associated with wastewater discharge or an inadvertent release of hazardous material during construction of the SRWEC–NYS are expected to be similar to those discussed for the SRWF.

Additionally, HDD at landfall will use a drilling fluid that consists of bentonite, drilling additives, and water. A barge or jack-up vessel may also be used to assist the drilling process, handle the pipe for pull in, and help transport the drilling fluids and mud for treatment, disposal and/or reuse. To minimize the potential risks for an inadvertent drilling fluid release, an Inadvertent Return Plan will be developed and implemented during construction. Refer to Section 3.3.3.3 for additional details regarding HDD installation and the use of drilling fluids.

Trash and Debris

Impacts associated with marine trash and debris are expected to be similar to those discussed for the SRWF.

Traffic

Impacts on commercial and recreational fisheries resulting from vessel traffic during SRWEC–NYS construction are expected to be similar to those discussed for the SRWEC–OCS.

CONSTRUCTION AND OPERATIONS PLAN

Site Characterization and Assessment of Impacts – Socioeconomic Resources

Operations and Maintenance

Seafloor Disturbance and Land Disturbance

As discussed for the SRWEC–OCS, seafloor disturbance during O&M of the SRWEC–NYS will be limited to non-routine maintenance that may require uncovering and reburial of the cables as well as maintenance of cable protection where present. These maintenance activities and associated vessel anchoring are expected to result in similar direct, short-term, limited impacts on fishing activity as those discussed for the SRWEC–OCS.

Indirect impacts on commercial and recreational fisheries associated with maintenance activities and vessel anchoring are expected to result in similar short-term impacts as those discussed for the SRWEC–OCS, as fishery resources may be temporarily affected if benthic prey are disturbed; however, the extent of disturbance would be limited to specific areas.

Commercial and recreational fisheries are expected to experience limited impacts from the presence of the SRWEC–NYS because it will be buried beneath the seabed. The USCG's stated policy is that "in the United States vessels will have the freedom to navigate through (wind farms), including export cable routes." (See Coast Guard Navigation and Vessel Inspection Circular 01-19 dated 1 August 2019.) Therefore, commercial fishermen will have the freedom to continue to fish near the SRWEC–NYS.

Cable protection (e.g., concrete mattresses or rock berms) may be placed in select areas along the SRWEC–NYS. As discussed for operations and maintenance for the SRWEC–OCS, the presence of the cable protection may result in both negative and beneficial indirect effects on commercial and recreational fisheries due to conversion of primarily soft bottom habitat to hard bottom habitat and the subsequent effects on fishery resources. The cable protection may have a long-term impact on fishery resources associated with soft bottom habitats and a long-term beneficial effect on species associated with hard bottom habitats, depending on the quality of the habitat created by the cable protection and the quality of the benthic community that colonizes that habitat. After recolonization, the cable protection locations may provide beneficial effects to recreational fisheries if they choose to target recreational species that may favor these hard bottom habitats, depending on the quality and type of habitat created by the cable protection and the quality and type of benthic community that colonizes that habitat.

Sediment Suspension and Deposition

Increases in sediment suspension and deposition during the O&M phase will result from vessel anchoring and non-routine maintenance activities that require exposing portions of the SRWEC–NYS. Direct and indirect impacts on commercial and recreational fisheries resulting from sediment suspension and deposition during the O&M phase are expected to be similar to the short-term, limited impacts discussed for the SRWEC–OCS.

Noise

Impacts from geophysical surveys and vessel and aircraft noise during O&M of the SRWEC–NYS are expected to be similar to, but less frequent than those described for the construction phase (Appendix I3).

CONSTRUCTION AND OPERATIONS PLAN

Site Characterization and Assessment of Impacts – Socioeconomic Resources

Electric and Magnetic Fields

As discussed for the SRWEC–OCS, a modeling analysis of the magnetic fields and induced electric fields anticipated to be produced during operation of the SRWEC–NYS was performed and results are included in Appendix J1. Changes to fish and invertebrate abundances and distributions due to EMF are not expected. Moreover, a 2019 BOEM report that assessed the potential for AC EMF from offshore wind facilities to affect marine populations concluded that, for the SNE area, no negative effects are expected for populations of key commercial and recreational fish species (Snyder et al. 2019). Based on this information, it is not expected that fishery resources, and, thus, commercial and recreational fisheries, will be measurably affected by EMF from the cables.

Discharges and Releases

Impacts associated with wastewater discharge or an inadvertent release of hazardous material during O&M of the SRWEC–NYS are expected to be similar to those discussed for the SRWF.

Trash and Debris

Impacts associated with marine trash and debris are expected to be similar to those discussed for the construction phase of the SRWF.

Traffic

Traffic during the O&M of the SRWEC–NYS is expected to have similar impacts on commercial and recreational fisheries as those described for the SRWF.

4.7.4.3 Proposed Environmental Protection Measures

Sunrise Wind will implement the following environmental protection measures to reduce potential impacts on commercial and recreational fisheries. These measures are based on protocols and procedures successfully implemented for similar offshore projects.

- Sunrise Wind is committed to an indicative layout scenario with WTGs and the OCS–DC sited in a uniform east-west/north-south grid with 1.15 by 1.15-mi (1 by 1-nm; 1.85 by 1.85-km) spacing that aligns with other proposed adjacent offshore wind projects in the RI-MA WEA and MA WEA. This layout has been confirmed through expert analysis and the USCG (USCG 2020) to allow for safe navigation without the need for additional designated transit lanes. This layout will also provide a uniform, wide spacing among structures to facilitate search and rescue operations and is consistent with study recommendations in the USCG Massachusetts and Rhode Island Port Access Route Study (USCG 2020). Sunrise Wind is committed to collaborative science with the commercial and recreational fishing industries prior to, during, and following construction. Fisheries monitoring studies are being planned to assess the impacts associated with the Project on economically and ecologically important fisheries resources within the SRWF and along the SRWEC.

These studies will be conducted in collaboration with the local fishing industry and will build upon monitoring efforts being conducted by affiliates of Sunrise Wind at other wind farms in the region.

CONSTRUCTION AND OPERATIONS PLAN

Site Characterization and Assessment of Impacts – Socioeconomic Resources

- Sunrise Wind aims, where feasible, to mitigate and reduce potential impacts to fishing activities, as outlined in the *Fisheries Communication and Outreach Plan* (Appendix B), and the Fisheries Mitigation Plan for Sunrise Wind (Sunrise Wind 2019), which is available on the NYSERDA website and will be updated throughout Project development.
- The locations of the SRWF, SRWEC, IAC, and associated cable protections will be provided to NOAA's Office of Coast Survey after installation is completed so that they may be marked on nautical charts.
- To the extent feasible, installation of the SRWEC and IAC will occur using methods such as mechanical plow, jet plow, or mechanical cutter.
- To the extent feasible, the SRWEC IAC will typically target a burial depth of 3 to 7 ft (1 to 2 m). The target burial depth will be determined based on an assessment of seabed conditions, seabed mobility, the risk of interaction with external hazards such as fishing gear and vessel anchors, and a site-specific Cable Burial Risk Assessment. The cables include various protective armoring and sheathing to protect the cable from external damage and keep it watertight. Cable protection measures will be employed where cable burial depth is not adequate. As appropriate and feasible, BMPs will be implemented to minimize impacts on fisheries, as described in BOEM's *Guidelines for Providing Information on Fisheries for Renewable Energy Development on the Atlantic Outer Continental Shelf Pursuant to 30 CFR Part 585* (BOEM 2019).
- The WTGs will be lit and marked in accordance with FAA Advisory Circular 70/7460-1L (2018), as recommended by BOEM's *Guidelines for Lighting and Marking of Structures Supporting Renewable Energy Development* (BOEM 2021).
- The WTGs and OCS-DC will be lit and marked in accordance with BOEM and USCG requirements for aviation and navigation obstruction lighting, respectively.
- Navigation lights, markings, sound signals, and other aids to navigation (ATON) (including AIS on select WTGs) will be installed and maintained as prescribed within the Private Aids to Navigation (PATON) permit issued by the USCG for each WTG and the OCS-DC. Sunrise Wind will require all construction and O&M vessels to comply with applicable International Convention for the Prevention of Pollution from Ships (IMO MARPOL), federal (USCG and EPA), and state regulations and standards for the management, treatment, discharge, and disposal of onboard solid and liquid wastes and the prevention and control of spills and discharges.
- Accidental spill or release of oils or other hazardous materials will be managed offshore through an ERP/OSRP and onshore through an SPCC Plan.
- Project construction, O&M, and decommissioning activities will be coordinated with appropriate contacts at USCG and DoD command headquarters.

CONSTRUCTION AND OPERATIONS PLAN

Site Characterization and Assessment of Impacts – Socioeconomic Resources

- A comprehensive communication plan will be implemented during offshore construction to inform all mariners, including commercial and recreational fishing vessels, and recreational boaters, of construction activities and Project-related vessel movements. Communication will be facilitated through a Project website, public notices to mariners and vessel float plans, and a Fisheries Liaison. Sunrise Wind will submit information to the USCG to issue Local Notice to Mariners during offshore installation activities.

For information related to minimizing impacts to finfish and EFH resources, see Section 4.4.3, and for impacts to benthic and shellfish resources, see Section 4.4.2.

4.7.5 Other Marine Uses and Coastal Land Use

This section describes the affected environment and potential effects from the construction and operation of the Project as they relate to other marine uses and coastal land use in the primary ROI. The description of the affected environment and assessment of potential impacts were developed by reviewing current public data sources related to land use and zoning (e.g., Geographic Information Systems [GIS] data and Town of Brookhaven, NY land use and zoning map) and data sources for existing marine uses and infrastructure including NOAA nautical charts for the region and GIS websites published by the Northeast Ocean Data Portal Collaborative (Northeast Regional Ocean Council 2019) and the Mid-Atlantic Regional Council on the Ocean (MARCO 2020). A description of the other marine uses and coastal land use in the Project Area is provided below, followed by an evaluation of potential Project-related impacts.

4.7.5.1 Affected Environment

This section characterizes existing other marine uses and coastal land use within the vicinity of the various Project components based on publicly available land use and zoning data.

Existing and planned marine uses consist of ATONs, alternative energy facilities, anchorage areas, artificial reefs, passenger ferry routes, high-frequency (HF) radar locations, ocean disposal sites, sand borrow areas, military uses, offshore scientific assessments, pilot boarding areas, existing submarine cables and other cable areas, and MEC/UXO.

The following section provides a brief description of other marine uses that may exist in the vicinity of the Project Area.

Regional Overview – Other Marine Uses

In general, locations for Lease Areas were selected for offshore wind development based on extensive pre-screening conducted by BOEM. A primary objective of the pre-screening was to minimize conflicts with other marine uses. The screening utilized the wide array of data sources and marine spatial planning completed by both state governments and BOEM, including the OSAMP and the Massachusetts Ocean Management Plan. In addition, BOEM conducted extensive stakeholder outreach and public meetings to further define potential conflicts with other marine uses (and Orsted participated in those meetings). Other marine uses are defined below. Where present, these uses are shown on Figure 4.7.5-1 and are described further in Table 4.7.2-1.

V:\1956\active\Task Owner and other Non-BC1956_Jobs\2028113199\03_data\gis_cad\gis\mxd\COP\2028113199_4.7.5-1_OtherMarineUses.mxd Revised: 2021-06-03 By: gcarpentier

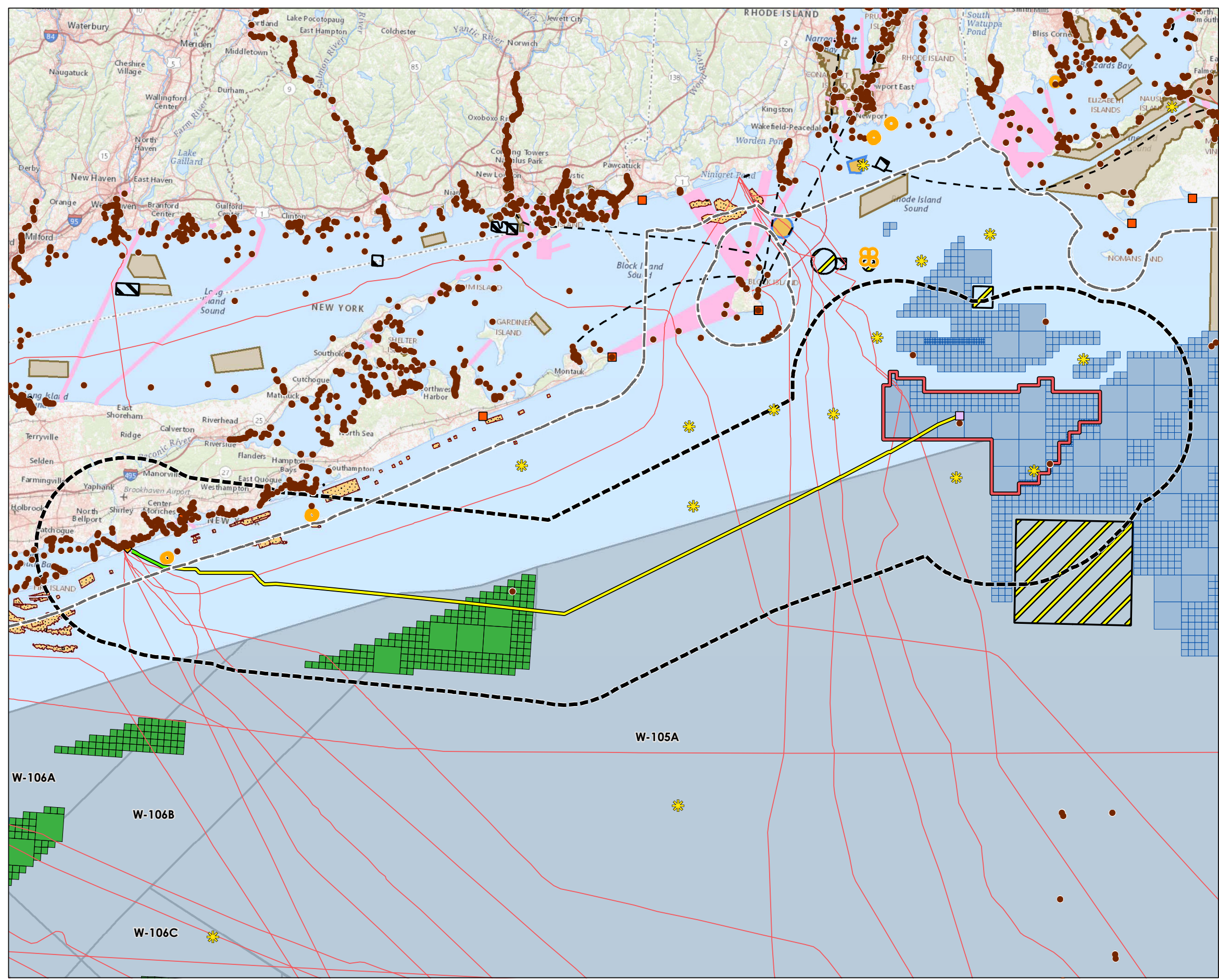

**Figure 4.7.5-1
Other Marine Uses**

Sunrise Wind | Powered by Ørsted & Eversource

Legend

- Sunrise Wind Farm (SRWF)
- Offshore Converter Station (OCS-DC)
- SRWEC Landfall Location
- Sunrise Wind Export Cable (SRWEC-OCS)
- Sunrise Wind Export Cable (SRWEC-NYS)
- 10-mile Project Buffer
- 3-nm State Waters Boundary
- Artificial Reef
- Aids To Navigation
- Ferry Route
- High Frequency Radar Location
- ★ Unexploded Ordnance Location
- Submarine Cable
- Anchorage Area
- Unexploded Ordnance Area
- Ocean Disposal Area
- Pilot Boarding Area
- Cable and Pipeline Area
- Sand Borrow Area
- BOEM Lease Area
- BOEM Call Area
- BOEM Proposed Wind Energy Area
- Special Use Airspace Warning Area

Sources

1. BOEM, NOAA Office of Ocean Survey, U.S. Navy
2. Base map: USGS The National Map

Date	12/18/2020 Revised: 6/1/2021
Project Number	2028113199
Prepared By	GC
Reviewed By	LJ

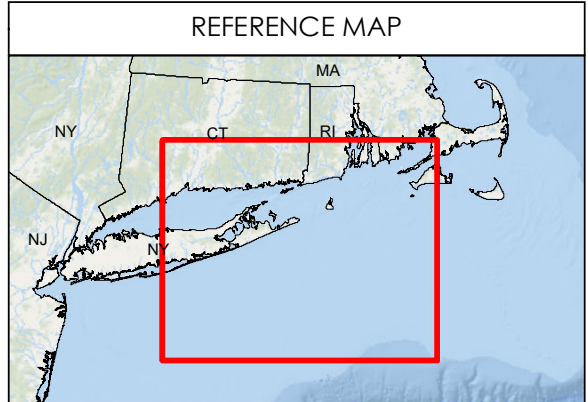
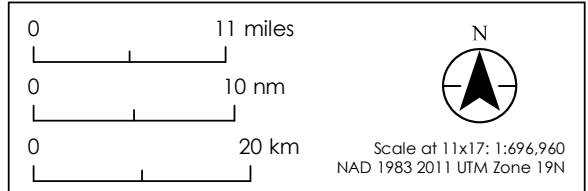

This page intentionally left blank

CONSTRUCTION AND OPERATIONS PLAN

Site Characterization and Assessment of Impacts – Socioeconomic Resources

Aids to Navigation

ATONs are structures intended to assist a navigator in determining position or safe course or to warn of dangers or obstructions to navigation. This data set includes lights, signals, buoys, day beacons, and other ATONs.

Alternative Energy Facilities

Alternative energy facilities are projects or lease areas that support, or are expected to support, the production and transmission of alternative energy. The Block Island Wind Farm, a 30-MW offshore wind farm located approximately 3 mi (5 km) southeast of Block Island, is the only active offshore alternative energy facility in the region. Multiple lease areas are under development for offshore wind energy projects within both the RI-MA WEA and the MA WEA, including South Fork Wind, Revolution Wind, Bay State Wind, Vineyard Wind, Park City Wind, and Mayflower Wind.

BOEM is also moving forward with wind energy planning efforts in the New York Bight region, which represents an area of shallow waters between Long Island and the New Jersey coast. It is estimated up to 9.6 GW of offshore wind energy could be generated on Lease tracts within the New York Bight (BOEM 2018). In December 2019, BOEM began to advance the development of primary and secondary draft Wind Energy Areas (WEAs), and in March 2021 identified final WEAs, although final Lease Areas may still be revised. Studies will collect and make public seabed soil and geological data for progressing the preliminary design and installation requirements for future offshore wind projects within the WEAs (NYSERDA 2019).

Anchorage Areas

An anchorage area is a location at sea where vessels may lower their anchors and moor the vessel. The locations usually have conditions for safe anchorage, providing protection from poor weather conditions and other hazards. They can also be used as a mooring area for vessels waiting to enter a port or as a short-term staging area.

Artificial Reefs

Artificial reefs within the region are generally created from obsolete materials, such as small steel boats and other marine vessels, surplus armored vehicles, tires, and concrete pipes, and are used to provide critical habitat for numerous species of fish in areas devoid of hard bottom (BOEM 2013). For example, the Massachusetts Division of Marine Fisheries repurposed culvert and bridge granite slabs from a commuter rail expansion project to create reef habitat in open water areas off Cape Cod (MADMF 2013).

Passenger Ferry Routes

Passenger ferries are commercial vessels used to carry passengers and their property from one shoreline to another. Such services in the region connect a variety of mainland (e.g., Newport, Point Judith) and island (e.g., Block Island and Martha's Vineyard) destinations within and adjacent to this area.

CONSTRUCTION AND OPERATIONS PLAN

Site Characterization and Assessment of Impacts – Socioeconomic Resources

High-Frequency Radar Locations

Preliminary modeling results and studies from Europe incorporating typical offshore wind farm configurations have indicated that wind turbines may impact HF radar systems. HF radar systems primarily measure ocean surface currents (speed and direction, determined from sea state). They are not used for navigation or aviation safety, or national defense. There are no industry-wide standard mitigation measures to address potential HF radar interference (BOEM Study 2019). Civilian-operated, NOAA-funded HF radar stations are within the region. These HF radar stations are shown on Figure 4.7.5-1 and include:

- HF radar on Block Island (two radars operated by University of Rhode Island and Rutgers University)
- HF radar on Martha's Vineyard (one radar operated by Rutgers University and three radars operated by Woods Hole Oceanic Institute)
- HF radar on Nantucket Island (one radar operated by Rutgers University and one radar operated by Woods Oceanic Institute)
- HF radar on Long Island (one radar operated by University of Rhode Island and two radars operated by Rutgers University)

Ocean Disposal Sites

There are several ocean disposal sites in the region, which the EPA designates and manages under the *Marine Protection, Research, and Sanctuaries Act (MPRSA)*. Most of these designated sites are for the disposal of dredged materials, and EPA is responsible for developing criteria to ensure that the ocean disposal of dredge spoils does not cause environmental harm. Water Quality Compliance determinations were made using the STFATE (ADDAMS) model, which incorporated parameters such as site description (distances and water depth), ambient velocity data (ft/sec), and disposal operation data.

Sand Borrow Areas

To address eroded beaches along five reaches of the south shore of Long Island between Fire Island Inlet and Montauk Point, a distance of approximately 83 mi (72 nm, 133 km), USACE monitors shoreline conditions and designates beach nourishment projects to distribute sand materials sourced from sand borrow areas located just offshore of the nourishment site. Sand borrow areas are within a 1-mi (1.6-km) radius from Project cables; however, cables do not directly intersect sand borrow areas. Measures to minimize the adverse impacts to any potential onshore transport processes include utilizing identified sand borrow areas for initial nourishment, providing pre- and post-dredging monitoring data collection, and allowing for adaptive management measures (USACE 2014).

Non-Energy Mineral Exploration

No existing or proposed offshore oil and gas platforms or marine aggregate mining has been identified in the region.

CONSTRUCTION AND OPERATIONS PLAN

Site Characterization and Assessment of Impacts – Socioeconomic Resources

Military Uses

Military uses (US Navy and other services, including Homeland Security [USCG]) span the SRWF, SRWEC–OCS, and SRWEC–NYS. Such uses exist largely because of the proximity to Naval Station Newport, Newport Naval Undersea Warfare Center (Rhode Island), Naval Submarine Base New London, and USCG Academy (City of New London) (BOEM 2013; RI CRMC 2010). The US Atlantic Fleet conducts training and testing exercises in the Narraganset Bay Operating Area, and the Newport Naval Undersea Warfare Center routinely performs testing in the area (BOEM 2012). Air National Guard training ranges are also located in this area. Currently there are no military uses on Long Island.

Offshore Scientific Assessments

Government-managed fisheries surveys, both state and federal, occur within the region at varying times of year. As an example, recent surveys were conducted by the Rhode Island Department of Environmental Management (RIDEM), Massachusetts Division of Marine Fisheries (MADMF), and NYSDEC. Based on recent funding commitments, more surveys are expected to be conducted by the Massachusetts Clean Energy Center (MassCEC) and the DoE Offshore Research and Development Consortium.

A variety of other surveys and scientific assessments are also in-progress or planned throughout various areas of the RI-MA WEA and the MA WEA. For example, Woods Hole Oceanographic Institution (WHOI) is conducting ocean surveys with buoys and autonomous underwater vehicles to survey temperature and salinity levels, and the Cox Ledge Study (funded through BOEM) is using an autonomous underwater glider and an acoustic telemetry receiver to detect fish spawning sounds, baleen whales, and tagged fish. These surveys overlap the Project Area.

Pilot Boarding Areas

Pilot boarding areas are locations at sea where pilots who are familiar with local waters board incoming vessels to navigate their passage to a destination port. Pilotage is required by law for foreign vessels and US vessels under register in foreign trade. Pilot boarding areas are represented by an 0.6 mi- (0.5 nm-; 0.9 km-) radius around a coordinate point unless the coast pilot specifically designates a different radius or boarding area boundary. According to NOAA, the nearest pilot boarding area is approximately 30 mi (48.3 km) from the SRWF, located between Montauk, NY and Block Island, RI.

Submarine Cables and Cable Areas

There are existing submarine cables that run through regional waters and which are laid on, or buried within, the seafloor and are used to transmit communications or power. Most of these existing cables pass through Green Hill, RI and along the south shore of Long Island, NY as depicted in Table 3.3.3-6, and Figure 3.3.3-10. In addition, there are NOAA nautical chart cable and pipeline areas that denote where such infrastructure may be located. The existence of these areas does not necessarily mean that actual cables or pipeline are present (BOEM 2013).

CONSTRUCTION AND OPERATIONS PLAN

Site Characterization and Assessment of Impacts – Socioeconomic Resources

MEC/UXO Risk Mitigation

MEC/UXOs are explosive weapons (e.g., bombs, shells, grenades, mines, torpedoes) that did not explode when they were deployed and still pose a risk of detonation. The US Atlantic Fleet conducts training and testing exercises near Long Island and Block Island Sounds. In the past, the Navy established testing ranges for torpedo, depth charge, and mine testing in these waters.

The Project will implement a MEC/UXO RARMS designed to evaluate and reduce risk in accordance with the ALARP risk mitigation principle. The RARMS consists of a phased process beginning with a Desktop Study and Risk Assessment that identifies potential sources of MEC/UXO hazard based on charted MEC/UXO locations and historical activities, assesses the baseline (pre-mitigation risk that MEC/UXO pose to the Project, and recommends a strategy to mitigate that risk to ALARP. Appendix G2 presents this study and strategies.

Sunrise Wind Farm

There are no existing coastal uses or infrastructure within the area proposed for the SRWF. Identified marine uses, as described above, within the SRWF include two temporary private ATONs, potential military use, other scientific assessments, and multiple submarine cables. Table 4.7.2-1 lists other marine uses within the vicinity of the SRWF. These uses are depicted in Figure 4.7.5-1.

Sunrise Wind Export Cable–OCS

Table 4.7.5-1 lists other marine uses that intersect or are within the vicinity of the SRWEC–OCS. These uses are depicted in Figure 4.7.5-1. One ATON is located within 0.5 mi (0.8 km); Moriches Anglers Reef, classified as both an artificial reef and an ocean disposal site, is located approximately 1.2 mi (1.9 km) north, and the SRWEC–OCS intersects several submarine cables. Additionally, SRWEC–OCS intersects a portion of a proposed WEA identified by BOEM, specifically the New York Bight Fairways North area.

CONSTRUCTION AND OPERATIONS PLAN

Site Characterization and Assessment of Impacts – Socioeconomic Resources

Table 4.7.5-1 Other Marine Uses within the Vicinity of the Project

Marine Use Type	Specific Details	Closest Approx. Distance and Direction from SRWF	Closest Approx. Distance and Direction from SRWEC OCS	Closest Approx. Distance and Direction from SRWEC NYS
ATONs	Structures intended to assist a navigator to determine position or safe course, or to warn of dangers or obstructions to navigation. This dataset includes lights, signals, buoys, day beacons, and other aids to navigation.	within boundary (Caribbean Wind Lighted Research Buoy BW1, and USACE Block Island Lighted Research Buoy 154; both are temporary private aids, not part of the Federal ATON system)	0.3 mi northeast (NOAA Data Lighted Buoy NOAA 44017)	1.9 mi north (Narrows Bay Buoy 4)
Alternative Energy Facilities	Alternative energy facilities are projects or lease areas that support, or are expected to support, the production and transmission of alternative energy. Multiple Lease Areas are under development for offshore wind energy projects within both the RI-MA WEA and the MA WEA. BOEM is also moving forward with wind energy planning efforts in the New York Bight region, which represents an area of shallow waters between Long Island and the New Jersey coast.	13.4 mi northwest (Block Island Wind Farm)	22 mi north (Block Island Wind Farm)	100 mi east (Block Island Wind Farm)
	Additional wind energy planning efforts are ongoing for the Outer Continental Shelf (OCS) in the New York Bight region which represents an area of shallow waters between Long Island and the New Jersey coast. In late 2019, BOEM began to advance the development of potential Wind Energy Areas (WEAs), and in March 2021 identified proposed WEAs, although final Lease Areas may still be revised.	67 mi west	Intersects SRWEC-OCS	35 mi southeast
Anchorage Areas	An anchorage area is a place where boats and ships can safely drop anchor. These areas are created in navigable waterways when ships and vessels require them for safe and responsible navigation. A variety of designations refer to types of anchorage areas or restrictions, or even to alerts of potential dangers within an area. Every boater and captain should be aware of the various types of areas. These data are intended for coastal and ocean planning.	13.67 mi northeast (Anchorage G)	21.7 mi north (Riverhead Anchorage Ground)	20.0 mi northwest (Port Jefferson Anchorage Ground)

CONSTRUCTION AND OPERATIONS PLAN

Site Characterization and Assessment of Impacts – Socioeconomic Resources

Marine Use Type	Specific Details	Closest Approx. Distance and Direction from SRWF	Closest Approx. Distance and Direction from SRWEC OCS	Closest Approx. Distance and Direction from SRWEC NYS
Artificial Reefs	An artificial reef is a human-made underwater structure, typically built to promote marine life in areas with a generally featureless bottom. These reefs help control erosion, block ship passage, or improve surfing. Many reefs are built using objects intended for other purposes, including the sinking oil rigs, scuttling ships, or deploying rubble or construction debris. Other artificial reefs are purpose-built using materials such as PVC or concrete. Regardless of construction method or source material, artificial reefs generally provide hard surfaces where algae and invertebrates such as barnacles, corals, and oysters can attach. The accumulation of attached marine life in turn provides an intricate structure of food for fish assemblages. This data set is NOT a complete collection of artificial reefs on the seafloor, nor are the locations to be considered exact. The presence and location of the artificial reefs have been derived from multiple state websites. These data are intended for coastal and ocean planning.	12.2 mi north (Rhode Island Sound)	1.2 mi north (Moriches Anglers Reef)	0.9 mi north (Moriches Anglers Reef)
High-Frequency Radar Locations	HF radar systems primarily measure ocean surface currents (speed and direction, determined from sea state). They are not used for navigation or aviation safety, or national defense. Civilian-operated, NOAA-funded HF radar stations are within the region. These systems include HF radar on Block Island, Martha's Vineyard, Nantucket and Long Island.	15 mi north (Nantucket)	20 mi north (Long Island)	10 mi (Long Island)
Passenger Ferry Routes	This data set contains established commercial passenger and vehicle water ferry routes for Rhode Island ports and ferry docks.	16.7 mi northwest (Interstate Navigation - Newport to Block Island)	21.8 mi north (Interstate Navigation - Newport to Block Island)	49.9 mi northeast (Viking Ferry Lines - Montauk to Block Island)
Military Uses	This area contains areas designated for training and testing exercises.	Within boundary of W-105A	Within boundary of W-105A	10 mi from W-106A

CONSTRUCTION AND OPERATIONS PLAN

Site Characterization and Assessment of Impacts – Socioeconomic Resources

Marine Use Type	Specific Details	Closest Approx. Distance and Direction from SRWF	Closest Approx. Distance and Direction from SRWEC OCS	Closest Approx. Distance and Direction from SRWEC NYS
Ocean Disposal Areas	<p>In 1972, Congress enacted the <i>Marine Protection, Research, and Sanctuaries Act</i> (MPRSA, also known as the Ocean Dumping Act) to prohibit the dumping of material into the ocean that would unreasonably degrade or endanger human health or the marine environment. Virtually all material ocean dumped today is dredged material (sediments) removed from the bottom of waterbodies to maintain navigation channels and berthing areas. Other materials that are currently ocean disposed include fish wastes, human remains, and vessels. Ocean dumping cannot occur unless a permit is issued under the MPRSA. In the case of dredged material, the decision to issue a permit is made by the USACE, using EPA's environmental criteria and subject to EPA's concurrence. For all other materials, EPA is the permitting agency. EPA is also responsible for designating recommended ocean dumping sites for all types of materials.</p>	<p>12.3 mi northwest (RI Sound Disposal Site - Dredged Material Disposal)</p>	<p>1.2 mi northwest (Moriches Anglers Reef - Rock Dumping Ground)</p>	<p>0.9 mi north (Moriches Anglers Reef - Rock Dumping Ground)</p>
Sand Borrow Areas	<p>To address eroded beaches along Fire Island and much of the southern Long Island coast, USACE monitors shoreline conditions and designates beach nourishment projects to distribute sand materials sourced from sand borrow areas located just offshore of the nourishment site. Measures to minimize the adverse impacts to any potential onshore transport processes include utilizing identified sand borrow areas for initial nourishment, and providing pre- and post-dredging monitoring data collection, and allowing for adaptive management measures (USACE 2014).</p>	<p>40 mi west</p>	<p>Does not intersect. Within 1-mi radius of SWEC-OCS</p>	<p>Does not intersect. Within 3-mi of SWEC-NYS (Robert Moses State Park to Smith Point County Park)</p>

CONSTRUCTION AND OPERATIONS PLAN

Site Characterization and Assessment of Impacts – Socioeconomic Resources

Marine Use Type	Specific Details	Closest Approx. Distance and Direction from SRWF	Closest Approx. Distance and Direction from SRWEC OCS	Closest Approx. Distance and Direction from SRWEC NYS
Pilot Boarding Areas	Pilot boarding areas are locations at sea where pilots familiar with local waters board incoming vessels to navigate their passage to a destination port. Pilotage is compulsory for foreign vessels and U.S. vessels under register in foreign trade. Individual ports may have additional pilotage regulations (see the applicable United States Coast Pilot for additional information). This dataset is one of two related feature classes which should be used in tandem. The sister dataset, of point geometry, is titled Pilot Boarding Stations. It represents point locations depicted on NOAA nautical charts or described in United States Coastal Pilots where pilots rendezvous with ships. In contrast, Pilot Boarding Areas are more general vicinities depicted on NOAA nautical charts. Pilots can rendezvous with ships anywhere within a Pilot Boarding Area. This dataset does not contain information regarding the hazards and considerations necessary to approach each port.	18.7 mi northwest	25.1 mi northwest	75.7 mi northeast
Submarine Cables and Cable Areas	Submarine Cables: These data depict the occurrence of submarine cables in and around U.S. navigable waters. The geographic extent of these data is greater than the "NASCA Submarine Cables" data set. The purpose of these data products is to support coastal planning at the regional and national scale. These data are derived from 2020 NOAA Electronic Navigational Charts (ENCs) and 2018 NOAA Raster Navigational Charts (RNCs). Abandoned cables, or cables that have been removed may appear within this data set. Features defined as cables were compiled from the original sources, exclusive of those features noted as 'cable areas'.	intersects SRWF (2 submarine cables)	intersects SRWEC-OCS (7 submarine cables)	intersects SRWEC-NYS (1 submarine cable)
	Submarine Cable Areas: This data set identifies locations that contain one or more submarine cable and/or pipeline areas.	16.7 mi northwest (cable area)	4.7 mi north (cable area)	4.6 mi north (cable area)

CONSTRUCTION AND OPERATIONS PLAN

Site Characterization and Assessment of Impacts – Socioeconomic Resources

Marine Use Type	Specific Details	Closest Approx. Distance and Direction from SRWF	Closest Approx. Distance and Direction from SRWEC OCS	Closest Approx. Distance and Direction from SRWEC NYS
UXO	<p>Ocean disposal of munitions was an accepted international practice until 1970, when it was prohibited by the Department of Defense. In 1972 Congress also passed the <i>Marine Protection, Research, and Sanctuaries Act</i> banning ocean disposal of munitions and other pollutants. This data set represents known or possible former explosive dumping areas and MEC/UXOs. This is NOT a complete collection of MEC/UXOs on the seafloor, nor are the locations considered to be accurate. Two related data sets should be viewed in tandem: Unexploded Ordnance Locations displays known/possible individual or tightly grouped unexploded ordnances on the ocean floor and Formerly Used Defense Sites (FUDS) displays areas identified by the United States Army Corps of Engineers where unexploded ordnances may exist.</p>	2.8 mi south (Unexploded Bombs)	9.5 mi southeast (Unexploded Bombs)	33.1 mi southwest (Danger Explosives Jettisoned)

CONSTRUCTION AND OPERATIONS PLAN

Site Characterization and Assessment of Impacts – Socioeconomic Resources

Sunrise Wind Export Cable–NYS

Table 4.7.5-1 lists the other marine uses that intersect or within the vicinity of SRWEC–NYS. These uses are depicted in Figure 4.7.5-1. An artificial reef and ocean disposal site are located approximately 0.9 mi (1.4 km) north, and the closest sand borrow area is located approximately 2.5 mi (4.0 km) to the southwest of the SRWEC–NYS. Three approaches are being explored for the HDD path for the SRWEC to reach the Landfall Work Area due to the presence of an existing telecommunications cable in proximity to the landfall location. SRWEC–NYS is less than 1 mi (1.6 km) from a sand borrow pit on Fire Island approximately along Robert Moses State Park to Smith Point County Park (USACE 2020).

Onshore Facilities

The affected environment for coastal land use includes the areas within the Town of Brookhaven, NY where the Onshore Facilities are planned. Figure 4.7.5-2 depicts land uses in the vicinity of the Onshore Facilities.

The Landfall is located on Smith Point, Fire Island, NY within a parking lot at Smith Point County Park. Based on information from the Town of Brookhaven Division of Public Information (2020), land use within the area is characterized as "Recreational and Open Space." Zoning in the vicinity is characterized as Commercial Recreation (CR)—consistent with the multiple parks and campground sites located throughout Fire Island.

Land use along the Onshore Transmission Cable route is predominantly medium-density residential, with pockets of recreational areas and open space. Zoning along the route is a mix of residential districts (A1/A2/A5/A10)—including single-family homes and two-family dwellings.

The proposed location for the OnCS–DC at the Union Avenue Site is in an area predominantly characterized as utility but which also includes industrial and large-scale commercial businesses. Zoning in the vicinity of the Union Avenue Site is Industrial (L1), and the area is surrounded by a mix of Industrial (L1/L2), Commercial Recreation (CR), and Business (J8) including the Morris Business Center between the Union Avenue Site and Morris Avenue. North of the Union Avenue Site, across the LIE corridor, is a mix of Industrial (L1) and Commercial Residential (CR).

V:\1956\active_Task Owner and other Non-BC\1956_Jobs\2028113199_03_data\gis_cad\gis\MDs\COP\2028113199_4.7.5-2_LandUse.mxd Revised: 2021-08-20 By: garpenier

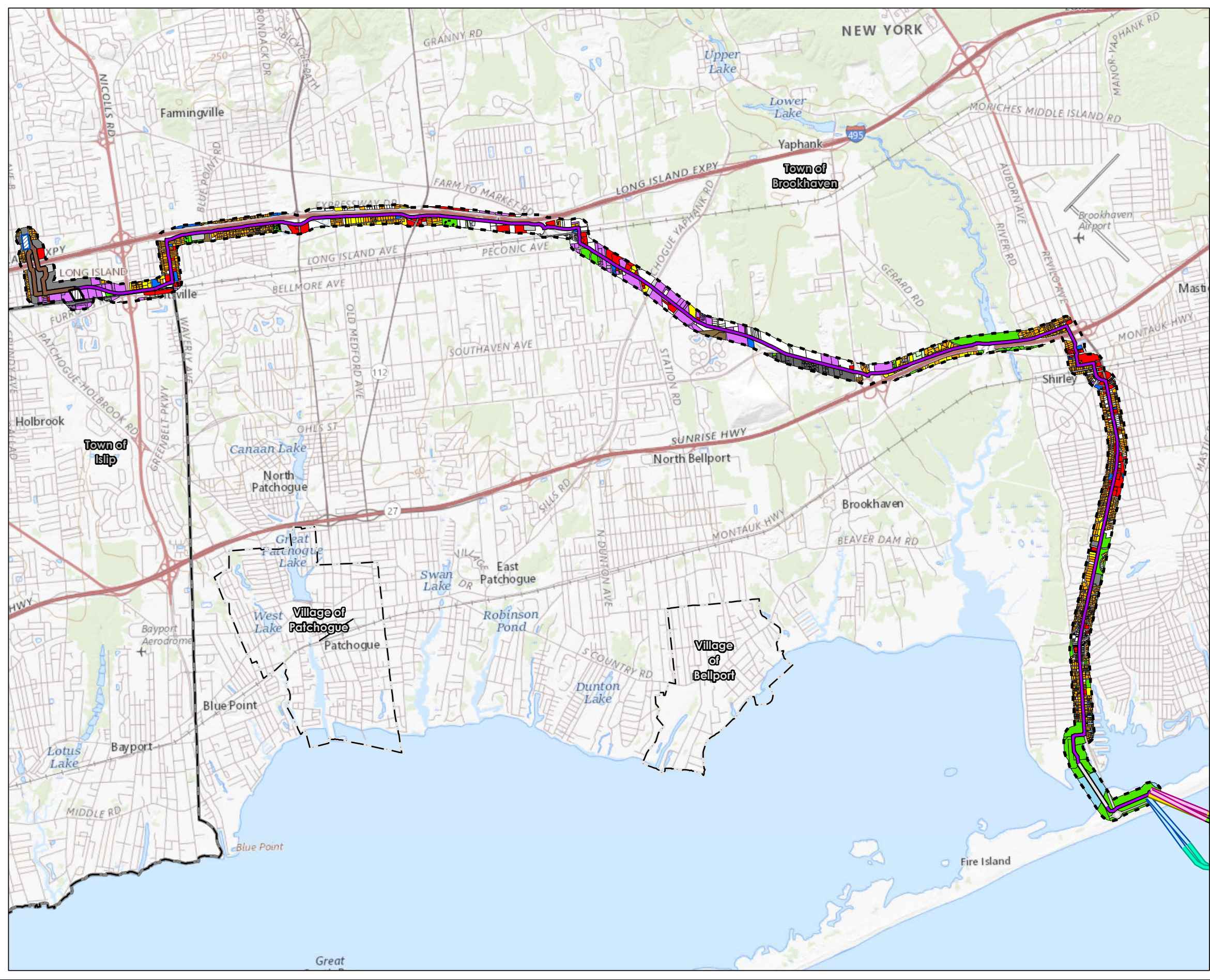

4.7.5-2 Existing Land Uses

Sunrise Wind | Powered by Ørsted & Eversource

Legend

- Sunrise Wind Export Cable (SRWEC-NYS)
- SRWEC-NYS (Western Landfall Option)
- Landfall HDD A
- Landfall HDD B
- Landfall HDD C
- Intracoastal Waterway HDD (ICW HDD)
- Onshore Transmission Cable-LIE Service Road Route
- 500 Feet from Project
- Union Avenue Site
- Onshore Interconnection Cable Route
- Holbrook Substation
- Village Boundary
- Town Boundary

Land Use

 Low Density Residential	 Agriculture
 Medium Density Residential	 Vacant
 High Density Residential	 Transportation
 Commercial	 Utilities
 Industrial	 Waste Handling & Management
 Institutional	 Surface Waters
 Recreation & Open Space	

Sources
Suffolk County Dept of Economic Development & Planning, 2016 NYS Office of IT Services GPO, NYS Boundaries, 2018 USGS Topo Map

Note
The cable route centerline and trenchless crossing work areas are indicative and subject to final engineering design.

Date	8/23/2021
Project Number	2028113199
Prepared By	PWB
Reviewed By	SBG

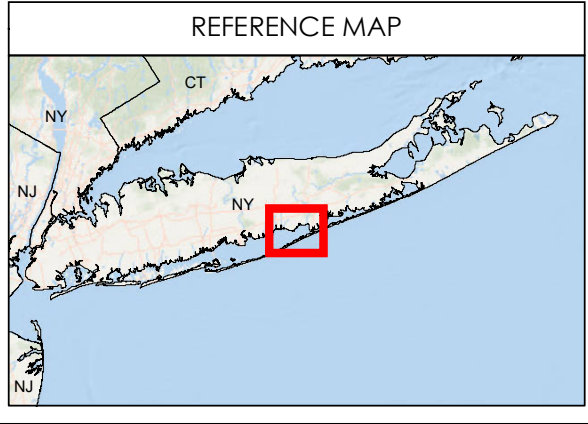
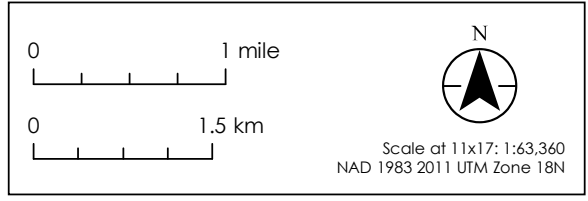

This page intentionally left blank

CONSTRUCTION AND OPERATIONS PLAN

Site Characterization and Assessment of Impacts – Socioeconomic Resources

4.7.5.2 Potential Impacts

The IPFs that could cause potential impacts to other marine uses and coastal land use during the construction and O&M of the SRWF, SRWEC, and Onshore Facilities are defined in Section 4.2 and illustrated on Figure 4.7.5-3. The potential for each IPF to result in measurable adverse impacts to coastal land and marine uses is evaluated below. Only seafloor disturbance associated with the construction and O&M of the SRWF and SRWEC would have the potential to affect offshore uses. The only potential impact associated with the construction and O&M of the Onshore Facilities would be land disturbance.

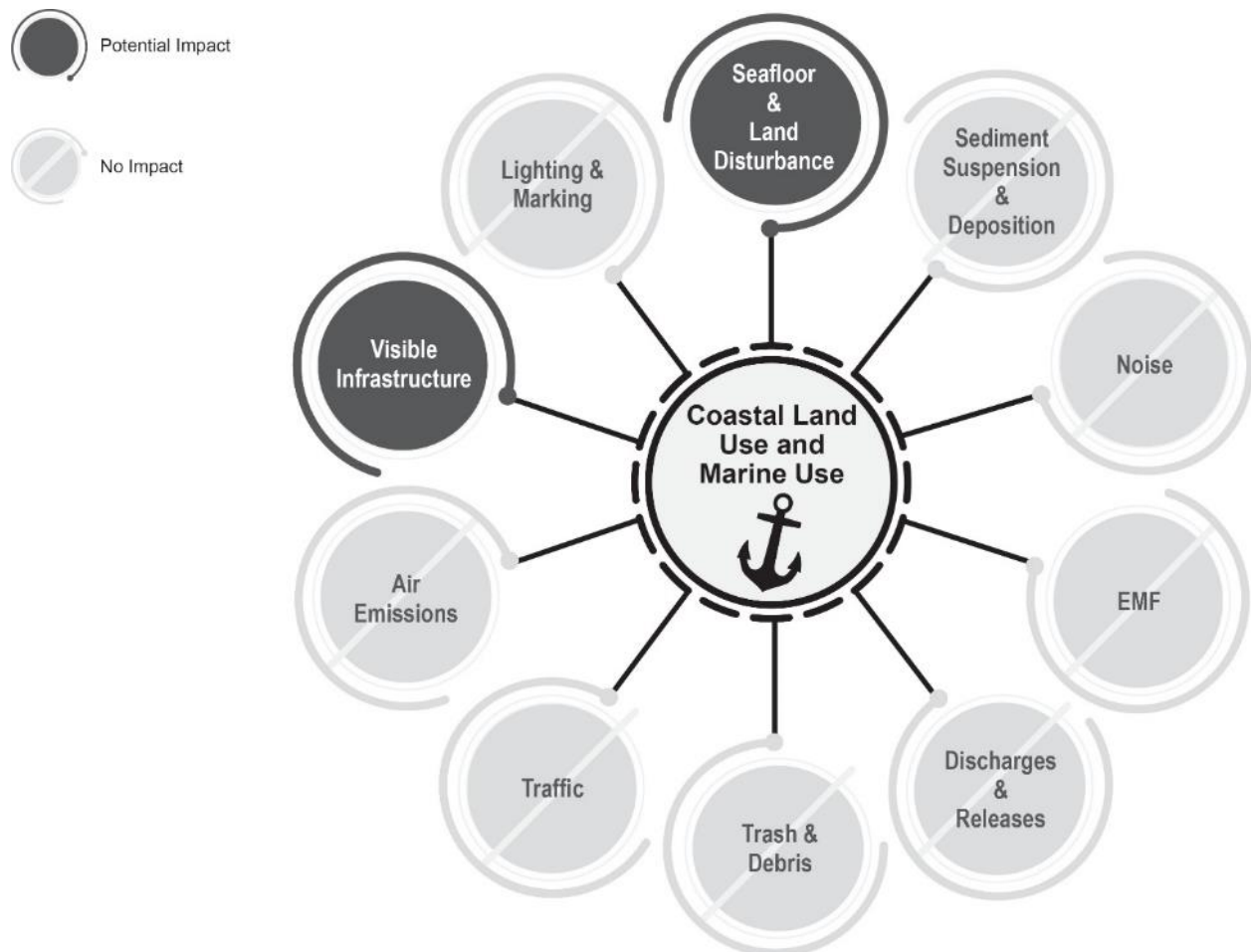

Figure 4.7.5-3 Impact-Producing Factors on Other Marine Uses and Coastal Land Use

Sunrise Wind Farm

During construction, there would be short-term, minor effects from seafloor disturbance to marine uses, but during operations, seafloor disturbance is not expected to affect existing marine uses. The construction and O&M of the SRWF is not expected to affect coastal land uses because activities will occur offshore within the SRWF.

CONSTRUCTION AND OPERATIONS PLAN

Site Characterization and Assessment of Impacts – Socioeconomic Resources

Construction

Seafloor Disturbance

Seafloor disturbance during construction has the potential to affect existing telecommunications cables located within the SRWF. Four potential WTG positions were removed from consideration due to their proximity to existing cables. The routes for the IAC were designed to minimize crossings, and, where practicable, existing cables will be crossed at a perpendicular angle (see Section 3.3.7 and Table 3.3.3-6). Sunrise Wind is also working with the asset owners to develop cable crossing and proximity agreements and cable protection measures.

Final crossing designs will be completed in coordination with each of the asset owners and formalized in crossing and proximity agreements, in line with International Cable Protection Committee recommendations. Crossing and proximity agreements will be provided in the FDR/FIR, to be reviewed by the CVA and submitted to BOEM prior to construction.

Prior to seafloor preparation, cable routing, and micrositing of all assets, the Project will implement a MEC/UXO RARMS designed to evaluate and reduce risk in accordance with the ALARP risk mitigation principle. The RARMS consists of a phased process beginning with a Desktop Study and Risk Assessment that identifies potential sources of MEC/UXO hazard based on charted MEC/UXO locations and historical activities, assesses the baseline (pre-mitigation) risk that MEC/UXO pose to the Project, and recommends a strategy to mitigate that risk to ALARP. Appendix G2 presents this study and strategies.

Avoidance is the preferred approach for MEC/UXO mitigation; however, it is anticipated that there may be instances where confirmed MEC/UXO avoidance is not possible due to layout restrictions, presence of archaeological resources, or other factors that preclude micro siting. In such situations, confirmed MEC/UXO may be removed through in-situ disposal or physical relocation. Selection of a removal method will depend on the location, size, and condition of the confirmed MEC/UXO, and will be made in consultation with a MEC/UXO specialist and in coordination with the appropriate agencies.

In-situ disposal will be done with low noise methods like deflagration of the MEC/UXO or cutting the MEC/UXO up to extract the explosive components. The MEC/UXO might also be relocated through a “Lift and Shift” operation, the relocation will be to another suitable location on the seabed within the APE or previous designated disposal areas for either wet storage or disposal through low noise methods as described for in situ disposal. For all MEC/UXO clearance methods, safety measures such as the use of guard vessels, enforcement of safety zones, and others will be identified in consultation with a MEC/UXO specialist and the appropriate agencies and implemented as appropriate.

During Project construction, the likelihood of MEC/UXO encounter is very low. Sunrise Wind will work with BOEM to identify appropriate response actions, which may include developing an emergency response plan, conducting MEC/UXO-specific safety briefings, retaining an on-call MEC/UXO consultant, or other measures (See Appendix G2 for additional detail).

While there may be short-term, limited restrictions on access during construction that could affect offshore scientific assessments, Sunrise Wind will address this issue through discussions among federal and state agencies.

CONSTRUCTION AND OPERATIONS PLAN

Site Characterization and Assessment of Impacts – Socioeconomic Resources

Operations and Maintenance

Seafloor Disturbance

Impacts to offshore scientific assessments may result from seafloor disturbance during O&M of the SRWF. Sunrise Wind will coordinate and communicate with researchers to determine the most effective approach for minimizing the impacts associated with the presence of these structures on the ability to successfully complete ongoing or planned scientific assessments.

Sunrise Wind will also coordinate with telecommunications cable owners to avoid potential impacts associated with O&M activity within proximity to their assets.

Research, surveys, or scientific assessments may be limited during O&M. Sunrise Wind is able to coordinate and communicate with stakeholders to minimize the potential effects during these assessments.

Visible Infrastructure

Impacts to offshore scientific assessments may result from the presence of physical structures (i.e., WTGs and OCS–DC) that may affect design and collection of scientific samples. Additionally, safety zones may be established around O&M activities on a case-by-case basis in coordination with the USCG. Similar to seafloor disturbance, Sunrise Wind will coordinate and communicate with stakeholders to minimize the potential effects to these assessments.

Preliminary modeling results and studies from Europe incorporating typical offshore wind farm configurations have also indicated that wind turbines may impact HF radar systems and long-range radar sites; however, there are no industry-wide standard mitigation measures to address HF radar interference (BOEM 2019). The presence of the WTGs for the duration of the O&M phase may interfere with the operation of HF radar stations (located on Block Island, Martha's Vineyard, and Nantucket Island) and three long-range radar sites (Falmouth ASR-8, Nantucket ASR-9 and Providence ASR-9). The SRWF will not interfere with weather radar in Cape Cod or Boston. Potential impacts to radar systems are described in Appendix Y1 – *Obstruction Evaluation and Airspace Analysis / Radar and Navigational Aid Screening Study*. Given that there are now operational offshore wind turbines at the BIWF, BOEM has completed a study through the Office of Renewable Energy Programs Environmental Studies Program that assessed the impact of offshore wind farms to the U.S. HF Radar Network (BOEM, 2018). The key findings of the BOEM study are that offshore wind turbines interfere with the operation of HF radars; interference can be simulated; and mitigation techniques range from insufficient to effective. The study determined that effective wind turbine interference mitigation techniques utilize wind turbine rotation rate estimates to remove Doppler spectrum signals. However, the study also indicated that further research and study are needed to advance the proposed mitigation approaches to operational status. Lessons learned from this program will be applied to the SRWF and Sunrise Wind is coordinating with DoD to address these potential radar impacts.

Sunrise Wind has also initiated coordination with the DoD Military Aviation and Installation Assurance Siting Clearinghouse and US Navy Seafloor Cable Protection Office to identify potential impacts to military operations conducted in the area, including impacts to Air National Guard operations and to NORAD homeland defense radar operations. Sunrise Wind is coordinating with DoD to address these potential impacts.

CONSTRUCTION AND OPERATIONS PLAN

Site Characterization and Assessment of Impacts – Socioeconomic Resources

Sunrise Wind Export Cable

During construction, there would be short-term, minor effects from seafloor disturbance to marine uses, but during operations, seafloor disturbance is not expected to affect existing marine uses.

Construction

Seafloor Disturbance

As described for the SRWF, construction of the SRWEC is not expected to affect the majority of other marine uses identified in the general vicinity.

The routes for the SRWEC were designed to minimize crossings, and, where practicable, existing cables will be crossed at a perpendicular angle (see Section 3.3.3.4 and Table 3.3.3-6). The Landfall HDD will be designed to avoid impacts to existing cable assets. Sunrise Wind is working with the existing cable owners and reviewing the geophysical survey data to determine the precise location of cables offshore and within the Landfall Work Area so that the Landfall HDD and SRWEC can be sited and designed to avoid impacts. Sunrise Wind is also working with the asset owners to develop cable crossing and proximity agreements and cable protection measures. Final crossing designs will be completed in coordination with each of the asset owners and formalized in crossing and proximity agreements, in line with International Cable Protection Committee (ICPC) recommendations. Crossing and proximity agreements will be provided in the FDR/FIR, to be reviewed by the CVA and submitted to BOEM prior to construction.

Although BOEM has indicated that the Fairways North WEA will not be included in a proposed 2021 lease sale (BOEM 2021), if it were to be included in a future lease sale, Sunrise Wind will have an easement for the SWREC and will coordinate with the future Lease owner on appropriate cable crossing, proximity, and protection measures, as appropriate.

The other closest marine uses within the vicinity are an ATON located approximately 0.5 mi (0.8 km) from the SRWEC and the Moriches Anglers Reef, classified as both an artificial reef and an ocean disposal site, which is located approximately 1.2 mi (1.9 km) north of the New York State territorial boundary. Construction is not expected to impact either of these marine uses.

Operations and Maintenance

Seafloor Disturbance

As described for the SRWF, Appendix G2 identified the likelihood of presence of MEC/UXOs, determined the levels of risk within the Study Area, and outlined mitigation recommendations for both human safety and environmental protection. The Project will implement measures identified in Appendix G2, as described in Section 3.3.3.4, to evaluate and reduce MEC/UXO risk in accordance with the ALARP risk mitigation principle.

No significant impacts to marine uses are anticipated during O&M of the SRWEC. Sunrise Wind will continue to coordinate with asset owners regarding O&M activities within proximity to existing cables.

CONSTRUCTION AND OPERATIONS PLAN

Site Characterization and Assessment of Impacts – Socioeconomic Resources

Onshore Facilities

Construction activities may result in limited short-term land use changes from land disturbance. Land disturbance may result in potential land use impacts. O&M is not anticipated to result in any land use impacts. O&M of the Onshore Transmission Cable and Onshore Interconnection Cable would not require rezoning of existing land uses as the cables would be located entirely underground within existing disturbed roadway, railroad and utility ROWs, and no ongoing land disturbance is expected following cable installation. Therefore, O&M of the Onshore Transmission Cable and Onshore Interconnection Cable would not impact present or future planned uses. O&M of the OnCS–DC would also be consistent with the existing land use and as such is not expected have any adverse land use impacts.

Construction

Land Disturbance

The Onshore Transmission Cable and Onshore Interconnection Cable would be constructed entirely underground and predominantly within existing ROW. Construction activity will result in visible site disturbance (e.g., tree clearing, earth moving, trenchless crossing installations, and cable installation), all of which could temporarily alter the visual character of the landscape. Following construction activities, temporarily disturbed areas within existing ROW will be stabilized and restored to their pre-existing condition. Therefore, land disturbance during construction of the Onshore Transmission Cable and Onshore Interconnection Cable is expected to result in short-term and limited effects on current land uses within, adjacent to, or proximate to these routes.

Visible Infrastructure

The OnCS–DC would be constructed on a parcel in the Town of Brookhaven's Industrial zoning district. Therefore, no significant impacts to land use would result from the presence of the OnCS–DC.

4.7.5.3 Proposed Environmental Protection Measures

Several environmental protection measures would help to minimize or avoid potential impacts to other marine uses and coastal land uses.

- Sunrise Wind will minimize conflicts with other marine uses, through development and implementation of a MEC/UXO risk assessment strategy, coordination with USCG and DoD (including Public Notices to Mariners), coordination with existing telecommunications cable owners, and coordination with BOEM and potential future lease owners if a lease area is identified at a future time in the area where the SRWEC is sited.
- Sunrise Wind will consult with the USCG, US Navy, Naval Undersea Warfare Center (NUWC), the Northeast Marine Pilots Association, and regional ferry service operators to avoid or reduce use conflicts.

CONSTRUCTION AND OPERATIONS PLAN

Site Characterization and Assessment of Impacts – Socioeconomic Resources

- Sunrise Wind has implemented, or will implement, a number of measures to minimize adverse effects on existing cables, such as dropping four WTG positions; minimizing the number of IAC and SRWEC crossings, and crossing perpendicular where feasible; designing the Landfall HDD to avoid existing cables; coordinating with telecommunications cable owners to develop cable protection design, crossing, and proximity agreements; and following International Cable Protection Committee (ICPC) recommendations during construction and O&M.
- Navigation lights, markings, sound signals, and other ATON, including AIS on select WTGs, will be installed and maintained as prescribed within the PATON permit issued by the USGC for each WTG and the OCS-DC.
- The locations of the SRWF, SRWEC, IAC, and associated cable protections will be provided to NOAA's Office of Coast Survey after installation is completed so that they may be marked on nautical charts.
- Onshore Facilities are primarily sited within previously disturbed and developed areas (e.g., roadways, ROWs, developed industrial/commercial areas) to the extent feasible, to minimize impacts to undisturbed coastal land uses.
- The construction of the Landfall and ICW HDD is expected to occur outside the summer tourist season, which is generally between Memorial Day and Labor Day. The construction schedule for the remaining Onshore Facilities will be designed to minimize impacts to the local communities to the extent feasible.
- Sunrise Wind will coordinate with local authorities and develop an MPT plan as part of the Project's EM&CP to minimize potential traffic impacts during construction.

4.7.6 Environmental Justice

This section describes the affected environment in the primary ROI and potential effects from the construction and operation of the Project as they relate to environmental justice. The description of the affected environment and assessment of potential impacts to environmental justice were developed by reviewing current public data sources related to environmental justice, including state and federal agency-published guidance documents and databases (e.g., Council on Environmental Quality, USCB), online data portals and mapping databases (e.g., Social Explorer), and the other technical analyses prepared for this COP. A description of the presence of environmental justice populations in the primary ROI, which includes the Project Area, is provided below followed by an evaluation of potential Project-related impacts. Although visual impacts cannot be completely avoided, many of these impacts would be temporary and none would result in disproportionately high and adverse human health or environmental effects on minority or low-income populations; therefore, communities in the expanded ROI are not included in this section (see Section 4.5.1).

CONSTRUCTION AND OPERATIONS PLAN

Site Characterization and Assessment of Impacts – Socioeconomic Resources

Executive Order (EO) 12898 requires that federal agencies take steps to identify and address disproportionately high and adverse health or environmental impacts of federal actions on minority and low-income populations (including populations who principally rely on fish or wildlife for subsistence). In response to EO 12898, the Council on Environmental Quality (CEQ) developed guidelines to assist federal agencies in identifying and addressing environmental justice concerns during the NEPA process. The guidelines include six principles, which should be utilized when conducting an environmental justice analysis (CEQ 1997).

1. Consider the composition of the affected area to determine if low-income, minority or tribal populations are present and whether there may be disproportionately high and adverse human health or environmental effects on these populations;
2. Consider relevant public health and industry data concerning the potential for multiple exposures or cumulative exposure to human health or environmental hazards in the affected population, as well as historical patterns of exposure to environmental hazards;
3. Recognize the interrelated cultural, social, occupational, historical, or economic factors that may amplify the natural and physical environmental effects of the proposed action;
4. Develop effective public participation strategies;
5. Assure meaningful community representation in the process, beginning at the earliest possible time; and
6. Seek tribal representation in the process.

According to the CEQ environmental justice guidance under NEPA, minorities are those groups that include American Indian or Alaskan Native; Asian or Pacific Islander; Black, not of Hispanic origin; or Hispanic. Minority populations are defined where either (a) the minority population of the impacted area exceeds 50 percent or (b) the minority population of the impacted area is meaningfully greater than the minority population percentage in the general population or other appropriate unit of geographic analysis (CEQ 1997). Low-income populations are identified using annual statistical poverty thresholds from the USCB (CEQ 1997).

States within the primary and expanded ROI have also developed guidance in addition to federal guidance on environmental justice. NYSDEC has developed its own guidance for incorporating environmental justice concerns into the permitting process in *Commissioner Policy 29, Environmental Justice and Permitting* (NYSDEC 2003). The policy is aimed at effective public participation and providing opportunities for communities and project sponsors to resolve issues of concern to affected potential environmental justice areas (i.e., minority or low-income communities). The guidance establishes thresholds for identifying minority and low-income communities (i.e., census block groups or contiguous area with multiple census block groups) at 51.1 percent in an urban area for minority communities and 23.59 percent for low-income communities (NYSDEC 2003). See Table 4.7.6-1 for information on environmental justice-related offices and policies for the states in the primary and expanded ROI.

CONSTRUCTION AND OPERATIONS PLAN

Site Characterization and Assessment of Impacts – Socioeconomic Resources

In consultation with BOEM, Sunrise Wind has engaged with representatives of American Indian (“Native American”) Tribes and communities in recognition of their unique cultural connections with the coastal lands and waters in the region. Occupation of the OCS prior to early Holocene sea-level rise would have been limited to ancestral indigenous communities and many northeastern tribes retain deep cultural connections to the now submerged lands upon which their ancestors once lived.

CONSTRUCTION AND OPERATIONS PLAN

Site Characterization and Assessment of Impacts – Socioeconomic Resources

Table 4.7.6-1 Environmental Justice Offices and Policies for States in the Primary and Expanded Region of Interest

State	Environmental Justice Office or Policy	Description/Purpose	Source
New York	NYSDEC Commissioner Policy 29, Environmental Justice and Permitting (2003)	Provides guidance for incorporating environmental justice concerns into the permitting process. The policy is aimed at effective public participation and providing opportunities for communities and project sponsors to resolve issues of concern to affected potential environmental justice areas (i.e., minority or low-income communities). The guidance establishes thresholds for identifying minority and low-income communities (i.e., census block groups or contiguous area with multiple census block groups) at 51.1 percent for minority communities in an urban area and 23.59 percent for low-income communities.	NYSDEC 2003
Connecticut	Connecticut Department of Energy & Environmental Protection (CT DEEP), Environmental Justice Program	To incorporate principles of environmental justice into aspects of the agency's program development, policy making, and regulatory activities, including developing strategies to increase public participation in the agency's decision-making process. Moreover, effective January 1, 2009, section 22a-20a of the Connecticut General Statutes (CGS) (formerly <i>Public Act 08-94</i>), along with the agency's existing Environmental Justice Policy, requires applicants seeking a permit for a new or expanded "applicable facility" that is proposed to be located in an "environmental justice community," to file an Environmental Justice Public Participation Plan with and receive approval from the agency prior to filing any application for such permit.	CT DEEP 2012
Maryland	Maryland Department of the Environment	Provides information and resources related to environmental justice (or the ability for all people to enjoy equally high levels of environmental protection)	Maryland Department of Environment 2020
Massachusetts	Massachusetts Department of Environmental Protection (MassDEP)	MassDEP's Environmental Justice Strategy and Public Involvement Plan is in development.	MassDEP 2020

CONSTRUCTION AND OPERATIONS PLAN

Site Characterization and Assessment of Impacts – Socioeconomic Resources

State	Environmental Justice Office or Policy	Description/Purpose	Source
Rhode Island	Rhode Island Department of Environmental Management, Policy for Considering Environmental Justice in the Review of Investigation and Remediation of Contaminated Properties (2009)	Provides for the proactive consideration of environmental justice relative to site investigations and property site remediation projects to enable all communities to have meaningful input in environmental decision-making regardless of race, income, national origin or English language proficiency (RIDEM 2009). As part of this policy, RIDEM is to map the locations of communities of concern, or Environmental Justice Focus Areas, which provide the basis for minimum notice requirements for the investigation and clean-up of contaminated sites; the policy notes that supplemental outreach may be necessary to provide for meaningful community participation	Rhode Island Department of Environmental Management 2009
New Jersey	New Jersey Department of Environmental Protection (DEP) Office of Environmental Justice	DEP's Office of Environmental Justice aims to empower residents and communities who are often outside of the decision-making process of government, address environmental concerns to improve the quality of life in New Jersey's overburdened communities, and guide state agencies and the DEP's program areas in incorporating environmental justice.	New Jersey DEP Office of Environmental Justice 2020
Virginia	Virginia Council on Environmental Justice (VCEJ)	Addressing environmental injustice has been and continues to be a focal point of Governor Northam's administration. Establishing a state advisory council on environmental justice was part of his campaign platform in 2017. Governor Northam issued EO-29 establishing the Virginia Council on Environmental Justice (VCEJ) on January 22, 2019. VCEJ aims to address consistency in how environmental justice issues are evaluated at the state level.	VCEJ 2020

CONSTRUCTION AND OPERATIONS PLAN

Site Characterization and Assessment of Impacts – Socioeconomic Resources

4.7.6.1 Affected Environment

This section presents the demographic analysis used to determine the presence or absence of minority and low-income populations in the communities within the primary ROI (Table 4.7.6-2). In this section, communities within the primary ROI are compared to their corresponding counties (or to New York City) for the purposes of the demographic analysis. This comparison includes information on the presence of minority or low-income populations within the primary ROI, which represents a broad study area inclusive of all Project components.

The following communities, as presented in Table 4.7.6-1, are potential environmental justice areas (i.e., have minority or low-income populations that meet or exceed the established thresholds): North Bellport, NY; City of Providence, RI; City of New London, CT; City of New Bedford, MA; Paulsboro, NJ; and the City of Norfolk, VA. This was determined based on them having a minority population either exceeding 50 percent or significantly higher than their corresponding county or other appropriate reference area (e.g., NYC), or a low-income population equal to or greater than 23.59 percent or significantly higher than their corresponding county.

Table 4.7.6-2 2018 Income and Minority Population Levels in the Primary Region of Interest

Entity	Population for whom Poverty is Determined /a	Percent of Population /c			
		With Income Below Poverty Level	Hispanic or Latino	Minority, not Hispanic or Latino	Total Minority /b
NEW YORK	19,108,993	15	19	27	46
<i>Suffolk County</i>	<i>1,459,856</i>	<i>7</i>	<i>19</i>	<i>14</i>	<i>33</i>
Town of East Hampton	21,838	9	20	6	26
Montauk	3,637	3	11	3	14
Town of Brookhaven	471,381	8	14	4	18
Port Jefferson Village	7,608	5	10	12	22
Brookhaven CDP	3,057	12	7	13	20
East Patchogue CDP	22,364	9	20	8	27
Fire Island CDP	233	13	31	4	35
Holbrook CDP	26,166	5	11	9	19
Holtsville CDP	19,316	5	13	12	25
Mastic Beach CDP	11,951	13	16	11	27
Medford CDP	23,855	9	22	11	32
North Bellport CDP	11,575	21	33	30	63
North Patchogue CDP	7,541	7	24	9	33
Shirley CDP	28,436	13	25	13	37
Yaphank CDP	5,576	4	15	13	28
<i>Albany County</i>	<i>291,649</i>	<i>12</i>	<i>6</i>	<i>25</i>	<i>31</i>
City of Albany	88,635	24	10	40	50
Town of Bethlehem	34,666	5	2	9	11

CONSTRUCTION AND OPERATIONS PLAN

Site Characterization and Assessment of Impacts – Socioeconomic Resources

Entity	Population for whom Poverty is Determined /a	Percent of Population /c			
		With Income Below Poverty Level	Hispanic or Latino	Minority, not Hispanic or Latino	Total Minority /b
Town of Coeymans	7,345	8	1	5	5
New York City	8,304,816	19	29	39	68
Brooklyn	2,576,152	21	19	45	64
Manhattan	1,585,578	17	26	27	53
CONNECTICUT	3,474,901	10	16	19	35
New London County	256,892	10	10	17	28
City of New London	23,272	29	35	27	61
MARYLAND	5,862,050	9	10	42	51
Baltimore County	806,907	9	5	39	44
Sparrows Point (Edgemere)	8,633	8	2	12	14
MASSACHUSETTS	6,593,960	11	12	18	30
Bristol County	543,583	12	8	13	21
New Bedford	93,393	21	20	21	41
NEW JERSEY	8,707,826	10	20	26	46
Gloucester County	286,910	7	6	17	23
Borough of Paulsboro	5,937	22	9	27	36
RHODE ISLAND	1,016,029	13	15	15	30
Providence County	609,204	16	22	19	41
City of Providence	165,721	26	43	26	69
Washington County	120,052	9	3	8	11
Town of Narragansett	15,526	17	4	3	7
Town of North Kingstown	25,886	9	3	9	11
VIRGINIA	8,162,107	11	9	32	41
Norfolk /d	220,136	20	8	52	60

SOURCE: USCB 2018a and 2018b

NOTES:

/a Poverty status was determined for all people except institutionalized people, people in military group quarters, people in college dormitories, and unrelated individuals under 15 years old.

/b Percentages may not add to totals due to rounding. Total minority includes Hispanic or Latino, Black or African American, Native American and Alaska Native, Asian, Native Hawaiian and Other Pacific Islander, and persons of some other race (not including White) or two or more races.

/c Bold percentages denote potential environmental justice areas.

/d Norfolk is a county equivalent area according to the USCB.

CONSTRUCTION AND OPERATIONS PLAN

Site Characterization and Assessment of Impacts – Socioeconomic Resources

Following is a discussion of the presence of minority and/or low-income populations within the primary ROI (only states with potential environmental justice areas are described below).

New York

- Four of the communities in New York are considered potential environmental justice areas: North Bellport, Brooklyn, Manhattan, and the City of Albany.
- North Bellport has a 63 percent minority population and a 21 percent low-income population, compared with 33 and 7 percent in Suffolk County, respectively. North Bellport is a hamlet and CDP in the Town of Brookhaven, along the north and south sides of Sunrise Highway between Southaven County Park on the east and Medford on the west. The Onshore Transmission cable would run underneath Horseblock Road—the northern boundary of North Bellport.
- Brooklyn has a minority population percentage of approximately 64 percent. Manhattan has a minority population of 53 percent.
- The City of Albany has minority and low-income percentages that are meaningfully greater than in Albany County (50 and 24 percent, respectively). In comparison, Albany County has a minority population percentage of 31 percent and a low-income population percentage of 12 percent.

Connecticut

- Sixty-one percent of the population of the City of New London is minority, which is significantly higher than the 28 and 35 percent minority populations of New London County and Connecticut, respectively.
- Twenty-nine percent of the population of the City of New London is living below the poverty level, which is significantly higher than in New London County (10 percent) and Connecticut as a whole (10 percent).

Massachusetts

- Forty-one percent of the population of New Bedford is minority, which is significantly higher than the 21 and 30 percent minority populations of Bristol County and Massachusetts, respectively.
- Twenty-one percent of the population of New Bedford has income below the poverty level, which is meaningfully greater than in Bristol County (12 percent) and Massachusetts as a whole (11 percent).

New Jersey

- Twenty-two percent of the population of Paulsboro has income below the poverty level, which is significantly higher than in Gloucester County (7 percent) and New Jersey as a whole (10 percent).
- Thirty-six percent of the population of Paulsboro is minority, which is significantly higher than in its corresponding county (23 percent), although lower than in the State of New Jersey overall (46 percent).

CONSTRUCTION AND OPERATIONS PLAN

Site Characterization and Assessment of Impacts – Socioeconomic Resources

Rhode Island

- Sixty-nine percent of the population of the City of Providence is minority, which is significantly higher than in Providence County (41 percent) and Rhode Island as a whole (30 percent); Providence County's minority population is also significantly higher than in the state.
- Twenty-six percent of the population of the City of Providence has income below the poverty level, which is meaningfully greater than the low-income population in Providence County (16 percent) and Rhode Island as a whole (13 percent).
- Additionally, RIDEM has mapped the entirety of the Quonset Business Park (Town of North Kingstown, RI) and some adjacent areas as an Environmental Justice Focus Area.

Virginia

- Sixty percent of the population of Norfolk is minority, which is significantly higher than Virginia's 41 percent minority population.

Twenty percent of Norfolk's population has income below the poverty level, which is meaningfully greater than the state of Virginia as a whole (11 percent).

4.7.6.2 Potential Impacts

Most of the activities associated with construction and O&M of the SRWF and SRWEC will occur in unpopulated areas in the open offshore waters of the Atlantic Ocean, many miles from the closest environmental justice community. Based on both archaeological analyses and traditional knowledge, indigenous use of the now-submerged SRWF and SRWEC may have occurred for thousands of years prior to early Holocene sea-level rise. Sunrise Wind has coordinated with representatives from several Native American tribes to identify potential environmental justice concerns related to the construction and O&M of the SRWF and SRWEC. Representatives from the Unkechaug Nation, Delaware Tribe of Indians, and Mashantucket Pequot Tribal Nation have expressed concerns that offshore construction activities may affect environmental and cultural resources of significance to their communities. In addition to concerns for potential Native American settlements and burials that may be preserved offshore, each of the tribes has an important and enduring maritime tradition that is significant to sustaining their communities and traditional cultural practices. Resources of concern to one or more of these communities that could be impacted by construction and O&M activities include quahog beds that provided both sustenance and raw materials for the production of traditional wampum. The Native American tribes with whom Sunrise Wind has coordinated also share a strong cultural connection with, and concern for, the North Atlantic right whale.

In addition to construction and O&M, the introduction of visible structures into an undeveloped section of the seascape may also impact visually sensitive resources associated with the traditional beliefs and practices of Native American communities within the ROI. For example, obstruction of lines-of-sight associated with ceremonies that are reliant on the observation of celestial/astronomical phenomena on the ocean horizon may impact such ceremonies and their practitioners.

CONSTRUCTION AND OPERATIONS PLAN

Site Characterization and Assessment of Impacts – Socioeconomic Resources

Detailed discussions of potential impacts to submerged archaeological resources, including those that may be associated with ancient Native American use of the OCS and nearshore areas are presented in Section 4.6.1. Potential impacts and environmental protection measures for shellfish and other culturally significant marine shellfish species of concern to the tribes are presented in Section 4.4.2. Impacts to visually sensitive resources, including culturally sensitive areas identified by tribal representatives or previously shared with BOEM are summarized in Section 4.5.1. Potential impacts and proposed environmental protection measures for the North Atlantic right whale, submerged aquatic vegetation and other culturally significant marine mammals are provided in Section 4.4.4.

Sunrise Wind will continue to engage with Native American tribes to identify feasible and appropriate measures to avoid, minimize, or mitigate impacts to culturally-significant marine species, submerged archaeological or other cultural sites, and visually sensitive locations associated with traditional cultural practices.

Moreover, the Project is anticipated to generate substantial economic benefits including job creation, as described in Section 4.7.1.

Environmental justice impacts from construction or O&M of the SRWF or SRWEC may occur and would be associated with Native American tribes with ancestral connections to the coastal lands, nearshore sections, and OCS that will be affected by construction of the SRWF and SRWEC. No other environmental justice impacts are anticipated from construction and O&M activities.

This conclusion is in keeping with the findings of the revised *Environmental Assessment for Commercial Wind Lease Issuance and Site Assessment Activities for the RI-MA WEA*, which noted that the WEA is 12 mi (19.3 km) or more from the nearest coastline, and thus offshore Project activities would not have disproportionately high and adverse environmental or health effects on minority or low-income populations (BOEM 2013).

Activities associated with construction and O&M of the Onshore Facilities would occur within the vicinity of one environmental justice community (i.e., North Bellport), located along approximately 2 mi (3.2 km) of Onshore Transmission Cable route. However, effects (e.g., traffic, noise) would be temporary, and no effects would be unique to minority or low-income populations.

In addition, the Project would meet or exceed compliance with applicable public information guidance and environmental justice regulations requiring effective public participation. For instance, CEQ guidance requires each federal agency to provide opportunities for effective community participation including identifying potential effects and mitigation measures in consultation with affected communities and improving the accessibility of public meetings, crucial documents, and notices.

Sunrise Wind is committed to robust, inclusive, and transparent public involvement, and will: 1) identify stakeholders in the area of the proposed Project; 2) advance public understanding of the Project; 3) encourage and collect public input; and 4) disseminate information to the general public and stakeholders that are directly affected by the Project. Sunrise Wind has identified a number of stakeholders and conducted extensive pre-application outreach over the months leading up to the Article VII filing in New York State. In addition to keeping agencies and elected officials apprised of Project developments, the Project team regularly engages with Native

CONSTRUCTION AND OPERATIONS PLAN

Site Characterization and Assessment of Impacts – Socioeconomic Resources

American tribes to provide updates, discuss survey protocols, and schedule and process for activities that may occur on or near tribal land. These regular discussions also include participation in calls hosted by BOEM that include members of the Project team and tribal representation. In response to data collected on language spoken in the Town of Brookhaven, which includes the entirety of the offshore route footprint, the Project team determined that Spanish-speaking translators will be available for any open houses. Additionally, Project collaterals for open houses and other public events will be available in English and Spanish. These collaterals include any printed materials, such as Project factsheets and issue-specific factsheets, that will be available for public takeaway. Members of the Project team are fluent in Spanish and will be utilized when needed.

To effectively communicate and engage with Sunrise Wind stakeholders and members of the public, the Project team has developed a series of tools and methodologies that will be implemented throughout the various phases of the Project. Sunrise Wind is also implementing strategies that can be deployed to address concerns related to COVID-19 and accompanying social distancing requirements. These strategies include a shifted focus toward virtual engagement through open house webinars and other online learning opportunities, an increased social media presence, and the reconsideration of practices such as door-to-door notifications.

4.7.6.3 Proposed Environmental Protection Measures

Several environmental protection measures will help to avoid potential impacts to environmental justice populations, as follows:

- The use of wind to generate electricity will have a beneficial impact on air emissions in Suffolk County, as it reduces the need for electricity generation from traditional fossil fuel power plants on Long Island that produce greenhouse gas emissions.
- Where feasible, local workers will be hired to meet labor needs for Project construction, O&M, and decommissioning.
- The construction of the Landfall and ICW HDD is expected to occur outside the summer tourist season, which is generally between Memorial Day and Labor Day. The construction schedule for the remaining Onshore Facilities will be designed to minimize impacts to the local communities to the extent feasible.
- Sunrise Wind will coordinate with local authorities and develop an MPT plan as part of the Project's EM&CP to minimize potential traffic impacts during construction.
- Onshore activities within potential Environmental Justice areas are limited to work within roadways/ROWs such that any potential adverse effects from construction/noise would be short-term and temporary.
- WTGs will be aligned and spaced consistently with other offshore wind facilities in the RI/MA WEA, reducing the potential for visual clutter.
- WTGs will be painted to minimize visual contrast under common and prevailing atmospheric conditions.

CONSTRUCTION AND OPERATIONS PLAN

Site Characterization and Assessment of Impacts – Transportation and Navigation

- Sunrise Wind is committed to avoiding impacts to submerged cultural resources wherever feasible and practicable and will continue to assess means of minimizing physical impacts to resources that cannot be avoided.
- Sunrise Wind will continue to engage with Native American communities to identify other measures that feasibly and appropriately protect culturally sensitive marine species and respectfully incorporate traditional knowledge and practices in such measures.

4.8 Transportation and Navigation

4.8.1 Marine Transportation and Navigation

This section describes the affected environment and potential effects from the construction and operation of the Project as they relate to marine transportation and navigation. The description of the affected environment and assessment of potential impacts were developed by reviewing current public data sources, including state and federal agency-published papers and databases; online data portals and mapping databases (e.g., the Northeast Ocean Data and Mid-Atlantic Ocean Data Portals); published scientific literature relating to the effects of wind turbines on radar and communications; and correspondence with federal and state agencies as well as maritime stakeholders. A description of marine transportation and navigation in the marine components of the Project Area is provided below, followed by an evaluation of potential Project-related impacts. More detailed information concerning marine transportation and navigation is presented in Appendix X and additional information concerning socioeconomic effects at ports can be found in Section 4.7.5.

4.8.1.1 Affected Environment

In support of the assessment of the Project's potential effects on marine transportation and navigation, an NSRA was conducted and is provided in Appendix X. Appendix X includes a detailed analysis of marine traffic, including, but not limited to, one year of data from vessels transmitting AIS data. AIS is an onboard VHF electronic information exchange system required on nearly all commercial vessels.²⁵ Appendix X assessed a broad range of factors related to navigation, including the risk of allision with fixed structures such as WTGs, and the Project's potential effects on radar and communications systems, Search and Rescue (SAR), and visual navigation. Appendix X was prepared in accordance with USCG guidance for Offshore Renewable Energy Installations (Navigation and Vessel Inspection Circular No. 01-19), pursuant to 30 CFR Part 585 Subpart F.

²⁵ Title 33, Code of Federal Regulations, Part 164, lists the vessel types required to carry an AIS, which include but are not limited to all self-propelled vessels of 65 ft or more in length engaged in commercial service.

CONSTRUCTION AND OPERATIONS PLAN

Site Characterization and Assessment of Impacts – Transportation and Navigation

Regional Overview

Existing marine traffic and navigation conditions in the region were analyzed in Appendix X (Figure 4.8.1-1). The Marine Traffic Study Area is inclusive of the SRWF and proximal areas (i.e., the Wind Farm Assessment Area on Figure 4.8.1-1), and extends north to the coast and south beyond the extent that the Project is expected to influence navigation safety risk (see Section 11, Appendix X). The Narragansett Bay, Buzzards Bay, Vineyard Sound, Block Island Sound, and the waters surrounding the SRWF and SRWEC serve as an important conduit for maritime commerce in the New England and North Atlantic region. As described in the following sections, these waters are transited by commercial vessels, military vessels, and recreational watercraft. Commercial and military traffic operates within these waters throughout the year, while recreational vessels are influenced by season and variations in the weather.

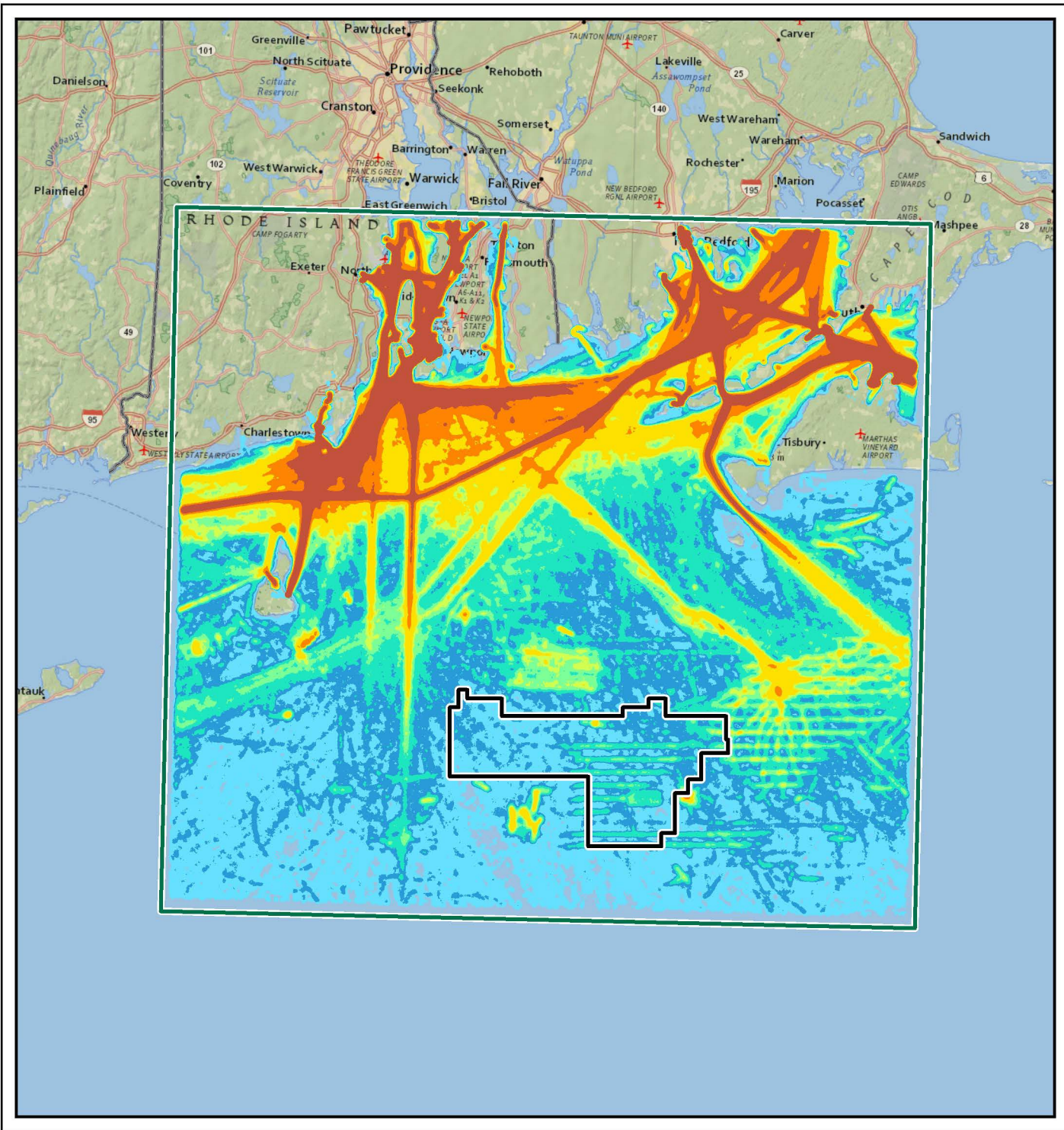

Figure 4.8.1-1
Existing Marine Traffic for the
Marine Traffic Study Area
Sunrise Wind | Powered by Ørsted & Eversource

Legend

Project Components

- Wind Farm Assessment Area
- Marine Traffic Study Area

Point Density* (All Vessels)

- 0 - 5
- 6 - 25
- 26 - 50
- 51 - 100
- 101 - 150
- 151 - 200
- 201 - 500
- 501 - 1,000
- > 1,000

Sources
 Marine Traffic, ArcGIS Online

Date	08/19/2020
Project Number	10203007
Prepared By	CHELSEA SCHEKKE
Reviewed By	IAN EVANS

0 5 Miles
 0 5 NM
 0 5 KM

Scale at 11x17: 1:800,000
 NAD 1983 2011 UTM Zone 19N

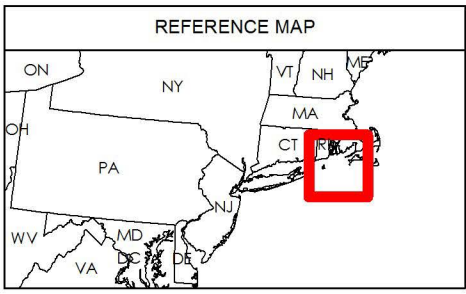

This page intentionally left blank

CONSTRUCTION AND OPERATIONS PLAN

Site Characterization and Assessment of Impacts – Transportation and Navigation

Sunrise Wind Farm

The relative proportions of vessel traffic in the Wind Farm Assessment Area are shown in Figure 4.8.1-2. Pleasure, fishing, and other/undefined vessels comprise the majority of the marine traffic.

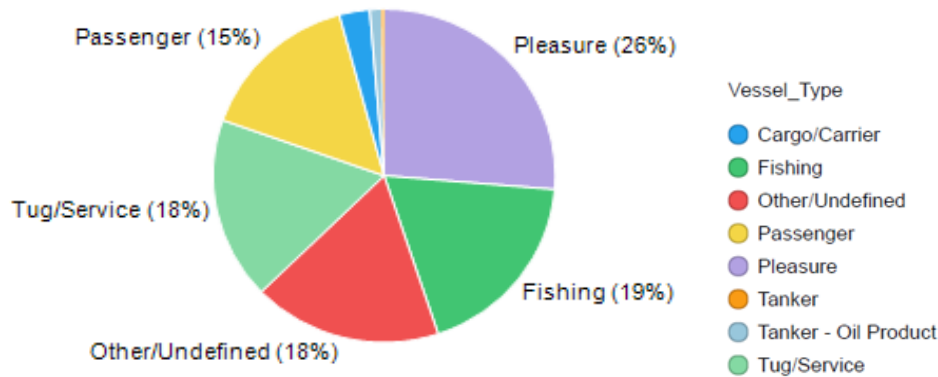

Figure 4.8.1-2 Distribution of vessel tracks in the Marine Traffic Study Area (July 1, 2018 to June 30, 2019)

Pleasure and recreational vessels are defined in Appendix X as AIS ship types “Pleasure Craft,” “Sailing Vessel,” and “Yacht.” The data show pleasure and recreation vessel traffic primarily occur near the coast, with relatively few tracks in the Wind Farm Assessment Area. The pleasure and recreational tracks that transit through the Wind Farm Assessment Area have either northwest-southeast or southwest-northeast general directionality. Relatively higher levels of traffic occur closer to the coastline. This coastal traffic consists primarily of fishing, pleasure, tug, and other vessel types.

Fishing vessel traffic is more dense near the coast and Martha’s Vineyard, and becomes less dense with increasing distance from land. Based on the most recently available VMS data from NOAA Fisheries, the primary types of fishing that occurred in the SRWF from 2011 through 2015 included gillnet and bottom trawl (Communities at Sea, MARCO 2020). To a lesser extent, fishing by dredge, pots, and traps also occurred in the Wind Farm Assessment Area. Fishing vessel traffic also transits through the SRWF to fishing grounds southeast of the SRWF. (See Section 4.7.4 for further discussion on commercial and recreational fishing activities.)

“Other” vessels include research vessels and military vessels. Most of these vessels transit near the coast and do not enter the Wind Farm Assessment Area. The majority of “other” vessel tracks within the Wind Farm Assessment Area and the lines of more dense traffic just east of it are from survey vessels related to the Project and Bay State Wind, as well as the South Fork Wind and Revolution Wind projects to the north, based on the linear patterns produced by their tracks. “Other” vessel tracks outside the SRWF are likely to also include fishing vessels in transit to common fishing areas (USCG 2020).

The AIS tracks for tugs and service vessels show a distinct coastwise pattern. The tugs and service vessels transiting to/from open waters generally transit the Buzzards Bay Traffic Separation Scheme. Very few tug tracks cross the Wind Farm Assessment Area.

CONSTRUCTION AND OPERATIONS PLAN

Site Characterization and Assessment of Impacts – Transportation and Navigation

Passenger vessels (including ferries, cruise ships, and local sightseeing vessels) primarily follow established routes near the coast and within the Narragansett Bay Traffic Separation Scheme. Very few passenger vessel tracks cross the Wind Farm Assessment Area.

Cargo, carrier, and tanker vessels transport goods such as petroleum products, coal, commodities, and food to/from ports in the area. They transit the main shipping routes in the designated Traffic Separation Schemes. The AIS data show fewer than one cargo vessel and one tanker per day transited the Wind Farm Assessment Area. These vessels predominantly transit two main courses through the larger NSRA Study Area:

- South-north and vice-versa via the Narragansett Bay Traffic lanes or just west of them. The route transits to the west of the Wind Farm Assessment Area.
- East-west and vice-versa between Buzzards Bay and Block Island Sound. The route transits to the north and northwest of the Wind Farm Assessment Area.

The SRWF is located southeast of the entrance to Narragansett Bay and due south of the entrance to Buzzards Bay. Two traffic separation schemes have been implemented in the area to separate traffic traveling in opposite directions: the Narragansett Bay Traffic Separation Scheme (TSS; traffic transiting north-south) and the Buzzards Bay Traffic Separation Scheme (traffic transiting southwest-northeast). The Narragansett Bay and Buzzards Bay TSSs are joined by a 5.4 nm (10 km) radius Precautionary Area located to the east of Block Island. The Buzzards Bay TSS is 5.7 nm (10.6 km) from the SRWF, and the Narragansett Bay TSS is 10 nm (18.5 km) from the SRWF. South of the SRWF is the Nantucket to Ambrose Fairway, connecting the Nantucket to Ambrose TSS south of Long Island, New York, to the Nantucket to Boston Harbor TSS southeast of Nantucket. A Fairway or Shipping Safety Fairway is an official lane or corridor in which no fixed structures can be installed. For the purposes of this analysis, the Nantucket to Ambrose Fairway will be described heretofore as “the Fairway.”

In general, the level of marine traffic in the Wind Farm Assessment Area is comparatively lower than traffic in surrounding areas.

The distribution of vessel types that transit in the NSRA Marine Traffic Study Area was analyzed using cross-sections of major marine routes. Most of the cross-sections have traffic levels of less than 10 transits per day (less than 3,650 transits per year). Two cross-sections (i.e., at the entrance of Narragansett Bay via East Passage and Point Judith) each have higher annual transit counts, with close to 36 transits per day (13,000 transits per year). These are more than 20 nm (37 km) from the SRWF.

Appendix X includes a summary of vessel sizes per vessel type. Tankers (with hydrocarbon cargo) are the largest vessels in the area. Based on the speed profile from AIS data, most vessel transits had calculated speeds between 5 and 15 knots.

The layout of the Project's offshore structures is one of the factors that will be considered by the USCG when planning SAR activities in the SRWF. The Massachusetts and Rhode Island Port Access Route Study report provides a summary of SAR incident data from 2005 through 2018. The report states (USCG 2020),

CONSTRUCTION AND OPERATIONS PLAN

Site Characterization and Assessment of Impacts – Transportation and Navigation

“Multiple orientations of 1 nm [1.15 mi, 1.85 km] spacing between structures would provide more flexible options for search patterns, especially where USCG assets are constricted by weather and wind. In some cases, weather and wind may be so severe as to not allow for USCG assets to enter the WEA.”

WTGs and the OCS–DC will be sited in a uniform east-west/north-south grid with 1.15 by 1.15-mi (1 by 1-nm; 1.85 by 1.85-km) spacing conforming to the USCG recommendation for minimum spacing between structures along a search path (USCG 2020) and visual flight rules in 14 CFR 91.155 specifying a minimum of 0.5-mi (0.43-nm, 0.8-km) visibility in daytime without clouds.

Table 4.8.1-1 lists key information requested in NVIC 01-19 to be considered by the USCG when evaluating emergency response. Approximately 20 SAR cases were recorded in the SRWF over the reported 14-year period, an average of 1.4 per year (Table 4.8.1-1). About 25 percent of these are reasonably expected to occur at night or in poor visibility. Offshore structures may be beneficial to SAR due to their identifiable markings, and the OCS–DC may provide opportunities for helicopters to land during SAR if a helideck is installed.

Table 4.8.1-1 Summary of Search And Rescue Cases in the Sunrise Wind Farm

Situation	Number of Occurrences
SAR cases conducted by USCG in or proximal to the SRWF	Approximately 20 cases over 14 years, 2005 through 2018 (USCG 2020)
Cases at night or in poor visibility/low ceiling	Unknown; however, based on data provided for the South Fork Wind Farm area, less than 25 percent of the cases were conducted at night and/or with poor visibility (USCG 2017)

Onshore Facilities

The Onshore Transmission Cable will be installed via HDD below the Long Island ICW. This area of the ICW is used primarily for recreational traffic and includes a navigation channel maintained by the USACE, the Long Island ICW, and has an existing drawbridge (William Floyd Parkway, Smith Point Bridge).

The remainder of the Onshore Transmission Cable will be installed within existing roadways and is not expected to affect marine transportation or navigation.

4.8.1.2 Potential Impacts

Specific aspects of Project construction, O&M, and decommissioning have the potential to impact marine transportation and navigation.

CONSTRUCTION AND OPERATIONS PLAN

Site Characterization and Assessment of Impacts – Transportation and Navigation

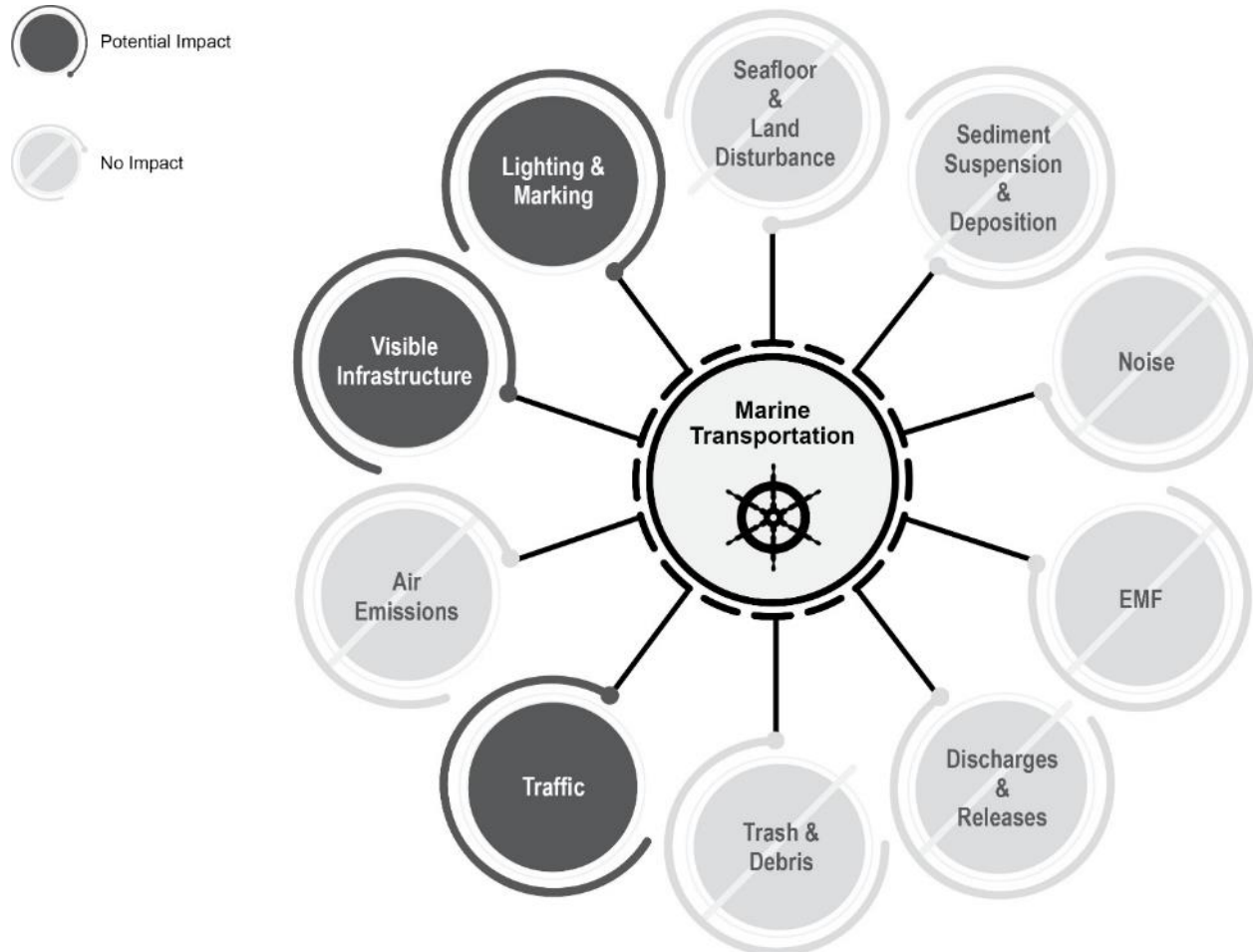

Figure 4.8.1-3 Impact-Producing Factors on Marine Transportation and Navigation

Construction of the SRWEC will require activity within a specified corridor, including seafloor preparation, temporary anchoring, and installing the subsea cable. This activity will require fewer vessels than those required for the SRWF, which will be present for shorter durations. Construction of the SRWEC will result in a temporary increase in vessel traffic; however, it is not expected to have measurable impacts on existing marine transportation and navigation. Impacts during O&M also are not expected to be measurable. Therefore, potential impacts from construction and O&M of the SRWEC were not evaluated herein.

Construction of the Onshore Facilities will involve the use of HDD under the ICW (as described in Section 3.3.3.3). No construction vessels will be present within the ICW, thereby avoiding any potential navigational hazards to small vessel operators. Impacts during O&M also are not expected to be measurable. Therefore, potential impacts from construction or operation of Onshore Facilities were not evaluated herein. For the decommissioning phase of the Project, impacts are anticipated to be similar to or less adverse than those described for construction; therefore, impacts from decommissioning are not addressed separately in this section.

CONSTRUCTION AND OPERATIONS PLAN

Site Characterization and Assessment of Impacts – Transportation and Navigation

Sunrise Wind Farm

Based on the IPFs illustrated in Figure 4.8.1-3, during construction of the SRWF, temporary impacts from increased traffic and lighting/markings will occur to existing marine transportation and navigation. Similarly, during O&M of the SRWF, temporary impacts from increased traffic and long-term impacts from visible infrastructure and lighting/markings will occur to existing marine transportation and navigation.

Construction

IPFs resulting in potential impacts on marine transportation and navigation from construction of the SRWF are illustrated in Figure 4.8.1-3 and discussed below.

Traffic

Construction activities will result in an increase in vessel movements that have the potential to overlap with existing marine transportation. Construction of the SRWF is anticipated to take place within specified work windows for activities. Offshore installation is anticipated to begin in Q2 2024 and end in Q4 of 2025, as detailed in Section 3.2.1. Vessels anticipated to be present during construction include construction barges, support tugs, jack-up rigs, supply/crew vessels, and cable laying vessels. Details on the type and number of vessels expected to operate for the construction of the SRWF are included in Table 3.3.10-3. However, not all vessels presented in Table 3.3.10-3 (69 total) are expected to be operating at one given time, and the increase in construction vessel traffic will be temporary.

For each vessel type, a route plan for the vessel operation area will be developed to meet industry guidelines and best practices in accordance with International Chamber of Shipping guidance. The Project will install operational AIS on all vessels associated with construction to monitor the number of vessels and traffic patterns for analysis and compliance with vessel speed requirements. All vessels will operate in accordance with applicable rules and regulations for maritime operation within US and federal waters. Additionally, the Project will adhere to vessel speed restrictions as appropriate in accordance with BOEM and NOAA requirements.

Construction activities could affect navigation of smaller vessels if smaller vessels operate close to construction work vessels during construction operations. However, this risk would be mitigated by a safety zone anticipated to be implemented by the USCG during construction operations, as further discussed below in the environmental protection measures section. The Project has committed to informing mariners about offshore activities related to the Sunrise Wind Farm. Fisheries liaisons and a team of fisheries representatives are based in regional ports, and updates will be provided to mariners online and via twice-daily updates on Very High Frequency (VHF) channels. Mariner Radio-Activated Sound Signals (MRASS) are also VHF-based and are expected to be deployed for the Project, similar to the deployment at Block Island Wind Farm. To reduce the likelihood of an allision or collision during construction, Project safety vessel(s) will be on scene to advise mariners of construction activity. In addition, Sunrise Wind will implement a communication plan during construction to inform mariners of construction activities, vessel movements, and how construction activities may affect the area. Communication will be facilitated through maintaining a Project website, the Fisheries Liaisons, submitting local notices to mariners and vessel float plans, in coordination with the USCG.

CONSTRUCTION AND OPERATIONS PLAN

Site Characterization and Assessment of Impacts – Transportation and Navigation

With these measures implemented, the SRWF is expected to have a minimal and temporary impact on marine traffic during construction.

Visible Infrastructure

The physical presence of installation vessels and SRWF components may impact passing mariners because there will be a minimum safety perimeter around installation vessels and locations where the SRWF components will be installed. This temporary restricted area will consist of a maximum 500-yard (457-m) safety zone and, therefore, access to boating within this zone may be restricted. However, these measures will be temporary and are expected to have minimal impact on marine traffic during construction as mariners can opt to navigate around the temporary safety zones. Although the gradual development of the WTG structures will occur on the landscape during the construction phase, impacts from visible infrastructure associated with the fully installed WTG structures are assessed under O&M below.

Lighting and Marking

The appropriate lighting and marking of the OCS–DC and WTGs will be installed and activated as the structures are gradually put into place; therefore, lighting within the SRWF will increase as construction of the SRWF progresses. For additional information on lighting of installed and operational structures, refer below to the O&M Lighting and Marking section and Section 3.5.7.

Operations and Maintenance

IPFs resulting in potential impacts on marine transportation and navigation from O&M of the SRWF are illustrated in Figure 4.8.1-3 and discussed below.

Traffic

As detailed in Appendix X, marine non-Project traffic may be generated by the presence of the operating SRWF. This increase in traffic may occur because of increased public interest, which could increase recreational boating interest around the WTGs. A conservative upper estimate for the first operational year of the Project was determined in Appendix X to be 100 additional trips per year within the SRWF.

Marine transportation types such as fishing, shallow draft passenger, and pleasure vessels are likely to continue to navigate through the SRWF. Modification of marine traffic routes for some ship types may occur due to the presence of the WTGs. Vessels such as deep draft and commercial vessels (excluding commercial fishing vessels), may navigate around the WTGs instead of through them. However, the extent to which they may adjust their course is unknown.

During operation of the SRWF, vessels will be free to navigate within, or close to, the Project. The risk of collision will be mitigated by the amount of space between the WTGs. Spacing between WTGs is anticipated to be a minimum of 1.15 mi (1 nm, 1.85 km). This design is a navigation measure itself and provides enough room for most vessels to transit through and safely maneuver within the SRWF. This risk is also mitigated by vessels complying with general rules and regulations and by vessels following the COLREGs during both active working activities and transit activities. COLREGS Rule 5 states “at all times maintain a proper lookout by sight and hearing as well as by all available means appropriate in the prevailing circumstances and conditions so as to make a full appraisal of the situation and risk of collision.”

CONSTRUCTION AND OPERATIONS PLAN

Site Characterization and Assessment of Impacts – Transportation and Navigation

Assessment of collision, allision, and grounding (i.e., a marine accident) was conducted for current traffic conditions at SRWF ("Base Case") and for traffic conditions after operation of the SRWF ("Future Case"). Modeling showed that the frequency of marine accidents increases by 1.6 accidents per year, with marine accidents involving fishing vessels representing 94 percent of this increase. The frequency increase includes all potential accidents including small and zero consequence accidents such as bumping into a foundation while drifting.

The relatively small, expected increase in marine traffic is expected to have minimal impact on existing marine transportation activities. With the implementation of environmental protection measures outlined below, impacts would be further reduced.

Visible Infrastructure

The extent to which SRWF structures could block or hinder the view of other underway vessels and/or the view of the coastline or any other navigation feature was examined in Appendix X. The assessment was based on the monopile foundation type, which represents the largest foundation type being considered. Geometric modeling determined that a 56 ft (17 m) vessel would not be seen from an opposite position of an individual WTG; with the addition of 36 ft (10 m) to account for uncertainty, the conservative result representative of the maximum potential for visual obstruction is an 89-ft (27-m) distance. Based on this distance, for a vessel travelling at 5 knots, the visual obstruction would last 10.5 seconds. Additionally, safety zones may be established around O&M activities on a case-by-case basis in coordination with the USCG. Visible infrastructure impacts due to operation of the Project are therefore expected to be minimal, with impacts further reduced with the implementation of environmental protection measures outlined below.

Potential impacts to HF radar systems are described in Section 4.7.5 and Appendix Y1 – *Obstruction Evaluation and Airspace Analysis / Radar and Navigational Aid Screening Study*. Appendix X determined that the Project will not affect a mariner's ability to use marked aids to navigation (ATON) or the coastline as a reference for navigation due to the SRWF's relative location to marked aids and the coastline. Each foundation will serve as an ATON for mariners as they will be large structures with required lighting and markings in conjunction with PATON permits.

Lighting and Marking

Navigation lights, markings, sound signals, and other ATON will be installed and maintained as prescribed within the PATON permit issued by the USCG for each operating WTG, and the OCS–DC. A conceptual lighting plan is included within Appendix X; this plan is based on existing USCG regulations and policy and standards promulgated by the International Association of Marine Aids to Navigation and Lighthouse Authorities in Recommendation O-139, *The Marking of Man-Made Offshore Structures* (IALA 2013). The USCG has endorsed those standards. All WTGs will be lit and marked in accordance with FAA Advisory Circular 70/7460-1L (2018) as recommended by BOEM's *Guidelines for Lighting and Marking of Structures Supporting Renewable Energy Development* (BOEM 2021). The OCS–DC and WTGs will be lit and marked in accordance with FAA and USCG requirements for aviation and navigation obstruction lighting, respectively.

CONSTRUCTION AND OPERATIONS PLAN

Site Characterization and Assessment of Impacts – Transportation and Navigation

Sunrise Wind is evaluating the implementation of methods to limit the visual impact of the aviation light, for example light dimming or the use of a radar-based ADLS (or similar system) to turn on, and off, the aviation obstruction lights in response to detection of aircraft in proximity to the wind farm, pursuant to approval by the FAA and BOEM, commercial and technical feasibility at the time of FDR/FIR approval, and dialogue with stakeholders. Appendix Y1 – *Obstruction Evaluation and Airspace Analysis / Radar and Navigational Aid Screening Study* determined that an ADLS-controlled obstruction lighting system could result in over a 99 percent reduction in system activated duration as compared to a traditional always-on obstruction lighting system. Additional information about ADLS can be found in Appendix Y1.

4.8.1.3 Proposed Environmental Protection Measures

Several environmental protection measures will reduce potential impacts to marine transportation and navigation.

- Sunrise Wind is committed to an indicative layout scenario with WTGs and the OCS–DC sited in a uniform east-west/north-south grid with 1.15 by 1.15-mi (1 by 1-nm; 1.85 by 1.85-km) spacing that aligns with other proposed adjacent offshore wind projects in the RI-MA WEA and MA WEA. This layout has been confirmed through expert analysis and the USCG (USCG 2020) to allow for safe navigation without the need for additional designated transit lanes. This layout will also provide a uniform, wide spacing among structures to facilitate search and rescue operations and is consistent with study recommendations in the USCG Massachusetts and Rhode Island Port Access Route Study (USCG 2020). Navigation lights, markings, sound signals, and other ATON (including AIS on select WTGs) will be installed and maintained as prescribed within the PATON permit issued by the USGC for each WTG, and the OCS–DC.
- A notional lighting plan is included within Appendix X based on existing USCG regulations and policy and standards promulgated by the International Association of Marine Aids to Navigation and Lighthouse Authorities in Recommendation O-139, *The Marking of Man-Made Offshore Structures* (IALA 2013). The USCG has endorsed those standards.
- The WTGs and OCS–DC will be lit and marked in accordance with BOEM and USCG requirements for aviation and navigation obstruction lighting, respectively.
- Sunrise Wind will use ADLS or related means (e.g., dimming or shielding) to limit visual impact, pursuant to approval by the FAA and BOEM, commercial and technical feasibility at the time of FDR/FIR approval, and dialogue with stakeholders. The WTGs will be lit and marked in accordance with FAA Advisory Circular 70/7460-1L (2018), as recommended by BOEM's *Guidelines for Lighting and Marking of Structures Supporting Renewable Energy Development* (BOEM 2021).
- Sunrise Wind will request, and it is expected that the USCG will establish, temporary safety zones around all marine construction activities.
- To reduce the likelihood of an allision or collision during construction, Project safety vessel(s) will be on scene to advise mariners of construction activity.
- Mariner Radio-Activated Sound Signals (MRASS) are VHF-based and are expected to be deployed in the SRWF, similar to the deployment at Block Island Wind Farm.

CONSTRUCTION AND OPERATIONS PLAN

Site Characterization and Assessment of Impacts – Transportation and Navigation

- To the extent feasible, the SRWEC and IAC will typically target a burial depth of 3 to 7 ft (1 to 2 m). The target burial depth will be determined based on an assessment of seabed conditions, seabed mobility, the risk of interaction with external hazards such as fishing gear and vessel anchors, and a site-specific Cable Burial Risk Assessment. The cables include various protective armoring and sheathing to protect the cable from external damage and keep it watertight. Cable protection measures will be employed where cable burial depth is not adequate. Vessel operators are expected to follow the International Regulations for Preventing Collisions at Sea 1972 (COLREGs) Rule 5 that states “at all times maintain a proper lookout by sight and hearing as well as by all available means appropriate in the prevailing circumstances and conditions so as to make a full appraisal of the situation and risk of collision.”
- Sunrise Wind will require operational AIS on all vessels associated with construction, O&M, and decommissioning of the Project, pursuant to USCG and AIS carriage requirements. AIS will be used to monitor the number of vessels and traffic patterns for analysis and compliance with vessel speed requirements.
- The WTGs and OCS–DC will have a marked air gap to aid in the avoidance of an allision incident.
- Emergency procedures will be developed and reviewed with relevant agencies, including the USCG, to ensure that response plans are adequate and properly resourced.
- A Project construction guideline will define a window related to wind, sea state, and other constraints under which construction activities will start/continue or will stop/be discontinued. Conditions and forecasts will be monitored to enable proactive planning and early warning of future unsafe conditions. A 24-hr operational monitoring center is planned to verify safe conditions are being maintained and will have the ability to remotely operate and shut down WTGs if required.
- During construction and O&M, notices to mariners will be published on, and broadcasted through, regular radio communications, online information will be available for mariners, and notices to mariners from the USCG will occur.
- Frequent updates on offshore activities to fishing operators will be provided via online updates, twice-daily updates on VHF channels, and through Fisheries Liaisons and local fisheries representatives based in regional ports.
- Information on the exact locations of newly installed Project components, including structures, cable, and cable protection, will be provided to NOAA to include on navigation charts to reduce any potential impact to marine navigation. The WTGs themselves may also serve as an information navigation aid for mariners, particularly at night because they will be lit and marked.
- A comprehensive communication plan will be implemented during offshore construction to inform all mariners, including commercial and recreational fishing vessels, and recreational boaters, of construction activities and Project-related vessel movements. Communication will be facilitated through a Project website, public notices to mariners and vessel float plans, and a Fisheries Liaison. Sunrise Wind will submit information to the USCG to issue Local Notice to Mariners during offshore installation activities.

CONSTRUCTION AND OPERATIONS PLAN

Site Characterization and Assessment of Impacts – Transportation and Navigation

4.8.2 Land Transportation and Navigation

This section describes the affected environment and potential effects from the construction and operation of the Project as they relate to land transportation and navigation. The description of the affected environment and assessment of potential impacts were developed by reviewing current public data sources related to land transportation and navigation (e.g., NYSDOT Traffic Volume Reports). A description of land transportation around the Onshore Facilities components of the Project Area is provided below, followed by an evaluation of potential Project-related impacts.

4.8.2.1 Affected Environment

The affected environment for land transportation and navigation is defined as the states, counties, cities, and towns that have the potential to be directly affected by the construction, O&M, and decommissioning of the Project. These areas include the Town of Brookhaven, Suffolk County, New York, where the Landfall and ICW Work Areas, Onshore Transmission Cable and Onshore Interconnection Cable, and OnCS-DC will be located. Since the SRWF and SRWEC are located offshore and in NYS waters, they do not involve land transportation, and thus only Onshore Facilities are addressed in this section.

As previously discussed, the Project will require support from temporary construction laydown yard(s) and construction port(s). Since proposed uses will be confined to the existing port facilities and will be consistent with the current transportation and traffic patterns occurring at these locations, no impacts to land transportation and navigation are anticipated in connection to the ports.

Onshore Facilities

Two public parking lots will be utilized for construction of the Onshore Transmission Cable. The cable will originate at the Landfall HDD TJB on the eastern portion of the paved Smith Point County Park parking lot. It will then be routed across the ICW via an ICW HDD to a paved parking lot within the Smith Point Marina, along East Concourse Drive.

The major roadways within the vicinity of the Onshore Facilities include the William Floyd Parkway (County Route 46), Montauk Highway (County Route 80), Horseblock Road (County Route 16), and the LIE (I-495) South Service Road. Local and county roads that will be used in support of the Project include Surrey Circle, Mastic Boulevard, Francine Place, Revilo Avenue, Victory Avenue, Manor Road, Waverly Avenue, Long Island Avenue, and Union Avenue.

According to the NYSDOT Traffic Data Report for New York State, vehicle traffic patterns are assessed using a statewide traffic monitoring system currently consisting of 177 permanent continuous count stations that collect volume, speed, vehicle classification, and weigh-in-motion data daily. These sites are located throughout the state to monitor general traffic trends, and this data is further used to estimate Annual Average Daily Traffic (AADT) for local, state, and interstate roadways (NYSDOT 2014).

CONSTRUCTION AND OPERATIONS PLAN

Site Characterization and Assessment of Impacts – Transportation and Navigation

These roads have varying amounts of typical daily traffic. Based on NYSDOT records for 2018, vehicle traffic for William Floyd Parkway, from County Route 75 to the intersection with Montauk Highway, was estimated to have an AADT of 109,605 vehicles. Victory Avenue was estimated to have an AADT of 5,500 vehicles. Horseblock Road, from the LIE South Service Road to Yaphank Avenue (County Route 21), had an AADT of 80,306 vehicles. Finally, AADT on the LIE South Service Road was approximately 238,038 vehicles from the underpass at Nicolls Road to the Route 112 underpass at Horseblock Road (NYSDOT 2018).

Multiple public bus routes occur in the vicinity of the Onshore Facilities (SCT 2012). In addition, the LIRR is proximal to the Onshore Facilities. The LIRR is a commuter rail network that serves the length of Long Island, stretching from Manhattan to Montauk (MTA 2020).

4.8.2.2 Potential Impacts

Construction, O&M, and decommissioning activities associated with the Onshore Facilities have the potential to cause direct impacts to land transportation and navigation. IPFs associated with the construction and O&M phases of the Project are identified on Figure 4.8.2-1 and described separately, by phase, in the following sections. For the decommissioning phase of the Project, impacts are anticipated to be similar to or less adverse than those described for construction; therefore, impacts from decommissioning are not addressed separately in this section.

CONSTRUCTION AND OPERATIONS PLAN

Site Characterization and Assessment of Impacts – Transportation and Navigation

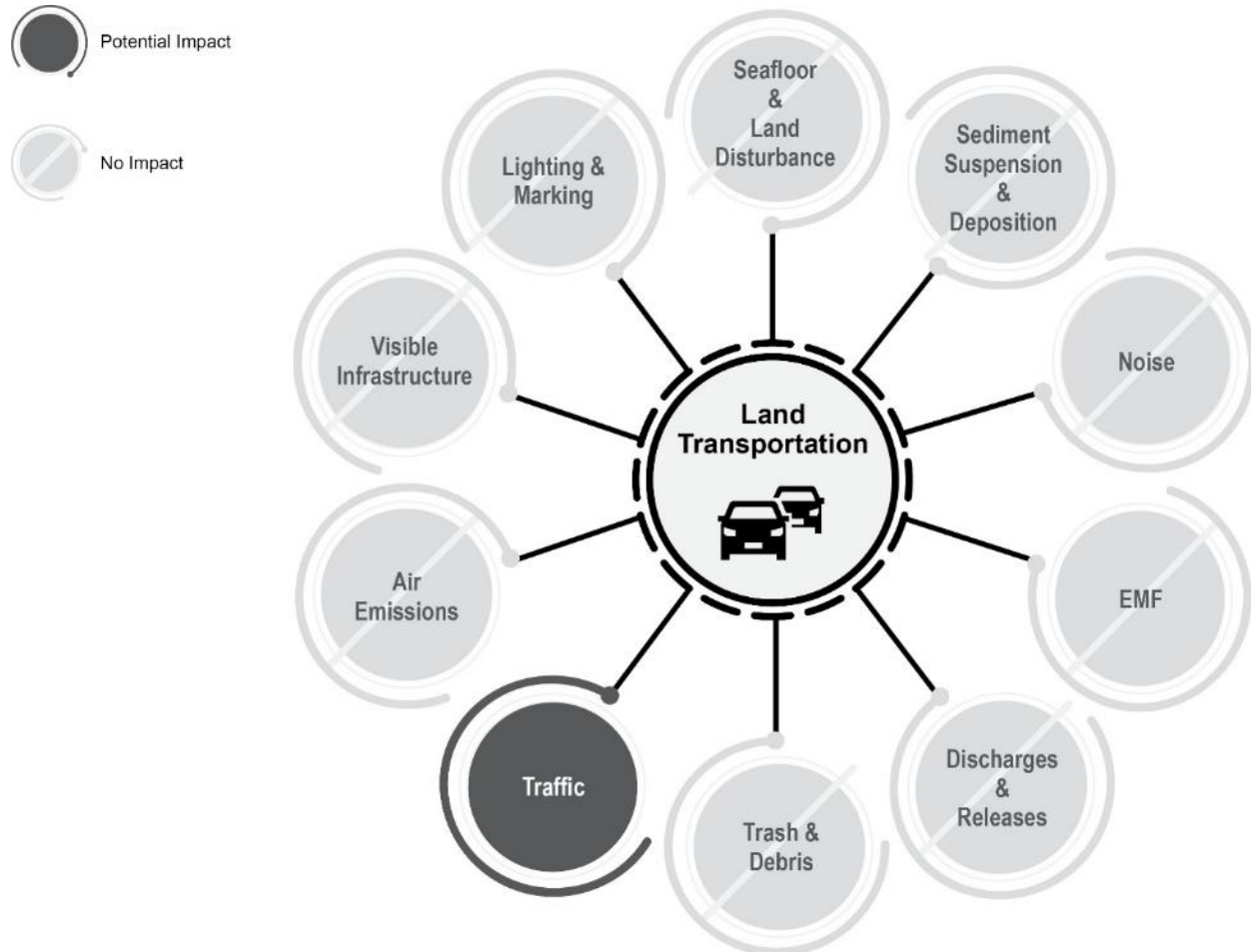

Figure 4.8.2-1 Impact-Producing Factors on Land Transportation

Onshore Facilities

The Onshore Facilities have been designed to utilize existing transportation ROWs to the maximum extent practicable. The Landfall and ICW Work Areas have been sited in public areas consisting of paved parking lots, and both the Onshore Transmission Cable and Onshore Interconnection Cable have been sited within existing roads and/or utility ROWs to the extent feasible. The location for the OnCS-DC is adjacent to existing roadways and developed areas.

Construction

Traffic

Temporary impacts to land transportation in the Town of Brookhaven may occur during construction of the Onshore Facilities due to temporary reduction in access on public roadways and parking lots. The level of impact to land transportation will depend on the location, the construction methods at the specific location, and the season in which the construction is occurring.

CONSTRUCTION AND OPERATIONS PLAN

Site Characterization and Assessment of Impacts – Transportation and Navigation

Construction of the Landfall HDD and portions of the Onshore Transmission Cable will occur in a public parking lot associated with Smith Point County Park. The HDD methodology will require temporary use of the Landfall Work Area where HDD construction activities will occur. The Onshore Transmission Cable will also be installed within the paved Smith Point County Park parking lot between the TJBs and William Floyd Parkway. Access will be temporarily restricted to portions of the parking lot during construction activities. Installation via HDD or other subsurface installation techniques generally minimize impacts to the ground surface and above-ground activities. Construction of the Landfall HDD is expected to occur outside peak public recreation periods to minimize impacts to local transportation and traffic (see Section 3.2.2).

The ICW HDD is planned within locations occupied by recreational areas within Smith Point County Park and the parking lot associated with the Smith Point Marina. Access to the recreational areas and the Smith Point Marina parking lot may be restricted to portions of the parking lot during construction activities. The ICW HDD alignment has also been sited west of the William Floyd Bridge, which will be undergoing replacement in the near future according to Suffolk County DPW (DPW). Sunrise Wind has coordinated with DPW on available constructability data and construction schedules and has considered feedback from DPW in the design of the ICW HDD. Sunrise Wind will continue ongoing consultations with DPW to ensure ICW HDD alignment does not encroach on the workspace for the William Floyd Bridge replacement. Construction of the ICW HDD is expected to occur outside peak public recreation periods to minimize impacts to local transportation and traffic (see Section 3.2.2). The HDD crossing of the Carmans River will utilize the paved shoulder along Victory Avenue and an area on Southaven County Park land. Installation via HDD will generally minimize impacts to the ground surface and aboveground activities.

Construction of the Onshore Transmission Cable and Onshore Interconnection Cable will involve site preparation, duct bank installation, cable installation, cable jointing, final testing, and site restoration with additional steps associated with HDD and other trenchless crossing methods. Installation of the Onshore Transmission Cable will generally require excavation of a trench within a temporary disturbance corridor. The Onshore Transmission Cable will be installed within a concrete duct bank buried to a depth consistent with local utility standards. Construction of the Onshore Transmission Cable will occur along existing transportation corridors, requiring temporary isolated and/or partial road closures that may result in potential traffic delays, congestion, and narrow roadways. These impacts would be localized and temporary. Transportation of construction equipment and materials for the Project will not block or significantly slow traffic on major roadways for long periods of time. Roadways will not be blocked to local vehicular traffic for extended periods of time. No trenches or holes created during construction will be left open or unsecured during inactive construction. Construction of the Onshore Transmission Cable, Onshore Interconnection Cable, and OnCS–DC is expected to occur within an approximately 2-year period (see Section 3.2.2).

The Onshore Transmission Cable will require the crossing of a major roadway (State Route 27); multiple crossings of one railroad (the LIRR); and two waterways (ICW and Carmans River). Crossings of these features will require areas of additional temporary disturbance to support the setup of drilling rigs and layout of equipment. To minimize impacts to local traffic, several trenchless crossings are planned along the route for the Onshore Transmission Cable, including at the LIRR Sunrise Highway, and Carmans River.

CONSTRUCTION AND OPERATIONS PLAN

Site Characterization and Assessment of Impacts – Transportation and Navigation

In general, trenchless crossings under roadways, railways, and waterbodies avoids impacts to these features, as well as the transportation activities associated with them.

The Project will cross the LIRR at two locations, the first along the LIRR Montauk Branch at Church Road and the second along the LIRR Ronkonkoma Branch at Manor Road. Installation of the Onshore Transmission Cable is not anticipated to impact normal LIRR operations. All construction activities will conform to applicable standard safety practices. Open trenches will be secured with barricades, and the active work areas will be fenced off. At the LIRR, flashing lights may be installed. An inter-track barrier system will also be implemented to prevent track fouling, pursuant to the requirements of Title 49 Part 214 of the CFR.

Six public bus routes will be crossed by the Onshore Transmission Cable including Patchogue RR – Medford (7B), Patchogue – RR – Port Jefferson (S61), Patchogue – Smith Haven Mall (S63), Patchogue – Riverhead (S66), Patchogue – Center Moriches (S68) and Suffolk Clipper (S110). It is possible that construction activities may result in temporary lane or road closures along these roadways and bus routes.

Construction of the OnCS–DC will involve surveys and protection of sensitive areas, clearing and grading, foundation and equipment installation, site restoration, and commissioning. Temporary laydown yards may be utilized to support the staging of necessary equipment and materials for development of the OnCS–DC. The locations will be approved by the applicable regulatory agencies prior to utilization, and generally will be confined to locations containing open land or previously disturbed commercial or industrial sites with existing roadway access, such that no or minimal site improvements are required.

Sunrise Wind has consulted with local entities including the DPW, the Town of Brookhaven Department of Public Works, and the NYSDOT (Region 10) regarding route location, traffic management, construction methodology and time of year considerations (see Appendix A and Section 2.2.1). Moreover, as required by New York State Law, Sunrise Wind will develop a Maintenance and Protection of Traffic (MPT) plan within the Project's Environmental Management and Construction Plan (EM&CP) that describes measures to minimize and mitigate for potential impacts to land transportation to the maximum extent practicable during construction. The MPT will also describe the commitment to continued consultation with stakeholders regarding traffic and transportation management before and throughout construction. The MPT plan will be submitted to NYDPS for review and approval during the Article VII review process.

As described in the MPT, during onshore construction, Sunrise Wind will use commercially-reasonable efforts to maintain at least one travel lane of traffic in the section(s) of the road(s) in which construction crews are working; however, during certain periods of work, temporary road closures may be necessary. To allow for traffic to move safely, traffic control measures, such as signage and traffic flaggers, will be used wherever necessary. Traffic control measures to address traffic flow in and around construction areas will be developed as part of the MPT plans. Proper traffic control measures will be utilized to ensure the movement of traffic and to mitigate impacts on bus route schedules. Access to bus stops will also be maintained or temporarily relocated during construction, thereby minimizing impacts to bus stops and bus stop access.

CONSTRUCTION AND OPERATIONS PLAN

Site Characterization and Assessment of Impacts – Transportation and Navigation

All construction-related impacts to roadways and parking lots will be restored to pre-construction conditions in accordance with *NYSDOT Standard Specifications for Construction and Materials* and in coordination with local entities. For roadway and parking lot installations, this will include the surface repaving, including installment of the road subbase and base layers followed by the surface layer (i.e., concrete or asphalt). Locations used for HDD work areas and temporary laydown yards will be restored to pre-existing conditions in accordance with landowner requests and permit requirements.

Operations and Maintenance

Traffic

Because the Onshore Transmission Cable and Onshore Interconnection Cable will be installed entirely underground, it is not anticipated that operation of the Project will have an impact on local traffic during O&M. The Onshore Transmission Cable and Onshore Interconnection Cable will require very little maintenance, if any; these components are designed such that inspection and maintenance during operations will not be required unless a fault or failure occurs. Failures onshore are only anticipated in the event of damage from outside influences such as unexpected digs from other parties. In the unlikely event of such a case, impact on existing traffic volumes will be short-term and localized.

The OnCS–DC will be unmanned during routine operations and will be inspected regularly based on manufacturer-recommended schedules. Personnel will be on site as necessary for any maintenance or repairs.

4.8.2.3 Proposed Environmental Protection Measures

Sunrise Wind will implement the following environmental protection measures to reduce potential impacts on land transportation and navigation. These measures are based on protocols and procedures successfully implemented for similar offshore wind projects.

- To minimize impacts to local traffic, several trenchless crossings are planned along the route for the Onshore Transmission Cable, including at the LIRR.
- The construction of the Landfall and ICW HDD is expected to occur outside the summer tourist season, which is generally between Memorial Day and Labor Day. The construction schedule for the remaining Onshore Facilities will be designed to minimize impacts to the local communities to the extent feasible.
- All construction-related impacts to roadways and parking lots will be restored to pre-construction conditions in accordance with *NYSDOT Standard Specifications for Construction and Materials* and in coordination with local entities. Locations used for HDD work areas and temporary laydown yards will be restored to pre-existing conditions in accordance with landowner requests and permit requirements.
- Sunrise Wind will coordinate with local authorities and develop an MPT plan as part of the Project's EM&CP to minimize potential traffic impacts during construction.

CONSTRUCTION AND OPERATIONS PLAN

Site Characterization and Assessment of Impacts – Transportation and Navigation

- To allow for traffic to move safely, traffic control measures, such as signage and traffic flaggers, will be used wherever necessary. Traffic control measures to address traffic flow in and around construction areas will be developed as part of the MPT plans. Proper traffic control measures will be utilized to ensure the movement of traffic and to mitigate impacts on bus route schedules. Access to bus stops will also be maintained or temporarily relocated during construction, thereby minimizing impacts to bus stops and bus stop access.
- Because the Onshore Transmission Cable and Onshore Interconnection Cable will be installed entirely underground, it is not anticipated that operation of the Project will have an impact on local traffic during O&M. The Onshore Transmission Cable and Onshore Interconnection Cable will require very little maintenance, if any.

4.8.3 Air Transportation and Navigation

This section describes the affected environment and potential effects from the construction and operation of the Project as they relate to air transportation and navigation. The description of the affected environment and assessment of potential impacts were developed by reviewing current public data sources related to air transportation and navigation, including state and federal agency-published papers and databases; online data portals and mapping databases (e.g., data from the FAA for airport locations, published instrument approach and departure procedures, visual flight rule operations, en route operations), and minimum vectoring and minimum instrument altitudes. Correspondence and consultation with federal and state agencies is forthcoming and will occur prior to agency consultation on the COP. A description of air transportation in the Project Area is provided below, followed by an evaluation of potential Project-related impacts. Additional details concerning air transportation are presented in Appendix Y1 and Y2.

4.8.3.1 Affected Environment

The FAA has jurisdiction to review and certify that structures located within US territorial waters and greater than 199 ft (61 m) above ground level do not have adverse effects on the safety or efficient utilization of navigable airspace within 13.8 mi (12 nm; 22 km) of the shoreline (49 USC § 44718 and 14 CFR Part 77). Beyond this distance, BOEM assumes responsibility for review. Structures that fall under FAA and/or BOEM jurisdiction must also be reviewed by the DoD and the Department of Homeland Security to identify any potential interference with operations and/or radar systems. The SRWF is more than 13.8 mi (12 nm; 22 km) from shore and, therefore, is not subject to FAA review, but are subject to review by BOEM, DoD, and the Department of Homeland Security. A Project introduction submittal and Informal Review Request was sent to the DoD Military Aviation and Installation Assurance Siting Clearinghouse on July 24, 2020 to start the coordination process.

In support of the assessment of the Project's potential effects on air transportation and navigation, Appendix Y1 includes an analysis for the maximum wind turbine tip height to identify potential impacts on civilian aviation or military activities, and to screen for radar sites used by air traffic control, national defense (air defense and homeland security), and weather operations.

CONSTRUCTION AND OPERATIONS PLAN

Site Characterization and Assessment of Impacts – Transportation and Navigation

Appendix Y2 includes an evaluation of historical air traffic data, including the number of flights that could be affected by the presence of WTGs and the OCS–DC. This includes evaluation of the number of operations that are likely to activate obstruction lights controlled by ADLS.

Since the SRWEC will be installed below the seabed, the SRWEC is not expected to affect air transportation or navigation, and thus is not addressed in this section.

Regional Overview

There are multiple public and private-use airports located within the general proximity of the Project, including sites in New York, Massachusetts, Rhode Island, and Connecticut (Figure 4.8.3-1). Brookhaven Calabro (HWV) airport is the nearest airport to the Landfall and Long Island MacArthur (ISB) is the nearest airport to the OnCS–DC.

Multiple civilian and military surveillance radar systems are located onshore and in the vicinity of the Project. Specifically, the proposed WTGs may be within the line of sight of the Falmouth Airport Surveillance Radar model-8 (ASR-8), Nantucket ASR-9, and the Providence ASR-9. These systems are jointly utilized by the FAA and DoD to coordinate and surveil various air traffic and air defense operations. Additionally, the DoD operates an early warning radar (referred to as the Precision Acquisition Vehicle Entry/Phased Array Warning System) located at Joint Base Cape Cod; where the proposed WTGs may also be within line of sight.

This page intentionally left blank

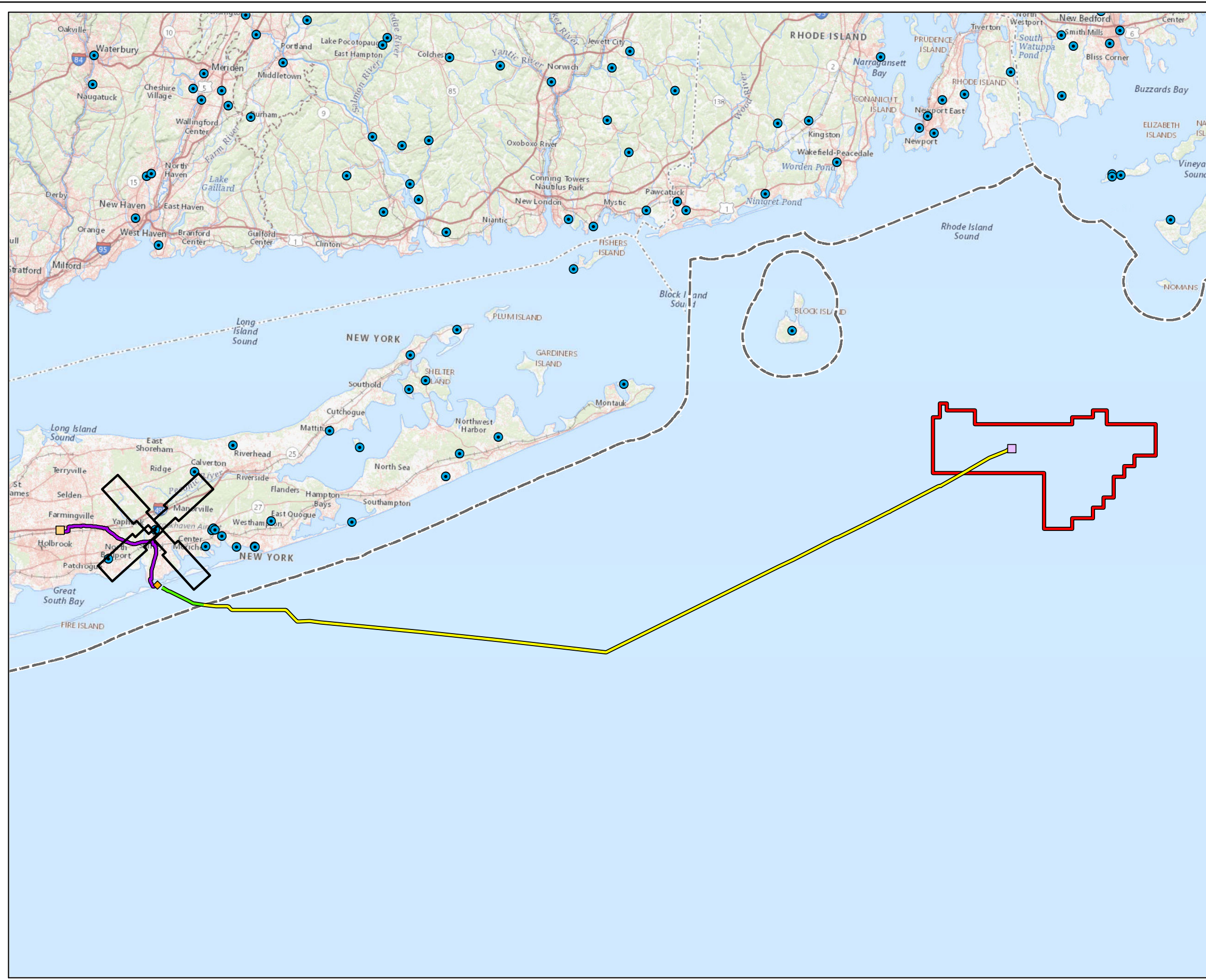

Figure 4.8.3-1
Existing Airports Within
Vicinity of Project

**Sunrise
Wind**

Powered by
**Ørsted &
Eversource**

Legend

- Sunrise Wind Farm (SRWF)
- Offshore Converter Station (OCS-DC)
- ◆ SRWECS Landfall Location
- Union Avenue Site
- Sunrise Wind Export Cable (SRWECS-OCS)
- Sunrise Wind Export Cable (SRWECS-NYS)
- Onshore Transmission Cable
- LIE Service Road Route
- 3-nm State Waters Boundary
- Existing Airports
- Instrument Approach Area

Note
Routes are indicative and subject to engineering design changes.

Sources
1. Base map: USGS The National Map

Date	12/18/2020 Revised: 6/1/2021
Project Number	2028113199
Prepared By	PB
Reviewed By	LJ

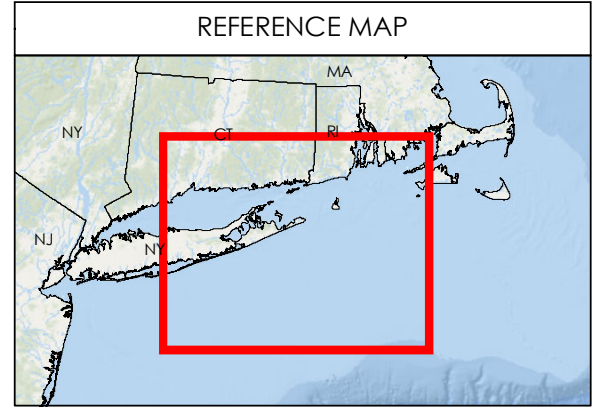
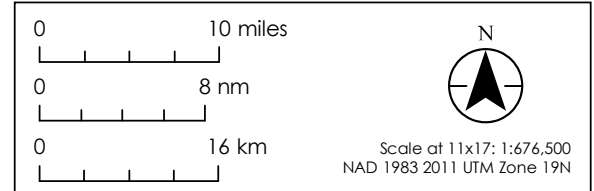

This page intentionally left blank

CONSTRUCTION AND OPERATIONS PLAN

Site Characterization and Assessment of Impacts – Transportation and Navigation

Sunrise Wind Farm

WTGs and the OCS–DC will be located in federal waters within BOEM jurisdiction, and will be sited in a uniform east-west/north-south grid with 1.15 by 1.15-mi (1 by 1-nm; 1.85 by 1.85-km) spacing conforming to the USCG recommendation for minimum spacing between structures along a search path (USCG 2020) and visual flight rules in 14 CFR 91.155 specifying a minimum of 0.5-mi (0.43-nm, 0.8-km) visibility in daytime without clouds.

The maximum height for the WTG will be between 636 ft and 968 ft (194 m and 295 m) AMSL (Table 3.3.8-1), depending on the turbine model selected. The maximum height will be up to 361 ft (110.0 m) total structure height from lowest astronomical tide (including lightning protection and ancillary structures) for OCS–DC.

Onshore Facilities

Commercial and private air transportation services are offered from several locations in the vicinity of Onshore Facilities, including the Brookhaven Airport, CMC Atlantic LLC Heliport, Bayport Aerodrome and Long Island MacArthur Airport. The approximate distances from the closest point of the Onshore Facilities to these services are listed in Table 4.8.3-1.

Table 4.8.3-1 Summary of Airports in the Vicinity of Onshore Facilities

Name	Type	Direction (Onshore Transmission Cable)	Distance from LIE Service Road Centerline (miles)	Distance from Peconic Avenue Centerline (miles)	Direction (OnCS DC)	Distance OnCS–DC (miles)
Brookhaven	Airport	north	1.43	1.43	northeast	10.16
CMC Atlantic LLC	Heliport	south	2.47	2.47	southeast	5.95
Bayport Aerodrome	Airport	south	3.76	3.76	south	3.86
Long Island MacArthur	Airport	southwest	2.30	2.31	southwest	2.27

4.8.3.2 Potential Impacts

Construction, O&M, and decommissioning activities associated with the Project have the potential to cause direct impacts to air transportation and navigation. IPFs associated with the construction and O&M phases of the Project are identified on Figure 4.8.3-2 and described separately, by phase, in the following sections. IPFs addressed in the following section include traffic, visible infrastructure and lighting and marking. For the decommissioning phase of the Project, impacts are anticipated to be similar to or less adverse than those described for construction; therefore, impacts from decommissioning are not addressed separately in this section.

CONSTRUCTION AND OPERATIONS PLAN

Site Characterization and Assessment of Impacts – Transportation and Navigation

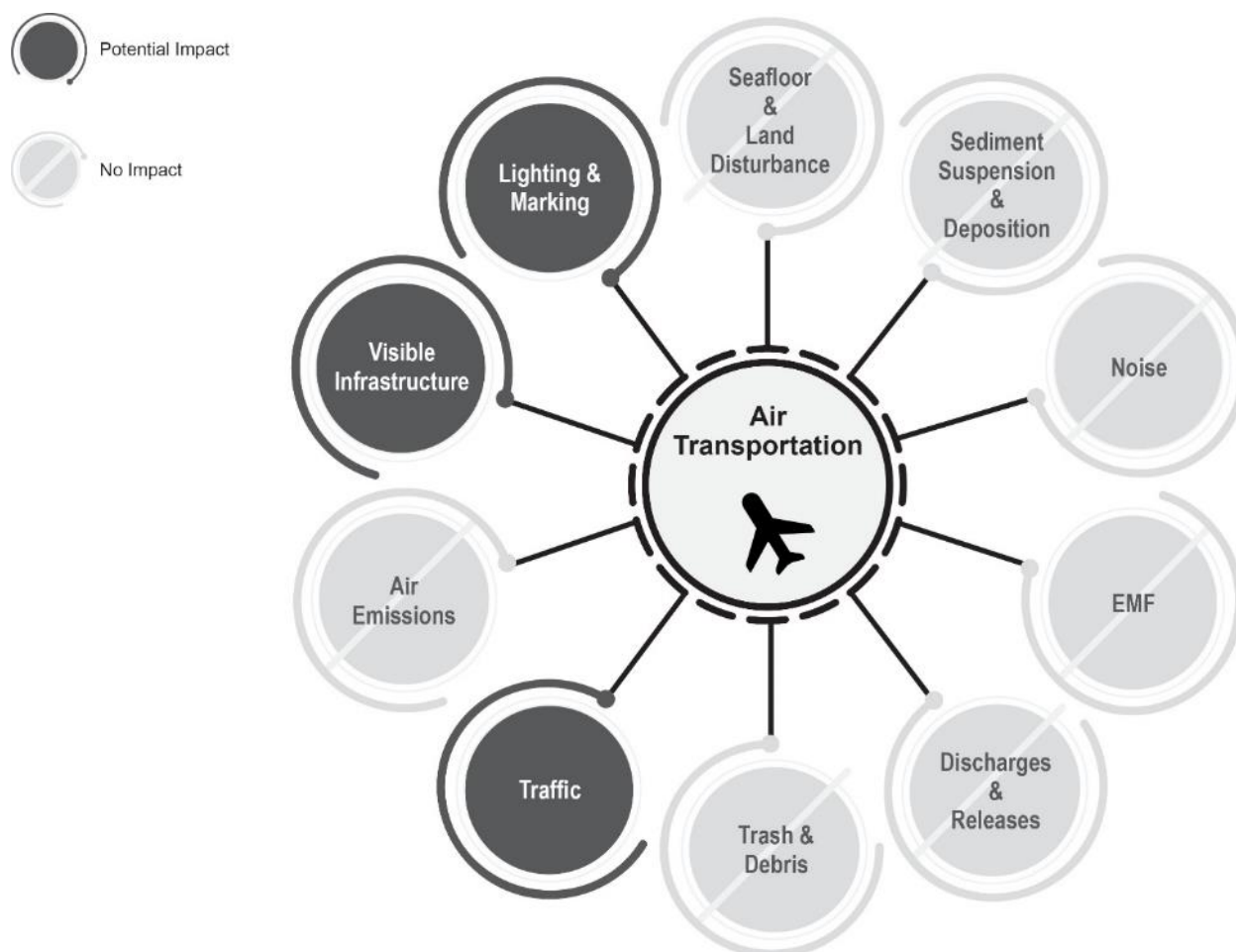

Figure 4.8.3-2 Impact-Producing Factors on Air Transportation and Navigation

Sunrise Wind Farm

Based on the IPFs illustrated in Figure 4.8.3-2, during construction, temporary impacts from increased traffic, visible infrastructure, and lighting and marking will occur to existing air transportation and navigation. Similarly, during O&M of the SRWF, impacts from increased traffic, visible infrastructure, and lighting and marking will occur to air transportation and navigation.

Construction

IPFs resulting in potential impacts on air transportation and navigation from construction of the SRWF are illustrated in Figure 4.8.3-2 and discussed below.

Traffic

Helicopters may be used for crew changes during installation of the WTGs. In addition, vessels anticipated to be present during construction include construction barges, support tugs, jack-up rigs, supply/crew vessels, and cable laying vessels. Details on the type and number of vessels expected to operate for the construction of the SRWF are included in Table 3.3.10-3.

CONSTRUCTION AND OPERATIONS PLAN

Site Characterization and Assessment of Impacts – Transportation and Navigation

However, not all vessels presented in Table 3.3.10-3 are expected to be operating at one given time, and the increase in construction vessel traffic will be temporary. Appendix Y1 includes evaluation of potential airspace impacts resulting from the transport of the offshore materials (e.g., WTG towers) and equipment (e.g., cranes) to and from the SRWF. Given the short-term and temporary nature of construction traffic activity expected, impacts are likely to be minimal.

Visible Infrastructure

Although the gradual development of the WTG structures will occur during the construction phase, impacts from visible infrastructure associated with the fully installed WTG structures are assessed under O&M below.

Lighting and Marking

The appropriate lighting and marking of the OCS–DC and WTGs will be installed and activated as the structures are gradually put into place; therefore, lighting within the SRWF will increase as construction of the SRWF progresses. For additional information on lighting of installed and operational structures, refer below to the O&M Lighting and Marking section and Section 3.5.7.

Operations and Maintenance

IPFs resulting in potential impacts on air transportation and navigation from O&M of the SRWF are illustrated in Figure 4.8.3-2 and discussed below.

Traffic

During O&M, helicopters and unmanned aircraft systems may be used to support O&M, as described in Section 3.5.5. The type and number of will vary over the operational lifetime of the Project. All aviation operation, including flying routes and altitude, will be aligned with relevant stakeholders (e.g., the FAA). Flights may be restricted to daylight operations when visibility is good. Sunrise Wind is continuing to evaluate the potential for impact, or lack thereof, on flight paths and will coordinate with the FAA.

Visible Infrastructure

Appendix Y1 includes a summary of aeronautical effects of the presence of the WTGs and OCS–DC based on height and location, compared to other uses in the vicinity of the SRWF, including potential proximity to radar systems, as discussed in Section 4.7.5. The operational usage of radar systems in the vicinity of the SRWF is not publicly available, and Sunrise Wind is continuing to evaluate the potential for impact, or lack thereof, on radar systems and will coordinate with the FAA and the DoD.

Lighting and Marking

All WTGs will be lit and marked in accordance with FAA Advisory Circular 70/7460-1L (2018) as recommended by BOEM's *Guidelines for Lighting and Marking of Structures Supporting Renewable Energy Development* (BOEM 2021). The OCS–DC will be lit and marked in accordance with FAA and USCG requirements for aviation and navigation obstruction lighting, respectively.

CONSTRUCTION AND OPERATIONS PLAN

Site Characterization and Assessment of Impacts – Transportation and Navigation

Sunrise Wind is evaluating the implementation of methods to limit the visual impact of the aviation light, for example light dimming or the use of a radar-based ADLS (or similar system) to turn on, and off, the aviation obstruction lights in response to detection of aircraft in proximity to the wind farm, pursuant to approval by the FAA and BOEM, commercial and technical feasibility at the time of FDR/FIR approval, and dialogue with stakeholders. Appendix Y2 provides results of a Project-specific ADLS study.

Onshore Facilities

The construction of the Onshore Facilities is not anticipated to affect air transportation and navigation. IPFs resulting in potential impacts on air transportation and navigation from O&M of the Onshore Facilities are illustrated in Figure 4.8.3-2 and discussed below.

Operations and Maintenance

Visible Infrastructure

The operations of the Onshore Facilities are not anticipated to affect air transportation or communications. The Onshore Transmission Cable will be installed entirely underground and will not include any overhead utility poles. The maximum height of the lightning masts on the OnCS–DC will be 100 ft (30.5 m); therefore, vertical infrastructure associated with the OnCS–DC will not interfere with air traffic or communications, per industry standards regarding electrical interference.

4.8.3.3 Proposed Environmental Protection Measures

Sunrise Wind will implement the following environmental protection measures to reduce potential impacts on air transportation and navigation. These measures are based on protocols and procedures successfully implemented for similar offshore wind projects.

- Sunrise Wind is committed to an indicative layout scenario with WTGs and the OCS–DC sited in a uniform east-west/north-south grid with 1.15 by 1.15-mi (1 by 1-nm; 1.85 by 1.85-km) spacing that aligns with other proposed adjacent offshore wind projects in the RI-MA WEA and MA WEA. This layout has been confirmed through expert analysis and the USCG (USCG 2020) to allow for safe navigation without the need for additional designated transit lanes. This layout will also provide a uniform, wide spacing among structures to facilitate search and rescue operations and is consistent with study recommendations in the USCG Massachusetts and Rhode Island Port Access Route Study (USCG 2020). The WTGs and OCS–DC will be lit and marked in accordance with BOEM and USCG requirements for aviation and navigation obstruction lighting, respectively.
- The WTGs will be lit and marked in accordance with FAA Advisory Circular 70/7460-1L (2018), as recommended by BOEM's *Guidelines for Lighting and Marking of Structures Supporting Renewable Energy Development* (BOEM 2021).
- Sunrise Wind will use ADLS or related means (e.g., dimming or shielding) to limit visual impact, pursuant to approval by the FAA and BOEM, commercial and technical feasibility at the time of FDR/FIR approval, and dialogue with stakeholders. The Onshore Transmission Cable and Onshore Interconnection Cable will not include any overhead utility poles.

CONSTRUCTION AND OPERATIONS PLAN

Site Characterization and Assessment of Impacts – Summary of Potential Impacts and Environmental Protection Measures

4.9 Summary of Potential Impacts and Environmental Protection Measures

This section identifies the potential impacts anticipated from the implementation of activities described in this COP and provides a summary of the proposed environmental protection measures that will be implemented to avoid and minimize these potential impacts.

The information presented in Section 4.0 was developed and presented to support review under NEPA and, as appropriate, the ESA, MMPA, MBTA, CZMA, NHPA, and the MSFCMA.

The scopes of the resource characterizations and impact assessments presented in Section 4.0 were based upon the requirements set forth in 30 CFR 585.627 but also guided by input from federal and state agencies and other public and private stakeholders in the region. Physical, biological, cultural, visual, socioeconomic, and transportation and navigation resources were characterized based upon extensive desktop studies, targeted field studies, predictive modeling, and data analysis. These assessments provided a detailed background on the condition of these resources in the affected environment. Desktop studies included literature reviews; examination of publicly available datasets; direct communication with academic and government science researchers; and consultation with state and federal government entities. The New York Ocean Action Plan, the Massachusetts Ocean Management Plan, and the OSAMP provided important insight on environmental conditions and existing human activities in and near the Project Area. The resource characterizations also relied on the material published in previous BOEM NEPA documents, such as the *Final Programmatic Environmental Impact Statement (PEIS) for Alternative Energy Development and Production and Alternate Use of Facilities on the Outer Continental Shelf* (BOEM 2007).

As demonstrated by the impact assessments presented throughout Section 4.0, the type and degree of potential impacts from proposed Project activities varies based on the characteristics of the resource (e.g., presence/absence, conservation status, abundance) and the IPF that may affect each resource. Where relevant and distinct, potential impacts are discussed separately for the SRWF, SRWEC–OCS, SRWEC–NYS, and Onshore Facilities. If measures are proposed to avoid and minimize potential impacts, the impact assessment included consideration of these environmental protection measures.

Sunrise Wind has incorporated avoidance and minimization of environmental impacts throughout the site selection and design process. Table 4.8.3- identifies which potential IPFs may impact which resources and describes the corresponding environmental protection measures and BMPs that Sunrise Wind will adopt to minimize these potential impacts. Although organized by resource in Table 4.8.3-2, many of the measures for one resource will indirectly benefit and/or protect other resources; for the sake of simplicity, these measures are not necessarily repeated for all subsequent resources.

Most potential impacts to affected physical, biological, visual, cultural, socioeconomic, and transportation and navigation resources will be minimized and/or mitigated. Resources that may be impacted by the SRWF, SRWEC, and Onshore Facilities are expected to recover given that impacts will be limited temporally and/or spatially. Post-construction environmental monitoring of various resources will take place and will include, at a minimum, coordination and data sharing with regional monitoring efforts. Monitoring plans will be developed in coordination with the relevant agencies prior to construction.

This page intentionally left blank

CONSTRUCTION AND OPERATIONS PLAN

Site Characterization and Assessment of Impacts – Summary of Potential Impacts and Environmental Protection Measures

Table 4.8.3-2 Summary of Potential Impacts and Environmental Protection Measures, by Resource

Resource	IPF Associated with Project	Environmental Protection Measures
Physical Oceanographic and Meteorological Conditions	<ul style="list-style-type: none"> Visible Infrastructure 	<ul style="list-style-type: none"> Potential impacts to physical oceanographic and meteorological conditions are considered negligible and, therefore, environmental protection measures are not necessary.
Geological Resources	<ul style="list-style-type: none"> Seafloor and Land Disturbance Sediment Suspension and Deposition 	<ul style="list-style-type: none"> The SRWF and SRWEC will avoid identified shallow hazards, to the extent feasible. To the extent feasible, installation of the SRWEC and IAC will occur using methods such as mechanical plow, jet plow, and/or mechanical cutter for installation of the IAC and SRWEC will minimize impacts to surficial geology, compared to open-cut dredging. Use of monopile and piled jacket foundations with associated scour protection will minimize impacts to surficial geology, compared to other foundation types. Dynamic positioning (DP) vessels will be used for installation of the IAC and SRWEC to the extent practicable. Use of DP vessels will minimize impacts to the seabed, compared to use of a vessel relying on multiple anchors. The SRWEC Landfall will be installed via horizontal directional drilling (HDD) to avoid impacts to the nearshore zones and surficial geologic resources. The Onshore Transmission Cable will also be installed via HDD under the Intracoastal Waterway (ICW) to avoid impacts to coastal resources; HDD and trenchless methods will also be used elsewhere onshore, where appropriate, to minimize impacts to surface locations and resource areas. Onshore Facilities are primarily sited within previously disturbed and developed areas (e.g., roadways, rights-of-way [ROW], developed industrial/commercial areas) to the extent feasible, to minimize impacts to undisturbed surficial geology. A Stormwater Pollution Prevention Plan (SWPPP), including erosion and sedimentation control best management practices (BMPs) and revegetation measures, will be implemented to minimize potential water quality impacts and limit sediment drift, transport, and deposition from construction and O&M of the Onshore Facilities.
Water Quality	<ul style="list-style-type: none"> Sediment Suspension and Deposition Discharges and Releases Trash and Debris 	<ul style="list-style-type: none"> Accidental spill or release of oils or other hazardous materials will be managed offshore through an Emergency Response Plan/Oil Spill Response Plan (ERP/OSRP) and onshore through a Spill Prevention, Control, and Countermeasure (SPCC) Plan. Sunrise Wind will require all construction and O&M vessels to comply with applicable International Convention for the Prevention of Pollution from Ships (IMO MARPOL), federal (USCG and EPA), and state regulations and standards for the management, treatment, discharge, and disposal of onboard solid and liquid wastes and the prevention and control of spills and discharges. Where HDD is utilized, an Inadvertent Return Plan will be prepared and implemented to minimize the potential risks associated with release of drilling fluids. Onshore construction activities will be conducted in compliance with the New York State Pollutant Discharge Elimination System (SPDES) General Permit for Stormwater Discharges associated with construction activities, and an approved SWPPP. An SWPPP, including erosion and sedimentation control BMPs and revegetation measures, will be implemented to minimize potential water quality impacts from construction and O&M of the Onshore Facilities.
Air Quality	<ul style="list-style-type: none"> Air Emissions 	<ul style="list-style-type: none"> Diesel generators on WTGs and the OCS-DC will only burn low sulfur diesel in the engines. Diesel generators on WTGs will only be used temporarily during commissioning or in an emergency power outage. Vessels meeting the definition of an OCS source and providing construction or maintenance services for the SRWF and SRWEC will use low sulfur fuel, Marine Distillate, or Marine Residual fuels when operating any diesel-fired emission unit, as specified by applicable regulations or OCS Permit conditions. Vessel engines will meet the applicable United States Environmental Protection Agency (EPA) air emission standards, as specified in the OCS Permit, to satisfy Best Available Control Technology (BACT) or Lowest Achievable Emission Rate (LAER). Onshore Facilities equipment and fuel suppliers will provide equipment and fuels that comply with the applicable EPA or equivalent emission standards. Potential fugitive emissions of particulate matter from onshore construction activities will be minimized by implementing dust control measures. Gas-insulated switchgears are manufactured to be completely sealed and would likely result in little or no SF6 emissions. Switchgears containing SF6 on the WTG, OCS-DC, and OnCS-DC will be equipped with integral low-pressure detectors to detect SF6 gas leakages should they occur. Sunrise Wind will obtain emission reduction credits to offset emissions from construction and O&M activities, if required as a condition of the OCS Permit.

CONSTRUCTION AND OPERATIONS PLAN

Site Characterization and Assessment of Impacts – Summary of Potential Impacts and Environmental Protection Measures

Resource	IPF Associated with Project	Environmental Protection Measures
Coastal and Terrestrial Habitat	<ul style="list-style-type: none"> • Seafloor and Land Disturbance • Sediment Suspension and Deposition • Discharges and Releases • Trash and Debris: Potential Impact • Traffic 	<ul style="list-style-type: none"> • The SRWEC Landfall will be installed via horizontal directional drilling (HDD) to avoid impacts to the nearshore zones and coastal resources. The Onshore Transmission Cable will also be installed via HDD under the Intracoastal Waterway (ICW) to avoid impacts to coastal resources; HDD and trenchless methods will also be used elsewhere onshore, where appropriate, to minimize impacts to resource areas. Onshore Facilities are primarily sited within previously disturbed and developed areas (e.g., roadways, ROWs, developed industrial/commercial areas) to the extent feasible, to minimize impacts to undisturbed coastal and terrestrial habitat. • An SWPPP, including erosion and sedimentation control BMPs and revegetation measures, will be implemented to minimize potential water quality impacts from construction and O&M of the Onshore Facilities. • Accidental spill or release of oils or other hazardous materials will be managed offshore through an ERP/OSRP and onshore through an SPCC Plan. • Where HDD is utilized, an Inadvertent Return Plan will be prepared and implemented to minimize the potential risks associated with the release of drilling fluids. • Time-of-year restrictions for certain work activities (e.g., HDD conduit stringing and tree removal) will be employed to the extent feasible to avoid or minimize direct impacts to terrestrial habitat and RTE species during construction of the Landfall and Onshore Facilities. If work is anticipated to occur outside of these time-of-year restriction periods, Sunrise Wind will work with state and federal agencies to develop construction monitoring and impact minimization plans or mitigation plans, as appropriate. • Where appropriate, temporary erosion controls such as swales and erosion control socks will be installed and will be maintained until the site is restored and stabilized. • An Invasive Species Management Plan (ISMP) will be implemented to manage the spread of invasive plant species that could negatively affect native plants and coastal habitat. • Sunrise Wind will comply with applicable international (IMO MARPOL), federal (USCG), and state regulations and standards for treatment and disposal of solid and liquid wastes generated during all phases of the Project.
Benthic and Shellfish Resources	<ul style="list-style-type: none"> • Seafloor and Land Disturbance • Sediment Suspension and Deposition • Noise • Discharges and Releases • Trash and Debris 	<ul style="list-style-type: none"> • Sunrise Wind is committed to collaborative science with the commercial and recreational fishing industries prior to, during, and following construction. Fisheries monitoring studies are being planned to assess the impacts associated with the Project on economically and ecologically important fisheries resources within the SRWF and along the SRWEC. These studies will be conducted in collaboration with the local fishing industry and will build upon monitoring efforts being conducted by affiliates of Sunrise Wind at other wind farms in the region. • The SRWF and SRWEC will be sited to avoid and minimize impacts to sensitive habitats (e.g., hard bottom habitats) to the extent practicable. • To the extent feasible, the SRWEC and IAC will typically target a burial depth of 3 to 7 ft (1 to 2 m). The target burial depth will be determined based on an assessment of seabed conditions, seabed mobility, the risk of interaction with external hazards such as fishing gear and vessel anchors, and a site-specific Cable Burial Risk Assessment. The SRWEC Landfall will be installed via horizontal directional drilling (HDD) to avoid impacts to the nearshore zones and benthic resources. The Onshore Transmission Cable will also be installed via HDD under the Intracoastal Waterway (ICW) to avoid impacts to benthic resources; HDD and trenchless methods will also be used elsewhere onshore, where appropriate, to minimize impacts to resource areas. • To the extent feasible, installation of the IAC and SRWEC will be buried using equipment such as mechanical plow, jet plow, and/or mechanical cutter. These equipment options would result in less habitat modification than dredging options. The feasibility of cable burial equipment will be determined based on an assessment of seabed conditions and the Cable Burial Risk Assessment. • DP vessels will be used for installation of the IAC and SRWEC to the extent practicable. DP vessels minimize seafloor impacts, as compared to use of a vessel relying on multiple anchors. • A plan for vessels will be developed prior to construction to identify no-anchorage areas to avoid documented sensitive resources. • Sunrise Wind will require all construction and O&M vessels to comply with applicable International Convention for the Prevention of Pollution from Ships (IMO MARPOL), federal (USCG and EPA), and state regulations and standards for the management, treatment, discharge, and disposal of onboard solid and liquid wastes and the prevention and control of spills and discharges. Accidental spill or release of oils or other hazardous materials will be managed offshore through an ERP/OSRP and onshore through an SPCC Plan.
Finfish and Essential Fish Habitat (EFH)	<ul style="list-style-type: none"> • Seafloor and Land Disturbance • Sediment Suspension and Deposition • Noise • Electric and Magnetic Fields • Discharges and Releases • Trash and Debris • Traffic • Lighting and Marking 	<ul style="list-style-type: none"> • Sunrise Wind is committed to collaborative science with the commercial and recreational fishing industries prior to, during, and following construction. Fisheries monitoring studies are being planned to assess the impacts associated with the Project on economically and ecologically important fisheries resources within the SRWF and along the SRWEC. These studies will be conducted in collaboration with the local fishing industry and will build upon monitoring efforts being conducted by affiliates of Sunrise Wind at other wind farms in the region. • To the extent feasible, installation of the IAC and SRWEC will be buried using equipment such as mechanical plow, jet plow, and/or mechanical cutter. These equipment options would result in less habitat modification than dredging options. The feasibility of cable burial equipment will be determined based on an assessment of seabed conditions and the Cable Burial Risk Assessment. • To the extent feasible, the SRWEC and IAC will typically target a burial depth of 3 to 7 ft (1 to 2 m). The target burial depth will be determined based on an assessment of seabed conditions, seabed mobility, the risk of interaction with external hazards such as fishing gear and vessel anchors, and a site-specific Cable Burial Risk Assessment. The SRWEC Landfall will be installed via horizontal directional drilling (HDD) to avoid impacts to the nearshore zones and finfish resources. The Onshore Transmission Cable will also be installed via HDD under the Intracoastal Waterway (ICW) to avoid impacts to coastal resources; HDD and trenchless methods will also be used elsewhere onshore, where appropriate, to minimize impacts to resource areas. • Construction and operational lighting will be limited to the minimum necessary to ensure safety and compliance with applicable regulations. Limiting lighting to that which is required for safety and compliance with applicable regulations is expected to minimize impacts on EFH. • DP vessels will be used for installation of the IAC and SRWEC to the extent practicable. Use of DP vessels will minimize impacts to the seabed, compared to use of a vessel relying on multiple anchors. A plan for vessels will be developed prior to construction to identify no-anchorage areas to avoid documented sensitive resources. • Time-of-year in-water restrictions will be employed to the extent feasible to avoid or minimize direct impacts to species of concern, such as Atlantic sturgeon or winter flounder, during construction. If work is anticipated to occur outside of these time-of-year restriction periods, Sunrise Wind will work with state and federal agencies to develop construction monitoring and impact minimization plans or mitigation plans, as appropriate. • Accidental spill or release of oils or other hazardous materials will be managed offshore through an ERP/OSRP and onshore through an SPCC Plan. • Sunrise Wind will require all construction and O&M vessels to comply with applicable International Convention for the Prevention of Pollution from Ships (IMO MARPOL), federal (USCG and EPA), and state regulations and standards for the management, treatment, discharge, and disposal of onboard solid and liquid wastes and the prevention and control of spills and discharges.

CONSTRUCTION AND OPERATIONS PLAN

Site Characterization and Assessment of Impacts – Summary of Potential Impacts and Environmental Protection Measures

Resource	IPF Associated with Project	Environmental Protection Measures
Marine Mammals	<ul style="list-style-type: none"> • Seafloor and Land Disturbance • Sediment Suspension and Deposition • Noise • Electric and Magnetic Fields • Discharges and Releases • Trash and Debris • Traffic • Air Emissions • Visible Infrastructure • Lighting and Marking 	<ul style="list-style-type: none"> • Sunrise Wind will comply with the current National Oceanic and Atmospheric Administration (NOAA) Fisheries speed restrictions at the time of Project activities. • Sunrise Wind will require operational automatic identification system (AIS) on all vessels associated with the construction, O&M, and decommissioning of the Project, pursuant to USCG and AIS carriage requirements. AIS will be used to monitor the number of vessels and traffic patterns for analysis and compliance with vessel speed requirements. • Sunrise Wind will adhere to vessel strike avoidance measures as required by BOEM and NOAA Fisheries. • To the extent feasible, the SRWEC and IAC will typically target a burial depth of 3 to 7 ft (1 to 2 m). The target burial depth will be determined based on an assessment of seabed conditions, seabed mobility, the risk of interaction with external hazards such as fishing gear and vessel anchors, and a site-specific Cable Burial Risk Assessment. • For all munitions and explosives of concern / unexploded ordnance (MEC/UXO) clearance methods, safety measures such as the use of guard vessels, enforcement of safety zones, and others will be identified in consultation with a MEC/UXO specialist and the appropriate agencies and implemented as appropriate. Residual risk management actions will be implemented, including developing an emergency response plan, conducting MEC/UXO-specific safety briefings, and retaining an on-call MEC/UXO consultant. • Plow cables/umbilicals will be under constant tension, and in this taut condition, are not expected to represent an entanglement risk. • Sunrise Wind will require all construction and O&M vessels to comply with applicable International Convention for the Prevention of Pollution from Ships (IMO MARPOL), federal (USCG and EPA), and state regulations and standards for the management, treatment, discharge, and disposal of onboard solid and liquid wastes and the prevention and control of spills and discharges. • Sunrise Wind will provide training for personnel onboard Project vessels, including PSO monitoring and reporting procedures, to emphasize individual responsibility for marine mammal awareness and protection. • All crew supporting the Project will undergo marine debris awareness training, and such training will include use of the data and educational resources available through the NOAA Fisheries Marine Debris Program. • Sunrise Wind will advise all construction and O&M vessels to comply with USCG and EPA regulations that require operators to develop waste management plans, post informational placards, manifest trash sent to shore, and use special precautions such as covering outside trash bins to prevent accidental loss of solid materials. • Sunrise Wind completed a comprehensive underwater acoustic assessment to include modeling in support of evaluation of potential impacts due to noise generated during construction of the Project. The assessment followed NOAA Fisheries' 2018 revised <i>Technical Guidance for Assessing the Effects of Anthropogenic Sound on Marine Mammal Hearing</i> (NOAA Construction and Operations Plan Fisheries 2018a). Potential zones of influence described in this assessment will be reflected in the proposed mitigation measures in the mitigation and monitoring plan. • Sunrise Wind will continue to support external initiatives to further mitigate marine traffic impacts and currently is a supporter of the Whale Alert system. • Sunrise Wind will participate in a developer co-funded initiative to support continuation of New England Aquarium Right Whale Aerial Surveys in 2020/21. • Additionally, the Project will implement the following mitigation measures, pursuant to ongoing dialogue with BOEM and NOAA Fisheries. Each of these methods and tools has been successfully applied by Orsted, Sunrise Wind, and/or its affiliates in support of geophysical surveys and/or the construction and operation of offshore wind projects across the globe. A protected species mitigation and monitoring plan will describe these measures and will be included within the Letter of Authorization (LOA): <ul style="list-style-type: none"> – Exclusion and monitoring zones – Ramp-up/soft-start procedures – Shutdown procedures (if technically feasible) – Qualified and NOAA Fisheries-approved protected species observers (PSOs) – Noise attenuation technologies – Passive Acoustic Monitoring systems (fixed and mobile) – Reduced visibility monitoring tools/technologies (e.g., night vision, infrared and/or thermal cameras) – Adaptive vessel speed reductions – Utilization of software to share visual and acoustic detection data between platforms in real time.

CONSTRUCTION AND OPERATIONS PLAN

Site Characterization and Assessment of Impacts – Summary of Potential Impacts and Environmental Protection Measures

Resource	IPF Associated with Project	Environmental Protection Measures
Sea Turtles	<ul style="list-style-type: none"> • Seafloor and Land Disturbance • Sediment Suspension and Deposition • Noise • Electric and Magnetic Fields • Discharges and Releases • Trash and Debris • Traffic • Visible Infrastructure • Lighting and Marking 	<ul style="list-style-type: none"> • Sunrise Wind will comply with the current NOAA Fisheries speed restrictions at the time of Project activities. These measures for marine mammals will aid in minimizing impacts to sea turtles as well. • Sunrise Wind will require operational AIS on all vessels associated with the construction, operation, and decommissioning of the Project, pursuant to USCG and AIS carriage requirements. AIS will be used to monitor the number of vessels and traffic patterns for analysis and compliance with vessel speed requirements. • Sunrise Wind will adhere to vessel strike avoidance measures as required by BOEM and NOAA Fisheries. • To the extent feasible, the SRWEC and IAC will typically target a burial depth of 3 to 7 ft (1 to 2 m). The target burial depth will be determined based on an assessment of seabed conditions, seabed mobility, the risk of interaction with external hazards such as fishing gear and vessel anchors, and a site-specific Cable Burial Risk Assessment. • For all MEC/UXO clearance methods, safety measures such as the use of guard vessels, enforcement of safety zones, and others will be identified in consultation with a MEC/UXO specialist and the appropriate agencies and implemented as appropriate. Residual risk management actions will be implemented, including developing an emergency response plan, conducting MEC/UXO-specific safety briefings, and retaining an on-call MEC/UXO consultant. • Plow cables/umbilicals will be under constant tension, and in this taut condition, are not expected to represent an entanglement risk. • Sunrise Wind will require all construction and O&M vessels to comply with applicable International Convention for the Prevention of Pollution from Ships (IMO MARPOL), federal (USCG and EPA), and state regulations and standards for the management, treatment, discharge, and disposal of onboard solid and liquid wastes and the prevention and control of spills and discharges. • Sunrise Wind will provide training for personnel onboard Project vessels, including PSO monitoring and reporting procedures, to emphasize individual responsibility for sea turtle awareness and protection. • All crew supporting the Project will undergo marine debris awareness training, and such training will include use of the data and educational resources available through the NOAA Fisheries Marine Debris Program. • Sunrise Wind will advise all construction and O&M vessels to comply with USCG and EPA regulations that require operators to develop waste management plans, post informational placards, manifest trash sent to shore, and use special precautions such as covering outside trash bins to prevent accidental loss of solid materials. • Sunrise Wind completed a comprehensive underwater acoustic assessment to include modeling in support of evaluation of potential impacts due to noise generated during construction of the Project. The assessment followed NOAA Fisheries' Greater Atlantic Regional Fisheries Office tool for assessing the potential effects to ESA-listed fish and sea turtles exposed to elevated levels of underwater sound from pile driving. Potential zones of influence described in this assessment will be reflected in the proposed mitigation measures in the mitigation and monitoring plan. • Additionally, the Project will implement the following mitigation measures, pursuant to ongoing dialogue with BOEM and NOAA Fisheries. Each of these methods and tools has been successfully applied by Orsted, Sunrise Wind, and/or its affiliates in support of geophysical surveys and/or the construction and operation of offshore wind projects across the globe. A protected species mitigation and monitoring plan will describe these measures and will be included within the LOA; these measures will also aid in minimizing impacts to sea turtles: <ul style="list-style-type: none"> – Exclusion and monitoring zones – Ramp-up/soft-start procedures – Shutdown procedures (if technically feasible) – Qualified and NOAA Fisheries-approved protected species observers (PSOs) – Noise attenuation technologies – Passive Acoustic Monitoring systems (fixed and mobile) – Reduced visibility monitoring tools/technologies (e.g., night vision, infrared and/or thermal cameras) – Adaptive vessel speed reductions – Utilization of software to share visual and acoustic detection data between platforms in real time.

CONSTRUCTION AND OPERATIONS PLAN

Site Characterization and Assessment of Impacts – Summary of Potential Impacts and Environmental Protection Measures

Resource	IPF Associated with Project	Environmental Protection Measures
Avian Species	<ul style="list-style-type: none"> • Seafloor and Land Disturbance • Sediment Suspension and Deposition • Noise • Discharges and Releases • Trash and Debris • Traffic • Visible Infrastructure • Lighting and Marking 	<ul style="list-style-type: none"> • Sunrise Wind is committed to an indicative layout scenario with WTGs and the OCS–DC sited in a uniform east-west/north-south grid with 1.15 by 1.15-mi (1 by 1-nm; 1.85 by 1.85-km) spacing that aligns with other proposed adjacent offshore wind projects in the RI-MA WEA and MA WEA. This wide spacing of WTGs may reduce risk of barrier effects and/or displacement, and may allow avian species to avoid individual WTGs and minimize risk of potential collision. The WTGs will have an air gap from MSL to minimum blade swept height of 98 to 180 ft (30 to 55 m); birds crossing the area within this height range would not be at risk of collision with spinning blades. • The distance of the SRWF offshore (greater than 15 miles ([13 nm, 24.1 km])) avoids coastal areas, which are known to concentrate birds, particularly shorebirds and sea ducks. • Sunrise Wind will take measures to reduce perching opportunities at operating turbines, if appropriate based on further consultations with state and federal agencies. • Sunrise Wind will document any dead (or injured) birds found incidentally on vessels and structures during construction, O&M, and decommissioning and provide an annual report to BOEM and USFWS. • Construction and operational lighting will be limited to the minimum necessary to ensure safety and compliance with applicable regulations. Limiting lighting to that which is required for safety and compliance with applicable regulations is expected to minimize impacts on avian species. • Sunrise Wind will use ADLS or related means (e.g., dimming or shielding) to limit visual impact, pursuant to approval by the FAA and BOEM, commercial and technical feasibility at the time of FDR/FIR approval, and dialogue with stakeholders. In addition to limiting visual impact, reducing lighting will also reduce the potential for impacts to avian species. • Accidental spill or release of oils or other hazardous materials will be managed offshore through an ERP/OSRP and onshore through an SPCC Plan. • Time-of-year restrictions for certain work activities such as HDD conduit stringing will be employed to the extent feasible to avoid or minimize direct impacts to RTE avian species during construction of the Landfall. Time-of-year restrictions for tree removal at the Onshore Facilities to avoid impacts to northern long-eared bats would also benefit breeding birds. If work is anticipated to occur outside of these time-of-year restriction periods, Sunrise Wind will work with state and federal agencies to develop construction monitoring and impact minimization plans or mitigation plans, as appropriate. • Onshore Facilities are primarily sited within previously disturbed and developed areas (e.g., roadways, ROWs, developed industrial/commercial areas) to the extent feasible, thereby minimizing impacts to undisturbed avian habitat. • An ISMP will be implemented to manage the spread of invasive plant species that could negatively impact native plants and avian habitat. • The Onshore Transmission Cable and Onshore Interconnection Cable will not include any overhead utility poles, thus minimizing potential impacts to birds associated with collision with overhead lines. • Sunrise Wind is developing an avian post-construction monitoring plan for the Project that will summarize the approach to monitoring; describe overarching monitoring goals and objectives; identify the key avian species, priority questions, and data gaps unique to the region and Project Area that will be addressed through monitoring; and describe methods and time frames for data collection, analysis, and reporting. Post-construction monitoring will assess impacts of the Project with the purpose of filling select information gaps and supporting validation of the Sunrise Wind Avian Risk Assessment. Focus may be placed on improving knowledge of ESA-listed species occurrence and movements offshore, avian collision risk, species/species-group displacement, or similar topics. Where practicable, monitoring conducted by Sunrise Wind will build on and align with post-construction monitoring conducted by the other Orsted/Eversource offshore wind projects in the Northeast region. Sunrise Wind will engage with federal and state agencies and environmental groups (eNGOs) to identify appropriate monitoring options and technologies, and to facilitate acceptance of the final plan.
Bat Species	<ul style="list-style-type: none"> • Seafloor and Land Disturbance • Noise • Traffic • Visible Infrastructure • Lighting and Marking 	<ul style="list-style-type: none"> • Sunrise Wind is committed to an indicative layout scenario with WTGs and the OCS–DC sited in a uniform east-west/north-south grid with 1.15 by 1.15-mi (1 by 1-nm; 1.85 by 1.85-km) spacing that aligns with other proposed adjacent offshore wind projects in the RI-MA WEA and MA WEA. This wide spacing of WTGs may reduce risk of barrier effects and/or displacement, and may allow bats to avoid individual WTGs and minimize risk of potential collision. The WTGs will have an air gap from MSL to minimum blade swept height of 98 to 180 ft (30 to 55 m); bats crossing the area within this height range would not be at risk of collision with spinning blades. • The distance of the SRWF offshore (greater than 15 miles [13 nm, 24.1 km])) avoids coastal and nearshore areas where bats typically occur. • Construction and operational lighting will be limited to the minimum necessary to ensure safety and compliance with applicable regulations. Limiting lighting to that which is required for safety and compliance with applicable regulations is expected to minimize impacts on bats. • Sunrise Wind will use ADLS or related means (e.g., dimming or shielding) to limit visual impact, pursuant to approval by the FAA and BOEM, commercial and technical feasibility at the time of FDR/FIR approval, and dialogue with stakeholders. In addition to limiting visual impact, reducing lighting will also reduce the potential for impacts to bats. • Onshore Facilities are primarily sited within previously disturbed and developed areas (e.g., roadways, ROWs, developed industrial/commercial areas) to the extent feasible, thereby minimizing impacts to undisturbed bat habitat. • An ISMP will be implemented to manage the spread of invasive plant species that could negatively impact native plants and bat habitat. • Sunrise Wind will document any dead (or injured) bats found incidentally on vessels and structures during construction, O&M, and decommissioning and provide an annual report to BOEM and USFWS. • Time-of-year restrictions for certain work activities such as tree removal will be employed to the extent feasible to avoid or minimize direct impacts to northern long-eared bats during construction of the Onshore Facilities. If work is anticipated to occur outside of this period, Sunrise Wind will work with state and federal agencies to develop construction monitoring and impact minimization plans or mitigation plans, as appropriate. • The Onshore Transmission Cable and Onshore Interconnection Cable will not include any overhead utility poles, thus minimizing potential impacts to bats associated with collision with overhead lines.

CONSTRUCTION AND OPERATIONS PLAN

Site Characterization and Assessment of Impacts – Summary of Potential Impacts and Environmental Protection Measures

Resource	IPF Associated with Project	Environmental Protection Measures
Visual Resources	<ul style="list-style-type: none"> Traffic Visible Infrastructure Lighting and Marking 	<ul style="list-style-type: none"> WTGs will have uniform design, height, and rotor diameter. The WTGs will be painted no lighter than Pure White (RAL 9010) and no darker than Light Grey (RAL 7035) as recommended by BOEM and the FAA. Turbines of this color white generally blend well with the sky at the horizon and eliminate the need for daytime warning lights or red paint marking of the blade tips. The WTGs and OCS–DC will be lit and marked in accordance with BOEM and USCG requirements for aviation and navigation obstruction lighting, respectively. The WTGs will be lit and marked in accordance with FAA Advisory Circular 70/7460-1L (2018), as recommended by BOEM's <i>Guidelines for Lighting and Marking of Structures Supporting Renewable Energy Development</i> (BOEM 2021). Sunrise Wind will use ADLS or related means (e.g., dimming or shielding) to limit visual impact, pursuant to approval by the FAA and BOEM, commercial and technical feasibility at the time of FDR/FIR approval, and dialogue with stakeholders. The construction of the Landfall and ICW HDD is expected to occur outside the summer tourist season, which is generally between Memorial Day and Labor Day. The construction schedule for the remaining Onshore Facilities will be designed to minimize impacts to the local communities to the extent feasible. The Onshore Transmission Cable and Onshore Interconnection Cable will not include any overhead utility poles, thus minimizing potential impacts to adjacent properties. The OnCS–DC is sited near an existing substation on a parcel zoned for commercial and industrial/utility use. Screening will be implemented at the OnCS–DC to the extent feasible, to reduce potential visibility and noise.
Marine Archaeological Resources	<ul style="list-style-type: none"> Seafloor and Land Disturbance Sediment Suspension and Deposition 	<ul style="list-style-type: none"> The SRWF and SRWEC will be sited to avoid or minimize impacts to potential marine archaeological resources (MARs), including shipwrecks and paleolandforms, to the extent practicable, with continued oversight by a Qualified Marine Archaeologist. Native American tribes were involved, and will continue to be involved, in marine survey protocol design, execution of the surveys, and interpretation of the results. A plan for vessels will be developed prior to construction to identify no-anchorage areas to avoid documented sensitive resources. Avoidance areas surrounding identified MARs will reduce the chances of accidental disturbance. The size of these areas will be determined individually based on characterization of the site and delineation of the site's horizontal and vertical boundaries. An Unanticipated Discovery Plan will be implemented that will include stop-work and notification procedures to be followed if potentially significant MARs are encountered or inadvertently disturbed during construction.
Terrestrial Archaeological Resources	<ul style="list-style-type: none"> Seafloor and Land Disturbance 	<ul style="list-style-type: none"> Onshore Facilities are primarily sited within previously disturbed and developed areas (e.g., roadways, ROWs, developed industrial/commercial areas) to the extent feasible, to minimize impacts to potential archaeological resources. Onshore Facilities have been sited, using guidance from cultural resources surveys, to avoid or minimize impacts to potential terrestrial archeological resources. Native American tribes were involved, and will continue to be involved, in terrestrial survey protocol design, execution of the surveys, and interpretation of the results. An Unanticipated Discovery Plan will be implemented that will include stop-work and notification procedures to be followed if a cultural resource is encountered during installation.
Above-Ground Historic Properties	<ul style="list-style-type: none"> Noise Traffic Visible Infrastructure Lighting and Marking 	<ul style="list-style-type: none"> WTGs will have uniform design, height, and rotor diameter. The WTGs will be painted no lighter than Pure White (RAL 9010) and no darker than Light Grey (RAL 7035) as recommended by BOEM and the FAA. Turbines of this color white generally blend well with the sky at the horizon and eliminate the need for daytime warning lights or red paint marking of the blade tips. The WTGs and OCS–DC will be lit and marked in accordance with BOEM and USCG requirements for aviation and navigation obstruction lighting, respectively. Sunrise Wind will use ADLS or related means (e.g., dimming or shielding) to limit visual impact, pursuant to approval by the FAA and BOEM, commercial and technical feasibility at the time of FDR/FIR approval, and dialogue with stakeholders. The Onshore Transmission Cable and Onshore Interconnection Cable will not include any overhead utility poles, thus minimizing potential impacts to adjacent properties. The OnCS–DC is sited near an existing substation on a parcel zoned for commercial and industrial/utility use. Screening will be implemented at the OnCS–DC to the extent feasible, to reduce potential visibility and noise.
Employment, Economics, and Demographics	<ul style="list-style-type: none"> Visible Infrastructure Traffic 	<ul style="list-style-type: none"> Where feasible, local workers will be hired to meet labor needs for Project construction, O&M, and decommissioning. The construction of the Landfall and ICW HDD is expected to occur outside the summer tourist season, which is generally between Memorial Day and Labor Day. The construction schedule for the remaining Onshore Facilities will be designed to minimize impacts to the local communities to the extent feasible. The Onshore Transmission Cable and Onshore Interconnection Cable will not include any overhead utility poles, thus minimizing potential impacts to adjacent properties. Screening will be implemented at the OnCS–DC to the extent feasible, to reduce potential visibility and noise. Sunrise Wind will coordinate with local authorities and develop a Maintenance and Protection of Traffic (MPT) plan as part of the Project's Environmental Management and Construction Plan (EM&CP) to minimize potential traffic impacts during construction. Sunrise Wind will use ADLS or related means (e.g., dimming or shielding) to limit visual impact, pursuant to approval by the FAA and BOEM, commercial and technical feasibility at the time of FDR/FIR approval, and dialogue with stakeholders.

CONSTRUCTION AND OPERATIONS PLAN

Site Characterization and Assessment of Impacts – Summary of Potential Impacts and Environmental Protection Measures

Resource	IPF Associated with Project	Environmental Protection Measures
Public Services	<ul style="list-style-type: none"> Traffic 	<ul style="list-style-type: none"> The construction of the Landfall and ICW HDD is expected to occur outside the summer tourist season, which is generally between Memorial Day and Labor Day. The construction schedule for the remaining Onshore Facilities will be designed to minimize impacts to the local communities to the extent feasible. Sunrise Wind will coordinate with local authorities and develop an MPT plan as part of the Project's EM&CP to minimize potential traffic impacts during construction. A comprehensive communication plan will be implemented during offshore construction to inform all mariners, including commercial and recreational fishing vessels, and recreational boaters, of construction activities and Project-related vessel movements. Communication will be facilitated through a Project website, public notices to mariners and vessel float plans, and a Fisheries Liaison. Sunrise Wind will submit information to the USCG to issue Local Notice to Mariners during offshore installation activities.
Recreation & Tourism	<ul style="list-style-type: none"> Traffic Visible Infrastructure Lighting and Marking 	<ul style="list-style-type: none"> The construction of the Landfall and ICW HDD is expected to occur outside the summer tourist season, which is generally between Memorial Day and Labor Day. The construction schedule for the remaining Onshore Facilities will be designed to minimize impacts to the local communities to the extent feasible. Sunrise Wind will coordinate with local authorities and develop an MPT plan as part of the Project's EM&CP to minimize potential traffic impacts during construction. A comprehensive communication plan will be implemented during offshore construction to inform all mariners, including commercial and recreational fishing vessels, and recreational boaters, of construction activities and Project-related vessel movements. Communication will be facilitated through a Project website, public notices to mariners and vessel float plans, and a Fisheries Liaison. Sunrise Wind will submit information to the USCG to issue Local Notice to Mariners during offshore installation activities. The communication plan will include outreach to stakeholders in the offshore recreational and tourism industry to minimize impacts to recreational events (e.g., sailboat races).
Commercial and Recreational Fishing	<ul style="list-style-type: none"> Seafloor and Land Disturbance Sediment Suspension and Deposition Noise Electric and Magnetic Fields Discharges and Releases Trash and Debris Traffic Visible Infrastructure Lighting and Marking 	<ul style="list-style-type: none"> Sunrise Wind is committed to an indicative layout scenario with WTGs and the OCS-DC sited in a uniform east-west/north-south grid with 1.15 by 1.15-mi (1 by 1-nm; 1.85 by 1.85-km) spacing that aligns with other proposed adjacent offshore wind projects in the RI-MA WEA and MA WEA. This layout has been confirmed through expert analysis and the USCG (USCG 2020) to allow for safe navigation without the need for additional designated transit lanes. This layout will also provide a uniform, wide spacing among structures to facilitate search and rescue operations and is consistent with study recommendations in the USCG Massachusetts and Rhode Island Port Access Route Study (USCG 2020). Sunrise Wind is committed to collaborative science with the commercial and recreational fishing industries prior to, during, and following construction. Fisheries monitoring studies are being planned to assess the impacts associated with the Project on economically and ecologically important fisheries resources within the SRWF and along the SRWEC. These studies will be conducted in collaboration with the local fishing industry and will build upon monitoring efforts being conducted by affiliates of Sunrise Wind at other wind farms in the region. Sunrise Wind aims, where feasible, to mitigate and reduce potential impacts to fishing activities, as outlined in the <i>Fisheries Communication and Outreach Plan</i> (Appendix B), and the <i>Fisheries Mitigation Plan for Sunrise Wind</i> (Sunrise Wind 2019), which is available on the NYSERDA website and will be updated throughout Project development. The locations of the SRWF, SRWEC and IAC and associated cable protections will be provided to NOAA's Office of Coast Survey after installation is completed so that they may be marked on nautical charts. To the extent feasible, installation of the SRWEC and IAC will occur using methods such as mechanical plow, jet plow, or mechanical cutter. To the extent feasible, the SRWEC and IAC will typically target a burial depth of 3 to 7 ft (1 to 2 m). The target burial depth will be determined based on an assessment of seabed conditions, seabed mobility, the risk of interaction with external hazards such as fishing gear and vessel anchors, and a site-specific Cable Burial Risk Assessment. The cables include various protective armoring and sheathing to protect the cable from external damage and keep it watertight. Cable protection measures will be employed where cable burial depth is not adequate. As appropriate and feasible, BMPs will be implemented to minimize impacts on fisheries, as described in BOEM's <i>Guidelines for Providing Information on Fisheries for Renewable Energy Development on the Atlantic Outer Continental Shelf Pursuant to 30 CFR Part 585</i> (BOEM 2019). The WTGs will be lit and marked in accordance with FAA Advisory Circular 70/7460-1L (2018), as recommended by BOEM's <i>Guidelines for Lighting and Marking of Structures Supporting Renewable Energy Development</i> (BOEM 2021). The WTGs and OCS-DC will be lit and marked in accordance with BOEM and USCG requirements for aviation and navigation obstruction lighting, respectively. Navigation lights, markings, sound signals, and other aids to navigation (ATON) (including AIS on select WTGs) will be installed and maintained as prescribed within the Private Aids to Navigation (PATON) permit issued by the USCG for each WTG and the OCS-DC. Sunrise Wind will require all construction and O&M vessels to comply with applicable International Convention for the Prevention of Pollution from Ships (IMO MARPOL), federal (USCG and EPA), and state regulations and standards for the management, treatment, discharge, and disposal of onboard solid and liquid wastes and the prevention and control of spills and discharges. Accidental spill or release of oils or other hazardous materials will be managed offshore through an ERP/OSRP and onshore through an SPCC Plan. Project construction, O&M, and decommissioning activities will be coordinated with appropriate contacts at USCG and DoD command headquarters. A comprehensive communication plan will be implemented during offshore construction to inform all mariners, including commercial and recreational fishing vessels, and recreational boaters, of construction activities and Project-related vessel movements. Communication will be facilitated through a Project website, public notices to mariners and vessel float plans, and a Fisheries Liaison. Sunrise Wind will submit information to the USCG to issue Local Notice to Mariners during offshore installation activities.

CONSTRUCTION AND OPERATIONS PLAN

Site Characterization and Assessment of Impacts – Summary of Potential Impacts and Environmental Protection Measures

Resource	IPF Associated with Project	Environmental Protection Measures
Other Marine Uses and Coastal Land Use	<ul style="list-style-type: none"> • Seafloor and Land Disturbance • Traffic • Visible Infrastructure • Lighting and Marking 	<ul style="list-style-type: none"> • Sunrise Wind will minimize conflicts with other marine uses, through development and implementation of a MEC/UXO risk assessment strategy, coordination with USCG and DoD (including Public Notices to Mariners), coordination with existing telecommunications cable owners, and coordination with BOEM and potential future lease owners if a lease area is identified at a future time in the area where the SRWEC is sited. • Sunrise Wind will consult with the USCG, US Navy, Naval Undersea Warfare Center (NUWC), the Northeast Marine Pilots Association, and regional ferry service operators to avoid or reduce use conflicts. • Sunrise Wind has implemented, or will implement, a number of measures to minimize adverse effects on existing cables, such as dropping four WTG positions; minimizing the number of IAC and SRWEC crossings, and crossing perpendicular where feasible; designing the Landfall HDD to avoid existing cables; coordinating with telecommunications cable owners to develop cable protection design, crossing, and proximity agreements; and following International Cable Protection Committee (ICPC) recommendations during construction and O&M. • Navigation lights, markings, sound signals, and other ATON, including AIS on select WTGs, will be installed and maintained as prescribed within the PATON permit issued by the USGC for each WTG and the OCS-DC. • The locations of the SRWF, SRWEC, IAC, and associated cable protections will be provided to NOAA's Office of Coast Survey after installation is completed so that they may be marked on nautical charts. • Onshore Facilities are primarily sited within previously disturbed and developed areas (e.g., roadways, ROWs, developed industrial/commercial areas) to the extent feasible, to minimize impacts to undisturbed coastal land uses. • The construction of the Landfall and ICW HDD is expected to occur outside the summer tourist season, which is generally between Memorial Day and Labor Day. The construction schedule for the remaining Onshore Facilities will be designed to minimize impacts to the local communities to the extent feasible. • Sunrise Wind will coordinate with local authorities and develop an MPT plan as part of the Project's EM&CP to minimize potential traffic impacts during construction.
Environmental Justice	<ul style="list-style-type: none"> • Seafloor and Land Disturbance • Noise • Traffic • Visible Infrastructure • Lighting and Marking 	<ul style="list-style-type: none"> • The use of wind to generate electricity will have a beneficial impact on air emissions in Suffolk County, as it reduces the need for electricity generation from traditional fossil fuel power plants on Long Island that produce greenhouse gas emissions. • Where feasible, local workers will be hired to meet labor needs for Project construction, O&M, and decommissioning. • The construction of the Landfall and ICW HDD is expected to occur outside the summer tourist season, which is generally between Memorial Day and Labor Day. The construction schedule for the remaining Onshore Facilities will be designed to minimize impacts to the local communities to the extent feasible. • Sunrise Wind will coordinate with local authorities and develop an MPT plan as part of the Project's EM&CP to minimize potential traffic impacts during construction. • Onshore activities within potential Environmental Justice areas are limited to work within roadways/ROWs such that any potential adverse effects from construction/noise would be short-term and temporary. • WTGs will be aligned and spaced consistently with other offshore wind facilities in the RI/MA WEA, reducing the potential for visual clutter. • WTGs will be painted to minimize visual contrast under common and prevailing atmospheric conditions. • Sunrise Wind is committed to avoiding impacts to submerged cultural resources wherever feasible and practicable and will continue to assess means of minimizing physical impacts to resources that cannot be avoided. <p>Sunrise Wind will continue to engage with Native American communities to identify other measures that feasibly and appropriately protect culturally sensitive marine species and respectfully incorporate traditional knowledge and practices in such measures.</p>

CONSTRUCTION AND OPERATIONS PLAN

Site Characterization and Assessment of Impacts – Summary of Potential Impacts and Environmental Protection Measures

Resource	IPF Associated with Project	Environmental Protection Measures
Marine Transportation and Navigation	<ul style="list-style-type: none"> Traffic Visible Infrastructure Lighting and Marking 	<ul style="list-style-type: none"> Sunrise Wind is committed to an indicative layout scenario with WTGs and the OCS-DC sited in a uniform east-west/north-south grid with 1.15 by 1.15-mi (1 by 1-nm; 1.85 by 1.85-km) spacing that aligns with other proposed adjacent offshore wind projects in the RI-MA WEA and MA WEA. This layout has been confirmed through expert analysis and the USCG (USCG 2020) to allow for safe navigation without the need for additional designated transit lanes. This layout will also provide a uniform, wide spacing among structures to facilitate search and rescue operations and is consistent with study recommendations in the USCG Massachusetts and Rhode Island Port Access Route Study (USCG 2020). Navigation lights, markings, sound signals, and other ATON (including AIS on select WTGs) will be installed and maintained as prescribed within the PATON permit issued by the USGC for each WTG and the OCS-DC. A notional lighting plan is included within Appendix X based on existing USCG regulations and policy and standards promulgated by the International Association of Marine Aids to Navigation and Lighthouse Authorities in Recommendation O-139, The Marking of Man-Made Offshore Structures (IALA 2013). The USCG has endorsed those standards. The WTGs and the OCS-DC will be lit and marked in accordance with BOEM and USCG requirements for aviation and navigation obstruction lighting, respectively. Sunrise Wind will use ADLS or related means (e.g., dimming or shielding) to limit visual impact, pursuant to approval by the FAA and BOEM, commercial and technical feasibility at the time of FDR/FIR approval, and dialogue with stakeholders. The WTGs will be lit and marked in accordance with FAA Advisory Circular 70/7460-1L (2018), as recommended by BOEM's <i>Guidelines for Lighting and Marking of Structures Supporting Renewable Energy Development</i> (BOEM 2021). Sunrise Wind will request, and it is expected that the USCG will establish, temporary safety zones around all marine construction activities. To reduce the likelihood of an allision or collision during construction, Project safety vessel(s) will be on scene to advise mariners of construction activity. Mariner Radio-Activated Sound Signals (MRASS) are VHF-based and are expected to be deployed in the SRWF, similar to the deployment at Block Island Wind Farm. To the extent feasible, the SRWEC and IAC will typically target a burial depth of 3 to 7 ft (1 to 2 m). The target burial depth will be determined based on an assessment of seabed conditions, seabed mobility, the risk of interaction with external hazards such as fishing gear and vessel anchors, and a site-specific Cable Burial Risk Assessment. The cables include various protective armoring and sheathing to protect the cable from external damage and keep it watertight. Cable protection measures will be employed where cable burial depth is not adequate. Vessel operators are expected to follow the International Regulations for Preventing Collisions at Sea 1972 (COLREGs) Rule 5 that states "at all times maintain a proper lookout by sight and hearing as well as by all available means appropriate in the prevailing circumstances and conditions so as to make a full appraisal of the situation and risk of collision." Sunrise Wind will require operational AIS on all vessels associated with construction, O&M, and decommissioning of the Project, pursuant to USCG and AIS carriage requirements. AIS will be used to monitor the number of vessels and traffic patterns for analysis and compliance with vessel speed requirements. The WTGs and the OCS-DC will have a marked air gap to aid in the avoidance of an allision incident. Emergency procedures will be developed and reviewed with relevant agencies, including the USCG, to ensure that response plans are adequate and properly resourced. A Project construction guideline will define a window related to wind, sea state, and other constraints under which construction activities will start/continue or will stop/be discontinued. Conditions and forecasts will be monitored to enable proactive planning and early warning of future unsafe conditions. A 24-hr operational monitoring center is planned to verify safe conditions are being maintained and will have the ability to remotely operate and shut down WTGs if required. During construction and O&M, notices to mariners will be published on, and broadcasted through, regular radio communications, online information will be available for mariners, and notices to mariners from the USCG will occur. Frequent updates on offshore activities to fishing operators will be provided via online updates, twice-daily updates on VHF channels, and through Fisheries Liaisons and local fisheries representatives based in regional ports. Information on the exact locations of newly installed Project components, including structures, cable, and cable protection, will be provided to NOAA to include on navigation charts to reduce any potential impact to marine navigation. The WTGs themselves may also serve as an information navigation aid for mariners, particularly at night because they will be lit and marked. A comprehensive communication plan will be implemented during offshore construction to inform all mariners, including commercial and recreational fishing vessels, and recreational boaters, of construction activities and Project-related vessel movements. Communication will be facilitated through a Project website, public notices to mariners and vessel float plans, and a Fisheries Liaison. Sunrise Wind will submit information to the USCG to issue Local Notice to Mariners during offshore installation activities.
Land Transportation and Navigation	<ul style="list-style-type: none"> Traffic 	<ul style="list-style-type: none"> To minimize impacts to local traffic, several trenchless crossings are planned along the route for the Onshore Transmission Cable, including at the LIRR. The construction of the Landfall and ICW HDD is expected to occur outside the summer tourist season, which is generally between Memorial Day and Labor Day. The construction schedule for the remaining Onshore Facilities will be designed to minimize impacts to the local communities to the extent feasible. All construction-related impacts to roadways and parking lots will be restored to pre-construction conditions in accordance with <i>NYS DOT Standard Specifications for Construction and Materials</i> and in coordination with local entities. Locations used for HDD work areas and temporary laydown yards will be restored to pre-existing conditions in accordance with landowner requests and permit requirements. Sunrise Wind will coordinate with local authorities and develop an MPT plan as part of the Project's EM&CP to minimize potential traffic impacts during construction. To allow for traffic to move safely, traffic control measures, such as signage and traffic flaggers, will be used wherever necessary. Traffic control measures to address traffic flow in and around construction areas will be developed as part of the MPT plans. Proper traffic control measures will be utilized to ensure the movement of traffic and to mitigate impacts on bus route schedules. Access to bus stops will also be maintained or temporarily relocated during construction, thereby minimizing impacts to bus stops and bus stop access. Because the Onshore Transmission Cable and Onshore Interconnection Cable will be installed entirely underground, it is not anticipated that operation of the Project will have an impact on local traffic during O&M. The Onshore Transmission Cable and Onshore Interconnection Cable will require very little maintenance, if any.

CONSTRUCTION AND OPERATIONS PLAN

Site Characterization and Assessment of Impacts – Summary of Potential Impacts and Environmental Protection Measures

Resource	IPF Associated with Project	Environmental Protection Measures
Air Transportation and Navigation	<ul style="list-style-type: none"> Visible Infrastructure Lighting and Marking 	<ul style="list-style-type: none"> Sunrise Wind is committed to an indicative layout scenario with WTGs and the OCS-DC sited in a uniform east-west/north-south grid with 1.15 by 1.15-mi (1 by 1-nm; 1.85 by 1.85-km) spacing that aligns with other proposed adjacent offshore wind projects in the RI-MA WEA and MA WEA. This layout has been confirmed through expert analysis and the USCG (USCG 2020) to allow for safe navigation without the need for additional designated transit lanes. This layout will also provide a uniform, wide spacing among structures to facilitate search and rescue operations and is consistent with study recommendations in the USCG Massachusetts and Rhode Island Port Access Route Study (USCG 2020). The WTGs and the OCS-DC will be lit and marked in accordance with BOEM and USCG requirements for aviation and navigation obstruction lighting, respectively. The WTGs will be lit and marked in accordance with FAA Advisory Circular 70/7460-1L (2018), as recommended by BOEM's <i>Guidelines for Lighting and Marking of Structures Supporting Renewable Energy Development</i> (BOEM 2021). Sunrise Wind will use ADLS or related means (e.g., dimming or shielding) to limit visual impact, pursuant to approval by the FAA and BOEM, commercial and technical feasibility at the time of FDR/FIR approval, and dialogue with stakeholders. The Onshore Transmission Cable and Onshore Interconnection Cable will not include any overhead utility poles.

CONSTRUCTION AND OPERATIONS PLAN

References – Section 1 – Introduction

SECTION 5 – REFERENCES

5.1 Section 1 – Introduction

- Bureau of Ocean Energy Management (BOEM). 2017. Phased Approaches to Offshore Wind Developments and Use of the Project Design Envelope, Final Technical Report. U.S. Department of the Interior, Bureau of Ocean Energy Management Office of Renewable Energy Programs. OCS Study BOEM 2017-057.
- BOEM. 2018. Draft Guidance Regarding the Use of a Project Design Envelope in a Construction and Operations Plan. U.S. Department of the Interior, Bureau of Ocean Energy Management Office of Renewable Energy Programs. January 12, 2018.
- Connecticut Department of Environmental Energy and Environmental Protection. 2015. 2014 Integrated Resources Plan for Connecticut. Available online: https://www.ct.gov/deep/lib/deep/energy/irp/2014_irp_final.pdf. Accessed February 28, 2019.
- Connecticut Department of Environmental Energy and Environmental Protection. 2018. Comprehensive Energy Strategy for Connecticut. Available online: https://www.ct.gov/deep/lib/deep/energy/ces/2018_comprehensive_energy_strategy.pdf. Accessed February 28, 2019.
- Department for Energy and Climate Change (DECC). 2011. National Policy Statement for Renewable Energy Infrastructure (EN-3). Presented to Parliament pursuant to Section 5(9) of *The Planning Act 2008*. July 2011. London: The Stationery Office. Available online: http://www.nemo-link.com/pdf/cpo/The_Overarching_National_Policy_Statement_for_Energy.pdf. Accessed November 19, 2017.
- Federal Aviation Administration. (FAA). 2018. Advisory Circular No.70/7460-1L. Obstruction Marking and Lighting. Available online: https://www.faa.gov/documentLibrary/media/Advisory_Circular/AC_70_7460-1L_-_Obstruction_Marking_and_Lighting_-_Change_2.pdf. Accessed October 2018.
- ISO-NE. 2018. 2018 Regional Electricity Outlook. Available online: https://www.iso-ne.com/static-assets/documents/2018/02/2018_reo.pdf. Accessed December 6, 2018.
- Massachusetts Executive Office of Energy and Environmental Affairs. 2015. Clean Energy and Climate Plan for 2020; 2015 Update. Available online: <https://www.mass.gov/files/documents/2017/12/06/Clean%20Energy%20and%20Climate%20Plan%20for%202020.pdf>. Accessed February 28, 2019.
- Ocean News. 2019. "New York Governor Aims to Quadruple Offshore Wind, But Prohibit Offshore Drilling." Published January 16, 2019. Available online: <https://www.oceannews.com/news/energy/new-york-governor-aims-to-quadruple-offshore-wind-but-prohibit-offshore-drilling>. Accessed January 21, 2019.

CONSTRUCTION AND OPERATIONS PLAN

References – Section 2 – Project Siting and Design Development

Rhode Island Office of Energy Resources. 2018. 2018 Annual Report. Available online: <http://www.energy.ri.gov/documents/Annual%20Reports/2018%20OER%20Annual%20Report.pdf>. Accessed February 28, 2019.

5.2 Section 2 – Project Siting and Design Development

BOEM. 2016. Guidelines for Information Requirements for a Renewable Energy Construction and Operations Plan (COP). United States Department of the Interior Office of Renewable Energy Programs, Bureau of Ocean Energy Management. Available online at: <https://www.boem.gov/COP-Guidelines/>. April 2016. Accessed June 27, 2018.

Massachusetts Office of Coastal Zone Management (MA CZM). 2015. Massachusetts Ocean Management Plan. Available online at: <https://www.mass.gov/service-details/massachusetts-ocean-management-plan>. Accessed October 2018.

Massachusetts Clean Energy Center (MassCEC). 2014. Offshore Wind Transmission Study Final Report. Retrieved from: <https://www.masscec.com/massachusetts-offshore-wind-transmission>. Accessed March 4, 2019.

5.3 Section 3 – Project Description

American Wind Energy Association (AWEA). 2012. AWEA Offshore Compliance Recommended Practices. Recommended Practices for Design, Deployment, and Operation of Offshore Wind Turbines in the United States. Available online at: <https://engage.awea.org/Shop/Product-Details?productid=%7bCDB874FE-7CE7-E811-80FC-000D3A01109B%7d>. Accessed June 2018.

Bureau of Ocean Energy Management (BOEM). 2021. Guidelines for Lighting and Marking of Structures Supporting Renewable Energy Development. Available online at: <https://www.boem.gov/2021-lighting-and-marking-guidelines>. Accessed May 25, 2021.

Deepwater Wind South Fork Wind, LLC. 2020. Construction and Operations Plan, South Fork Wind Farm. Submitted to Bureau of Ocean Energy Management. Submitted by Deepwater Wind South Fork, LLC. Submitted June 2018, Revised July 2020.

Federal Aviation Administration. (FAA). 2018. AC 70/7460-1L - Obstruction Marking and Lighting with Change 1 Document Information. https://www.faa.gov/documentLibrary/media/Advisory_Circular/AC_70_7460-1L_-_Obstruction_Marking_and_Lighting_-_Change_2.pdf. Accessed on April 20, 2018.

International Association of Marine Aids to Navigation and Lighthouse Authorities (IALA). 2013. IALA Recommendation O-139 – The Marking of Man-Made Offshore Structures. Edition 2, December 2013. Retrieved from <https://www.iala-aism.org/product/markings-of-man-made-offshore-structures-o-139/>. Accessed February 18, 2019.

USCG. 2015. Aids to Navigation Manual- Administration, COMDTINST M16500.7A. Retrieved from: https://media.defense.gov/2017/Mar/29/2001724016/-1/-1/0/CIM_16500_7A.PDF. Accessed February 15, 2019.

CONSTRUCTION AND OPERATIONS PLAN

References – Section 4 – Site Characterization and Assessment of Impacts

5.4 Section 4 – Site Characterization and Assessment of Impacts

5.4.1 Characterization and Assessment Approach

Bureau of Ocean Energy Management (BOEM). 2020. Information Guidelines for a Renewable Energy Construction and Operations Plan (COP). Accessed July 2020.
<https://www.boem.gov/sites/default/files/documents/about-boem/COP%20Guidelines.pdf>

5.4.2 Impact Producing Factors

Bureau of Ocean Energy Management (BOEM). 2019. Field Observations During Wind Turbine Operations at the Block Island Wind Farm, Rhode Island. OCS Study BOEM 2019-028. Accessed August 2020. https://espis.boem.gov/final%20reports/BOEM_2019-028.pdf.

Bureau of Ocean Energy Management (BOEM). 2021. Guidelines for Lighting and Marking of Structures Supporting Renewable Energy Development. Available online at: <https://www.boem.gov/2021-lighting-and-marking-guidelines>. Accessed May 25, 2021.

Cheesman, S. 2016. Measurements of Operational Wind Turbine Noise in UK Waters. In: Popper A., Hawkins A. (eds) The Effects of Noise on Aquatic Life II. Advances in Experimental Medicine and Biology, vol 875. Springer, New York, NY.

Collett, A.G. and T.I. Mason. 2014. Monitoring and Assessment of Operational Subsea Noise of Gunfleet Sands 3. Subacoustech Report No. E419R0201 for Dong Energy.

Federal Aviation Administration (FAA). 2016. Advisory Circular, AC No. 150/5345-43H. Accessed July 2020. https://www.faa.gov/documentLibrary/media/Advisory_Circular/150-5345-43GH.pdf.

Federal Aviation Administration (FAA). 2018. Advisory Circular, AC No. 70/7460-IL Change 2. Accessed July 2020.
https://www.faa.gov/documentLibrary/media/Advisory_Circular/AC_70_7460-1L_-_Obstruction_Marking_and_Lighting_-_Change_2.pdf.

INSPIRE Environmental. 2016. Hard Bottom Baseline and Post-Construction Surveys, Year 0 Report for 2015 Baseline and 2016 Post-Construction Surveys to Characterize Potential Impacts and Response of Hard Bottom Habitats to Anchor Placement at the Block Island Wind Farm (BIWF). Prepared by INSPIRE Environmental, Middletown, RI for Deepwater Wind Block Island, LLC, Providence, RI. 98 pp.

Institute of Electrical and Electronics Engineers (IEEE). 2019. Standard Procedures for Measurement of Power Frequency Electric and Magnetic Fields from AC Power Lines (ANSI/IEEE Std. 644-2019). IEEE, New York.

International Commission on Non-ionizing Radiation Protection (ICNIRP). 2010. Guidelines for limiting exposure to time-varying electric and magnetic fields (1 Hz to 100 kHz). Health Phys. 99:818-836.

CONSTRUCTION AND OPERATIONS PLAN

References – Section 4 – Site Characterization and Assessment of Impacts

Lindeboom, H.J., H.J. Kouwenhoven, M.J.N. Bergman, S. Bouma, S. Brasseur, R. Daan, R.C. Fijn, D. de Haan, S. Dirksen, R. van Hal, R. Hille Ris Lambers, R. ter Hofstede, K.L. Krijgsveld, M. Leopold, and M. Scheidat. 2011. Short-term ecological effects of an offshore wind farm in the Dutch coastal zone; a compilation. *Environmental Research Letters*. 6:1-13.

Miller, J.H. and G.R. Potty. 2017. Measurements of underwater sound radiated from an offshore wind turbine. *The Journal of the Acoustical Society of America*. 142(4):2699.

Tougaard, J., O.D. Henriksen, and L.A. Miller. 2009. Underwater noise from three types of offshore wind turbines: Estimation of impact zones for harbor porpoises and harbor seals. *Journal of the Acoustical Society of America*. 125(6):8.

5.4.3 Physical Resources

5.4.3.1 Oceanographic and Meteorological Conditions

Broström, G. 2008. On the influence of large wind farms on the upper ocean circulation. *Journal of Marine Systems*. 74: 585 – 591.

<https://www.sciencedirect.com/science/article/pii/S0924796308001085>.

Bureau of Ocean Energy Management (BOEM). 2020. Hydrodynamic Modeling and Particle Tracking in the U.S. Mid-Atlantic Bight (NSL 19-04).

<https://www.boem.gov/sites/default/files/documents/environment/environmental-studies/NSL-19-04.pdf>.

Chassignet, E.P., H.E. Hurlburt, O.M. Smedstad, G.R. Halliwell, P.J. Hogan, A.J. Wallcraft, R. Baraille, and R. Bleck. 2007. The HYCOM (HYbrid Coordinate Ocean Model) data assimilative system. *Journal of Marine Systems*. V. 65 (1-4). 60-83 pp.

<https://www.sciencedirect.com/science/article/pii/S0924796306002855>.

Chen, C., R.C. Beardsley, J. Qi, and H. Lin, 2016. Use of Finite-Volume Modeling and the Northeast Coastal Ocean Forecast System in Offshore Wind Energy Resource Planning. Final Report to the U.S. Department of the Interior, Bureau of Ocean Energy Management, Office of Renewable Energy Programs. BOEM 2016-050. 131pp.

Det Norske Veritas and Germanischer Lloyd (DNV GL). 2018. South Farm Wind Farm Metocean Design Criteria Report.

Halliwell, G.R. 2004. Evaluation of vertical coordinate and vertical mixing algorithms in the HYbrid-Coordinate Ocean Model (HYCOM). *Ocean Modeling*. V. 7 (3-4). 285-322 pp.

<https://www.sciencedirect.com/science/article/pii/S1463500303000556>.

Merrill, J. 2010. Fog and icing Occurrence, and Air Quality Factors for the Rhode Island Ocean Special Area Management Plan 2010.

National Oceanic and Atmospheric Association (NOAA) National Centers for Environmental Information (NCEI). 2011. Climate Forecast System Reanalysis (CFSR).

<https://www.ncdc.noaa.gov/data-access/model-data/model-datasets/climate-forecast-system-version2-cfsv2>.

NOAA NCEI. 2019a. Storm Events Database. <https://www.ncdc.noaa.gov/stormevents/>.

CONSTRUCTION AND OPERATIONS PLAN

References – Section 4 – Site Characterization and Assessment of Impacts

- NOAA NCEI. 2019b. International Best Track Archive for Climate Stewardship (IBTrACS). <https://www.ncdc.noaa.gov/ibtracs/index.php?name=ib-v4-access>.
- NOAA National Data Buoy Center (NDBC). 2020. Station 44017 – Climatic Summary Plots for air temperature. https://www.ndbc.noaa.gov/view_climplot.php?station=44017&meas=at.
- NOAA National Hurricane Center. 2020. Tropical Cyclone Climatology. <https://www.nhc.noaa.gov/climo/#uss>.
- NOAA National Ocean Service (NOS). 2020. Historical Hurricane Tracks. <https://coast.noaa.gov/hurricanes/#map=4/32/-80>.
- NOAA National Weather Service (NWS). 2018. National Weather Service Instruction 10-1605 Storm Data Preparation. <https://www.nws.noaa.gov/directives/sym/pd01016005curr.pdf>.
- Paskyabi, M.B. and I. Fer. 2012. Upper Ocean Response to Large Wind Farm Effect in the Presence of Surface Gravity Waves. Energy Procedia. 00: 1 – 10. https://folk.uib.no/ngfif/Reprints/Bakhoda_Fer_EnergyProcedia12.pdf.
- Rhode Island Coastal Resources Management Council (RI CRMC). 2010. Rhode Island Ocean Special Area Management Plan. Adopted by the RI CRMC on October 19, 2010. http://www.crmc.ri.gov/samp_ocean.html.
- Saha et al. 2010. The NCEP Climate Forecast System Reanalysis. American Meteorology Society. 2010. 44 pp. <https://journals.ametsoc.org/doi/pdf/10.1175/2010BAMS3001.1>.
- Segtnan, O.H., and K. Christakos. 2015. Effect of Offshore Windfarm Design on the Vertical Motion of the Ocean. Energy Procedia, Volume 80, Pages 213–222, ISSN 1876-6102, <https://dx.doi.org/10.1016/j.egypro.2015.11.424>.
- #### 5.4.3.2 Geological Conditions
- America, E.N. 2012. Development of the passive margin of eastern North America: Mesozoic rifting, igneous activity, and breakup. Regional Geology and Tectonics: Phanerozoic Rift Systems and Sedimentary Basins 1: 301.
- Bokuniewicz, H.J., J.J. Tanski, and L. Bocamazo. 2011. Sand Resources Offshore of Long Island (NY). Stonybrook University Conference Paper. https://www.researchgate.net/publication/268487530_SAND_RESOURCES_OFFSHORE_OF_LONG_ISLAND_NY.
- Bureau of Ocean Energy Management (BOEM). 2020a. Guidelines for Providing Geophysical, Geotechnical, and Geohazard Information Pursuant to 30 CFR Part 585. p. 26.
- Bureau of Ocean Energy Management (BOEM). 2020b. Guidelines for Providing Archaeological and Historic Property Information Pursuant to 30 CFR Part 585. May 27. p. 23.
- De Laguna, Wallace. 1965. U.S. Geological Survey. Geological Survey Bulletin 1165-A, Geology of Brookhaven National Laboratory and Vicinity, Suffolk County New York. <https://pubs.usgs.gov/bul/1156a/report.pdf>.

CONSTRUCTION AND OPERATIONS PLAN

References – Section 4 – Site Characterization and Assessment of Impacts

- Foster, D.S., B.A. Swift, and W.C. Schwab. 1999. Stratigraphic framework maps of the nearshore area of southern Long Island from Fire Island to Montauk Point, New York: U.S. Geological Survey Open-File Report 99-559, 3 sheets, scale 1:125,000.
- Fugro. 2016. Geosciences-Focused Desktop Study Bay State Offshore Windfarm Massachusetts Outer Continental Shelf.
- Fugro. 2018. Geophysical Survey and Shallow Hazards Report. South Fork Wind Farm and Export Cable, South Fork Wind Farm COP Survey Offshore NY/RI/MA, Atlantic OCS. Fugro Report No 02.1803-1431-01.
- Fugro. 2018. Integrated Geophysical and Geotechnical Site Characterization Report. South Fork Wind Farm and Export Cable, South Fork Wind Farm COP Survey Offshore NY/RI/MA, Atlantic OCS. Fugro Report No 02.1702-1080.
- Leatherman, S.P. 1985. Geomorphic and stratigraphic analysis of Fire Island, New York. G.F. Oertel and S.P. Leatherman, Barrier Islands. Marine. Geology. 63: 173--195.
<https://www.sciencedirect.com/science/article/pii/0025322785900830>.
- McMaster, R.L. and A.S.A.F. Ashraf. 1973. Drowned and buried valleys on the southern New England continental shelf. Marine Geology 15(4): 249-268.
- McMaster, R.L. 1984. Holocene stratigraphy and depositional history of the Narragansett Bay System Rhode Island, U.S.A. Sedimentology 31(6): 777-792.
- McMullen, K.Y., L.J. Poppe, E.R. Twomey, W.W. Danforth, T.A. Haupt, and J.M. Crocker. 2007a. Sidescan Sonar Imagery, Multibeam Bathymetry, and Surficial Geologic Interpretations of the Sea Floor in Rhode Island Sound, off Sakonnet Point, Rhode Island. USGS OpenFile Report 7007-1150.
https://www.researchgate.net/profile/Lj_Poppe/publication/265573545_Sidescan_Sonar_Imagery_Multibeam_Bathymetry_and_Surficial_Geologic_Interpretations_of_the_Sea_Floor_in_Rhode_Island_Sound_off_Sakonnet_Point_Rhode_Island/links/555c90df08ae86c06b5d394e.pdf. Accessed August 2020.
- McMullen, K.Y., L.J. Poppe, R.P. Signell, J.F. Denny, J.M. Crocker, A.L. Beaver, and P.T. Schattgen. 2007b. Surficial geology in central Narragansett Bay, Rhode Island—Interpretations of sidescan sonar and multibeam bathymetry. U.S. Geological Survey Open-File Report 2006-1199. Accessed November 11, 2019.
- McMullen, K.Y., L.J. Poppe, J.F. Denny, T.A. Haupt, and J.M. Crocker. 2008. Sidescan sonar imagery and surficial geologic interpretations of the sea floor in Central Rhode Island Sound. U.S. Geological Survey Open-File Report 2007-1366. Accessed October 10, 2019.
<https://pubs.er.usgs.gov/publication/ofr20071366>.
- McMullen, K.Y., L.J. Poppe, E.R. Twomey, W.W. Danforth, T.A. Haupt, and J.M. Crocker. 2011. Sidescan Sonar Imagery, Multibeam Bathymetry, and Surficial Geologic Interpretations of the Sea Floor in Rhode Island Sound, off Sakonnet Point, Rhode Island. U.S. Geological Survey Open File Report 2007-1150. <https://pubs.er.usgs.gov/publication/ofr20071150>.

CONSTRUCTION AND OPERATIONS PLAN

References – Section 4 – Site Characterization and Assessment of Impacts

- Needell, S.W., C.J. O'Hara, and H.J. Knebel. 1983. Maps showing geology and shallow structure of western Rhode Island Sound, Rhode Island: U.S. Geological Survey Miscellaneous Field Studies Map MF-1537. 11 p.
- Northeast States Emergency Consortium (NESEC). 2017a. Northeast Earthquake Facts. Accessed September 20, 2017. <http://nasec.org/earthquakes-hazards/>.
- NESEC. 2017b. New York Earthquakes. Accessed September 29, 2017. <http://nasec.org/new-york-earthquakes/>.
- Oakley, B.A. 2019. Persistence of Sorted Bedforms on the Glaciated Rhode Island Shoreface at the Weekly to Decadal Scale. *Coastal Sediments* 2186-2199.
- O'Hara, C.J., and R.N. Oldale. 1980. Maps showing geology and shallow structure of eastern Rhode Island Sound and Vineyard Sound, Massachusetts: Miscellaneous Field Studies Map M-F-1186. Woods Hole, Massachusetts: U.S. Geological Survey, Coastal and Marine Geology Program, Woods Hole Science Center.
- Panageotou, W. and S.P. Leatherman. 1986. Holocene-Pleistocene stratigraphy of the inner shelf off Fire Island, New York; implications for barrier island migration. *Journal of Sedimentary Research* 56(4): 528-537.
- Poppe, L.J., McMullen, K.Y., Danforth, W.W., Blankenship, M.A., Clos, A.R., Glomb, K.A., Lewit, P.G., Nadeau, M.A., Wood, D.A., and C.E. Parker. 2014. Combined multibeam and bathymetry data from Rhode Island Sound and Block Island Sound – A regional perspective: U.S. Geological Survey Open-File Report 2014-1012, DVD-ROM, 9 p., <https://dx.doi.org/10.3133/ofr20141012>. Accessed August 2020.
- Quinn, A.W. 1971. Bedrock Geology of Rhode Island. U.S. Geological Survey Bulletin 1295. p. 68.
- Rhode Island Coastal Resources Management Council (RI CRMC). 2010. Rhode Island Ocean Special Area Management Plan. Adopted by the RI CRMC on October 19, 2010. <http://seagrant.gso.uri.edu/oceansamp/documents.html>.
- Sanders, J. E., and C. Merguerian. 1994. The glacial geology of New York City and vicinity. In *The Geology of Staten Island, New York, Field guide and proceedings*. A. I. Benimoff, ed. The Geological Association of New Jersey, XI Annual Meeting. p. 296.
- Schwab, W.C., E.R. Thieler, J.F. Denny, and W.W. Danforth. 2000. Seafloor Sediment Distribution Off Southern Long Island New York. U.S. Geological Survey Open-File Report 00-243.
- Schwab W.C., W.E. Baldwin, J.F. Denny, C.J. Hapke, P.T. Gayes, J.H. List, and J.C. Warner. 2014. Modification of the Quaternary stratigraphic framework of the inner-continental shelf by Holocene marine transgression: An example offshore of Fire Island, New York. *Marine Geology* Volume 355, September 2014, Pages 346-360 <https://www.sciencedirect.com/science/article/pii/S0025322714001960?via%3Dihub>.
- Schwab, W., W. Baldwin, and J. Denny. 2016. Assessing the impact of Hurricanes Irene and Sandy on the morphology and modern sediment thickness on the inner continental shelf offshore of Fire Island, New York. Geological Survey Open-File Report, Volume 2015-1238, p. 15.

CONSTRUCTION AND OPERATIONS PLAN

References – Section 4 – Site Characterization and Assessment of Impacts

- Siegel, J., B. Dugan, D. Lizarralde, M. Person, W. DeFoor, and N. Miller. 2012. Geophysical evidence of a late Pleistocene glaciation and paleo-ice stream on the Atlantic Continental Shelf offshore Massachusetts, USA. *Marine Geology* 303: 63-74.
- Steckler, M.S., and A.B. Watts. 1978. Subsidence of the Atlantic-type continental margin off New York. *Earth and Planetary Science Letters* 41(1): 1-13.
- Swift, D.J.P. and W.R. Boehmer. 1972. Brown and Gray Sands on the Virginia Shelf: Color as a Function of Grain Size. *GSA Bulletin* 83(3).
- Taney, N.E., 1961. Geomorphology of the south shore of Long Island, New York. Tech. Mem. No. 128, Beach Erosion Board, Corps of Engineers. 50 pp.
- Tetra Tech. 2019. Sunrise Wind Offshore Seabed Desktop Data Analysis. Version 2.0.
- United States Army Corps of Engineers (USACE). 2016. Fire Island Inlet to Montauk Point, NY - Reformulation Study, Appendix B, Borrow Source Investigations. p. B-27.
- United States Department of Agriculture (USDA). 1975. Soil Survey of Suffolk County, New York. Soil Conservation Service in Cooperation with Cornell Agricultural Experiment Station.
- USGS. 2017. Nearshore Sediment Thickness, Fire Island, New York. Open File Report 2017-1024. <https://pubs.er.usgs.gov/publication/ofr20171024>.
- Veeger, A.I., H.E. Johnston, B.D. Stone, and L.A. Sirkin. 1996. Hydrogeology and Water Resources of Block Island, Rhode Island, U.S. Geological Survey. Water-Resources Investigation Report 94-4096.
- Williams, S.J., 1976. Geomorphology, shallow subbottom structure, and sediments of the Atlantic inner continental shelf off Long Island, New York. Tech. Pap. No. 76-2, U.S. Army Corps of Engineers, Coastal Engineering Research Center, 123 pp.
- Wynn, R.B., and D.A.V. Stow. 2002. Classification and characterisation of deep-water sediment waves. *Marine Geology* 192(1-3).

5.4.3.3 Water Quality

- Balthis, W.L., J.L. Hyland, M.H. Fulton, E.F. Wirth, J.A. Kiddon, and J. Macauley. 2009. Ecological Condition of Coastal Ocean Waters Along the U.S. Mid-Atlantic Bight: 2006. NOAA Technical Memorandum NOS NCCOS 109. U.S. Department of Commerce, National Oceanic and Atmospheric Administration, National Ocean Service, Charleston, SC.
- Bricker, S.B., C.G. Clement, D.E. Pirhalla, S.P. Orlando, and D.R.G. Farrow. 1999. National Estuarine Eutrophication Assessment: Effects of Nutrient Enrichment in the Nation's Estuaries. NOAA, National Ocean Service, Special Projects Office and the National Centers for Coastal Ocean Science. Silver Spring, MD: 71 pp.

CONSTRUCTION AND OPERATIONS PLAN

References – Section 4 – Site Characterization and Assessment of Impacts

- Bureau of Ocean Energy Management (BOEM). 2013. Commercial Wind Lease Issuance and Site Assessment Activities on the Atlantic Outer Continental Shelf Offshore Rhode Island and Massachusetts. Revised Environmental Assessment. OCS EIS/EA BOEM 2013-1131. 417 pp.
https://www.boem.gov/sites/default/files/uploadedFiles/BOEM/Renewable_Energy_Program/State_Activities/BOEM%20RI_MA_Revised%20EA_22May2013.pdf.
Accessed April 3, 2020.
- Climate Central. 2013. Sewage Overflows from Hurricane Sandy.
<https://www.climatecentral.org/pdfs/Sewage.pdf>. Accessed April 3, 2020.
- Committee on Natural Resources and Environment. 2010. Committee on Environment and Natural Resources. 2010. Scientific Assessment of Hypoxia in U.S. Coastal Waters. Interagency Working Group on Harmful Algal Blooms, Hypoxia, and Human Health of the Joint Subcommittee on Ocean Science and Technology. Washington, DC.
- Doney, S.C., V.J. Fabry, R.A. Freely, and J.A. Kleypas. 2009. Ocean acidification: the other CO₂ problems. *Annual Review of Marine Science* 1:169-92.
- Environmental Protection Agency (EPA). n.d-a. Managing Ocean Dumping in EPA Region 2.
<https://www.epa.gov/ocean-dumping/managing-ocean-dumping-epa-region-2>.
Accessed April 1, 2020.
- EPA. n.d-b. Sole source aquifer mapper.
<https://epa.maps.arcgis.com/apps/webappviewer/index.html?id=9ebb047ba3ec41ada1877155fe31356b>. Accessed April 2, 2020.
- EPA. 2012. National Coastal Condition Report IV. EPA-842-R-10-003.
https://www.epa.gov/sites/production/files/2014-10/documents/0_nccr_4_report_508_bookmarks.pdf. Accessed April 1, 2020.
- Environmental Systems Research Institute (Esri). n.d. Ecological Marine Units.
<https://www.esri.com/en-us/about/science/ecological-marine-units/overview>.
Accessed April 1, 2020.
- Feeley, R.A., C.L. Sabine, K. Lee, W. Berelson, J. Kleypas, V.J. Fabry, and F.J. Millero. 2004. Impact of Anthropogenic CO₂ on the CaCO₃ System in the Oceans. *Science* 305(5682):362-366.
- Kavanaugh, M.T., J.E. Rheuban, K.M.A. Luis, and S.C. Doney. 2017. Thirty-Three Years of Ocean Benthic Warming Along the U.S. Northeast Continental Shelf and Slope: Patterns, Drivers, and Ecological Consequences. *Journal of Geophysical Research: Oceans*, 122, 9399–9414. <https://doi.org/10.1002/2017JC012953>.
- Kinney, E.L. and I. Valiela. 2011. Nitrogen Loading to Great South Bay: Land Use, Sources, Retention, and Transport from Land to Bay. *Journal of Coastal Research* 27. Pp. 672–686.
- Long Island Commission for Aquifer Protection (LICAP). 2016. State of the Aquifer 2016.
http://liaquifercommission.com/images/SOTA_PowerPoint_Presentation_100516-2.pdf.
Accessed April 1, 2020.

CONSTRUCTION AND OPERATIONS PLAN

References – Section 4 – Site Characterization and Assessment of Impacts

- LICAP. 2017. Wastewater Management in Nassau and Suffolk Counties, New York. http://www.liaquifercommission.com/images/Wastewater_Management_Report.pdf. Accessed April 2, 2020.
- Marine Cadastre. 2019. Ocean Area Ocean Reports, Oceanographical and Biophysical Data for Custom Area, Offshore. <https://marinecadastre.gov/oceanreports/@-7977579.768067291,4938290.649392105/8/eyJ0ljojYm8iLCJljoib2NIYW4iLCJmljowLCJzljowLCJhlioiZjQ3NDU0Mzk1OWJlNGYwOGE4N2Y5ZjI0MjkwYWY0OWMiLCJsljpbODBdfQ==>. Accessed May 5, 2020.
- New York State (NYS). n.d. Parks, Recreation and Historic Preservation, Water Quality – Beach Results. Accessed August 2020. <https://parks.ny.gov/recreation/swimming/beach-results/>.
- New York State (NYS). 2019. Latest Beach Results: Thursday, October 10, 2019. <https://parks.ny.gov/recreation/swimming/beach-results/documents/results/BeachResults.pdf>. Accessed April 2, 2020.
- Nixon, D. Graduate School of Oceanography, University of Rhode Island. Personal Communication on April 8, 2010 as cited in RI SAMP 2010.
- National Oceanic and Atmospheric Administration (NOAA). n.d.-a. OceanReports Tool Brings Ocean Data to your Fingertips. <https://oceanservice.noaa.gov/ocean/ocean-reports/>. Accessed April 1, 2020.
- NOAA. n.d.-b. East Coast: Harmful Algal Blooms. <https://oceanservice.noaa.gov/hazards/hab/east-coast.html>. Accessed April 1, 2020.
- NOAA. 2019. State of the Ecosystem 2019: Mid-Atlantic. https://static1.squarespace.com/static/511cdc7fe4b00307a2628ac6/t/5c9e16a67817f735bab0e23f/1553864370795/Tab09_State+of+the+Ecosystem+Report_2019-04.pdf. Accessed April 1, 2020.
- Northeast Oceans Data. n.d. Water Quality Mapper. <https://www.northeastoceandata.org/data-explorer/?water-quality|no-discharge-zones>. Accessed April 2, 2020.
- National Park Service. 2005. Water Quality and Ecology of Great South Bay (Fire Island National Seashore Science Synthesis Paper) Technical Report NPS/NER/NRTR—2005/019. <http://npshistory.com/publications/fiis/nrtr-2005-019.pdf>. Accessed April 2, 2020.
- New York State Department of Environmental Conservation (NYSDEC). n.d.-a. New York's Marine & Coastal District Waters. <https://www.dec.ny.gov/permits/95483.html>. Accessed July 20, 2020.
- NYSDEC. n.d.-b. Harmful Algal Blooms and Marine Biotoxins. <https://www.dec.ny.gov/outdoor/64824.html>. Accessed April 2, 2020.
- NYSDEC. n.d.-c. New York Ocean Action Plan. <https://www.dec.ny.gov/lands/84428.html>. Accessed April 2, 2020.
- NYSDEC. n.d.-d. Long Island Aquifers. <https://www.dec.ny.gov/lands/36183.html>. Accessed April 2, 2020.

CONSTRUCTION AND OPERATIONS PLAN

References – Section 4 – Site Characterization and Assessment of Impacts

- NYSDEC. 2010. New York State Stormwater Management Design Manual. www.dec.ny.gov/docs/water_pdf/swdm2010entire.pdf. Accessed April 2, 2020.
- NYSDEC. 2016. The Final New York State 2016 Section 303(d) List of Impaired Waters Requiring a TMDL/Other Strategy. http://www.dec.ny.gov/docs/water_pdf/303dListfinal2016.pdf. Accessed April 2, 2020.
- NYSDEC. 2019. Harmful Algal Blooms by County, 2012-2018. https://www.dec.ny.gov/docs/water_pdf/habextentsummary.pdf. Accessed April 2, 2020.
- New York State Department of Health (NYSDOH). 2012. Health advice on eating sportfish and game 2011-2012. <https://www.health.ny.gov/publications/2800.pdf>. Accessed April 3, 2020.
- Rhode Island Coastal Resources Management Council (RI CRMC). 2010. Rhode Island Ocean Special Area Management Plan. Adopted by the RI CRMC on October 19, 2010. <http://seagrant.gso.uri.edu/oceansamp/documents.html>. Accessed April 1, 2020.
- Rhode Island Department of Environmental Management (RIDEM). 2010. Water Quality Regulations, July 2006, Amended December 2010. <http://www.dem.ri.gov/pubs/regs/regs/water/h2oq10.pdf>. Accessed April 3, 2020.
- Saba, V.S., S.M. Griffies, W.G. Anderson, M. Winton, M.A. Alexander, T.L. Delworth, and R. Zhang. 2016. Enhanced warming of the Northwest Atlantic Ocean under climate change. *Journal of Geophysical Research-Oceans*, 121(1), 118-132.
- Staker, R.D., and S.F. Bruno. 1977. Phytoplankton in coastal waters off Eastern Long Island (Block Island Sound) Montauk, N.Y. New York Ocean Science Laboratory.
- Suffolk County. 2020a. Marine Water Quality monitoring. <https://www.suffolkcountyny.gov/Departments/Health-Services/Environmental-Quality/Ecology/Marine-Water-Quality-Monitoring>. Accessed April 2, 2020.
- Suffolk County. 2020b. Harmful Algal Blooms. <https://www.suffolkcountyny.gov/Departments/Health-Services/Environmental-Quality/Ecology/Harmful-Algal-Blooms>. Accessed April 1, 2020.
- Suffolk County Department of Health Services (SCDHS). 2019a. Surface water quality monitoring data provided by the SCDHS Office of Ecology, Yaphank, N.Y. <https://www.peconicestuary.org/protect-the-peconic/monitoring-programs/>. Accessed April 2, 2020.
- SCDHS. 2019b. Surface water quality monitoring data provided by the SCDHS Office of Ecology, Yaphank, N.Y. <https://gisportal.suffolkcountyny.gov/gis/home/item.html?id=4d35513248524444a752bc0b4ce9b26e>. Accessed April 2, 2020.
- SwimGuide. 2020. Smith Point County Park. <https://www.theswimguide.org/beach/2644>. Accessed April 3, 2020.

CONSTRUCTION AND OPERATIONS PLAN

References – Section 4 – Site Characterization and Assessment of Impacts

- The Nature Conservancy (TNC). 2018. Oxygen Levels in Parts of Great South Bay Seasonally Dip Below Levels Needed to Support Sea-life. <https://www.nature.org/en-us/newsroom/oxygen-levels-in-parts-of-great-south-bay-seasonally-dip-below-/>. Accessed April 1, 2020.
- United States Army Corps of Engineers (USACE). 2004. Final Environmental Impact Statement for the Rhode Island Region Long-Term Dredged Material Disposal Site Evaluation Project. Appendix C, Final Site Management and Monitoring Plan.
- USACE. 2004. Final Environmental Impact Statement for the Rhode Island Region Long-Term Dredged Material Disposal Site Evaluation Project. Appendix C, Final Site Management and Monitoring Plan.
- USACE. 2015a. Final Programmatic Environmental Impact Statement for Dredged Material Management Plan, Long Island Sound Connecticut, New York and Rhode Island. <https://www.nae.usace.army.mil/portals/74/docs/Topics/LISDMMP/LISDMMP%20Final/02-LIS-PEIS-Final-Dec15.pdf>. Accessed April 1, 2020.
- USACE. 2015b. New York and New Jersey Harbor Deepening Project Dredge Plume Dynamics in New York/New Jersey Harbor, Summary of Suspended Sediment Plume Surveys Performed during Harbor Deepening. https://www.nan.usace.army.mil/Portals/37/docs/harbor/Biological%20and%20Physical%20Monitoring/Total%20Suspended%20Sediments%20Monitoring/TSS%20Summary%20Report_FINAL_21April2015.pdf. Accessed July 17, 2020.
- United States Geological Survey (USGS). 2016. Long Island South Shore Estuary Reserve Coordinated Water Resources Monitoring Strategy. <https://pubs.usgs.gov/of/2017/1161/ofr20171161.pdf>. Accessed April 2, 2020.
- USGS. 2019. New York Active Water Level Network. <https://groundwaterwatch.usgs.gov/statemap.asp?sc=36&sa=NY>. Accessed April 2, 2020.
- Vezzulli, L., C. Grande, P.C. Reid, P. Helaouet, M. Edwards, M.G. Hofled, I. Brettard, R.R. Colwelle, and C. Pruzzo. 2016. Climate influence on Vibrio and associated human diseases during the past half-century in the coastal North Atlantic. PNAS E5062-E5071. <https://www.pnas.org/content/pnas/113/34/E5062.full.pdf>. Accessed April 3, 2020.

5.4.3.4 Air Quality

- Abt Associates. 2020. The Emissions & Generation Resource Integrated Database for 2018 (eGRID2018), prepared for the U.S. Environmental Protection Agency, Washington, DC, January 2020.
- Bureau of Ocean Energy Management (BOEM). 2013. Commercial Wind Lease Issuance and Site Assessment Activities on the Atlantic Outer Continental Shelf Offshore Rhode Island and Massachusetts, Revised Environmental Assessment. U.S. Department of the Interior, Office of Renewable Energy Programs. BOEM 2013-1131.

CONSTRUCTION AND OPERATIONS PLAN

References – Section 4 – Site Characterization and Assessment of Impacts

- Connecticut Department of Energy and Environmental Protection (CT DEEP). 2018. 2016 Connecticut Greenhouse Gas Emissions Inventory, supporting data. Office of Climate Change, Technology and Research. Retrieved from https://www.ct.gov/deep/cwp/view.asp?a=4423&Q=568752&deepNav_GID=2121.
- Executive Climate Change Coordinating Council (EC4). 2016. Rhode Island Greenhouse Gas Emissions Reduction Plan. Retrieved from <http://climatechange.ri.gov/state-actions/reducing-emissions.php>.
- Maryland Department of the Environment (MDE). 2019. The Greenhouse Gas Emissions Reduction Act 2019 GGRA Draft Plan. Retrieved from [https://mde.maryland.gov/programs/Air/ClimateChange/Pages/2019-Greenhouse-Gas-Emissions-Reduction-Act-\(GGRA\)-Draft-Plan.aspx](https://mde.maryland.gov/programs/Air/ClimateChange/Pages/2019-Greenhouse-Gas-Emissions-Reduction-Act-(GGRA)-Draft-Plan.aspx).
- Massachusetts Department of Environmental Protection (MassDEP). 2017. Statewide Greenhouse Gas Emissions Level: 1990 Baseline and 2020 Business As Usual Projection Update, Appendix C: Massachusetts Annual Greenhouse Gas Emissions Inventory: 1990-2017, with Partial 2018 Data. Dated January 2020. Retrieved from <https://www.mass.gov/lists/massdep-emissions-inventories>.
- New Jersey Department of Environmental Protection (NJDEP). 2017. 2015 Statewide Greenhouse Gas Emissions Inventory. Retrieved from <https://www.nj.gov/dep/ages/oce-publications.html>.
- New York State Energy Research and Development Authority (NYSERDA). 2019. New York State Greenhouse Gas Inventory: 1990-2016. Retrieved from <https://www.dec.ny.gov/energy/99223.html>.
- New York State (NYS). 2015. 2015 New York State Energy Plan. Retrieved from <https://energyplan.ny.gov/Plans/2015.aspx>.
- State of Massachusetts. 2008. *Global Warming Solutions Act*.
- United States Department of Commerce (DOC). 2019. Thirteenth Edition. Distances between United States Ports. Retrieved from <https://nauticalcharts.noaa.gov/publications/docs/distances.pdf>.
- United States Environmental Protection Agency (USEPA). 2020. Ambient Monitoring Archive (AMA). Retrieved from <https://www3.epa.gov/ttnamti1/toxdat.html>.
- USEPA. Monitor Values Report (MVR). 2017. Retrieved from <https://www.epa.gov/outdoor-air-quality-data/monitor-values-report-hazardous-air-pollutants>.
- USEPA. 2019. Nonattainment Areas for Criteria Pollutants (Green Book). Retrieved from <https://www.epa.gov/green-book/green-book-8-hour-ozone-2015-area-information>.

CONSTRUCTION AND OPERATIONS PLAN

References – Section 4 – Site Characterization and Assessment of Impacts

5.4.4 Biological Resources

5.4.4.1 Coastal and Terrestrial Habitat

- Bureau of Ocean Energy Management (BOEM). 2013. Commercial Wind Lease Issuance and Site Assessment Activities on the Atlantic Outer Continental Shelf Offshore Rhode Island and Massachusetts, Revised Environmental Assessment. Office of Renewable Energy Programs. OCS EIS/EA. BOEM 2013-1131. May.
- Edinger, G.J., D.J. Evans, S. Gebauer, T.G. Howard, D.M. Hunt, and A.M. Olivero (editors). 2014. Ecological Communities of New York State. Second Edition. A revised and expanded edition of Carol Reschke's *Ecological Communities of New York State*. New York Natural Heritage Program, New York State Department of Environmental Conservation, Albany, NY.
- New York State Department of Environmental Conservation (NYSDEC). 2008a. Coastal Fish & Wildlife Habitat Assessment Form – Smith Point County Park. December 15. Available at: https://www.dos.ny.gov/opd/programs/consistency/Habitats/LongIsland/Smith_Point_County_Park.pdf.
- NYSDEC. 2008b. Coastal Fish & Wildlife Habitat Assessment Form – Great South Bay-East. December 15. Available at: https://www.dos.ny.gov/opd/programs/consistency/Habitats/LongIsland/Great_South_Bay_East.pdf.
- NYSDEC. 2008c. Coastal Fish & Wildlife Habitat Assessment Form – Moriches Bay. December 15. Available at: https://www.dos.ny.gov/opd/programs/consistency/Habitats/LongIsland/Moriches_Bay.pdf.
- NYSDEC. 2008d. Coastal Fish & Wildlife Habitat Assessment Form – Carmans River. December 15. Available at: https://www.dos.ny.gov/opd/programs/consistency/Habitats/LongIsland/Carmans_River.pdf.
- New York Department of State (NYSDOS). 1984. Technical Memorandum: Procedures Used To Identify, Evaluate and Recommend Areas For Designation As "Significant Coastal Fish And Wildlife Habitats." Accessed June 8, 2020. June 8, 2020. https://www.dos.ny.gov/opd/programs/pdfs/1984_SCFWH_technical_memorandum.pdf.
- New York Natural Heritage Program (NYNHP). 2020. Online Conservation Guide for Red maple-blackgum swamp. Available from: <https://guides.nynhp.org/red-maple-blackgum-swamp/>. Accessed June 8, 2020.
- U.S. Department of the Interior, Minerals Management Service (DOI-MMS). 2007. Final Programmatic Environmental Impact Statement for Alternative Energy Development and Production and Alternate Use Facilities on the Outer Continental Shelf. OCS EIS/EA MMS 2007-046.

CONSTRUCTION AND OPERATIONS PLAN

References – Section 4 – Site Characterization and Assessment of Impacts

- U.S. Department of the Interior, National Park Service (NPS). 2015. Fire Island National Seashore Draft General Management Plan/Environmental Impact Statement. Available at: <https://parkplanning.nps.gov/document.cfm?parkID=227&projectID=16782&documentID=66653>.
- U.S. Geological Survey (USGS). 2013. Coastal change from Hurricane Sandy and the 2012–13 winter storm season—Fire Island, New York: U.S. Geological Survey Open-File Report 2013-1231, 37 p.
- U.S. Fish and Wildlife Service (USFWS). 1997. Significant Habitats and Habitat Complexes of the New York Bight Watershed. Southern New England - New York Bight Coastal Ecosystems Program. Charlestown, Rhode Island. Completed November 1996. Published November 1997. <https://nctc.fws.gov/pubs5/begin.htm>. Accessed April 9, 2020.

5.4.4.2 Benthic and Shellfish Resources

- AKRF, Inc., AECOM, and A. Popper. 2012. Essential Fish Habitat Assessment for the Tappan Zee Hudson River Crossing Project.
- Albert, L., F. Deschamps, A. Jolivet, F. Olivier, L. Chauvaud, and S. Chauvaud. 2020. A current synthesis on the effects of electric and magnetic fields emitted by submarine power cables on invertebrates. *Marine Environmental Research* 159: 10495.
- André, M., K. Kaifu, M. Solé, M. van der Schaar, T. Akamatsu, A. Balastegui, A.M. Sánchez, and J.V. Castell. 2016. Contribution to the Understanding of Particle Motion Perception in Marine Invertebrates. In: A.N. Popper and A. Hawkins (eds.), *The Effects of Noise on Aquatic Life II*. Springer New York, New York, NY. pp 47-55.
- APTIM. 2018. Inventory of potential beach nourishment and coastal restoration sand resources on the Atlantic Outer Continental Shelf; Atlantic Sand Assessment Project (ASAP); Final Report of Findings. Prepared by APTIM Environmental & Infrastructure, INC., 101 16th Avenue South, Suite 6, Saint Petersburg, FL 33701. Prepared for United States Department of Interior, Bureau of Ocean Energy Management, 45600 Woodland Rd., Sterling, VA 20166. Contract Number M14PC00006, November 17, 2017.
- Archambault, M.-C., V.M. Bricelj, J. Grant, and D.M. Anderson. 2004. Effects of suspended and sedimented clays on juvenile hard clams, *Mercenaria mercenaria*, within the context of harmful algal bloom mitigation. *Marine Biology* 144(3): 553-565.
- Barnes, D. 2018. Long Island Shellfish Restoration Project [Slide Presentation] <https://seagrant.sunysb.edu/Images/Uploads/PDFs/HABsWorkshop-0518/09-Barnes-1110.pdf>
- Bay State Wind LLC. 2019. Construction and Operations Plan, Bay State Offshore Wind Farm. Submitted to Bureau of Ocean Energy Management. Submitted by Bay State Wind LLC. Submitted March 2019, Revised July 2019.
- Betke, K., Schultz-von Glahn, M., & Matuschek, R. 2004. Underwater noise emissions from offshore wind turbines. Presented at the Proceedings of the joint congress CFA/DAGA'04, Strasbourg, France.

CONSTRUCTION AND OPERATIONS PLAN

References – Section 4 – Site Characterization and Assessment of Impacts

- Bricelj, V., S. MacQuarrie, and R. Schaffner. 2001. Differential effects of *Aureococcus anophagefferens* isolates ("brown tide") in unialgal and mixed suspensions on bivalve feeding. *Marine Biology* 139: 605–616.
- Brooks, R.A., C.N. Purdy, S.S. Bell, and K.J. Sulak. 2006. The benthic community of the eastern US continental shelf: A literature synopsis of benthic faunal resources. *Continental Shelf Research* 26(6): 804-818.
- Bochert, R., and M.L. Zettler. 2004. Long-Term Exposure of Several Marine Benthic Animals to Static Magnetic Fields. *Bioelectromagnetics* 25: 498-502.
- Boesch, D.F., J.N. Kraeuter, and D.K. Serafy. 1977. Benthic Ecological Studies: Megabenthos and Macrobenthos, Chapter 6. Middle Atlantic Outer Continental Shelf Environmental Studies, vol. II. Chemical and biological benchmark studies. In: Boesch et al. (Eds.), *Distribution and Structure of Communities of Macrobenthos on the Outer Continental Shelf of The Middle Atlantic Bight: 1975–1973 Investigations*. U.S. Department of Interior Bureau of Land Management, Contract No. 08550-CT-5-42.
- Bureau of Ocean Energy Management (BOEM). 2013. Commercial Wind Lease Issuance and Site Assessment Activities on the Atlantic Outer Continental Shelf Offshore Rhode Island and Massachusetts. Revised Environmental Assessment. OCS EIS/EA BOEM 2013-1131. 417 pp. Accessed April 3, 2020.
https://www.boem.gov/sites/default/files/uploadedFiles/BOEM/Renewable_Energy_Program/State_Activities/BOEM%20RI_MA_Revised%20EA_22May2013.pdf.
- BOEM. 2015. Virginia Offshore Wind Technology Advancement Project on the Atlantic Outer Continental Shelf Offshore Virginia Revised Environmental Assessment: p. 239.
- BOEM Office of Renewable Energy Programs. 2019. Guidelines for Providing Benthic Habitat Survey Information for Renewable Energy Development on the Atlantic Outer Continental Shelf Pursuant to 30 CFR Part 585. June 2019.
- Cargnelli, L.M., S.J. Griesbach, D.B. Packer, E. Weissberger. 1999. Essential fish habitat source document: Atlantic surfclam, *Spisula solidissima*, life history and habitat characteristics. NOAA Tech. Memo. NMFSNE-142; 13 p.
- Claudet, J. and D. Pelletier. 2004. Marine protected areas and artificial reefs: a review of the interactions between management and scientific studies. *Aquatic Living Resources* 17: 129–138.
- CoastalVision and Germano & Associates. 2010. Sediment Profile & Plan View Imaging Report: Evaluation of Sediment and Benthos Characteristics along Potential Cable Routes and Turbine Locations for the Proposed Block Island Wind Farm. Report prepared for Deepwater Wind, Providence, RI.
- Collie, J.S. and J.W. King. 2016. Spatial and Temporal Distributions of Lobsters and Crabs in the Rhode Island Massachusetts Wind Energy Area. U.S. Dept. of the Interior, Bureau of Ocean Energy Management, Atlantic OCS Region, Sterling, Virginia. OCS Study BOEM 2016. Pp.073.

CONSTRUCTION AND OPERATIONS PLAN

References – Section 4 – Site Characterization and Assessment of Impacts

- Coolen, J.W.P., B. Van der Weide, J. Cuperus, M. Blomberg, G.W.M.N Van Moorsel, M.A. Faasse, and O.G. Bos. 2018. Benthic biodiversity on old platforms, young wind farms, and rocky reefs. *ICES Journal of Marine Science*, doi:10.1093/icesjms/fsy092.
- Copping A., N. Sather, L. Hanna, J. Whiting, G. Zydlewski, G. Staines, A. Gill, I. Hutchison, A. O'Hagan, T. Simas, J. Bald, C. Sparling, J. Wood, and E. Masden. 2016. Annex IV 2016 State of the Science Report: Environmental Effects of Marine Renewable Energy Development Around the World. Cranford, P.J., and D.C. Gordon Jr. 1992. The influence of dilute clay suspensions on sea scallop (*Placopecten magellanicus*) feeding activity and tissue growth. *Netherlands Journal of Sea Research* 30: 107-120.
- Cutler Jr., G.R., and R.J. Diaz. 1998. Benthic habitats and biological resources off the Virginia coast 1996 and 1997. In: Hobbs III, C.H. (Ed.), *Environmental Studies Relative to Potential Sand Mining in the Vicinity of the City of Virginia Beach, Virginia*. U.S. Department of Interior Minerals Management Service, Agreement 14-35-0001-3087.
- Dannheim, J., M.L. Bergstro, S.N.R. Birchenough, R. Brzana, A.R. Boon, J.W.P. Coolen, J.C. Dauvin, I. De Mesel, J. Derweduwen, A.B. Gill, Z.L. Hutchison, A.C. Jackson, U. Janas, G. Martin, A. Raoux, J. Reubens, L. Rostin, J. Vanaverbeke, T.A. Wilding, D. Wilhelmsson, and S. Degraer. 2019. Benthic effects of offshore renewables: identification of knowledge gaps and urgently needed research. – *ICES Journal of Marine Science*. doi:10.1093/icesjms/fsz018.
- De Backer, A., and K. Hostens. 2017. Effects of Belgian offshore wind- farms on soft sediment epibenthos and fish: an updated time series. In *Environmental Impacts of Offshore Wind Farms in the Belgian Part of the North Sea: A Continued Move Towards Integration and Quantification*, pp. 59–71. Ed. by S., Degraer, R., Brabant, B., Rumes, and L. ViginRoyal Belgian Institute of Natural Sciences, OD Natural Environment, Marine Ecology and Management Section, Brussels. 141 pp.
- Deepwater Wind South Fork, LLC. 2019. Appendix H4 of Volume II, Construction and Operations Plan South Fork Wind Farm. Submitted to Bureau of Ocean Energy Management, Sterling, VA. Submitted by Deepwater Wind South Fork, LLC. Revision 3: February 2019.
- De Mesel, I., F. Kerckhof, A. Norro, B. Rumes, and S. Degraer. 2015. Succession and seasonal dynamics of the epifauna community on offshore wind farm foundations and their role as stepping stones for non-indigenous species. *Hydrobiologia*, 756: 37–50.
- Department of the Interior. 2020. Continental Margin Mapping Program (CONMAP) sediments grainsize distribution for the United States East Coast Continental Margin (CONMAPSG). Accessed April 2020. <https://catalog.data.gov/dataset/continental-margin-mapping-program-conmap-sediments-grainsize-distribution-for-the-united-state>.
- Dernie, K.M., M.J. Kaiser, and R.M. Warwick. 2003. Recovery rates of benthic communities following physical disturbance. *Journal of Annual Ecology*, 72: 1043-1056.
- DWW Rev I, LLC. 2020. Appendix T of Volume II, Construction and Operations Plan Revolution Wind Farm Project. Submitted to Bureau of Ocean Energy Management, Sterling, VA. Submitted by DWW Rev I, LLC. March 2020.
- Federal Geographic Data Committee (FGDC). 2012. FGDC-STD-018-2012. Coastal and Marine Ecological Classification Standard. Reston, VA.

CONSTRUCTION AND OPERATIONS PLAN

References – Section 4 – Site Characterization and Assessment of Impacts

- Fisheries Hydroacoustic Working Group. 2008. Agreement in Principle for Interim Criteria for Injury to Fish from Pile Driving Activities. 12 Jun 2008 edition.
http://www.dot.ca.gov/hq/env/bio/files/fhwgcriteria_agree.pdf.
- Fortune, I.S. and D.M Paterson. 2020. Ecological best practice in decommissioning: a review of scientific research. ICES Journal of Marine Science. 77(3): 1079109.
<https://doi.org/10.1093/icesjms/fsy130>.
- Germano, J., J. Parker, and J. Charles. 1994. Monitoring cruise at the Massachusetts Bay Disposal Site, August 1990. DAMOS Contribution No. 92. U.S. Army Corps of Engineers, New England Division. Waltham, Massachusetts.
- Gill, A.B., M. Bartlett, and F. Thomsen. 2012. Potential interactions between diadromous fishes of U.K. conservation importance and the electromagnetic fields and subsea noise from marine renewable energy developments. *Journal of Fish Biology* 81: 664–695.
- Gill, A.B., I. Gloyne-Philips, J. Kimber, and P. Sigray. 2014. Marine Renewable Energy, Electromagnetic (EM) Fields and EM-Sensitive Animals. *Marine Renewable Energy Technology and Environmental Interactions*. M. A. Shields and A. I. L. Payne. Dordrecht, Springer: 61-79.
- Gobler C.J., C.S. Young, J. Goleski, A. Stevens, J. Thickman, R.B. Wallace, P. Curran, F. Koch, Y. Kang, M. W. Lusty, T. K. Hatterrath-Lehmann, K. Langlois, J. L. Collier. 2019. Accidental ecosystem restoration? Assessing the estuary-wide impacts of a new ocean inlet created by Hurricane Sandy. *Estuarine, Coastal and Shelf Science* 221: 132-146.
- Goff, J.A., R.D. Flood, J.A. Austin, W.C. Schwab, B. Christensen, C.M. Browne, J.F. Denny, and W.E. Baldwin. 2015. The impact of Hurricane Sandy on the shoreface and inner shelf of Fire Island, New York: Large bedform migration but limited erosion. *Continental Shelf Research* 98: 13-25.
- Greene, H.G., J.J. Bizarro, V.M. O'Connell, and C.K. Brylinsky. 2007. Construction of digital potential marine benthic habitat maps using a coded classification scheme and its applications. In Todd, B.J. and H.G. Greene, eds., *Mapping the Seafloor for Habitat Characterization: Geological association of Canada, Special Paper 47*, p. 147-162.
- Greene, J.K., Anderson, M.G., Odell, J., and Steinberg, N., eds. 2010. *The Northwest Atlantic Marine Ecoregional Assessment: Species, Habitats and Ecosystems. Phase One. The Nature Conservancy, Eastern U.S. Division, Boston, MA.*
- Griswold, C.A. and J. Prezioso. 1981. In-situ observations on reproductive behavior of the longfinned squid, *Loligo pealei*. *Fishery Bulletin* 78: 945–947.
- Groner, M.L., J.D. Shields, D.F. Landers, J. Swenarton, and J.M. Hoenig. 2018. Rising Temperatures, Molting Phenology, and Epizootic Shell Disease in the American Lobster. *American Naturalist* 192(5): E163-E177.
- Guarinello, M. and D. Carey. 2020. Multi-modal approach for benthic impact assessments in moraine habitats: A case study at the Block Island Wind Farm. *Estuaries and Coasts*.

CONSTRUCTION AND OPERATIONS PLAN

References – Section 4 – Site Characterization and Assessment of Impacts

- Guida, V., A. Drohan, H. Welch, J. McHenry, D. Johnson, V. Kentner, J. Brink, D. Timmons, and E. Estela-Gomez. 2017. Habitat Mapping and Assessment of Northeast Wind Energy Areas. Sterling, VA: US Department of the Interior, Bureau of Ocean Energy Management. OCS Study BOEM 2017-088. 312 p.
- Hart DR, Chute AS. Essential Fish Habitat Source Document: Sea scallop, *Placopecten magellanicus*, life history and habitat characteristics, 2nd ed. NOAA Tech. Memo. 2004; NMFS-NE-189.
- Hawkins, A.D., A.E. Pembroke, and A.N. Popper. 2015. Information gaps in understanding the effects of noise on fishes and invertebrates. *Rev Fish Biol Fisheries* 25, 39–64. <https://doi.org/10.1007/s11160-014-9369-3>.
- HDR. 2020. Benthic and Epifaunal Monitoring During Wind Turbine Installation and Operation at the Block Island Wind Farm, Rhode Island – Project Report. Final Report to the U.S. Department of the Interior, Bureau of Ocean Energy Management, Office of Renewable Energy Programs. OCS Study BOEM 2020- 044. 263 pp.
- Hirsch, N.D., L.H. DiSalvo, and R. Peddicord. 1978. Effects of dredging and disposal on aquatic organisms. Technical Report DS-78-5. U.S. Army Engineer Waterways Experiment Station. Vicksburg, MS. NTIS No. AD A058 989.
- Hu, M.Y., H.Y. Yan, W.S. Chung, J.C. Shiao, and P.P. Hwang. 2009. Acoustically evoked potentials in two cephalopods inferred using the auditory brainstem response (ABR) approach. *Comparative Biochemistry and Physiology Part A: Molecular & Integrative Physiology*. 153:278-283.
- Hutchison, Z.L., P. Sigray, H. He, A. Gill, J. King, and C. Gibson. 2018. Electromagnetic Field (EMF) Impacts on Elasmobranch (shark, rays, and skates) and American Lobster Movement and Migration from Direct Current Cables. Sterling, VA. BOEM 2018-003: 254 pages.
- Hutchison, Z.L., A.B. Gill, P. Sigray, H. He, and J.W. King. 2020. Anthropogenic electromagnetic fields (EMF) influence the behaviour of bottom-dwelling marine species. *Scientific Reports* DOI:10.1038/s41598-020-60793-x
- INSPIRE Environmental. 2016. Hard Bottom Baseline and Post-Construction Surveys, Year 0 Report for 2015 Baseline and 2016 Post-Construction Surveys to Characterize Potential Impacts and Response of Hard Bottom Habitats to Anchor Placement at the Block Island Wind Farm (BIWF). Prepared by INSPIRE Environmental, Middletown, RI for Deepwater Wind Block Island, LLC, Providence, RI. 98 pp.
- Jaini, M., R.A. Wahle, A.C. Thomas, and R. Weatherbee. 2018. Spatial surface temperature correlates of American lobster (*Homarus americanus*) settlement in the Gulf of Maine and southern New England shelf. *Bull. Mar. Sci.* 94:737-751.
- Johnson, J.H., D.S. Dropkin, B.E. Warkentine, J.W. Rachlin and W.D. Andrews. 1997. Food Habits of Atlantic Sturgeon off the Central New Jersey Coast. *Transactions of the American Fisheries Society* 126(1): 166-170.
- Jones, I.T., J.A. Stanley, and T.A. Mooney. 2020. Impulsive pile driving noise elicits alarm responses in squid (*Doryteuthis paeleii*). *Marine Pollution Bulletin*, 150: 110792.

CONSTRUCTION AND OPERATIONS PLAN

References – Section 4 – Site Characterization and Assessment of Impacts

- Kaifu, K., T. Akamatsu, and S. Segawa. 2008. Underwater sound detection by cephalopod statocyst. *Fisheries Science*. 74:781-786.
- Kastelein, R.A., 2008. Effects of vibrations on the behaviour of cockles (bivalve molluscs). *Bioacoustics* 17, 74–75.
- Kavanaugh, M.T., J.E. Rheuban, K.M.A. Luis, and S.C. Doney. 2017. Thirty-Three Years of Ocean Benthic Warming Along the U.S. Northeast Continental Shelf and Slope: Patterns, Drivers, and Ecological Consequences. *Journal of Geophysical Research: Oceans*, 122, 9399–9414. <https://doi.org/10.1002/2017JC012953>.
- Kenny, A.J. and H.L. Rees. 1994. The effects of marine gravel extraction on the macrobenthos: Early postdredging recolonization. *Marine Pollution Bulletin* 28: 442–447.
- Kerckhof, F., I. de Mesel, and S. Degraer. 2016. Do wind farms favour introduced hard substrata species? *In* Environmental impacts of offshore wind farms in the Belgian part of the North Sea: Environmental impact monitoring reloaded, pp. 61–75. Ed. by S. Degraer, R. Brabant, B. Rumes, and L. Vigin. Royal Belgian Institute of Natural Sciences, OD Natural Environment, Marine Ecology and Management Section, Oostende, Belgium.
- Kikuchi, R. 2010. Risk formulation for the sonic effects of offshore wind farms on fish in the EU region. *Marine Pollution Bulletin*, 60(2), 172-177. <https://doi.org/10.1016/j.marpolbul.2009.09.023>.
- Kleisner, K.M., M.J. Fogarty, S. McGee, J.A. Hare, S. Moret, C.T. Perretti and V.S. Saba. 2017. Marine species distribution shifts on the US Northeast Continental Shelf under continued ocean warming. *Progress in Oceanography* 153: 24-36.
- Kraus, C. and L. Carter. 2018. Seabed recovery following protective burial of subsea cables - Observations from the continental margin. *Ocean Engineering* 157: 251-261.
- Kreeger, D.A, P.W. Gatenby, Bergstrom. 2018. Restoration Potential of Several Native Species of Bivalve Molluscs for Water Quality Improvement in Mid-Atlantic Watersheds. *Journal of Shellfish Research* 37(5), 1121-1157.
- LaFrance, M., E. Shumchenia, J. King, R. Pockalny, B. Oakley, S. Pratt, and J. Boothroyd. 2010. Benthic Habitat Distribution and Subsurface Geology Selected Sites from the Rhode Island Ocean Special Area Management Study Area. Technical Report 4. 99 pp; Kingston, RI, University of Rhode Island.
- LaFrance Bartley, M., J.W. King, B.A. Oakley, and B.J. Caccioppoli. 2018. Submerged marine habitat mapping at Fire Island National Seashore: A post-hurricane Sandy study. Natural Resource Report NPS/NCBN/NRR—2018/1797. National Park Service, Fort Collins, Colorado.
- Langhamer, O. and D. Wilhelmsson. 2009. Colonization of fish and crabs of wave energy foundations and the effects of manufactured holes – a field experiment. *Marine Environmental Research* 68(4): 151–157.

CONSTRUCTION AND OPERATIONS PLAN

References – Section 4 – Site Characterization and Assessment of Impacts

- Love, M., M. Nishimoto, S. Clark, and A. Bull. 2015. Identical Response of Caged Rock Crabs (Genera *Metacarcinus* and *Cancer*) to Energized and Unenergized Undersea Power Cables in Southern California, USA. *Bulletin of the Southern California Academy of Sciences* 1(114): 9.
- Love, M., M. Nishimoto, S. Clark, and A. Bull. 2016. Renewable Energy in situ Power Cable Observation. Report by University of California Santa Barbara. p. 106.
- Love, M.S., M.M. Nishimoto, S. Clark, M. McCrea, and A.S. Bull. 2017. Assessing potential impacts of energized submarine power cables on crab harvests. *Continental Shelf Research* 151: 23-29.
- Lovell, J.M., M.M. Findlay, R.M. Moate and H.Y. Yan. 2005. The hearing abilities of the prawn *Palaemon serratus*. *Comparative Biochemistry and Physiology Part A: Molecular & Integrative Physiology*. 140(1):89-100.
- Lovell, J.M., R.M. Moate, L. Christiansen, and M.M. Findlay. 2006. The relationship between body size and evoked potentials from the statocysts of the prawn *Palaemon serratus*. *Journal of Experimental Biology*. 209(13):2480-2485.
- Lui, S., J.A. Goff, R.D. Flood, B. Christensen, and J.A. Austin. 2018. Sorted bedforms off Western Long Island, New York, USA: Asymmetrical morphology and twelve-year migration record. *Sedimentology* 65: 2202-2222.
- Maurer, D., R.T. Keck, J.C. Tinsman, W.A. Leathem, C. Wethe, C. Lord, and T. Church. 1986. Vertical migration and mortality of marine benthos in dredged material: a synthesis. *International Revue des Gesamten Hydrobiologie* 71(1): 49–63.
- Maurer, D. and W. Leathem. 1981. Ecological distribution of polychaetous annelids from the New England outer continental shelf, Georges Bank. *Internationale Revue Der Gesamten Hydrobiologie* 66, 505–528.
- Maurer, D., P. Kinner, W. Leathem, and L. Watling. 1976. Benthic faunal assemblages off the Delmarva Peninsula. *Estuarine and Coastal Marine Science* 4, 163–177.
- McMaster, R.L. 1960. Sediments of Narragansett Bay System and Rhode Island Sound, Rhode Island, *Journal of Sedimentary Petrology*, v. 30, n. 2, p. 249-274.
- Miller, J.H., G.R. Potty, K. Hui-Kwan, 2016. Pile-driving pressure and particle velocity at the seabed: quantifying effects on crustaceans and groundfish. In: Popper, A.N., Hawkins, A.D. (Eds.), *The Effects of Noise on AQUATIC Life II*. Springer, New York, NY, pp. 705–712.
- Minerals Management Service (MMS). 2007. Programmatic environmental impact statement for alternative energy development and production and alternate use of facilities on the Outer Continental Shelf – final environmental impact statement. U.S. Dept. of the Interior, Minerals Management Service, Herndon, VA. OCS EIS/EA MMS 2007-046.
- MMS. 2009. Cape Wind Energy Project Final Environmental Impact Statement (FEIS). MMS EIS-EA, OCS Publication No. 2008-040. Accessed September 2019.
<https://www.boem.gov/Renewable-Energy-Program/Studies/Cape-Wind-FEIS.aspx>.

CONSTRUCTION AND OPERATIONS PLAN

References – Section 4 – Site Characterization and Assessment of Impacts

- Mooney, T.A., R.T. Hanlon, J. Christensen-Dalsgaard, P.T. Madsen, D.R. Ketten, and P.E. Nachtigal. 2010. Sound detection by the longfin squid (*Loligo pealeii*) studied with auditory evoked potentials: sensitivity to low-frequency particle motion and not pressure. *Journal of Experimental Biology*. 213(21):3748-3759.
- Morley EL, Jones G, Radford AN. 2014 The importance of invertebrates when considering the impacts of anthropo- genic noise. *Proc. R. Soc. B* 281: 20132683. <http://dx.doi.org/10.1098/rspb.2013.2683>
- Murchy, K. A., Davies, H., Shafer, H., Cox, K., Nikolich, K., and Juanes, F. (2019). "Impacts of noise on the behavior and physiology of marine invertebrates: A meta-analysis," In *Proc. Meet. Acoust. 5ENAL* (Vol. 37, No. 1, p. 040002). *Acoust. Soc. Am.*
- National Marine Fisheries Service (NOAA Fisheries). 2015. Endangered Species Section 7 Consultation: Biological Opinion: Deepwater Wind: Block Island Wind Farm and Transmission System: NER-2015-12248.
- NOAA Fisheries. 2018. Draft Environmental Impact Statement –Regulatory Impact Review Initial Regulatory Flexibility Analysis to Consider Management Measures for the Jonah Crab Fishery in the Exclusive Economic Zone based upon management measures specified in the Interstate Fishery Management Plan for Jonah Crab and Addenda I and II. Gloucester, MA.
- NOAA Fisheries. 2020a. Ocean Quahog. <https://www.fisheries.noaa.gov/species/ocean-quahog>. Accessed June 2020.
- NOAA Fisheries. 2020b. Atlantic Sea Scallop. <https://www.fisheries.noaa.gov/species/atlantic-sea-scallop>. Accessed June 2020.
- NOAA Fisheries. 2020c. Atlantic Surfclam. <https://www.fisheries.noaa.gov/species/atlantic-surfclam>. Accessed June 2020.
- Northeast Fisheries Science Center (NEFSC). 2021: Atlantic Surfclam and Ocean Quahog Survey from 2010-06-15 to 2010-08-15. NOAA National Centers for Environmental Information. <https://www.fisheries.noaa.gov/inport/item/22565>. Accessed May 2021.
- National Park Service. 2020. National Park Service Research Permit and Reporting System, Investigator's Annual Report on Fire Island, New York. Accessed June 2020. <https://irma.nps.gov/RPRS/lar/Profile/373555>
- New York Department of State (NYDOS). 2013. New York Department of State Offshore Atlantic Ocean Study. Report by New York State Department of State.
- New York State Department of Environmental Conservation (NYSDEC). 2021. Restore New York Shellfish. <https://www.dec.ny.gov/outdoor/110939.html>. Accessed March 2021.
- NYSDEC. 2019. New York Seagrass Habitat Map. Retrieved from: <https://www.arcgis.com/home/webmap/viewer.html?webmap=12ba9d56b75d497a84a36f94180bb5ef&extent=-74.6987,39.852,-71.315,41.7603>.

CONSTRUCTION AND OPERATIONS PLAN

References – Section 4 – Site Characterization and Assessment of Impacts

- New York State Energy Research and Development Authority (NYSERDA). 2017a. New York State Offshore Wind Master Plan: Analysis of Multibeam Echo Sounder and Benthic Survey Data. Prepared by Inspire Environmental. 168 pp.
- NYSERDA. 2017b. New York State Offshore Wind Master Plan Analysis of Multibeam Echo Sounder and Benthic Survey Data Final Report Prepared for: New York State Energy Research and Development Authority Prepared by: INSPIRE Environmental Middletown, Rhode Island, NYSERDA Report 17-25a, December 2017. <https://www.nyserda.ny.gov/-/media/Files/Publications/Research/Biomass-Solar-Wind/Master-Plan/17-25a-MBES-and-Benthic-Survey-Data.pdf>
- Normandeau (Normandeau Associates, Inc). 2014. Understanding the Habitat Value and Function of Shoal/Ridge/Trough Complexes to Fish and Fisheries on the Atlantic and Gulf of Mexico Outer Continental Shelf: Draft Literature Synthesis for the U.S. Dept. of the Interior, Bureau of Ocean Energy Management. 116 pp.
- Northeast Ocean Data. 2020. Northeast Ocean Data Viewer. Accessed March 2020. <http://www.northeastoceandata.org/data-explorer/>.
- NYSDOS, GOSR, NOAA, Dewberry. 2020. 2018 Long Island South Shore Estuaries, New York Imagery Acquisition and Benthic Habitat Mapping. Dataset.
- O'Hara, C.J. and R.N. Oldale. 1980. Maps showing geology and shallow structure of eastern Rhode Island Sound and Vineyard Sound, Massachusetts: U.S. Geological Survey Miscellaneous Field Studies Map MF-1186. 41 pp.
- Packard A., H.E. Karlsen, and O. Sand. 1990. Low frequency hearing in cephalopods. *Journal of Comparative Physiology A*. 166:501–505.
- Payne, J. and E.S.R. Funds. 2007. Pilot Study on the Effects of Seismic Air Gun Noise on Lobster (*Homarus americanus*). Environmental Studies Research Funds.
- Petersen J.K. and T. Malm. 2006. Offshore windmill farms: threats to or possibilities for the marine environment. *Ambio* 35: 75–80.
- Poppe, L.J., K.Y. McMullen, S.J. Williams, and V.F. Paskevich, eds. 2014. USGS east-coast sediment analysis: Procedures, database, and GIS data. U.S. Geological Survey Open-File Report 2005-1001.
- Popper, A.N., M. Salmon, and K.W. Horch. 2001. Acoustic detection and communication by decapod crustaceans. *Journal of Comparative Physiology A*. 187(2):83-89.
- Popper, A.N. and A.D. Hawkins. 2018. The importance of particle motion to fishes and invertebrates. *J. Acoust. Soc. Am.* 143(1)
- Reid, R.N., D.J. Radosh, A.B. Frame, and S.A. Fromm. 1991. Benthic macrofauna of the New York Bight, 1979-1989. NOAA Technical Report NMFS-103; 50 p.
- Reubens, J.T., U. Braeckman, J. Vanaverbeke, C. Van Colen, S. Degraer, and M. Vincx. 2013. Aggregation at windmill artificial reefs: CPUE of Atlantic cod (*Gadus morhua*) and pouting (*Trisopterus luscus*) at different habitats in the Belgian part of the North Sea. *Fisheries Research* 139: 28–34.

CONSTRUCTION AND OPERATIONS PLAN

References – Section 4 – Site Characterization and Assessment of Impacts

- Rheuban, J.E., M.T. Kavanaugh, and S.C. Doney. 2017. Implications of future Northwest Atlantic bottom temperatures on the American Lobster (*Homarus Americanus*) fishery. *Journal of Geophysical Research: Oceans*, 122, 9387–9398. <https://doi.org/10.1002/2017JC012949>.
- Rheuban, J.E., S.C. Doney, S.R. Cooley and D.R. Hart. 2018. Projected impacts of future climate change, ocean acidification, and management on the US Atlantic sea scallop (*Placopecten magellanicus*) fishery. *PLoS ONE* 13(9): e0203536 13(9).
- Roach, M., M. Cohen, R. Forster, A.S. Revill, and M. Johnson. 2018. The effects of temporary exclusion of activity due to wind farm construction on a lobster (*Homarus gammarus*) fishery suggests a potential management approach. *ICES Journal of Marine Science* 75(4): 1416-1426.
- Roberts, L., S. Cheesman, T. Breithaupt, and M. Elliott. 2015. Sensitivity of the mussel *Mytilus edulis* to substrate-borne vibration in relation to anthropogenically generated noise. *Marine Ecology Progress Series* 538: 185-195.
- Roberts, L., S. Cheesman, M. Elliott, T. Breithaupt. 2016. Sensitivity of *Pagurus bernhardus* (L.) to substrate-borne vibration and anthropogenic noise. *J. Exp. Mar. Biol. Ecol.* 474, 185–194.
- Roberts, L., H.R. Harding, I. Voellmy, R. Brintjes, S.D. Simpson, A.B. Radford, T. Breithaupt, and M. Elliott. 2017. Exposure of benthic invertebrates to sediment vibration: from laboratory experiments to outdoor simulated pile-driving. *Proc. Meetings Acoust.* 27.
- Roberts, L. and M. Elliott. 2017. Good or bad vibrations? Impacts of anthropogenic vibration on the marine epibenthos. *Science of the Total Environment*, 595: 255–268.
- Roper, C.F.E., M.J. Sweeney, and C.E. Nauen. 1984. *FAO Species Catalogue, Vol. 3 Cephalopods of the world. An annotated and illustrated catalogue of species of interest to fisheries.* *FAO Fisheries Synopsis* 125 (3):1–277.
- Saba, V.S., S.M. Griffies, W.G. Anderson, M. Winton, M.A. Alexander, T.L. Delworth, and R. Zhang. 2016. Enhanced warming of the Northwest Atlantic Ocean under climate change. *Journal of Geophysical Research-Oceans*, 121(1), 118-132.
- Samson, J.E., T.A. Mooney, S.W. Gussekloo and R.T Hanlon. 2014. Graded behavioral responses and habituation to sound in the common cuttlefish *Sepia officinalis*. *Journal of Experimental Biology*. 217(24):4347-4355.
- Schwab, W.C., W.E. Baldwin, J.F. Denny, C.J. Hapke, P.T. Gayes, J.H. List, and J.C. Warner. 2014. Modification of the Quaternary stratigraphic framework of the inner-continental shelf by Holocene marine transgression: An example offshore of Fire Island, New York. *Marine Geology* 355: 346-360.
- Schwab, W.C., W.E. Baldwin, J.C. Warner, J.H. List, J.F. Denny, M. Liste, and I. Safak. 2017. Change in morphology and modern sediment thickness on the inner continental shelf offshore of Fire Island, New York between 2011 and 2014: Analysis of hurricane impact. *Marine Geology* 391: 48-64.

CONSTRUCTION AND OPERATIONS PLAN

References – Section 4 – Site Characterization and Assessment of Impacts

- Scott, K., P. Harsanyi, A.R. Lyndon. 2018. Understanding the effects of electromagnetic field emissions from Marine Renewable Energy Devices (MREDs) on the commercially important edible crab, *Cancer pagurus* (L.). *Mar. Pollut. Bull.* 131, 580–588. <https://doi.org/10.1016/j.marpolbul.2018.04.062>.
- Seaman, W. 2007. Artificial habitats and the restoration of degraded marine ecosystems and fisheries. *Hydrobiologia* 580: 143–155.
- Selden, R.L., R.D. Batt, V.S. Saba, and M.L. Pinsky. 2018. Diversity in thermal affinity among key piscivores buffers impacts of ocean warming on predator-prey interactions. *Global Change Biology*, 24(1): 117-131.
- Siemann, L. and R. Smolowitz. 2017. Southern New England Juvenile Fish Habitat Research Paper. U.S. Department of the Interior, Bureau of Ocean Energy Management, Office of Renewable Energy Programs, Sterling, VA. BOEM 2017- 028. 43 pp.
- Snyder D.B., W.H. Bailey, K. Palmquist, B.R.T. Cotts, and K.R. Olsen. 2019. Evaluation of Potential EMF Effects on Fish Species of Commercial or Recreational Fishing Importance in Southern New England. U.S. Dept. of the Interior, Bureau of Ocean Energy Management, Headquarters, Sterling, VA. OCS Study BOEM 2019-049.
- Solan, M., Hauton, C., Godbold, J. A., Wood, C. L., Leighton, T. G., and White, P. 2016. Anthropogenic sources of underwater sound can modify how sediment-dwelling invertebrates mediate ecosystem properties. *Scientific Reports*, 6: 1–9. Nature Publishing Group. <http://dx.doi.org/10.1038/srep20540>.
- Solé, M., M. Lenoir, M. Durfort, M. López-Bejar, A. Lombarte, and M. André. 2013. Ultrastructural damage of *Loligo vulgaris* and *Illex coindetii* statocysts after low frequency sound exposure. *PLoS ONE* 8(10):e78825.
- Solé, M., P. Sigray, M. Lenoir, M. Van Der Schaar, E Lalander, and M. André. 2017. Offshore exposure experiments on cuttlefish indicate received sound pressure and particle motion levels associated with acoustic trauma. *Scientific reports*. 7:45899.
- Steimle, F.W. 1982. The Benthic Macroinvertebrates of the Block Island Sound. *Estuarine, Coastal and Shelf Science*. 15(1):1-16.
- Stevens, A.M., and C.J. Gobler. 2018. Interactive effects of acidification, hypoxia, and thermal stress on growth, respiration, and survival of four North Atlantic bivalves. *Marine Ecology Progress Series* 604: 143-161.
- Stokesbury, K.D.E. 2012. MA Windfarm Survey, Final Report. S Mast video survey of Western portion of the offshore windfarm area. School of Marine Science and Technology (SMAST), University of Massachusetts Dartmouth.
- Stokesbury, K.D.E. 2014. MA Windfarm Survey, Final Report. School for Marine Science and Technology (SMAST), University of Massachusetts Dartmouth.
- Taormina, B., J. Bald, A. Want, G. Thouzeau, M. Lejart, N. Desroy, and A. Carlier. 2018. A review of potential impacts of submarine power cables on the marine environment: Knowledge gaps, recommendations and future directions. *Renewable & Sustainable Energy Reviews* 96: 380-391.

CONSTRUCTION AND OPERATIONS PLAN

References – Section 4 – Site Characterization and Assessment of Impacts

- Taormina, B., C.D. Poi, A. Agnalt, A. Carlier, N. Desroy, R.H. Escobar-Lux, J. D'eu, F. Freytet, and C.M.F. Durif. 2020. Impact of magnetic fields generated by AC/DC submarine power cables on the behavior of juvenile European lobster (*Homarus gammarus*). *Aquatic Toxicology* 220: 105401.
- Theroux, R. B. and R. L. Wigley. 1998. Quantitative composition and distribution of the macrobenthic invertebrate fauna of the continental shelf ecosystems of the northeastern United States. NOAA Technical Report. NMFS 140. 240 pp.
- Trihamletnews. 2020. Town report card on environmental improvement. Trihamletnews. April 18, 2018. <http://www.trihamletnews.com/trihamletnews/trihamletnews/stories/town-report-card-on-environmental-improvements,685>.
- Turbeville, D.B., and G.A. Marsh. 1982. Benthic Fauna of an Offshore Borrow Area in Broward County, Florida. U.S. Army, Corps of Engineers Coastal Engineering Research Center, Miscellaneous Report No. 82-1.
- Truesdale, C.L., T.M. Dalton, and C.M. McManus. 2019. Fishers' knowledge and perceptions of the emerging southern New England Jonah crab fishery. *North American Journal of Fisheries Management*, 39(5): 951-963.
- U.K. Department for Business Enterprise and Regulatory Reform. 2008. Review of Cabling Techniques and Environmental Effects Applicable to the Offshore Wind Industry. Technical Report 2008.
- United States Geological Survey (USGS). 2020. usSEABED: Coastal and Marine Geology Program. <https://walrus.wr.usgs.gov/usseabed/>. Accessed: March 2020.
- Vella, G., I. Rushforth, E. Mason, A. Hough, R. England, P. Styles, T.J. Holt, and P. Thorne. 2001. Assessment of the effects of noise and vibration from offshore wind farms on marine wildlife. Report to The Department of Trade and Industry.
- Wahle, R.A., L. Dellinger, S. Olszewski, and P. Jekielek. 2015. American lobster nurseries of southern New England receding in the face of climate change. *ICES Journal of Marine Science* 72: i69-i78.
- Warner, J.C., W.C. Schwab, J.H. List, I. Safak, M. Liste, W. Baldin. 2017. Inner-Shelf ocean dynamics and seafloor morphologic changes during Hurricane Sandy. *Continental Shelf Research* 138: 1-18.
- White, M. 2015. They're bringing oysters back to Bellport Bay. *Great Patchogue*. July 22, 2015. <https://patchogue.greaterlongisland.com/2015/07/22/theyre-bringing-oysters-back-to-bellport-bay/>.
- Wilhelmsson D., T. Malm, and M.C. Öhman. 2006. The influence of offshore wind power on demersal fish. *ICES Journal of Marine Science* 63: 775–84.

CONSTRUCTION AND OPERATIONS PLAN

References – Section 4 – Site Characterization and Assessment of Impacts

Woodruff, D.L., J.A. Ward, I.R. Schultz, V.I. Cullinan, and K.E. Marshall. 2012. Effects of electromagnetic fields on fish and invertebrates. Task 2.1.3: Effects on aquatic organisms. Fiscal Year 2011 Progress Report on the Environmental Effects of Marine and Hydrokinetic Energy. Prepared for the U.S. Department of Energy. Richland, Washington: Pacific Northwest National Laboratory. Accessed November 2019.
http://www.pnnl.gov/main/publications/external/technical_reports/PNNL-20813Final.pdf.

5.4.4.3 Finfish and Essential Fish Habitat

AKRF, Inc., AECOM, and A. Popper. 2012. Essential Fish Habitat Assessment for the Tappan Zee Hudson River Crossing Project.

Albert, L., F. Deschamps, A. Jolivet, F. Olivier, L. Chauvaud, and S. Chauvaud. 2020. A current synthesis on the effects of electric and magnetic fields emitted by submarine power cables on invertebrates. *Marine Environmental Research* 159: 104958.
<https://doi.org/doi.org/10.1016/j.marenvres.2020.104958>.

Andrianov, Y., G.R. Broun, O.B. Il'inskii, and V.M. Muraveiko. 1984. Frequency characteristics of skate electroreceptive central neurons responding to electrical and magnetic stimulation. *Neurophysiology* 16.4: 364–369.

Armstrong, J.D., D.C. Hunter, R.J. Fryer, P. Rycroft, and J.E. Orpwood. 2015. Behavioural Responses of Atlantic Salmon to Mains Frequency Magnetic Fields. *Scottish Marine and Freshwater Science* 6:9.

Atlantic States Marine Fisheries Commission (ASMFC). 2019. Atlantic Sturgeon. Accessed May 2020. <http://www.asmfc.org/species/atlantic-sturgeon>.

Atlantic Sturgeon Status Review Team. 2007. Status Review of Atlantic sturgeon (*Acipenser oxyrinchus oxyrinchus*). Report to National Marine Fisheries Service, Northeast Regional Office. February 23, 2007. 174 pp.

Auster, P. and L. Stuart. 1986. Species Profiles: Life Histories and Environmental Requirements of Coastal Fishes and Invertebrates (North Atlantic) Sand Lance. Prepared for U.S. Fish and Wildlife Service National Wetlands Research Center. June.

Becker, A., A.K. Whitfield, P.D. Cowley, J. Järnegren, and T.F. Næsje. 2013. Does boat traffic cause displacement of fish in estuaries? *Marine Pollution Bulletin* 75(1):168–173.

Bergström, L., F. Sundqvist, and U. Bergström. 2013. Effects of an offshore wind farm on temporal and spatial patterns in the demersal fish community. *Marine Ecology Progress Series* 485: 199–210.

Bergström, L., L. Kautsky, T. Malm, R. Rosenberg, M. Wahlberg, N.Å. Capetillo, and D. Wilhelmsson. 2014. Effects of offshore wind farms on marine wildlife – a generalized impact assessment. *Environmental Research Letters* 9(3):1-12.

Berry, W., N. Rubinstein, B. Melzian, and B. Hill. 2003. The Biological Effects of Suspended and Bedded Sediment (SABS) in Aquatic Systems: A Review. Internal U.S. Environmental Protection Agency Report. 20 August 2003. Available online at
<https://www.epa.gov/sites/production/files/2015-10/documents/sediment-appendix1.pdf>.

CONSTRUCTION AND OPERATIONS PLAN

References – Section 4 – Site Characterization and Assessment of Impacts

- Betke, K., M. Schultz-von Glahn, and R. Matuschek, R. 2004. Underwater noise emissions from offshore wind turbines. Proceedings of the Joint Congress CFA/DAGA'04, Strasbourg, France. March 22-24, 2004. Available online: <http://www.conforg.fr/cfadaga2004/cdrom/data/procs/welcome.html>.
- Bohaboy, E., A. Malek, and J. Collie. 2010. Baseline characterization: data sources, methods and results. Appendix A to Chapter 5: Commercial and Recreational Fisheries. Ocean SAMP. Wakefield, RI: Rhode Island Coastal Resources Management Council.
- Breece, M.W., D.A. Fox, K.J. Dunton, M.G. Frisk, A. Jordaan, and M.J. Oliver. 2016. Dynamic seascapes predict the marine occurrence of an endangered species: Atlantic Sturgeon *Acipenser oxyrinchus*. *Methods in Ecology and Evolution*. doi: 10.1111/2041-210X.12532.
- Bureau of Ocean Energy Management (BOEM). 2013. Notice of Availability for the Commercial Wind Lease Issuance and Site Assessment Activities on the Atlantic Outer Continental Shelf Offshore Rhode Island and Massachusetts Environmental Assessment. Federal Register, Vol. 77, Docket No. BOEM-2013-13199.
- BOEM. 2019. Guidelines for Providing Benthic Habitat Survey Information for Renewable Energy Development on the Atlantic Outer Continental Shelf Pursuant to 30 CFR 585. June 2019. Available online: <https://www.boem.gov/sites/default/files/renewable-energy-program/Regulatory-Information/BOEM-Renewable-Benthic-Habitat-Guidelines.pdf>. Last accessed June 2020.
- BOEM. 2020. Hydrodynamic Modeling and Particle Tracking in the U.S. Mid-Atlantic Bight. <https://www.boem.gov/sites/default/files/documents/environment/environmental-studies/NSL-19-04.pdf>. Accessed June 24, 2020.
- Cadrin, S.X., D.R. Zemeckis, M.J. Dean, and J. Cournane. 2020. Applied Markers. In: An Interdisciplinary Review of Atlantic Cod (*Gadus morhua*) Stock Structure in the Western North Atlantic Ocean. R.S. McBride and R.K. Smedbol, eds. NOAA Tech Memo NMFS-NE-XXX. June 2020.
- Cargnelli, L.M., S.J. Griesbach, P.L. Berrien, W.W. Morse, and D.L. Johnson. 1999a. Essential fish habitat source document: Haddock, *Melanogrammus aeglefinus*, Life History and Habitat Characteristics. NOAA Tech Memo NMFS-NE-128. 31 p.
- Cargnelli, L.M., S.J. Griesbach, and W.W. Morse. 1999b. Essential Fish Habitat Source Document: Atlantic Halibut, *Hippoglossus*, Life History and Habitat Characteristics. NOAA Tech Memo NMFS-NE-125.
- Cargnelli, L.M., S.J. Griesbach, D.B. Packer, P.L. Berrien, W.W. Morse, and D.L. Johnson. 1999c. Essential Fish Habitat Source Document: Witch Flounder, *Glyptocephalus cynoglossus*, Life History and Habitat Characteristics. NOAA Tech Memo NMFS-NE-139. 38 p.
- Cargnelli, L.M., S.J. Griesbach, D.B. Packer, P.L. Berrien, D.L. Johnson, and W.W. Morse. 1999d. Essential Fish Habitat Source Document: Pollock, *Pollachius virens*, Life History and Habitat Characteristics. NOAA Tech Memo NMFS-NE-131. 38 p.
- Chang, S., P.L. Berrien, D.L. Johnson, and W.W. Morse. 1999. Essential Fish Habitat Source Document: Windowpane, *Scophthalmus aquosus*, Life History and Habitat Characteristics. NOAA Tech Memo NMFS-NE-137. 40 p.

CONSTRUCTION AND OPERATIONS PLAN

References – Section 4 – Site Characterization and Assessment of Impacts

- Claudet, J. and D. Pelletier. 2004. Marine protected areas and artificial reefs: a review of the interactions between management and scientific studies. *Aquatic Living Resources* 17: 129–138.
- Collette, B.B., and G. Klein-MacPhee, eds. 2002. *Bigelow and Schroeder's fishes of the Gulf of Maine*. 3rd Ed. Washington, DC: Smithsonian Institution Press.
- Collie, J.S., A.D. Wood, and H.P. Jeffries. 2008. Long-term shifts in the Species Composition of a Coastal Fish Community. *Canadian Journal of Fisheries and Aquatic Sciences*. 65:1352-1365.
- Collie, J.S. and J.W. King. 2016. Spatial and Temporal Distributions of Lobsters and Crabs in the Rhode Island Massachusetts Wind Energy Area. OCS Study BOEM 2016-073. Sterling, Virginia: U.S. Dept. of the Interior, Bureau of Ocean Energy Management, Atlantic OCS Region.
- Copping A., N. Sather, L. Hanna, J. Whiting, G. Zydlewski, G. Staines, A. Gill, I. Hutchison, A. O'Hagan, T. Simas, J. Bald, C. Sparling, J. Wood, and E. Masden. 2016. Annex IV 2016 State of the Science Report: Environmental Effects of Marine Renewable Energy Development Around the World.
- Cross, J.N., C.A. Zetlin, P.L. Berrien, D.L. Johnson, and C. McBride. 1999. Essential Fish Habitat Source Document: Butterfish, *Peprilus triacanthus*, Life History and Habitat Characteristics. NOAA Tech Memo NMFS-NE-145. 50 p.
- CSA Ocean Sciences Inc. 2020. Application for incidental harassment authorization for the non-lethal taking of marine mammals: site characterization surveys Lease OCS-A 0486, 0517, 0487, 0500 and Associated Export Cable Routes. Submitted to Orsted. July 2020. 89 pp.
- Curtice, C., J. Cleary, E. Shumchenia, and P.N. Halpin. 2016. Marine-life Data and Analysis Team (MDAT) technical report on the methods and development of marine-life data to support regional ocean planning and management. Prepared for the Marine-life Data and Analysis Team (MDAT). http://seamap.env.duke.edu/models/MDAT/MDATTechnical-Report-v1_1.pdf. Accessed August 4, 2017.
- Dadswell, M. 2006. A Review of the Status of Atlantic Sturgeon in Canada, with Comparisons to Populations in the United States and Europe. *Fisheries*. 31. 218-229. 10.1577/1548-8446(2006)31[218:AROTSO]2.0.CO;2.
- Dean, M., G. DeCelles, D. Zemeckis, and T. Ames. 2020. Early Life History. In: An Interdisciplinary Review of Atlantic Cod (*Gadus morhua*) Stock Structure in the Western North Atlantic Ocean. R.S. McBride and R.K. Smedbol, eds. NOAA Tech Memo NMFS-NE-XXX. June 2020.
- Demarest, C. 2009. Essential Fish Habitat – Atlantic wolffish (*Anarhichas lupus*). Prepared for New England Fishery Management Council. Newburyport Massachusetts.
- DONG Energy, Vattenfall, The Danish Energy Authority, and The Danish Forest and Nature Agency. 2006. Danish Offshore Wind: Key Environmental Issues. November 2006.
- Dunton, K.J., Jordaan, A., McKown, K.A., Conover, D.O. and Frisk, M.G., 2010. Abundance and distribution of Atlantic sturgeon (*Acipenser oxyrinchus*) within the Northwest Atlantic Ocean, determined from five fishery-independent surveys. *Fishery Bulletin*. 108: 450-465.

CONSTRUCTION AND OPERATIONS PLAN

References – Section 4 – Site Characterization and Assessment of Impacts

- Dunton, K.J., D. Chapman, A. Jordaan, K. Feldheim, S.J. O’Leary, K.A. McKown, and M.G. Frisk. 2012. Brief Communications, Genetic mixed-stock analysis of Atlantic sturgeon *Acipenser oxyrinchus* in a heavily exploited marine habitat indicates the need for routine genetic monitoring. *Journal of Fish Biology* 80: 207-217.
- Dunton, K.J., A. Jordaan, D.O. Conover, K.A. McKown, L.A. Bonacci, and M.G. Frisk. 2015. Marine Distribution and Habitat Use of Atlantic Sturgeon in New York Lead to Fisheries Interactions and Bycatch, *Marine and Coastal Fisheries: Dynamics, Management, and Ecosystem Science*. 7:1, 18-32.
- Erickson, D.L., Kahnle, A., Millard, M.J., Mora, E.A., Bryja, M., Higgs, A., Mohler, J., DuFour, M., Kenney, G., Sweka, J. and Pikitch, E.K. 2011. Use of pop-up satellite archival tags to identify oceanic-migratory patterns for adult Atlantic Sturgeon, *Acipenser oxyrinchus* Mitchell, 1815. *Journal of Applied Ichthyology*. 27:356-365.
- Fahay, M., P. Berrien, D. Johnson, and W. Morse. 1999a. Essential Fish Habitat Source Document: Atlantic Cod, *Gadus morhua*, Life History and Habitat Characteristics. NOAA Tech Memo NMFS-NE-124.
- Fahay, M., P. Berrien, D. Johnson, and W. Morse. 1999b. Bluefish, *Pomatomus saltatrix*, Life History and Habitat Characteristics. NOAA Tech Memo NMFS-NE-144.
- Fairchild, E.A. 2017. Indications southern Gulf of Maine Winter Flounder spawn offshore. *Marine and Coastal Fisheries*. Accepted - DOI: 10.1080/19425120.2017.1365786.
- Fisheries Hydroacoustic Working Group. 2008. Agreement in Principle for Interim Criteria for Injury to Fish from Pile Driving Activities.
- Fletcher, D.E., E.El. Dakin, B.A. Porter, and J.C. Avise. 2004. Spawning behavior and genetic parentage in the pirate perch (*Aphredoderus sayanus*), a fish with an enigmatic reproductive morphology. *Copeia*. 2004: 1–10.
- Fortune, I.S. and D.M Paterson. 2020. Ecological best practice in decommissioning: a review of scientific research. *ICES Journal of Marine Science*. 77(3): 1079109. <https://doi.org/10.1093/icesjms/fsy130>.
- Germano, J., J. Parker, and J. Charles. 1994. Monitoring cruise at the Massachusetts Bay Disposal Site, August 1990. DAMOS Contribution No. 92. U.S. Army Corps of Engineers, New England Division. Waltham, Massachusetts.
- Gerry, S.P. and A.J. Scott. 2010. Shark scavenging behavior in the presence of competition. *Current Zoology* 56:100-108.
- Gill, A.B., M. Bartlett, and F. Thomsen. 2012. Potential interactions between diadromous fishes of U.K. conservation importance and the electromagnetic fields and subsea noise from marine renewable energy developments. *Journal of Fish Biology*. 81, 664–695.
- Glarou, M., M. Zrust, and J.C. Svendsen. 2020. Using artificial-reef knowledge to enhance the ecological function of offshore wind turbine foundations: implications for fish abundance and diversity. *Journal of Marine Science and Engineering*, 8: 332; doi:10.3390/jmse8050332.

CONSTRUCTION AND OPERATIONS PLAN

References – Section 4 – Site Characterization and Assessment of Impacts

- Greater Atlantic Region Fisheries Office (GARFO). 2019. GARFO Acoustic Tool: Analyzing the effects of pile driving on ESA-listed species in the Greater Atlantic Region. Accessed August 2020.
<http://www.greateratlantic.fisheries.noaa.gov/protected/section7/guidance/consultation/index.html>.
- Guarinello, M., D. Carey, and L. Brown Read. 2017. Year 1 Report for 2016 Summer Post-Construction Surveys to Characterize Potential Impacts and Response of Hard Bottom Habitats to Anchor Placement at the Block Island Wind Farm (BIWF). INSPIRE Environmental prepared for Deepwater Wind Block Island LLC. May.
- Guida, V., A. Drohan, H. Welch, J. McHenry, D. Johnson, V. Kentner, J. Brink, D. Timmons, and E. Estela-Gomez. 2017. Habitat Mapping and Assessment of Northeast Wind Energy Areas. Sterling, VA: US Department of the Interior, Bureau of Ocean Energy Management. OCS Study BOEM 2017-088. 312 p.
- Handegard, N.O. and D. Tjøstheim. 2005. When fish meet a trawling vessel: Examining the behaviour of gadoids using a free-floating buoy and acoustic split-beam tracking. *Canadian Journal of Fisheries and Aquatic Sciences*. 62(10):2409-2422.
- Hare, J.A., W.E. Morrison, M.W. Nelson, M.M. Stachura, E.J. Teeters, R.B. Griffis, and C.A. Griswold. 2016. A Vulnerability Assessment of Fish and Invertebrates to Climate Change on the Northeast US Continental Shelf. *PLoS One* 11(2), 30.
- Hasbrouck, E.C., J. Scotti, J. Stent, and K. Gerbino. 2011. Rhode Island commercial fishing and seafood industries: The development of an industry profile. Prepared for: Commercial Fisheries Research Foundation. Kingston, Rhode Island.
- Hawkins, A.D., L. Roberts, and S. Cheesman. 2014. Responses of free-living coastal pelagic fish to impulsive sounds. *Acoustical Society of America* 3101-3116. Accessed July 2020.
<http://dx.doi.org/10.1121/1.4870697>.
- Hawkins, A.D., C. Johnson, and A.N. Popper. 2020. How to set sound exposure criteria for fishes. *The Journal of the Acoustical Society of America* 147: 1762-1777.
- Hernandez, K.M., D. Risch, D.M. Cholewiak, M.J. Dean, L.T. Hatch, W.S. Hoffman, A.N. Rice, D. Zemeckis, and S.M. Van Parijs. 2013. Acoustic monitoring of Atlantic cod (*Gadus morhua*) in Massachusetts Bay: implications for management and conservation. *ICES Journal of Marine Science*. 70: 628-635.
- Hirsch, N.D. L.H. DiSalvo, and R. Peddicord. 1978. Effects of dredging and disposal on aquatic organisms. Technical Report DS-78-5. U.S. Army Engineer Waterways Experiment Station. Vicksburg, MS. NTIS No. AD A058 989.
- Ingram, E.C., Cerrato, R.M., Dunton, K.J. and Frisk, M.G. 2019. Endangered Atlantic Sturgeon in the New York Wind Energy Area: implications of future development in an offshore wind energy site. *Scientific reports*. 9:1-13.
- INSPIRE Environmental. 2018a. Block Island Wind Farm Demersal Fish Trawl Survey: Annual Report October 2016 through September 2017. INSPIRE Environmental.

CONSTRUCTION AND OPERATIONS PLAN

References – Section 4 – Site Characterization and Assessment of Impacts

- INSPIRE Environmental. 2018b. Ichthyoplankton and Zooplankton Assessment – Jet Plow Entrainment Report. Prepared for CH2M and Deepwater Wind South Fork, LLC. Submitted April 2018.
- Johnson, D., W. Morse, P. Berrien, and J. Vitaliano. 1999a. Essential Fish Habitat Source Document: Yellowtail Flounder, *Limanda ferruginea*, Life History and Habitat Characteristics. NOAA Tech Memo NMFS-NE-140.
- Johnson, D., P. Berrien, W. Morse, and J. Vitaliano, Joseph. 1999b. Essential Fish Habitat Source Document: American Plaice, *Hippoglossoides platessoides*, Life History and Habitat Characteristics. NOAA Tech Memo NMFS-NE-123.
- Kavet, R., M.T. Wyman, and A.P. Klimley. 2016. Modeling Magnetic Fields from a DC Power Cable Buried Beneath San Francisco Bay Based on Empirical Measurements. PLoS ONE 11 (2): e0148543.
- Kempster, R.M., N.S. Hart, and S.P. Collin. 2013. Survival of the stillest: predator avoidance in shark embryos. PLoS One 8(1):e52551.
- Kenny, A.J. and H.L. Rees. 1994. The effects of marine gravel extraction on the macrobenthos: Early postdredging recolonization. Marine Pollution Bulletin 28: 442–447.
- Kikuchi, R. 2010. Acoustic pathways for underwater noise from an offshore wind turbine under operation: Risk formulation for the sonic effects of offshore wind farms on fish in the EU region. Marine Pollution Bulletin 60(2): 172–177.
- Kleisner, K.M., M.J. Fogarty, S. McGee, J.A. Hare, S. Moret, C.T. Perretti, and V.S. Saba. 2017. Marine species distribution shifts on the US Northeast Continental Shelf under continued ocean warming. Progress in Oceanography 153: 24-36.
- Knickel, C. 2017. Sandbar Shark. Prepared for the Florida Museum of Natural History. Accessed June 2020. <https://www.floridamuseum.ufl.edu/discover-fish/species-profiles/carcharhinus-plumbeus/>.
- Kovach, A.I., T.S. Breton, D.L. Berlinsky, L. Maceda, and I. Wirgin. 2010. Fine-scale spatial and temporal genetic structure of Atlantic Cod off the Atlantic coast of the USA. Marine Ecology Progress Series. 410:177–195.
- Kuffner, A. 2018. Front line of climate change: Black sea bass surge off R.I., new article. Providence Journal, July 15, 2018. Accessed January 2020. <https://www.providencejournal.com/news/20180715/front-line-of-climate-change-black-sea-bass-surge-off-ri>.
- Kuhnz, L.A., J.P. Barry, K. Buck, C. Lovera, and P.J. Whaling. 2015. Potential impacts of the Monterey Accelerated Research System (MARS) cable on the seabed and benthic faunal assemblages. MARS Biological Survey Report, Monterey Bay Aquarium Research Institute.
- Langan, J.A., M.C. McManus, D.R. Zemeckis, and J.S. Collie. 2020. Abundance and distribution of Atlantic cod (*Gadus morhua*) in a warming southern New England. Fishery Bulletin, 118: 145-158.

CONSTRUCTION AND OPERATIONS PLAN

References – Section 4 – Site Characterization and Assessment of Impacts

- Langhamer, O. and D. Wilhelmsson. 2009. Colonization of fish and crabs of wave energy foundations and the effects of manufactured holes – a field experiment. *Marine Environmental Research* 68(4): 151–157.
- Leonhard, S.B., C. Stenberg, and J.G. Støttrup, eds. 2011. Effect of the Horns Rev 1 Offshore Wind Farm on Fish Communities: Follow-up Seven Years after Construction. Danish Energy Authority.
- Lindeboom, H.J., H.J. Kouwenhoven, M.J.N. Bergman, S. Bouma, S. Brasseur, R. Daan, R.C. Fijn, D. de Haan, S. Dirksen, R. van Hal, R. Hille Ris Lambers, R. ter Hofstede, K.L. Krijgsveld, M. Leopold, and M. Scheidat. 2011. Short-term ecological effects of an offshore wind farm in the Dutch coastal zone; a compilation. *Environmental Research Letters* 6: 1–13.
- Lipsky, A. 2014. Addressing Interactions between Offshore Wind Energy Development and Fisheries in the Northeastern U.S. SeaPlan. Lecture.
- Love, M.S., M.M. Nishimoto, S. Clark, and A.S. Bull. 2016. Renewable Energy in situ Power Cable Observation. OCS Study 2016-008. Camarillo, CA: U.S. Department of the Interior, Bureau of Ocean Energy Management, Pacific OCS Region.
- Malek, A. 2015. An Investigation of the Fisheries Ecosystem Dynamics in Rhode Island's Nearshore Waters. URI Dissertation, Open Access Dissertations. Paper 352. p. 215.
- Malek, A.J., J. Collie, M. LaFrance, and J. King. 2010. Fisheries ecology and benthic habitat in Rhode Island and Block Island Sounds. Technical Report #14 of the Ocean Special Area Management Plan. Rhode Island Coastal Resources Management Council, Wakefield, RI.
- Malek, A., J.S. Collie, and J. Gartland. 2014. Fine scale spatial patterns in the demersal fish and invertebrate community in a Northwest Atlantic ecosystem. *Estuarine, Coastal and Shelf Science*. Vol. 147. pp. 1-10.
- Malek, A., J.S. Collie, and D.L. Taylor. 2016. Trophic structure of a coastal fish community determined with diet and stable isotope analyses: coastal fish community trophic structure. *Journal of Fish Biology*. Vol. 89, Issue 3. July.
- Massachusetts Department of Energy and Environmental Affairs. 2017. Atlantic Bonito. Accessed August 2020. <https://www.mass.gov/service-details/learn-about-atlantic-bonito>.
- Massachusetts Executive Office of Energy and Environmental Affairs (MA EOEEA). 2015. Massachusetts Ocean Management Plan, Volume 1 Management and Administration. Prepared for: Massachusetts Office of Energy and Environmental Affairs.
- McBride, R.S., M.P. Fahay, and K.W. Able. 2002. Larval and settlement periods of the northern searobin (*Prionotus carolinus*) and the striped searobin (*P. evolans*). *Fisheries Bulletin*. Vol. 100. pp. 63–73. Accessed June 22, 2020. <http://aquaticcommons.org/15190/1/mcb.pdf>.
- McBride, R.S., M.K. Tweedie, and K. Oliveira. 2018. Reproduction, first-year growth, and expansion of spawning and nursery grounds of black sea bass (*Centropristis striata*) into a warming Gulf of Maine. *Fishery Bulletin* 116(3-4): 323–336.

CONSTRUCTION AND OPERATIONS PLAN

References – Section 4 – Site Characterization and Assessment of Impacts

- McGregor, F., A.J. Richardson, A.J. Armstrong, A.O. Armstrong, and C.L. Dudgeon. 2019. Rapid would healing in a reef manta ray masks the extent of vessel strike. *PLoS ONE* 14(12): e0225681.
- McGuire, C.H., M.J. Dean, W.S. Hoffman, S.X. Cadrin, and D. Zemeckis. 2016. Ecosystem Studies of Atlantic Cod Spawning Aggregations in Relation to Fisheries Interactions Using Novel Active and Passive Acoustic Approaches. Prepared for: NOAA National Marine Fisheries Service, Saltonstall Kennedy Grant Program.
- McManus, M.C., J.A. Hare, D.E. Richardson, and J.S. Collie. 2018. Tracking shifts in Atlantic mackerel (*Scomber scombrus*) larval habitat suitability on the Northeast US Continental Shelf. *Fisheries Oceanography* 27(1): 49–62.
- Mid-Atlantic Fishery Management Council (MAFMC). 2016. Regional Use of the Habitat Area of Particular Concern (HAPC) Designation. May 2016.
- MAFMC. 2017. Unmanaged Forage Omnibus Amendment: Amendment 20 to the Summer Flounder, Scup, and Black Sea Bass Fishery Management Plan, Amendment 18 to the Mackerel, Squid, and Butterfish Fishery Management Plan, Amendment 19 to the Surf Clam and Ocean Quahog Fishery Management Plan, Amendment 6 to the Bluefish Fishery Management Plan, Amendment 5 to the Tilefish Fishery Management Plan, Amendment 5 to the Spiny Dogfish Fishery Management Plan, Including an Environmental Assessment, Regulatory Impact Review, and Regulatory Flexibility Act Analysis. March 2017.
- Minerals Management Service (MMS). 2007. Programmatic environmental impact statement for alternative energy development and production and alternate use of facilities on the Outer Continental Shelf – final environmental impact statement. U.S. Dept. of the Interior, Minerals Management Service, Herndon, VA. OCS EIS/EA MMS 2007-046.
- MMS. 2009. Cape Wind Energy Project Final Environmental Impact Statement (FEIS). MMS EIS-EA, OCS Publication No. 2008-040. Accessed September 2019.
<https://www.boem.gov/Renewable-Energy-Program/Studies/Cape-Wind-FEIS.aspx>.
- Morse, W., D. Johnson, P. Berrien, and S. Wilk. 1999. Essential Fish Habitat Source Document: Silver Hake, *Merluccius bilinearis*, Life History and Habitat Characteristics. NOAA Tech Memo NMFS-NE-135.
- Morton, T. 1989. Bay Anchovy Species Profile: Life Histories and Environmental Requirements of Coastal Fishes and Invertebrates (Mid-Atlantic). U.S. Department of the Interior Fish and Wildlife Service and U.S. Army Corps of Engineers Coastal Ecology Group Waterways Experiment Station. Accessed June 22, 2020.
<https://www.nrc.gov/docs/ML0720/ML072060555.pdf>.
- Murdy, E.O., R.S. Birdsong, and J.A. Musick. 1997. *Fishes of the Chesapeake Bay*. Washington, D.C.: Smithsonian Institution Press.
- National Marine Fisheries Service (NOAA Fisheries). 2013a. Formal Endangered Species Act Section 7 Consultation – Final Biological Opinion: Commercial Wind Lease Issuance and Related Activities Authorized by the Bureau of Ocean Energy Management (BOEM) and the U.S. Army Corps of Engineers (USACE) within Designated Wind Energy Areas (WEA) on

CONSTRUCTION AND OPERATIONS PLAN

References – Section 4 – Site Characterization and Assessment of Impacts

- the Outer Continental Shelf off Rhode Island, Massachusetts, New York and New Jersey. National Oceanic and Atmospheric Administration, National Marine Fisheries Service (NMFS). NER-2012-9211.
- NOAA Fisheries. 2013b. Northeast Region. Endangered Species Act Section 7 Consultation, Biological Opinion. Tappan Zee Bridge Replacement Project. April 10, 2013. PCTS: NER-2013-9592.
- NOAA Fisheries. 2017a. 50 CFR Part 226 [Docket No. 150818735–7452–02] RIN 0648–BF28 Endangered and Threatened Species; Designation of Critical Habitat for the Endangered New York Bight, Chesapeake Bay, Carolina and South Atlantic Distinct Population Segments of Atlantic Sturgeon and the Threatened Gulf of Maine Distinct Population Segment of Atlantic Sturgeon.
- NOAA Fisheries. 2017b. Amendment 10 to the 2006 Consolidated Atlantic Highly Migratory Species Fishery Management Plan: Essential Fish Habitat. Office of Sustainable Fisheries, Atlantic Highly Migratory Species Management Division. 442 p. Accessed June 2020. https://www.habitat.noaa.gov/application/efhinventory/docs/a10_hms_efh.pdf.
- NOAA Fisheries. 2018. What are pelagic fish? <https://oceanservice.noaa.gov/facts/pelagic.html>. Accessed September 2019.
- NOAA Fisheries. 2019. Atlantic sturgeon. <https://www.fisheries.noaa.gov/species/atlantic-sturgeon>. Accessed September 2019.
- NOAA Fisheries. 2020a. Essential Fish (EFH) Habitat Mapper. <https://www.fisheries.noaa.gov/resource/map/essential-fish-habitat-mapper>. Accessed June 2020.
- National Oceanic and Atmospheric Administration (NOAA). 2009. Consolidated Atlantic Highly Migratory Species Fishery Management Plan, Amendment 1, Chapter 5.
- NOAA. 2015. Resource Survey Report, Catch Summary, Spring Bottom Trawl Survey, Cape Hatteras – Gulf of Maine. Northeast Fisheries Science Center (NEFSC), Ecosystems Surveys Branch.
- NOAA. 2016. Cobia: *Rachycentron canadum*. Status Review Report: Common Thresher (*Alopias vulpinus*) and Bigeye Thresher (*Alopias superciliosus*) Sharks. National Marine Fisheries Service.
- NOAA. 2020a. Essential Fish Habitat Description Monkfish (*Lophius americanus*). <https://www.greateratlantic.fisheries.noaa.gov/hcd/monkfish.pdf>. Accessed June 2020.
- NOAA. 2020b. Essential Fish Habitat Description Whiting (*Merluccius bilinearis*). <https://www.greateratlantic.fisheries.noaa.gov/hcd/whiting.pdf>. Accessed June 2020.
- Neo, Y.Y., E. Ufkes, R.A. Kastelein, H.V. Winter, C. ten Cate, and H. Slabbekoorn. 2015. Impulsive sounds change European seabass swimming patterns: Influence of pulse repetition interval. Marine Pollution Bulletin. <http://dx.doi.org/10.1016/j.marpolbul.2015.06.027>. Accessed July 2020.

CONSTRUCTION AND OPERATIONS PLAN

References – Section 4 – Site Characterization and Assessment of Impacts

- New England Fishery Management Council (NEFMC). 2017. Omnibus Essential Fish Habitat Amendment 2. Volume 2: EFH and HAPC Designation Alternatives and Environmental Impacts. https://www.habitat.noaa.gov/protection/efh/efhmapper/oa2_efh_hapc.pdf. Accessed June 2020.
- New York State Department of Environmental Conservation (NYSDEC). 2008. Coastal Fish & Wildlife Habitat Assessment Form – Carmans River. December 15. Accessed July 2020. https://www.dos.ny.gov/opd/programs/consistency/Habitats/LongIsland/Carmans_River.pdf.
- NYSDEC. 2020. Fish Atlas Maps of New York, Common Carp. <https://www.dec.ny.gov/animals/94433.html#:~:text=Cyprinus%20carpio,present%20in%20higher%20elevation%20lakes>. Accessed July 2020.
- Nightingale, B., T. Longcore, and C.A. Simenstad. 2006. Artificial night lighting and fishes. In: Ecological Consequences of Artificial Night Lighting. C. Rich and T. Longcore, eds. Washington, DC: Island Press. pp. 257–276.
- Northeast Fisheries Science Center (NEFSC). 2004. *Essential Fish Habitat Source Document Update Memo: Offshore Hake, Merluccius albidus, Life History and Habitat Characteristics*. NOAA/NMFS/NEFSC. James J. Howard Marine Sciences Laboratory, Highlands, NJ.
- NEFSC. 2017. EFH Source Documents: Life History and Habitat Characteristics. File modified June 28, 2017. <http://www.nefsc.noaa.gov/nefsc/habitat/efh>. Accessed June 2020.
- NEFSC. 2020. Operational assessment of the black sea bass, scup, bluefish, and monkfish stocks, updated through 2018. NEFSC Ref Doc 20-01; 160 p. Available from: <http://www.nefsc.noaa.gov/publications/>.
- NEFSC. 2021. Ecology of the Northeast US Continental Shelf: Zooplankton. <https://apps-nefsc.fisheries.noaa.gov/nefsc/ecosystem-ecology/zooplankton.html>. Accessed: April 29, 2021.
- Northeast Ocean Data. 2017. Data Explorer. <http://www.northeastoceanandata.org/data-explorer/>. Accessed June 2020.
- Nye, J.A., J.S. Link, J.A. Hare, and W.J. Overholtz. 2009. Changing spatial distribution of fish stocks in relation to climate and population size on the Northeast United States continental shelf. *Marine Ecology Progress Series* 393: 111–129.
- O’Leary, S.J., K.J. Dunton, T.L. King, M.G. Frisk, and D. D. Chapman. 2014. Genetic diversity and effective size of Atlantic sturgeon, *Acipenser oxyrinchus* river spawning populations estimated from the microsatellite genotypes of marine-captured juveniles. *Conservation Genetics* 15: 1173-1181.
- Orpwood, J.E., R.J. Fryer, P. Rycroft, and J.D. Armstrong. 2015. Effects of AC Magnetic Fields (MFs) on Swimming Activity in European Eels *Anguilla*. *Scottish Marine and Freshwater Science* 6:8.
- Orr, M. 2016. The potential impacts of submarine power cables on benthic elasmobranchs. Doctoral Dissertation, The University of Auckland, New Zealand.

CONSTRUCTION AND OPERATIONS PLAN

References – Section 4 – Site Characterization and Assessment of Impacts

- Orr, T.L., S. Herz, and D. Oakley. 2013. Evaluation of Lighting Schemes for Offshore Wind Facilities and Impacts to Local Environments. OCS Study. BOEM 2013-0116.
- Packer, D.B., S.J. Griesbach, P.L. Berrien, C.A. Zetlin, D.L. Johnson, and W.W. Morse. 1999. Essential Fish Habitat Source Document: Summer Flounder, *Paralichthys dentatus*, Life History and Habitat Characteristics. NOAA Tech Memo NMFS-NE-151. 98 p.
- Packer D.B., C.A. Zetlin, and J.J. Vitaliano. 2003a. Essential Fish Habitat Source Document: Barndoor skate, *Dipturus laevis*, Life History and Habitat Characteristics. NOAA Tech Memo NMFS NE 173; 23 p.
- Packer, D.B., C.A. Zetlin, and J.J. Vitaliano. 2003b. Essential Fish Habitat Source Document: Little Skate, *Leucoraja erinacea*, Life History and Habitat Characteristics. NOAA Tech Memo NMFS-NE-175. 76 p.
- Packer, D.B., C.A. Zetlin, and J.J. Vitaliano. 2003c. Essential Fish Habitat Source Document: Winter Skate, *Leucoraja ocellata*, Life History and Habitat Characteristics. NOAA Tech Memo NMFS-NE-179. 68 p.
- Parker, N.C. and B.A. Simco. 1975. Activity patterns, feeding and behavior of the Pirate Perch, *Aphredoderus sayanus*. Copeia. 1975: 572–574.
- Pereira, J.J., R. Goldberg, J.J. Ziskowski, P.L. Berrien, W.W. Morse, and D.L. Johnson. 1999. Essential Fish Habitat Source Document: Winter Flounder, *Pseudopleuronectes americanus*, Life History and Habitat Characteristics. NOAA Tech Memo NMFS-NE-138. 48 p.
- Petersen J.K. and T. Malm. 2006. Offshore windmill farms: threats to or possibilities for the marine environment. *Ambio* 35: 75–80.
- Petruny-Parker, M., A. Malek, M. Long, D. Spencer, and F. Mattera. 2015. Identifying Information Needs and Approaches for Assessing Potential Impacts of Offshore Wind Farm Development on Fisheries Resources in the Northeast Region. Sterling. Prepared for the U.S. Department of the Interior Bureau of Ocean Energy Management.
- Phipps, G. 2001. Signals maintenance shapes salmon solution. Northwest Region Bulletin. p. 2.
- Pineda, J., J.A. Hare, and S. Sponaugle. 2007. Larval Transport and Dispersal in the Coastal Ocean and Consequences for Population Connectivity. *Oceanography* 20(3): 22–39.
- Pinsky, M.L., B. Worm, M.J. Fogarty, J.L. Sarmiento, and S.A. Levin. 2013. Marine Taxa Track Local Climate Velocities. *Science* 341(6151): 1239–1242.
- Popper, A.N., A.D. Hawkins, R.R. Fay, D. Mann, S. Bartol, T. Carlson, S. Coombs, W.T. Ellison, R. Gentry, M.B. Halvorsen, and S. Løkkeborg. 2014. Sound Exposure Guidelines for Fishes and Sea Turtles. A Technical Report prepared by ANSI-Accredited Standards Committee S3/SC1 and registered with ANSI. ASA S3/SC1. 4 TR-2014.
- Reid, R.N., L.M. Cargnelli, S.J. Griesbach, D.B. Packer, D.L. Johnson, C.A. Zetlin, W.W. Morse, and P.L. Berrien. 1999. Essential Fish Habitat Source Document: Atlantic herring, *Clupea harengus*, Life History and Habitat Characteristics. NOAA Tech Memo NMFS NE 126.

CONSTRUCTION AND OPERATIONS PLAN

References – Section 4 – Site Characterization and Assessment of Impacts

- Reubens, J.T., U. Braeckman, J. Vanaverbeke, C. Van Colen, S. Degraer, and M. Vincx. 2013. Aggregation at windmill artificial reefs: CPUE of Atlantic cod (*Gadus morhua*) and pouting (*Trisopterus luscus*) at different habitats in the Belgian part of the North Sea. *Fisheries Research* 139: 28–34.
- Rhode Island Coastal Resources Management Council (RI CRMC). 2010. Rhode Island Ocean Special Area Management Plan. Adopted by the RI CRMC on October 19, 2010. <http://seagrant.gso.uri.edu/oceansamp/documents.html>.
- Rhode Island Department of Environmental Management (RIDEM). 2019. Species list for demersal trawl survey in Block Island Sound, Rhode Island Sound, and Narragansett Bay 2012-2018.
- Richardson, N.E., J.D. McCleave, and E.H. Albert. 1976. Effect of extremely low frequency electric and magnetic fields on locomotor activity rhythms of Atlantic salmon (*Salmo salar*) and American eels (*Anguilla rostrata*). *Environmental Pollution* 10(1): 65–76.
- Richardson, W.J., C.R. Greene, C.I. Malme, and D.H. Thomson. 1995. *Marine Mammals and Noise*. San Diego, California: Academic Press.
- Rooker, J., J. Bremer, B. Block, H. Dewar, and G. De Metrio. 2007. *Life History and Stock Structure of Atlantic Bluefin Tuna (Thunnus thynnus)*. *Reviews in Fisheries Science*, vol. 15. December.
- Rowe, S. and J.A. Hutchings. 2004. The function of sound production by Atlantic cod as inferred from patterns of variation in drumming muscle mass. *Can. J. Zool.* 82:1391–1398.
- Saba, V.S., S.M. Griffies, W.G. Anderson, M. Winton, M.A. Alexander, T.L. Delworth, and R. Zhang. 2016. Enhanced warming of the Northwest Atlantic Ocean under climate change. *Journal of Geophysical Research-Oceans*, 121(1), 118-132.
- Sarà, G., J.M. Dean, D.D'Amato, G. Buscaino, A. Oliveri, S. Genovese, S. Ferro, G. Buffa, M. Lo Martire, and S. Mazzola. 2007. Effect of boat noise on the behaviour of bluefin tuna *Thunnus thynnus* in the Mediterranean Sea. *Marine Ecology Progress Series* 331: 243–253.
- Scotti, J., J. Stent, and K. Gerbino. 2010. Final Report: New York Commercial Fisherman Ocean Use Mapping. Prepared for Cornell Cooperative Extension Marine Program.
- Seaman, W. 2007. Artificial habitats and the restoration of degraded marine ecosystems and fisheries. *Hydrobiologia* 580: 143–155.
- Secor, D.H., et al. 2000. Dispersal and growth of yearling Atlantic sturgeon, *Acipenser oxyrinchus*, released into Chesapeake Bay(*). *Fishery Bulletin*, vol. 98, no. 4, 2000, p. 800. Gale Academic OneFile, Accessed 23 June 2020.
- Selden, R.L., R.D. Batt, V.S. Saba, and M.L. Pinsky. 2018. Diversity in thermal affinity among key piscivores buffers impacts of ocean warming on predator-prey interactions. *Global Change Biology*, 24(1), 117-131.
- Sherwood, J., S. Chidgey, P. Crockett, D. Gwyther, P. Ho, S. Stewart, D. Strong, B. Whitely, and A. Williams. 2016. Installation and operational effects of a HVDC submarine cable in a continental shelf setting: Bass Strait, Australia. *Journal of Ocean Engineering and Science* 1: 337-353.

CONSTRUCTION AND OPERATIONS PLAN

References – Section 4 – Site Characterization and Assessment of Impacts

- Siceloff, L., and H. Howell. 2013. Fine-scale temporal and spatial distributions of Atlantic Cod (*Gadus morhua*) on a western Gulf of Maine spawning ground. *Fisheries Research*. Vol. 141. pp. 31–43.
- Siemann, L., and R. Smolowitz. 2017. Southern New England Juvenile Fish Habitat Research Paper. Sterling, Virginia: U.S. Department of the Interior, Bureau of Ocean Energy Management, Office of Renewable Energy Programs, Virginia. BOEM 2017-028. p.43.
- Slabbekoorn, H., J. Dalen, D. Haan, H.V. Winter, C. Radford, M.A. Ainslie, K.D. Heaney, T. Kooten, L. Thomas, and J. Harwood. 2019. Population-level consequences of seismic surveys on fishes: An interdisciplinary challenge. *Fish and Fisheries* 20:653-685.
- Snyder D.B., W.H. Bailey, K. Palmquist, B.R.T. Cotts, and K.R. Olsen. 2019. Evaluation of Potential EMF Effects on Fish Species of Commercial or Recreational Fishing Importance in Southern New England. U.S. Dept. of the Interior, Bureau of Ocean Energy Management, Headquarters, Sterling, VA. OCS Study BOEM 2019-049.
- South Atlantic Fishery Management Council. 2003. Fishery Management Plan for the Dolphin and Wahoo Fishery of the Atlantic Including a Final Environmental Impact Statement, Regulatory Impact Review, Initial Regulatory Flexibility Analysis, and Social Impact Assessment/Fishery Impact Statement.
- Stanley, J.A., Van Parijs, S.M. and L.T. Hatch. 2017. Underwater sound from vessel traffic reduces the effective communication range in Atlantic cod and haddock. *Sci Rep* 7:14633. <https://doi.org/10.1038/s41598-017-14743-9>.
- Steimle, F.W., C.A. Zetlin, P.L. Berrien, and S. Chang. 1999a. Essential Fish Habitat Source Document: Black Sea Bass, *Centropristis striata*, Life History and Habitat Characteristics. NOAA Tech Memo NMFS-NE-143. 50 p.
- Steimle, F.W., W.W. Morse, P.L. Berrien, D.L. Johnson, and C.A. Zetlin. 1999b. Essential Fish Habitat Source Document: Ocean pout, *Macrozoarces americanus*, Life History and Habitat Characteristics. NOAA Tech Memo NMFS-NE-129; 26 p.
- Steimle, F.W., W.W. Morse, P.L. Berrien, and D.L. Johnson. 1999c. Essential Fish Habitat Source Document: Red Hake, *Urophycis chuss*, Life History and Habitat Characteristics. NOAA Tech Memo NFMS-NE-133. 42 p.
- Steimle, F., C. Zetlin, P. Berrien, D. Johnson, and S. Chang. 1999d. Essential Fish Habitat Source Document: Scup, *Stenotomus chrysops*, Life History and Habitat Characteristics. NOAA Tech Memo NMFS-NE-149.
- Steimle, F. and P. Shaheen. 1999e. Essential Fish Habitat Source Document: Tautog, *Tautoga oniti*, Life History and Habitat Requirements. NOAA Tech Memo NMFS-NE-118.
- Stein, A.B., K.D. Friedland, and M. Sutherland. 2004. Atlantic sturgeon marine bycatch and mortality on the continental shelf of the Northeast United States. *North American Journal of Fisheries Management*. Vol. 24, Issue 1. pp. 171-183.
- Studholme, A., D. Packer, P. Berrien, D. Johnson, and C. Zetlin. 1999. Essential Fish Habitat Source Document: Atlantic Mackerel, *Scomber scombrus*, Life History and Habitat Characteristics. NOAA Tech Memo NMFS-NE-141.

CONSTRUCTION AND OPERATIONS PLAN

References – Section 4 – Site Characterization and Assessment of Impacts

- Thomsen, F., K. Lüdemann, R. Kafemann, and W. Piper. 2006. Effects of offshore wind farm noise on marine mammals and fish, biota. Hamburg, Germany on behalf of COWRIE Ltd.
- U.S. Fish and Wildlife Service (USFWS). 1991. Northeast Coastal Areas Study: Significant Coastal Habitats of Southern New England and Portions of Long Island, New York. August 1991.
- USFWS. 2020a. River Herring: Alewife and Blueback Herring. Fish and Aquatic Conservation. <https://www.fws.gov/fisheries/fishmigration/alewife.html>. Accessed June 22, 2020.
- USFWS. 2020b. Freshwater Fish of America, Black crappie. https://www.fws.gov/fisheries/freshwater-fish-of-america/black_crappie.html. Accessed July 2020.
- USFWS. 2020c. Freshwater Fish of America, Brook trout. https://www.fws.gov/fisheries/freshwater-fish-of-america/brook_trout.html. Accessed July 2020.
- USFWS. 2020d. Freshwater Fish of America, Largemouth bass. https://www.fws.gov/fisheries/freshwater-fish-of-america/largemouth_bass.html. Accessed July 2020.
- USFWS. 2020e. Freshwater Fish of America, Yellow perch. Accessed July 2020. https://www.fws.gov/fisheries/freshwater-fish-of-america/yellow_perch.html. Accessed July 2020.
- USFWS and NOAA Fisheries. 2018. *Recovery plan for the Gulf of Maine Distinct Population Segment of Atlantic salmon (Salmo salar)*. 74 pp.
- U.S. Geological Survey (USGS). 2014. ECSTDB2014.SHP: U.S. Geological Survey East Coast Sediment Texture Database (2014): Open-File Report 2005-1001. U.S. Geological Survey, Coastal and Marine Geology Program, Woods Hole Coastal and Marine Science Center, Woods Hole, MA.
- University of Rhode Island Environmental Data Center (URI EDC). 1998a. Northern Sea Robin (*Prionotus carolinus*). Adapted from *The Uncommon Guide to Common Life on Narragansett Bay*. Save The Bay. <https://www.edc.uri.edu/restoration/html/gallery/fish/robin.htm>. Accessed June 22, 2020.
- URI EDC. 1998b. Atlantic Silverside (*Menidia menidia*). Adapted from *The Uncommon Guide to Common Life on Narragansett Bay*. Save The Bay. <http://www.edc.uri.edu/restoration/html/gallery/fish/silver.htm>. Accessed June 22, 2020.
- URI EDC. 2017. Striped Bass (*Morone saxatilis*). <https://www.edc.uri.edu/restoration/html/gallery/fish/bass.htm>. Accessed June 22, 2020.
- University of Rhode Island Graduate School of Oceanography (URI GSO). 2019. Annual Fish Trawl Survey Report and Data. Data from 2013-2018.
- Vabø, R., K. Olsen, and I. Huse. 2002. The effect of vessel avoidance of wintering Norwegian spring spawning herring. *Fisheries Research* 58: 59–77.
- Vandendriessche, S., A.M. Ribeiro da Costa, and K. Hostens. 2016. Wind farms and their influence on the occurrence of ichthyoplankton and squid larvae. *Environmental impacts of*

CONSTRUCTION AND OPERATIONS PLAN

References – Section 4 – Site Characterization and Assessment of Impacts

- offshore wind farms in the Belgian part of the North Sea: Environmental impact monitoring reloaded. Royal Belgian Institute of Natural Sciences, OD Natural Environment, Marine Ecology and Management Section. S. Degraer, R. Brabant, B. Rumes and L. E. Vigin, Eds. Pages 117-140.
- Walsh, H.J., D.E. Richardson, K.E. Marancik, and J.A. Hare. 2015. Long-Term Changes in the Distributions of Larval and Adult Fish in the Northeast U.S. Shelf Ecosystem. PLoS One 10(9): e0137382.
- Werner, R. G. 2004. *Freshwater fishes of the northeastern United States: a field guide*. 1st ed Syracuse, N.Y.: Syracuse University Press.
- Westerberg, H. and M.L. Begout Anras. 1999. Orientation of silver eel (*Aguilla anguilla*) in a disturbed geomagnetic field. Advances in fish telemetry. In Proceedings of the Third Conference on Fish Telemetry in Europe, Norwich, England.
- Wilber, D., D.A. Carey, L. Read, and M. Griffin. 2017. Block Island Wind Farm Demersal Fish Trawl Survey: Annual Report October 2015 through September 2016. INSPIRE Environmental. February. p. 153.
- Wilhelmsson D., T. Malm, and M.C. Öhman. 2006. The influence of offshore wind power on demersal fish. ICES Journal of Marine Science 63: 775–84.
- Wood, A.J.M., J.S. Collie, and J.A. Hare. 2009. A comparison between warm-water fish assemblages of Narragansett Bay and those of Long Island Sound waters. Fishery Bulletin 107:89–100.
- Zemeckis, D. R., Dean, M. J., and Cadrin, S. X. 2014. Spawning dynamics and associated management implications for Atlantic cod. North American Journal of Fisheries Management, 34: 424–442.
- #### 5.4.4.4 Marine Mammals
- Arnould, J.P, J. Monk, D. Lerodiasconou, M.A. Hindell, J. Semmens, A.J. Hoskins, D.P. Costa, K. Abernathy, and G.J. Marshall. 2015. Use of Anthropogenic Sea Floor Structures by Australian Fur Seals: Potential Positive Ecological Impacts of Marine Industrial Development? PLoS One 10(7):e0130581.
- Atlantic Marine Conservation Society (AMCS). 2021. Harbor and Gray Seal Surveys. <http://www.amseas.org/harbor-gray-seal-surveys>. Accessed March 2021.
- AMCS. 2020. AMSEAS Responds to Three Whales in Two Days. Accessed July 2020. <https://www.amseas.org/source-blog-2/2020/7/20/amseas-responds-to-three-whales-in-two-days>. Accessed July 2020.
- Au, W.W.L., and M. Green. 2000. Acoustic interaction of humpback whales and whale-watching boats. Marine Environmental Research 49: 469-482.
- Baker, C.S., L.M. Herman, B.G. Bays, and G. Bauer. 1983. The impact of vessel traffic on the behavior of humpback whales in southeast Alaska, 1982 season. Honolulu, Hawaii (Honolulu 96822). Accessed July 2010. file:///C:/Users/ewitherington/Downloads/Baker%20et%20al%201983_book.pdf

CONSTRUCTION AND OPERATIONS PLAN

References – Section 4 – Site Characterization and Assessment of Impacts

- Barkaszi, M.J., and C.J. Kelly. 2019. Seismic Survey Mitigation Measures and Protected Species Observer Reports: Synthesis Report-Corrected Version. OCS Study BOEM 2019-02. https://www.researchgate.net/profile/Mary_Jo_Barkaszi/publication/335925587_Seismic_survey_mitigation_measures_and_protected_species_observer_reports_synthesis_report/link/s/5d842aa8458515cbd19f4752/Seismic-survey-mitigation-measures-and-protected-species-observer-reports-synthesis-report.pdf. Accessed July 2020.
- Barlas, M.E. 1999. The distribution and abundance of harbor seals (*Phoca vitulina concolor*) and gray seals (*Halichoerus grypus*) in southern New England, winter 1998-summer 1999 (M.A. Thesis). Boston University, 52 pp.
- Baulch, S. and C. Perry. 2014. Evaluating the impacts of marine debris on cetaceans. *Marine Pollution Bulletin* 80(1-2) 210-221.
- Benjamins, S., W. Ledwell, J. Huntington, and A.R. Davidson. 2012. Assessing changes in numbers and distribution of large whale entanglements in Newfoundland and Labrador, Canada. *Marine Mammal Science* 28(3): 579-601.
- Bergström, L., L. Kautsky, T. Malm, R. Rosenberg, M. Wahlberg, N. Åstrand Capetillo, and D. Wilhelmsson. 2014. Effects of offshore wind farms on marine wildlife—a generalized impact assessment. *Environmental Research Letters* 9(3):12.
- Boehlert, G.W. and A.B. Gill. 2010. Environmental and Ecological Effects of Ocean Renewable Energy Development: A Current Synthesis. *Oceanography* 23(2):68-81.
- Bonar, P.A.J., I.G. Bryden, and A.G.L. Borthwick. 2015. Social and ecological impacts of marine energy development. *Renewable and Sustainable Energy Reviews* 47(2015):486-495.
- Brabyn, M. and R.V.C Frew. 1994. New Zealand herd stranding sites do not relate to geomagnetic topography. *Marine Mammal Science* 10:195-207.
- Bureau of Ocean Energy Management (BOEM). 2013. Commercial Wind Lease Issuance and Site Assessment Activities on the Atlantic Outer Continental Shelf Offshore Rhode Island and Massachusetts, Revised Environmental Assessment. Office of Renewable Energy Programs. OCSEIS/EA. BOEM 2013-1131.
- BOEM. 2014. Commercial Wind Lease Issuance and Site Assessment Activities on the Atlantic Outer Continental Shelf Offshore Massachusetts, Revised Environmental Assessment. OCS EIS/EA, BOEM 2014-603.
- BOEM. 2018. Methodology for Analyzing the Effects of the Block Island Wind Farm (BIWF) on Rhode Island Recreation and Tourism Activities. U.S. Department of the Interior Bureau of Ocean Energy Management, Office of Renewable Energy Programs Environmental Studies Program. https://espis.boem.gov/final%20reports/BOEM_2018-068.pdf. Accessed February 27, 2020.
- BOEM. 2019. Guidelines for Providing Information on Marine Mammals and Sea Turtles for Renewable Energy Development on the Atlantic Outer Continental Shelf Pursuant to 30 CFR Part 585. <https://www.boem.gov/sites/default/files/renewable-energy-program/Regulatory-Information/BOEM-Marine-Mammals-and-Sea-Turtles-Guidelines.pdf>. Accessed April 2020.

CONSTRUCTION AND OPERATIONS PLAN

References – Section 4 – Site Characterization and Assessment of Impacts

- BOEM. 2020a. Information Guidelines for Renewable Energy Construction and Operations Plan. <https://www.boem.gov/sites/default/files/documents/about-boem/COP%20Guidelines.pdf>. Accessed July 2020.
- BOEM. 2020b. Environmental Studies Program: Ongoing Study, Risk Assessment to Model Encounter Rates between Large Whales and Vessel Traffic from Offshore Wind Energy on the Atlantic OCS (AT-19-01). <https://www.boem.gov/sites/default/files/documents/environment/environmental-studies/Risk%20Analysis%20for%20Vessel%20Strikes.pdf>. Accessed August 5, 2020.
- Cates, K., D.P. DeMaster, R.L. Brownell Jr, G. Silber, S. Gende, R. Leaper, F. Ritter and S. Panigada. 2019. Strategic Plan to Mitigate the Impacts of Ship Strikes on Cetacean Populations: 2017-2020. IWC Strategic Plan to Mitigate Ship Strikes – March 2017.
- Center for Coastal Studies (CFCS). 2019. Committed to Science that Matters. <https://coastalstudies.org/>. Accessed July 2020.
- Cheesman S. 2016. Measurements of Operational Wind Turbine Noise in UK Waters. In: Popper A., Hawkins A. (eds) The Effects of Noise on Aquatic Life II. Advances in Experimental Medicine and Biology, vol 875. Springer, New York, NY.
- Coastal Research and Education Society of Long Island, Inc. (CRESLI). 2020. CRESLI Seal Research. https://www.cresli.org/common/news/articles/article_detail.cfm?QID=10936&clientID=12000&topicID=0&subsection=sidebar%20/. Accessed August 2020. Coates, D.A., Y. Deschutter, M. Vincx, and J. Vanaverbeke. 2014. Enrichment and shifts in macrobenthic assemblages in an offshore wind farm area in the Belgian part of the North Sea. Marine Environmental Research 95:1-12.
- Conn, P.B., and G.K. Silber. 2013. Vessel speed restrictions reduce risk of collision-related mortality for North Atlantic right whales. *Ecosphere* 4(4).
- Cremer, M.J., A.S. Barreto, F.A.S. Hardt, A.J. Tonello Júnior, and R. Mounayer. 2009. Cetacean occurrence near an offshore oil platform in southern Brazil. *Biotemas* 22(3):247-251.
- CSA Ocean Sciences Inc. 2020. Application for incidental harassment authorization for the non-lethal taking of marine mammals: site characterization surveys Lease OCS-A 0486, 0517, 0487, 0500 and Associated Export Cable Routes. Submitted to Orsted. July 2020. 89 pp.
- Curtice, C., J. Cleary, E. Shumchenia, and P.N. Halpin. 2019. Marine-life Data and Analysis Team (MDAT) technical report on the methods and development of marine-life data to support regional ocean planning and management. Prepared on behalf of the Marine-life Data and Analysis Team (MDAT). <http://seamap.env.duke.edu/models/MDAT/MDAT-Technical-Report.pdf>. Accessed July 2020.
- DiGiovanni, R.A., and A.M. Sabrosky. 2010. A note on seal watching in the Northeast United States. *NAMMCO Science Publications* 8: 373-377.
- Dolman, S., M. Green, E. Heskett, J. Reynolds, and N. Rose. 2006. Environmental Caucus Statement for The Report of the Advisory Committee on Acoustic Impacts on Marine Mammals to the Marine Mammal Commission. <https://www.mmc.gov/wp-content/uploads/fullsoundreport.pdf>. Accessed July 2020.

CONSTRUCTION AND OPERATIONS PLAN

References – Section 4 – Site Characterization and Assessment of Impacts

- Ellison, W.T., B.L. Southall, C.W. Clark, and A.S. Frankel. 2012. A new context-based approach to assess marine mammal behavioral responses to anthropogenic sounds. *Conservation Biology*. 26(1):21-28.
- English, P.A., T.I. Mason, J.T. Backstrom, B.J. Tibbles, A.A. Mackay, M.J. Smith, and T. Mitchell. 2017. Improving Efficiencies of National Environmental Policy Act Documentation for Offshore Wind Facilities Case Studies Report. OCS Study BOEM 2017-026. U.S. Department of the Interior, Bureau of Ocean Energy Management, Office of Renewable Energy Programs, Sterling, Virginia. pp 217.
- Finneran, J.J. 2016. Auditory Weighting Functions and TTS/PTS Exposure Functions for Marine Mammals Exposed to Underwater Noise. Technical Report 3026. Accessed July 2020. <https://apps.dtic.mil/dtic/tr/fulltext/u2/1026445.pdf>.
- Friedlaender, A.S., E.L. Hazen, D.P. Nowacek, P.N. Halpin, C. Ware, M.T. Weinrich, T. Hurst, and D. Wiley. 2009. Diel changes in humpback whale *Megaptera novaeangliae* feeding behavior in response to sand lance *Ammodytes* spp. behavior and distribution. *Marine Ecology Progress Series* 395:91-100.
- Garzke, J., S.M.H. Ismar, and U. Sommer. 2014. Climate change affects low trophic level marine consumers: warming decreases copepod size and abundance. *Oecologia* DOI 10.1007/s00442-014-3130-4.
- Gill, A.B. and J.A. Kimber. 2005. The potential for cooperative management of elasmobranchs and offshore renewable energy development in UK waters. *Journal of Marine Biology Association of the United Kingdom* 85: 1075-1081.
- Glass, A.H., Cole, T.V.N., and M. Geron. 2009. Mortality and serious injury determinations for baleen whale stocks along the United States eastern seaboard and adjacent Canadian Maritimes, 2003–2007. U.S. Department of Commerce, National Oceanographic and Atmospheric Administration, Northeast Fisheries Science Center. Document 09-04. 18 pp.
- Greene, C.H., and A.J. Pershing. 2004. Climate and the Conservation Biology of North Atlantic Right Whales: The Right Whale at the Wrong Time? *Frontiers in Ecology and the Environment* 2(1): 29-34.
- Halpin, P.N., A.J. Read, E. Fujioka, B.D. Best., B. Donnelly, L.J. Hazen, C. Kot, K. Urian, E. LaBrecque, A. Dimatteo, J. Cleary, C. Good, L.B. Crowder, and K.D. Hyrenbach. 2009. OBIS-SEAMAP: The World Data Center for Marine Mammal, Sea Bird, and Sea Turtle Distributions. *Oceanography* 22(2):104–115, doi:10.5670/oceanog.2009.42.
- Hammar, L., S. Andersson, and R. Rosenberg. 2010. Adapting Offshore Wind Power Foundations to Local Environment. For the Swedish Environmental Protection Agency, by Vindval. Report 6367. 87 pp.
- Harnois, V., H.C.M. S. Smith, L. Benjamins, and L. Johanning. 2015. Assessment of entanglement risk to marine megafauna due to offshore renewable energy mooring systems. *International Journal of Marine Energy*. Accessed July 2020.

CONSTRUCTION AND OPERATIONS PLAN

References – Section 4 – Site Characterization and Assessment of Impacts

- Hayes, S.A., E. Josephson, K. Maze-Foley, and P.E. Rosel (eds.). 2017. US Atlantic and Gulf of Mexico Marine Mammal Stock Assessments -- 2016. National Oceanographic and Atmospheric Administration. Technical Memorandum NMFS-NE 241. 274 pp.
- Hayes, S.A., E. Josephson, K. Maze-Foley, P.E. Rosel, B. Byrd, S. Chavez-Rosales, T.V.N. Cole, L. Engleby, L.P. Garrison, J. Hatch, A. Henry, S.C. Horstman, J. Litz, M.C. Lyssikatos, K.D. Mullin, C. Orphanides, R.M. Pace, D.L. Palka, M. Soldevilla, and F.W. Wenzel. 2018. US Atlantic and Gulf of Mexico Marine Mammal Stock Assessments - 2017. National Oceanographic and Atmospheric Administration. Technical Memorandum NMFS NE-245. 371 pp.
- Hayes, S.A., E. Josephson, K. Maze-Foley, and P.E. Rosel. 2019. US Atlantic and Gulf of Mexico Marine Mammal Stock Assessments - 2018. National Oceanic and Atmospheric Administration. Technical Memorandum NMFS-NE 258. 291 pp.
- Hayes, S.A., E. Josephson, K. Maze-Foley, and P.E. Rosel. 2020. US Atlantic and Gulf of Mexico Marine Mammal Stock Assessments – 2019 (Draft). National Oceanic and Atmospheric Administration. Technical Memorandum NMFS-NE 258. 399 pp.
- HDR. 2019. Field Observations during Wind Turbine Operations at the Block Island Wind Farm, Rhode Island. Final Report to the U.S. Department of the Interior, Bureau of Ocean Energy Management, Office of Renewable Energy Programs. OCS Study BOEM 2019-028. 281 pp.
- Henry, A.G., T.V.N. Cole, L. Hall, W. Ledwell, D. Morin and A. Reid. 2020. Serious Injury and Mortality Determinations for Baleen Whale Stocks along the Gulf of Mexico, United States East Coast, and Atlantic Canadian Provinces, 2013-2017. Unpublished report to the International Whaling Commission. PR/B/822.
- Hoover, K., S. Sadove, and P. Forestell. 1999. Trends of harbor seal, *Phoca vitulina*, abundance from aerial surveys in New York waters: 1985 to 1999. Proceedings of the 13th Biennial Conference on the Biology of Marine Mammals, Wailea, Hawaii, Nov. 28 – Dec. 3, 1999.
- Hui, C.A. 1994. Lack of association between magnetic patterns and the distribution of free-ranging dolphins. *Journal of Mammalogy* 75(2):399-405.
- Hutchison, Z, P. Sigray, H. He, A. Gill, J. King, C. Gibson. 2018. Electromagnetic Field (EMF) Impacts on Elasmobranch (shark, rays, and skates) and American Lobster Movement and Migration from Direct Current Cables. Report by University of Rhode Island, Cranfield University, and FOI (Swedish Defence Research Agency).
- Jensen, A.S. and G.K. Silber. 2003. Large Whale Ship Strike Database. U.S. Department of Commerce, National Oceanographic and Atmospheric Administration, National Marine Fisheries Service. NOAA Technical Memorandum NMFS-OPR. 37 pp.
- Kenney, R.D. and K.J. Vigness-Raposa. 2010. Marine Mammals and Sea Turtles of Narragansett Bay, Block Island Sound, Rhode Island Sound, and Nearby Waters: An Analysis of Existing Data for the Rhode Island Ocean Special Area Management Plan. In: RICRMC (Rhode Island Coastal Resources Management Council). 2010. Rhode Island Ocean Special Area Management Plan (OceanSAMP), volumes 1 and 2. Available at: <http://seagrant.gso.uri.edu/oceansamp/documents.html>.
- Kirschvink, J.L. 1990. Geomagnetic sensitivity in cetaceans: an update with live stranding records in the United States. *Sensory Abilities of Cetaceans*. 639-649.

CONSTRUCTION AND OPERATIONS PLAN

References – Section 4 – Site Characterization and Assessment of Impacts

- Kraus, S.D., S. Leiter, K. Stone, B. Wikgren, C. Mayo, P. Hughes, R. D. Kenney, C. W. Clark, A. N. Rice, B. Estabrook, and J. Tielens. 2016. Northeast Large Pelagic Survey Collaborative Aerial and Acoustic Surveys for Large Whales and Sea Turtles. US Department of the Interior, Bureau of Ocean Energy Management, Sterling, Virginia. OCS Study BOEM 2016-054. 117 pp. + appendices.
- Kraus, S.D. 2018. North Atlantic Right Whales: From Hunted Leviathan to Conservation Icon. ISBN 13: 9781421420981. John Hopkins University Press, Baltimore, MD. 432 pp.
- Kraus, S.D., R.D. Kenney, and L. Thomas. 2019. A Framework for Studying the Effects of Offshore Wind Development on Marine Mammals and Turtles. Report prepared for the Massachusetts Clean Energy Center, Boston, MA 02110 and the Bureau of Ocean Energy Management. <https://www.boem.gov/sites/default/files/environmental-stewardship/Environmental-Studies/Renewable-Energy/A-Framework-for-Studying-the-Effects.pdf>. Accessed July 2020.
- Laist, D.W., A.R. Knowlton, J.G. Mead, A.S. Collet, and M. Podesta. 2001. Collisions Between Ships and Whales. *Marine Mammal Science* 17(1):35-75.
- Langhamer, O. 2012. Artificial Reef Effect in relation to Offshore Renewable Energy Conversion: State of the Art. *The Scientific World Journal* 2012(386713):1-8.
- Learmonth, J.A., C.D. Macleod, M.B. Santos, G.J. Pierce, H.Q.P. Crick, and R.A. Robinson. 2006. Potential effects of climate change on marine mammals. *Oceanography and Marine Biology: An Annual Review* 44: 431-464.
- Lefebvre, L.W., M. Marmontel, J.P. Reid, G.B. Rathbun, and D.P. Domning. 2001. Status and biogeography of the West Indian manatee. In: C.A. Woods and F.E. Sergil, eds. *Biography of the West Indies, patterns and perspectives*. Pp. 425-474. Second edition. CRW Press, Boca Raton, FL.
- Leggat, L.J., H.M. Merklinger, and J.L. Kennedy. 1981. LNG carrier underwater noise study for Baffin Bay. *The Journal of the Acoustical Society of America* 69(S20):31-50.
- Lindeboom, H.J., H.J. Kouwenhoven, M.J.N. Bergman, S. Bouma, S. Brasseur, R. Daan, R.C. Fijn, D. De Haan, S. Dirksen, R. van Hal, R. Hille Ris Lambers, R. ter Hofstede, K.L. Krijgsveld, M. Leopold, and M. Scheidat. 2011. Short-term ecological effects of an offshore wind farm in the Dutch coastal zone; a compilation. *Environmental Research Letters* 6(3):035101.
- Long Island Pulse. 2017. Where to Seal Watch on Long Island. <http://lipulse.com/2017/02/13/where-to-seal-watch-on-long-island/>. Accessed August 5, 2020.
- MacLeod, C.D. 2009. Global climate change, range changes and potential implications for the conservation of marine cetaceans: a review and synthesis. *Endangered Species Research* 7: 125-136.
- Madsen, P.T., M. Wahlberg, J. Tougaard, K. Lucke, and A.P. Tyack. 2006. Wind turbine underwater noise and marine mammals: implications of current knowledge and data needs. *Marine ecology progress series*, 309, pp.279-295.

CONSTRUCTION AND OPERATIONS PLAN

References – Section 4 – Site Characterization and Assessment of Impacts

- Magalhães, S., R. Prieto, M.A. Silva, J. Goncalves, M. Afonso-Dias, and R.S. Santos. 2002. Short-term reactions of sperm whales (*Physeter macrocephalus*) to whale-watching vessels in the Azores. *Aquatic Mammals* 28.3: 267-274.
- Marine Mammal Commission. 2020. Ship Strikes and Right Whales. Available at <https://www.mmc.gov/priority-topics/species-of-concern/north-atlantic-right-whale/ship-strikes/>. Accessed December 2020.
- Matthews, L.P., M.E.H. Fournet, C. Gabriele, H. Klinck., and S.E. Parks. 2020. Acoustically advertising male harbour seals in southeast Alaska do not make biologically relevant acoustic adjustments in the presence of vessel noise. U.S. National Park Service Publications and Papers. https://digitalcommons.unl.edu/natlpark/207/?utm_source=digitalcommons.unl.edu%2Fnatlpark%2F207&utm_medium=PDF&utm_campaign=PDFCoverPages. Accessed August 2020.
- Meyer-Gutbrod, E.L., C.H. Greene, P.J. Sullivan, A.J. Pershing. 2015. Climate-associated changes in prey availability drive reproductive dynamics of the North Atlantic right whale population. *Marine Ecology Progress Series* 535: 243-258.
- Mikkelsen, L., K.N. Mouritsen, K. Dahl, J. Teilmann, and J. Tougaard, 2013. Re-established stony reef attracts harbour porpoises *Phocoena*. *Marine Ecology Progress Series* 481:239-248.
- Minerals Management Service (MMS). 2007. Final Programmatic Environmental Impact Statement for Alternative Energy Development and Production and Alternate Use of Facilities on the Outer Continental Shelf. U.S. Department of the Interior. OCS EIS/EA MMS 2007-046. pp.
- Mohr, F.C., B. Lasley, and S. Bursian. 2008. Chronic Oral Exposure to Bunker C Fuel Oil Causes Adrenal Insufficiency in Ranch mink (*Mustela vison*). *Archives of Environmental Contamination and Toxicology* 54: 337-347.
- Nalpathanchil, L., and H. Brandon. 2014. Rare Sighting of Beluga Whale in Massachusetts. Accessed August 2020. <https://www.wnpr.org/post/rare-sighting-beluga-whale-massachusetts#:~:text=From%20a%20report%20on%20Wednesday,spotting%20it%20from%20an%20aircraft>.
- National Oceanic Atmospheric Administration (NOAA) Fisheries. n.d.[a]. ESA Threatened and Endangered Species Directory. https://www.fisheries.noaa.gov/species-directory/threatened-endangered?title=&species_category=1000000031&species_status=any®ions=100000111&items_per_page=25&sort=. Accessed July 2020.
- NOAA Fisheries. 2012. Marine Mammal Acoustic Thresholds. http://www.westcoast.fisheries.noaa.gov/protected_species/marine_mammals/threshold_guidance.html. Accessed April 2020
- NOAA Fisheries. 2013. Final Recovery Plan for the North Pacific Right Whale (*Eubalaena japonica*). National Marine Fisheries Service, Office of Protected Resources, Silver Spring, MD
- NOAA Fisheries. 2018. 2018 Revisions to: Technical Guidance for Assessing the Effects of Anthropogenic Sound on Marine Mammal Hearing (Version 2.0): Underwater Thresholds

CONSTRUCTION AND OPERATIONS PLAN

References – Section 4 – Site Characterization and Assessment of Impacts

- for Onset of Permanent and Temporary Threshold Shifts. U.S. Department of Commerce, National Oceanic and Atmospheric Administration. NOAA Technical Memorandum NMFS-OPR-59. 167 pp.
- NOAA Fisheries. 2019a. Lone Bowhead Whale Sighted in Gulf of Maine. Accessed August 2020. <https://www.fisheries.noaa.gov/feature-story/lone-bowhead-whale-sighted-gulf-maine#:~:text=For%20the%20past%20few%20years,waters%20off%20Cape%20Cod%2C%20Massachusetts.&text=The%20confirmed%20sightings%20reported%20in,the%20western%20North%20Atlantic%20Ocean.>
- National Oceanic Atmospheric Administration (NOAA) Fisheries. 2019b. 2019 Marine Mammal Stock Assessment Reports by Region. Accessed August 2020. <https://www.fisheries.noaa.gov/national/marine-mammal-protection/marine-mammal-stock-assessment-reports-region.>
- NOAA Fisheries. 2019c. Draft 2019 Marine Mammal Stock Assessment Report, U.S. Atlantic and Gulf of Mexico Draft Marine Mammal Stock Assessment. U.S. Department of Commerce, National Oceanic and Atmospheric Administration, National Marine Fisheries Service. Draft published on 27 November 2019, 84 FR 65353. 399 pp.
- NOAA Fisheries. 2020a. Atlantic Marine Assessment Program for Protected Species. <https://www.fisheries.noaa.gov/new-england-mid-atlantic/population-assessments/atlantic-marine-assessment-program-protected.> Accessed July 2020.
- NOAA Fisheries. 2020b. 2018-2020 Pinniped Unusual Mortality Event Along the Northeast Coast. <https://www.fisheries.noaa.gov/new-england-mid-atlantic/marine-life-distress/2018-2020-pinniped-unusual-mortality-event-along.> Accessed December 2020.
- NOAA Fisheries. 2020c. Marine Mammal Stock Assessment Reports by Species/Stock. <https://www.fisheries.noaa.gov/national/marine-mammal-protection/marine-mammal-stock-assessment-reports-species-stock#cetaceans---large-whales.> Accessed July 2020.
- NOAA Fisheries. 2020d. Gray Seal. <https://www.fisheries.noaa.gov/species/gray-seal.> Accessed April 2020.
- NOAA Fisheries. 2020e. Humpback whale disentangled off New York All Thanks to a Team Effort. https://www.fisheries.noaa.gov/feature-story/humpback-whale-disentangled-new-york-all-thanks-team-effort?utm_medium=email&utm_source=govdelivery. Accessed August 6, 2020.
- National Oceanic Atmospheric Administration (NOAA) Fisheries. 2020f. 2016-2020 Humpback Whale Unusual Mortality Event Along the Atlantic Coast. Accessed December 2020. <https://www.fisheries.noaa.gov/national/marine-life-distress/2016-2020-humpback-whale-unusual-mortality-event-along-atlantic-coast.>
- NOAA Fisheries. 2020g. 2017-2020 Minke Whale Unusual Mortality Event along the Atlantic Coast. <https://www.fisheries.noaa.gov/national/marine-life-distress/2017-2020-minke-whale-unusual-mortality-event-along-atlantic-coast.> Accessed December 2020.

CONSTRUCTION AND OPERATIONS PLAN

References – Section 4 – Site Characterization and Assessment of Impacts

- NOAA Fisheries. 2020h. 2017-2020 North Atlantic Right Whale Unusual Mortality Event. <https://www.fisheries.noaa.gov/national/marine-life-distress/2017-2020-north-atlantic-right-whale-unusual-mortality-event>. Accessed December 2020.
- Newsday. 2020. As calls flood seal center, agency cautions beachgoers on sightings. <https://www.newsday.com/long-island/politics/seal-marine-rescue-1.43604707>. Accessed August 5, 2020.
- New York State Department of Environmental Conservation (NYSDEC). n.d. Marine Mammals of New York. <https://www.dec.ny.gov/animals/108573.html>. Accessed August 5, 2020.
- NYSDEC. 2021. Aerial Survey. <https://www.dec.ny.gov/lands/113818.html>. Accessed March 2021.
- NYSDEC. 2020. Marine Mammals of New York. <https://www.dec.ny.gov/animals/108573.html>. Accessed April 2020.
- New York State Energy Research and Development Authority (NYSERDA). 2017. New York State Offshore Wind Master Plan. Marine Mammals and Sea Turtles Study. NYSERDA Report 17-25. 164p.
- Normandeau Associates Inc. (Normandeau), Exponent Inc., Tricas, T., and A. Gill. 2011. Effects of EMFs from Undersea Power Cables on Elasmobranch and Other Marine Species. Camarillo, CA: U.S. Department of the Interior, Bureau of Ocean Energy Management, Regulation, and Enforcement, Pacific OCS Region. OCS Study BOEMRE 2011-09. pp.
- Normandaeu Associates, Inc. and APEM. 2019. Digital Aerial Baseline Survey of Marine Wildlife in Support of Offshore Wind Energy—Winter 2018-2019 Survey Summary Report. 6p.
- Nye, J.A., J.S. Link, J.A. Hare, and W.J. Overholtz. 2009. Changing spatial distribution of fish stocks in relation to climate and population size on the Northeast United States continental shelf. *Marine Ecology Progress Series* 393: 111-129.
- Palka, D.L, S. Chavez-Rosales, E. Josephson, D. Cholewiak, H.L. Haas, L. Garrison, M. Jones, D. Sigourney, G. Waring, M. Jech, E. Broughton, M. Soldevilla, G. Davis, A. DeAngelis, C.R. Sasso, M.V. Winton, R.J. Smolowitz, G. Fay, E. LaBrecque, J.B. Leiness, M. Warden, K. Murray K, and C. Orphanides. 2017. Atlantic Marine Assessment Program for Protected Species: 2010-2014. Washington, DC: U.S. Department of the Interior, Bureau of Ocean Energy Management, Atlantic OCS Region. OCS Study BOEM 2017-071. 211 pp.
- Pinsky, M.L., B. Worm, M.J. Fogarty, J.L. Sarmiento, and S.A. Levin. 2013. Marine Taxa Track Local Climate Velocities. *Science* 341: 1239-1242.
- Reeves, R.R., K. McClellan, and T.B. Werner. 2013. Marine mammal bycatch in gillnet and other entangling net fisheries, 1990 to 2011. *Endangered Species Research*. 2071-97.
- Richardson, W.J., C.R. Greene, C.I. Malme, and D.H. Thomson. 1995. *Marine Mammals and Noise*. Academic Press, Inc., San Diego, CA.
- Roberts, J.J., B.D. Best, L. Mannocci, E. Fujioka, P.N. Halpin, D.L. Palka, L.P. Garrison, K.D. Mullin, T.V.N. Cole, C.B. Khan, W.M. McLellan, D.A. Pabst, and G.G. Lockhart. 2016a. Habitat-based cetacean density models for the U.S. Atlantic and Gulf of Mexico. *Scientific Reports* 6: 22615. doi: 10.1038/srep22615.

CONSTRUCTION AND OPERATIONS PLAN

References – Section 4 – Site Characterization and Assessment of Impacts

- Roberts J.J., L. Mannocci, and P.N. Halpin. 2016b. Final Project Report: Marine Species Density Data Gap Assessments and Update for the AFTT Study Area, 2015-2016 (Base Year). Document version 1.0. Report prepared for Naval Facilities Engineering Command, Atlantic by the Duke University Marine Geospatial Ecology Lab, Durham, NC.
- Roberts J.J., L. Mannocci, and P.N. Halpin. 2017. Final Project Report: Marine Species Density Data Gap Assessments and Update for the AFTT Study Area, 2016-2017 (Opt. Year 1). Document version 1.4. Report prepared for Naval Facilities Engineering Command, Atlantic by the Duke University Marine Geospatial Ecology Lab, Durham, NC.
- Roberts J.J., L. Mannocci, R.S. Schick and P.N. Halpin. 2018. Final Project Report: Marine Species Density Data Gap Assessments and Update for the AFTT Study Area, 2017-2018 (Opt. Year 2). Report prepared for Naval Facilities Engineering Command, Atlantic by the Duke University Marine Geospatial Ecology Lab, Durham, NC. Document version 1.2. 75 pp.
- Russell, D.J.F., S. Brasseur, D. Thompson, G.D. Hastie, V.M. Janik, G. Aarts, B.T. McClintock, J. Matthiopoulos, S.E.W. Moss, and B. McConnell. 2014. Marine mammals trace anthropogenic structures at sea. *Current Biology* 24(14):R638-R639.
- Sadove, S.S., and P. Cardinale. 1993. Species Composition and Distribution of Marine Mammals and Sea Turtles in the New York Bight, Final Report to United States Fish and Wildlife Service Southern New England – New York Bight Coastal Estuaries Project.
- Scheidat, M., J. Tougaard, S. Brasseur, J. Carstensen, P.T. van Polanen, J. Teilmann, and P. Reijnders. 2011. Harbour Porpoise (*Phocoena phocoena*) and Wind Farms: A Case Study in the Dutch North Sea. *Environmental Research Letters* 6:1-10.
- Selden, R.L., R.D. Batt, V.S. Saba, and M.L. Pinsky. 2018. Diversity in thermal affinity among key piscivores buffers impacts of ocean warming on predator-prey interactions. *Global Change Biology* 24(1): 117-131.
- Silva JM. 2006. EMF Study: Long Island Power Authority (LIPA), Offshore Wind Project. 77 pp.
- Simmonds, M.P., and W.J. Elliott. 2009. Climate change and cetaceans: concerns and recent developments. *Journal of the Marine Biological Association of the United Kingdom* 89(1): 203-210.
- Slocum, C.J., R. Schoelkopf, S. Tulevech, M. Stevens, S. Evert, and M. Moyer. 1999. Seal Populations wintering in New Jersey (USA) have increased in abundance and diversity. Proceedings of the 13th Biennial Conference on the Biology of Marine Mammals, Wailea, Hawaii, Nov. 28 – Dec. 3, 1999.
- Smultea Environmental Sciences, LLC. 2019. Protected Species Observer Technical Report MAW01 Geotechnical Survey Bay State Wind Massachusetts (2019). Lease Area OCS-A 0500.
- Smultea Environmental Sciences (Smultea Sciences). 2020. Protected Species Observer Technical Report for the Ørsted Sunrise Wind Farm, BOEM Lease Areas OCS-A 0487/0500, Offshore Massachusetts and Rhode Island, 2019–2020. Final Report. Prepared by M.A. Smultea, P. Haase, O.M. Bates, E.L. Ferguson, and T. Souder. Prepared for Ørsted, One International Place, Suite 400, 100 Oliver Street Boston, MA 02110. 21 June 2020.

CONSTRUCTION AND OPERATIONS PLAN

References – Section 4 – Site Characterization and Assessment of Impacts

- Snyder, D.B., W.H. Bailey, Ph.D., K. Palmquist, Ph.D., B.R.T. Cotts, Ph.D., and K.R. Olsen. 2019. Evaluation of Potential EMF Effects on Fish Species of Commercial or Recreational Fishing Importance in Southern New England. U.S. Dept. of the Interior, Bureau of Ocean Energy Management, Headquarters, Sterling, VA. Report by CSA Ocean Sciences Inc. and Exponent. OCS Study BOEM 2019-049. 59 pp.
- Southall, B.L., A.E. Bowles, W.T. Ellison, J.J. Finneran, R.L. Gentry, C.R. Greene Jr., D. Kastak, D.R. Ketten, J.H. Miller, P.E. Nachtigall, W.J. Richardson, J.A. Thomas, and P.L. Tyack. 2007. Marine Mammal Noise Exposure Criteria: Initial Scientific Recommendations. *Aquatic Mammals*. 33(4):521.
- Southall, B.L., J.J. Finneran, C. Reichmuth, P.E. Nachtigall, D.R. Ketten, A.E. Bowles, W.T. Ellison, D.P. Nowacek, and P.L. Tyack. 2019. Marine Mammal Noise Exposure Criteria: Updated Scientific Recommendations for Residual Hearing Effects. *Aquatic Mammals* 45(2):125-232.
- Sullivan, L., T. Brosnan, T. Rowles, L. Schwacke, C. Simeone, and T.K. Collier. 2019. Guidelines for Assessing Exposure and Impacts of Oil Spills on Marine Mammals. NOAA Technical Memorandum NMFS-OPR-62.
file:///C:/Users/ewitherington/Downloads/noaa_22425_DS1.pdf. Accessed July 2020.
- Takeshita, R., L. Sullivan, C. Smith, T. Collier, A. Hall, T. Brosnan, T. Rowles, and L. Schwacke. 2017. The Deepwater Horizon oil spill marine mammal injury assessment. *Endangered Species Research* 33: 95-106.
- Teilmann, J. and J. Carstensen. 2012. Negative Long-term Effects on Harbour Porpoises from a Large-Scale Offshore Wind Farm in the Baltic-Evidence of Slow Recovery. *Environmental Research Letters* 7(4):10.
- Temte, J.L. 1994. Photoperiod control of birth timing in the harbour seal (*Phoca vitulina*). *Journal of Zoology*, 233(3), pp.369-384.
- Tetra Tech and LGL. 2020. Final Comprehensive Report for New York Bight Whale Monitoring Aerial Surveys, March 2017 – February 2020. Technical Report prepared by Tetra Tech, Inc. and LGL Ecological Research Associates, Inc. 211 pp. + appendices. Prepared for New York State Department of Environmental Conservation, Division of Marine Resources, East Setauket, NY. May 18, 2020.
- United States Fish and Wildlife Service (USFWS). n.d. Significant Habitats and Habitat Complexes of the New York Bight Watershed, Great South Bay Complex #14.
https://nctc.fws.gov/pubs5/web_link/text/gsb_form.htm. Accessed July 2020.
- United States Geological Survey (USGS). 2014. East Coast Sediment Texture Database (2014): Open-File Report 2005-1001. U.S. Geological Survey, Coastal and Marine Geology Program, Woods Hole Coastal and Marine Science Center, Woods Hole, MA.
- Van der Hoop, J.M., M.J. Moore, S.G. Barco, T.V.N. Cole, P. Daoust, A.G. Henry, D.F. MacAlpine, W.A. McLellan, T. Wimmer, and A.R. Solow. 2013. Assessment of Management to Mitigate Anthropogenic Effects on Large Whales. *Conservation Biology* 27(1): 121-133.

CONSTRUCTION AND OPERATIONS PLAN

References – Section 4 – Site Characterization and Assessment of Impacts

- Van der Hoop, J.M., A.S.M. Vanderlaan, T.V.N. Cole, A.G. Henry, L. Hall, B. Mase-Guthrie, T. Wimmer, and M.J. Moore. 2015. Vessel Strikes to Large Whales Before and After the 2008 Ship Strike Rule. *Conservation Letters* 8(1):24-32.
- Vanderlaan, A.S.M., and C.T. Taggart. 2007. Vessel Collisions with Whales: The Probability of Lethal Injury based on Vessel Speed. *Marine Mammal Science* 23(1): 144-156.
- Van der Stap, T., W.P. Joop, Coolen, and H.J. Lindeboom. 2016. Marine Fouling Assemblages on Offshore Gas Platforms in the Southern North Sea: Effects of Depth and Distance from Shore on Biodiversity. *Plos One* 11(1): e0146324. <https://doi.org/10.1371/journal.pone.0146324>
- Van Waerebeek, K., A.N. Baker, F. Félix, J. Gedamke, M. Iñiguez, G.P. Sanino, E. Secchi, D. Sutaria, A. van Helden, and Y. Wang. 2007. Vessel collisions with small cetaceans worldwide and with large whales in the Southern Hemisphere, an initial assessment. *Latin American Journal of Aquatic Mammals* 6(1):43-69.
- Waring, G.T., J.R. Gilbert, D. Belden, A. Van Atten, and R.A. DiGiovanni. 2010. A review of the status of harbour seals (*Phoca vitulina*) in the Northeast United States of America. *NAMMCO Science Publications* 8: 191-212.
- Watkins, W.A. 1986. Whale Reactions to human Activities in Cape Cod Waters. *Marine Mammal Science* 2(4): 251-262.
- Werner S., A. Budziak, J. van Franeker, F. Galgani, G. Hanke, T. Maes, M. Matiddi P. Nilsson, L. Oosterbaan, E. Priestland, R. Thompson, J. Veiga, T. Vlachogianni. 2016. Harm caused by Marine Litter. MSFD GES TG Marine Litter-Thematic Report; JRC Technical report; EUR 28317 EN; doi: 10.2788/690366.
- Wilhelmsson, D., T. Malm, and M.C. Öhman. 2006. The influence of offshore wind power on demersal fish. *ICES Journal of Marine Science* 63:775-784.
- Wiley, D.N., C.A. Mayo, E.M. Maloney, and M.J. Moore. 2016. Vessel strike mitigation lessons from direct observations involving two collisions between noncommercial vessels and North Atlantic right whales (*Eubalaena glacialis*). *Marine Mammal Science* 32(4):1501-1509.
- Wilson, D. and S. Ruff. 1999. *The Smithsonian Book of North American Mammals*. Washington: Smithsonian Institution Press.

5.4.4.5 Sea Turtles

- AM New York. 2018. Rare baby sea turtles hatch on Queens beach. <https://abcnews.go.com/US/dozens-endangered-baby-sea-turtles-hatched-york-city/story?id=58229791>. Accessed June 2020.
- Audubon. n.d. Important Bird Areas, Great South Bay. <https://www.audubon.org/important-bird-areas/great-south-bay>. Accessed June 2020.
- Baker, K., D.M. Epperson, G.R. Gitschlag, H.H. Goldstein, J. Lewandowski, K. Skrupky, B.K. Smith, and T.A. Turk. 2013. National standards for a protected species observer and data management program: A model using geological and geophysical surveys.

CONSTRUCTION AND OPERATIONS PLAN

References – Section 4 – Site Characterization and Assessment of Impacts

- Barkaszi, M.J. and C.J. Kelly. 2018. Seismic survey mitigation measures and protected species observer reports: synthesis report. U.S. Dept. of the Interior, Bureau of Ocean Energy Management, Gulf of Mexico OCS Region, New Orleans, LA. OCS Study BOEM 2019-012. 153 p.
- Barnette, M.C. 2017. Potential Impacts of Artificial Reef Development on Sea Turtle Conservation in Florida. National Oceanic and Atmospheric Administration, Technical Memorandum NMFS-SER-5. 36 pp.
- Bartol S.M., J.A. Music, and M. Lenhardt. 1999. Auditory evoked potentials of the loggerhead sea turtle (*Caretta caretta*). *Copeia* 3:836-840.
- Bartol, S.M. and D.R. Ketten. 2006. Turtle and tuna hearing. In: Y Swimmer, R Brill (Eds.), *Sea turtle and pelagic fish sensory biology: Developing techniques to reduce sea turtle bycatch in longline fisheries*. U.S. Department of Commerce, National Oceanographic and Atmospheric Administration: Technical Memorandum NMFS-PIFSC-7. pp. 8.
- Blackstock, S.A., J.O. Fayton, P.H. Hulton, T.E. Moll, K. Jenkins, S. Kotecki, E. Henderson, V. Bowman, S. Rider, and C. Martin. 2018. Quantifying Acoustic Impacts on Marine Mammals and Sea Turtles: Methods and Analytical Approach for Phase III Training and Testing. Newport, RI: Naval Undersea Warfare Center Division. NUWC-NPT Technical Report. 51 pp.
- Bonacci-Sullivan, L. 2018. Summary Report of the New York Bight Sea Turtle Workshop. Prepared for the New York State Department of Environmental Conservation. https://www.dec.ny.gov/docs/fish_marine_pdf/dmrturtlereport.pdf. Accessed November 2020.
- Bureau of Ocean Energy Management (BOEM). 2013. Commercial Wind Lease Issuance and Site Assessment Activities on the Atlantic Outer Continental Shelf Offshore Rhode Island and Massachusetts, Revised Environmental Assessment. Office of Renewable Energy Programs. OCSEIS/EA. BOEM 2013-1131.
- BOEM. 2018. Summary Report: Best Management Practices Workshop for Atlantic Offshore Wind Facilities and Marine Protected Species (2017). Sterling, VA: US Department of Interior, Bureau of Ocean Energy Management, Atlantic OCS Region, Washington, D.C. OCS Study BOEM 2018- 015. March 2018. Available online: <https://www.boem.gov/Final-Summary-Report-for-BMPWorkshop-BOEM/>. Accessed June 21, 2019.
- BOEM. 2019a. Guidelines for Providing Information on Marine Mammals and Sea Turtles for Renewable Energy Development on the Atlantic Outer Continental Shelf Pursuant to 30 CFR Part 585. <https://www.boem.gov/sites/default/files/renewable-energy-program/Regulatory-Information/BOEM-Marine-Mammals-and-Sea-Turtles-Guidelines.pdf>. Accessed June 2020
- BOEM. 2019b. Vineyard Wind Offshore Wind Energy Project Biological Assessment. December 2018 (Revised March 2019) For the National Marine Fisheries Service. <https://www.boem.gov/sites/default/files/documents/renewable-energy/NMFS-BA-Supplemental-info.pdf>. Accessed June 2020.

CONSTRUCTION AND OPERATIONS PLAN

References – Section 4 – Site Characterization and Assessment of Impacts

- Burke, V.J., E.A. Standora, and S.J. Morreale. 1991. Factors affecting strandings of cold-stunned juvenile Kemp's ridley and loggerhead sea turtles in Long Island, New York. *Copeia* 4:1136-1138.
- Cetacean and Turtle Assessment Program (CETAP). 1982. A characterization of marine mammals and turtles in the mid- and north Atlantic areas of the USA outer continental shelf. Cetacean and Turtle Assessment Program, University of Rhode Island. Final Report #AA551-CT8-48 to the Bureau of Land Management, Washington, DC. 538 pp.
- CSA Ocean Sciences Inc. 2020. Application for incidental harassment authorization for the non-lethal taking of marine mammals: site characterization surveys Lease OCS-A 0486, 0517, 0487, 0500 and Associated Export Cable Routes. Submitted to Orsted. July 2020. 89 pp.
- Curtice, C., J. Cleary, E. Shumchenia, and P.N. Halpin. 2019. Marine-life Data and Analysis Team (MDAT) technical report on the methods and development of marine-life data to support regional ocean planning and management. Prepared on behalf of the Marine-life Data and Analysis Team (MDAT). <http://seamap.env.duke.edu/models/MDAT/MDAT-Technical-Report.pdf>. Accessed August 2020.
- Davenport, J. 1997. Temperature and the life-history strategies of sea turtles. *Journal of Thermal Biology*. 22:10.
- DeRuiter, S.S. and K.L. Doukara. 2012. Loggerhead turtles dive in response to airgun sound exposure. *Endangered Species Research* 16:55-63.
- Dickerson, D., M. Wolters, C. Theriot, and C. Slay. 2004. Dredging Impacts on Sea Turtles in the Southeastern USA: A Historical Review of Protection. http://seaturtle.org/library/DickersonD_2004_InWODCONXVIIIDredginginaSensitiveEnvir_px-x-xx.pdf. Accessed June 2020.
- Dow Piniak, W.E., S.A. Eckert, C.A. Harms, and E.M. Stringer. 2012a. Underwater hearing sensitivity of the leatherback sea turtle (*Dermochelys coriacea*): Assessing the potential effect of anthropogenic noise. Headquarters, Herndon, VA: U.S. Department of the Interior, Bureau of Ocean Energy Management. OCS Study BOEM 2012-01156. 35 pp.
- Dow Piniak, W.E., D.A. Mann, S.A. Eckert, and C.A. Harms. 2012b. Amphibious Hearing in Sea Turtles. In: AN Popper, A Hawkins (Eds.), *The Effects of Noise on Aquatic Life*. Advances in Experimental Medicine and Biology. New York, NY: Springer. pp. 83-87.
- Epperly, S. 2017. Technical and Legal Analysis in Support of the Petition to Designate the Northwest Atlantic Leatherback Subpopulation of Sea Turtles as a Distinct Population Segment (DPS) and List the DPS as Threatened under the Endangered Species Act. <https://ecos.fws.gov/docs/petitions/92000/1022.pdf>. Accessed July 2020.
- Fuentes, M.M.P.B. and D. Abbs. 2010. Effects of Projected Changes in Tropical Cyclone Frequency on Sea Turtles. *Marine Ecology Progress Series* 412:283-292.
- Gallaway, B.J. 1981. An Ecosystem Analysis of Oil and Gas Development in the Texas-Louisiana Continental Shelf. Washington, DC: U.S. Fish and Wildlife Service. FWS/OBS-81-27.
- Gitschlag, G.R. 1990. Sea turtle monitoring at offshore oil and gas platforms. Pp. 223–246 in *Proceedings of the 10th Annual Workshop on Sea Turtle Biology and Conservation*.

CONSTRUCTION AND OPERATIONS PLAN

References – Section 4 – Site Characterization and Assessment of Impacts

- Gitschlag, G.R. and B.A. Herczeg. 1994. Sea turtle observations at explosive removals of energy structures. *Marine Fisheries Review*, 56(2):1-8.
- Halpin, P.N., A.J. Read, E. Fujioka, B.D. Best, B. Donnelly, L.J. Hazen, C. Kot, K. Urian, E. LaBrecque, A. Dimatteo, J. Cleary, C. Good, L.B. Crowder, and K.D. Hyrenbach. 2009. OBIS-SEAMAP: The World Data Center for Marine Mammal, Sea Bird, and Sea Turtle Distributions. *Oceanography* 22(2):104–115, doi:10.5670/oceanog.2009.42.
- Hawkes, L.A., A.C. Broderick, M.H. Godfrey, and B.J. Godley. 2009. Climate change and marine turtles. *Endangered Species Research* 7(2): 137-154.
- Hazel, J., I.R. Lawler, and M. Hamann. 2009. Diving at the shallow end: green turtle behaviour in nearshore foraging habitat. *Journal of Experimental Marine Biology and Ecology* 371(1): 84-92.
- HDR. 2019. Field Observations during Wind Turbine Operations at the Block Island Wind Farm, Rhode Island. Final Report to the U.S. Department of the Interior, Bureau of Ocean Energy Management, Office of Renewable Energy Programs. OCS Study BOEM 2019-028. 281 pp.
- Hochscheid, S., F. Bentivegna, A. Hamza, and G.C. Hays. 2010. When surfacers do not dive: multiple significance of extended surface times in marine turtles. *Journal of Experimental Biology* 213(8):1328-1337.
- Hutchison, Z., P. Sigray, H. He, A. Gill, J. King, and C. Gibson. 2018. Electromagnetic Field (EMF) Impacts on Elasmobranch (shark, rays, and skates) and American Lobster Movement and Migration from Direct Current Cables. Report by University of Rhode Island, Cranfield University, and FOI (Swedish Defence Research Agency).
- Janzen, F.J. 1994. Climate Change and Temperature-dependent Sex Determination in Reptiles. *Proceedings of the National Academy of Science* 91: 7487-7490.
- Kenney, R.D., and K.J. Vigness-Raposa. 2010. Marine Mammals and Sea Turtles of Narragansett Bay, Block Island Sound, Rhode Island Sound, and Nearby Waters: An Analysis of Existing Data for the Rhode Island Ocean Special Area Management Plan. In: RICRMC (Rhode Island Coastal Resources Management Council). 2010. Rhode Island Ocean Special Area Management Plan (OceanSAMP), volumes 1 and 2.
- Kraus, S.D., S. Leiter, K. Stone, B. Wikgren, C. Mayo, P. Hughes, R.D. Kenney, C.W. Clark, A.N. Rice, B. Estabrook, and J. Tielens. 2016. Northeast Large Pelagic Survey Collaborative Aerial and Acoustic Surveys for Large Whales and Sea Turtles. US Department of the Interior, Bureau of Ocean Energy Management, Sterling, Virginia. OCS Study BOEM 2016-054. 117 pp. + appendices.
- Kraus, S.D., R.D. Kenney, and L. Thomas. 2019. A Framework for Studying the Effects of Offshore Wind Development on Marine Mammals and Turtles. Report prepared for the Massachusetts Clean Energy Center, Boston, MA 02110, and the Bureau of Ocean Energy Management.
- Laist, D. W., A.R. Knowlton, J.G. Mead, A.S. Collet, and M. Podesta. 2001. Collisions between Ships and Whales. *Marine Mammal Science* 17:35–75.

CONSTRUCTION AND OPERATIONS PLAN

References – Section 4 – Site Characterization and Assessment of Impacts

- Langhamer, O. 2012. Artificial Reef Effect in relation to Offshore Renewable Energy Conversion: State of the Art. *The Scientific World Journal* 2012: 8.
- Lohmann, K.J. and C.M.F Lohmann. 1994. Detection of magnetic inclination angle by sea turtles: a possible mechanism for determining latitude. *Journal of Experimental Biology* 194:23-32.
- Lohmann, K.J. and C.M.F. Lohmann. 1996. Orientation and open-sea navigation in sea turtles. *Journal of Experimental Biology* 199:73-81.
- Lohmann, K.J., B.E. Witherington, C.M.F. Lohmann, and M. Salmon. 1997. Orientation, navigation, and natal beach homing in sea turtles. Pages 107-135 in P. L. Lutz and J. A. Musick, editors. *The Biology of Sea Turtles*. CRC Press, Boca Raton, FL.
- Lohmann, K.J., J.T. Hester, and C.M.F. Lohmann. 1999. Long-distance navigation in sea turtles. *Ethology Ecology & Evolution* 11:1-23.
- Lohmann, K.J., P. Luschi, and G.C. Hays. 2008. Goal navigation and island-finding in sea turtles. *Journal of Experimental Marine Biology and Ecology* 356:83-95.
- Luschi, P., S. Benhamou, C. Girard, S. Ciccione, D. Roos, J. Sudre, and S. Benvenuti. 1996. Marine Turtles Use Geomagnetic Cues during Open-Sea Homing. *Current Biology* 17(2):126-133.
- Martin, K.J., S.C. Alessi, J.C. Gaspard, A.D. Tucker, G.B. Bauer, and D.A. Mann. 2012. Underwater hearing in the loggerhead turtle (*Caretta caretta*): A comparison of behavioral and auditory evoked potential audiograms. *Journal of Experiment Biology* 215(17):3001-3009.
- MassWildlife Natural Heritage and Endangered Species Program (MA NHESP). 2020. List of Endangered, Threatened, and Special Concern Vertebrate Species in Massachusetts. <https://www.mass.gov/orgs/masswildlifes-natural-heritage-endangered-species-program>. Accessed June 2020.
- McCauley, R.D., J. Fewtrell, A.J. Duncan, C. Jenner, M.N. Jenner, J.D. Penrose, R.I.T. Prince, A. Adhitya, J. Murdoch, and K. McCabe. 2000. Marine Seismic Surveys - A Study of Environmental Implications. *APPEA Journal* 40(1):692-708.
- Meylan, A. and S. Sadove. 1986. Cold-stunning in Long Island Sound, New York. *Marine Turtle Newsletter* 37:7-8.
- Michel, J., A.C. Bejarano, C.H. Peterson, and C. Voss. 2013. Review of Biological and Biophysical Impacts from Dredging and Handling of Offshore Sand. U.S. Department of the Interior, Bureau of Ocean Energy Management, Herndon, VA. OCS Study BOEM 2013-0119. 258 pp.
- Minerals Management Service (MMS). 2007. Final Programmatic Environmental Impact Statement for Alternative Energy Development and Production and Alternate Use of Facilities on the Outer Continental Shelf. U.S. Department of the Interior. OCS EIS/EA MMS 2007-046. pp.
- Morreale, S.J., A.B. Meylan, S.S. Sadove, and E.A. Standora. 1992. Annual occurrence and winter mortality of marine turtles in New York waters. *Journal of Herpetology* 301-308.
- Murray, K.T. 2011. Interactions between sea turtles and dredge gear in the US sea scallop (*Placopecten magellanicus*) fishery, 2001–2008. *Fisheries Research* 107(1-3):137-146.

CONSTRUCTION AND OPERATIONS PLAN

References – Section 4 – Site Characterization and Assessment of Impacts

- National Oceanic Atmospheric Administration (NOAA). n.d. Great South Bay Nautical Chart 12352 Page C. nauticalcharts.noaa.gov. Accessed June 2020.
- National Oceanic Atmospheric Administration (NOAA Fisheries). n.d. ESA Threatened & Endangered Species Directory. <https://www.fisheries.noaa.gov/species-directory/threatened-endangered>. Accessed June 2020.
- NOAA Fisheries. 2017. 2017 Annual Report of a Comprehensive Assessment of Marine Mammal, Marine Turtle, and Seabird Abundance and Spatial Distribution in US waters of the Western North Atlantic Ocean – AMAPPS II. https://www.nefsc.noaa.gov/psb/AMAPPS/docs/AMAPPS%202017%20annual%20report_final.pdf. Accessed June 2020
- NOAA Fisheries. 2020. ESA Section 7 Mapper. <https://noaa.maps.arcgis.com/apps/webappviewer/index.html?id=1bc332edc5204e03b250ac11f9914a27>. Accessed June 2020.
- National Oceanic Atmospheric Administration Greater Atlantic Regional Fisheries Office (NOAA GARFO). 2016. GARFO Acoustics Tool: Analyzing the effects of pile driving on ESA-listed species in the Greater Atlantic Region (webpage). National Marine Fisheries Service. <https://www.greateratlantic.fisheries.noaa.gov/protected/section7/guidance/consultation/index.html>.
- NOAA GARFO. 2020a. Greater Atlantic Region Sea Turtle Program. <https://www.fisheries.noaa.gov/new-england-mid-atlantic/endangered-species-conservation/greater-atlantic-region-sea-turtle-program>. Accessed June 2020.
- NOAA GARFO. 2020b. Guidance for Carrying Out Endangered Species Act (ESA) Section 7 Consultations with NOAA Fisheries Greater Atlantic Regional Fisheries Office. file:///C:/Users/ewitherington/Downloads/GARFO%20ESA%20Section%207%20Technical%20Guidance_1312020_508.pdf. Accessed August 2020.
- National Oceanic Atmospheric Administration Southeast Fisheries Science Center (NOAA SEFSC). 2020. Sea Turtle Stranding and Salvage Network Reports Data Access Policy. <https://grunt.sefsc.noaa.gov/stssnrep/>. Accessed June 2020.
- NOAA Fisheries and U.S. Fish and Wildlife Service (USFWS). 1991. Recovery Plan for U.S. Population of the Atlantic Green Turtle (*Chelonia mydas*). Washington, D.C. 59 pp.
- NOAA Fisheries and USFWS. 1992. Recovery plan for leatherback turtles in the U.S. Caribbean, Atlantic, and Gulf of Mexico. National Marine Fisheries Service, Washington, D.C.
- National Research Council (NRC). 1996. An Assessment of Techniques for Removing Offshore Structures. Washington, DC: National Academy Press.
- Nelms, S.E., W.E.D. Piniak, C.R. Weir, and B.J. Godley. 2016. Seismic Surveys and Marine Turtles: An Underestimated Global Threat? *Biological Conservation* 193: 49-65.
- Newson, S.E., S. Mendes, H.Q.P. Crick, N.K. Dulvy, J.D.R. Houghton, G.C. Hays, A.M. Huston, MacLeod, C.D., Pierce, G.J., and R.A. Robinson. 2009. Indicators of the Impact of Climate Change on Migratory Species. *Endangered Species Research* 7:101-113.

CONSTRUCTION AND OPERATIONS PLAN

References – Section 4 – Site Characterization and Assessment of Impacts

- New York State Department of Environmental Conservation (NYSDEC). n.d. Sea Turtles of New York. <https://www.dec.ny.gov/animals/112355.html>. Accessed June 2020.
- NYSDEC. 2017. New York Ocean Action Plan 2017-2027. 128 p. https://www.dec.ny.gov/docs/fish_marine_pdf/nyoceanactionplan.pdf. Accessed June 2020.
- NYSDEC. 2020a. List of Endangered, Threatened and Special Concern Fish & Wildlife Species of New York State. <https://www.dec.ny.gov/animals/7494.html>. Accessed June 2020.
- NYSDEC. 2020b. Seagrass Management. <https://www.dec.ny.gov/lands/110813.html>. Accessed June 2020.
- New York State Energy Research and Development Authority (NYSERDA). 2017. New York State Offshore Wind Master Plan. Marine Mammals and Sea Turtles Study. NYSERDA Report 17-25. 164p. <https://www.nyserd.ny.gov/All-Programs/Programs/Offshore-Wind/About-Offshore-Wind/Master-Plan>. Accessed June 2020.
- Normandeau Associates Inc. (Normandeau), Exponent Inc., T. Tricas, and A. Gill. 2011. Effects of EMFs from Undersea Power Cable on Elasmobranchs and Other Marine Species. U.S. Dept. of the Interior, Bureau of Ocean Energy Management, Regulation, and Enforcement, Pacific OCS Region, Camarillo, CA. OCS Study BOEMRE 2011-09.
- Normandeau. 2016a. Digital Aerial Baseline Survey of Marine Wildlife in Support of Offshore Wind Energy, Summary of Fall 2016 Digital Survey #2. New York State Energy Research and Development Authority (NYSERDA).
- Normandeau. 2016b. Digital Aerial Baseline Survey of Marine Wildlife in Support of Offshore Wind Energy, Summary of Summer 2016 Digital Survey #1. New York State Energy Research and Development Authority (NYSERDA).
- Normandeau. 2017a. Digital Aerial Baseline Survey of Marine Wildlife in Support of Offshore Wind Energy, Summary of Spring 2017 Digital Survey #4. New York State Energy Research and Development Authority (NYSERDA).
- Normandeau. 2017b. Digital Aerial Baseline Survey of Marine Wildlife in Support of Offshore Wind Energy, Summary of Summer 2017 Digital Survey #5. New York State Energy Research and Development Authority (NYSERDA).
- Normandeau. 2017c. Digital Aerial Baseline Survey of Marine Wildlife in Support of Offshore Wind Energy, Summary of Winter 2017 Digital Survey #3. New York State Energy Research and Development Authority (NYSERDA).
- Normandeau. 2018. Digital Aerial Baseline Survey of Marine Wildlife in Support of Offshore Wind Energy, Summary of Fall 2017 Digital Survey #6. New York State Energy Research and Development Authority (NYSERDA).
- Normandeau and APEM. 2019. ReMOTe: Remote Marine and Onshore Technology, NYSERDA, Project Overview. https://remote.normandeau.com/aer_docs.php?pj=6. Accessed June 2020.

CONSTRUCTION AND OPERATIONS PLAN

References – Section 4 – Site Characterization and Assessment of Impacts

- O'Hara, J. and J.R. Wilcox. 1990. Avoidance Responses of Loggerhead Turtles, *Caretta*, to Low Frequency Sound. *Copeia* 1990(2):564-567.
- Palka, D.L. 2010. Appendix A Northern Leg of the AMAPPS Aerial Line-Transect Abundance Survey, 2010: Northeast Fisheries Science Center. Woods Hole, MA and Miami, FL: Northeast Fisheries Science Center and Southeast Fisheries Science Center. 2010 Annual Report to the Inter-Agency Agreement M10PG00075/0001: A Comprehensive Assessment of Marine Mammal, Marine Turtle, and Sea Bird Abundance and Spatial Distribution in U.S. Waters of the Western North Atlantic Ocean. 7-29 pp.
- Palka, D.L. 2011. Appendix A Northern leg of aerial abundance surveys during winter and summer 2011: Northeast Fisheries Science Center. Woods Hole, MA and Miami, FL: Northeast Fisheries Science Center and Southeast Fisheries Science Center. 2011 Annual Report to the Inter-Agency Agreement M10PG00075/0001: A Comprehensive Assessment of Marine Mammal, Marine Turtle, and Sea Bird Abundance and Spatial Distribution in U.S. Waters of the Western North Atlantic Ocean. 10-37 pp.
- Palka, D.L. 2012. Appendix A Northern leg of aerial abundance surveys during spring and fall 2012: Northeast Fisheries Science Center. Woods Hole, MA and Miami, FL: Northeast Fisheries Science Center and Southeast Fisheries Science Center. 2012 Annual Report to the Inter-Agency Agreement M10PG00075/0001: A Comprehensive Assessment of Marine Mammal, Marine Turtle, and Sea Bird Abundance and Spatial Distribution in U.S. Waters of the Western North Atlantic Ocean. 15-38 pp.
- Palka, D.L. 2013. Appendix B Northern leg of shipboard abundance surveys during summer 2013: Northeast Fisheries Science Center. Woods Hole, MA and Miami, FL: Northeast Fisheries Science Center and Southeast Fisheries Science Center. 2013 Annual Report to the Inter-Agency Agreement M10PG00075/0001: A Comprehensive Assessment of Marine Mammal, Marine Turtle, and Sea Bird Abundance and Spatial Distribution in U.S. Waters of the Western North Atlantic Ocean. 30-98 pp.
- Palka, D.L. 2014. Appendix A Northern leg of aerial abundance survey during February-March 2014: Northeast Fisheries Science Center. Woods Hole, MA and Miami, FL: Northeast Fisheries Science Center and Southeast Fisheries Science Center. 2014 Annual Report to the Inter-Agency Agreement M10PG00075/0001: A Comprehensive Assessment of Marine Mammal, Marine Turtle, and Sea Bird Abundance and Spatial Distribution in U.S. Waters of the Western North Atlantic Ocean. 14-23 pp.
- Palka, D.L. 2015. Appendix A Northern leg of aerial abundance survey during December 2014-January 2015: Northeast Fisheries Science Center. Woods Hole, MA and Miami, FL: Northeast Fisheries Science Center and Southeast Fisheries Science Center. 2015 Annual Report of a Comprehensive Assessment of Marine Mammal, Marine Turtle, and Seabird Abundance and Spatial Distribution in US Waters of the Western North Atlantic Ocean-AMAPPS II. 11-20 pp.
- Palka, D.L., S. Chavez-Rosales, E. Josephson, D. Cholewiak, H.L. Haas, L. Garrison, M. Jones, D. Sigourney, G. Waring, M. Jech, E. Broughton, M. Soldevilla, G. Davis, A. DeAngelis, C.R. Sasso, M.V. Winton, R.J. Smolowitz, G. Fay, E. LaBrecque, J.B. Leiness, M. Warden, K. Murray K, and C. Orphanides. 2017. Atlantic Marine Assessment Program for Protected

CONSTRUCTION AND OPERATIONS PLAN

References – Section 4 – Site Characterization and Assessment of Impacts

- Species: 2010-2014. Washington, DC: U.S. Department of the Interior, Bureau of Ocean Energy Management, Atlantic OCS Region. OCS Study BOEM 2017-071. 211 pp.
- Petersen, J.K. and T. Malm. 2006. Offshore windmill farms: threats to or possibilities for the marine environment. *Ambio* 35: 75–80.
- Piniak, W.E.D., D.A. Mann, S.C.A. Harm, T.T. Jones, and S.A. Eckert. 2016. Hearing in the Juvenile Green Sea Turtle (*Chelonia mydas*): A Comparison of Underwater and Aerial Hearing Using Auditory Evoked Potentials. *PLoS One* 11(10):e0159711.
- Plotkin, P.T., R.A. Byles, D.C. Rostal, and D.W. Owens. 1995. Independent vs. socially facilitated migrations of the olive ridley, *Lepidochelys olivacea*. *Marine Biology* 122:137–143.
- Popper, A.N., A.D. Hawkins, R.R. Fay, D.A. Mann, S.S. Bartol, T.J. Carlson, S. Coombs, W.T. Ellison, R.L. Gentry, M.B. Halvorsen, S. Løkkeborg, P.H. Rogers, B.L. Southall, D.G. Zeddies, and W.N. Tavolga. 2014. Sound Exposure Guidelines. In: (Eds.), ASA S3/SC1.4 TR-2014 Sound Exposure Guidelines for Fishes and Sea Turtles: A Technical Report prepared by ANSI-Accredited Standards Committee S3/SC1 and registered with ANSI. pp. 33-51.
- Reubens, J.T., U. Braeckman, J. Vanaverbeke, C. Van Colen, S. Degraer, and M. Vincx. 2013. Aggregation at Windmill Artificial Reefs: CPUE of Atlantic Cod (*Gadus morhua*) and Pouting (*Trisopterus luscus*) at Different Habitats in the Belgian Part of the North Sea. *Fisheries Research* 139:28–34.
- Rhode Island Department of Environmental Management (RI DEM). 2011. Rhode Island's Wildlife, Chapter 1. <http://www.dem.ri.gov/programs/bnatres/fishwild/swap/chap1draft.pdf>. Accessed June 2020.
- RI DEM. 2020. Environmental Resource Map: Natural Heritage Area. <http://www.dem.ri.gov/maps/>. Accessed June 2020.
- Richards, P.M., S.P. Epperly, S.S. Heppell, R.T. King, C.R. Sasso, F. Moncada, G. Nodarse, D.J. Shaver, Y. Medina, and J. Zurita. 2011. Sea turtle population estimates incorporating uncertainty: a new approach applied to western North Atlantic loggerheads *Caretta*. *Endangered Species Research* 15: 151-158.
- Roberts, J.J., B.D. Best, L. Mannocci, E. Fujioka, P.N. Halpin, D.L. Palka, L.P. Garrison, K.D. Mullin, T.V.N. Cole, C.B. Khan, W.M. McLellan, D.A. Pabst, and G.G. Lockhart. 2016a. Habitat-based cetacean Construction and Operations Plan density models for the U.S. Atlantic and Gulf of Mexico. *Scientific Reports* 6: 22615. doi:10.1038/srep22615.
- Roberts, J.J., L. Mannocci, and P.N. Halpin. 2016b. Final Project Report: Marine Species Density Data Gap Assessments and Update for the AFTT Study Area, 2015-2016 (Base Year). Document version 1.0. Report prepared for Naval Facilities Engineering Command, Atlantic by the Duke University Marine Geospatial Ecology Lab, Durham, NC.
- Roberts, J.J., L. Mannocci, R.S. Schick, and P.N. Halpin. 2018. Final Project Report: Marine Species Density Data Gap Assessments and Update for the AFTT Study Area, 2017-2018 (Opt. Year 2). Document version 1.2. Report prepared for Naval Facilities Engineering Command, Atlantic by the Duke University Marine Geospatial Ecology Lab, Durham, NC.

CONSTRUCTION AND OPERATIONS PLAN

References – Section 4 – Site Characterization and Assessment of Impacts

- Sea Turtle Conservancy. 2020a. Information About Sea Turtles: Leatherback Sea Turtle. <https://conserveturtles.org/information-about-sea-turtles-leatherback-sea-turtle/>. Accessed July 2020.
- Sea Turtle Conservancy. 2020b. Information About Sea Turtles: Loggerhead Sea Turtle. <https://conserveturtles.org/information-sea-turtles-loggerhead-sea-turtle/>. Accessed July 2020.
- Sea Turtle Conservancy. 2020c. Information About Sea Turtles: Kemp's Ridley Sea Turtle. <https://conserveturtles.org/information-about-sea-turtles-kemps-ridley-sea-turtle/>. Accessed July 2020.
- Sea Turtle Conservancy. 2020d. Information About Sea Turtles: Green Sea Turtle. <https://conserveturtles.org/information-sea-turtles-green-sea-turtle/>. Accessed July 2020.
- Seminoff, J.A., C.D. Allen, G.H. Balazs, P.H. Dutton, T. Eguchi, H.L. Haas, S.A. Hargrove, M. Jensen, D.L. Klemm, A.M. Lauritsen, S.L. MacPherson, P. Opay, E.E. Possardt, S. Pultz, E. Seney, K.S. Van Houtan, and R.S. Waples. 2015. Status Review of the Green Turtle (*Chelonia mydas*) under the *Endangered Species Act*. NAA Technical Memorandum NOAA-TM-NMFS-SWFSC-539. [file:///C:/Users/ewitherington/Downloads/noaa_4922_DS1%20\(1\).pdf](file:///C:/Users/ewitherington/Downloads/noaa_4922_DS1%20(1).pdf). Accessed July 2020.
- Shoop, C.R. and R.D. Kenney. 1992. Seasonal distributions and abundances of loggerhead and leatherback sea turtles in waters of the northeastern United States. *Herpetological Monographs* 43-67.
- Silva, J.M. 2006. EMF Study: Long Island Power Authority (LIPA), Offshore Wind Project. 77 pp.
- Smultea Environmental Sciences, LLC. 2019. Protected Species Observer Technical Report MAW01 Geotechnical Survey Bay State Wind Massachusetts (2019). Lease Area OCS-A 0500.
- Smultea Environmental Sciences, LLC. 2020. Protected Species Observer Technical Report for the Orsted Sunrise Wind Project, BOEM Lease Areas OCS-A 0487/0500, Offshore New York, 2019-2020.
- Snyder, D.B., W.H. Bailey, K. Palmquist, B.R.T. Cotts, and K.R. Olsen. 2019. Evaluation of Potential EMF Effects on Fish Species of Commercial or Recreational Fishing Importance in Southern New England. OCS Study BOEM 2019-049. https://espi.boem.gov/final%20reports/BOEM_2019-049.pdf. Accessed August 2020.
- State of the World's Sea Turtles (SWOT). 2020. Report Volume XV. https://static1.squarespace.com/static/5b80290bee1759a50e3a86b3/t/5e8ca4e3410a9c4efa5232e1/1586275587511/SWOT15_2020.pdf. Accessed July 2020.
- Tetra Tech and LGL. 2020. Final Comprehensive Report for New York Bight Whale Monitoring Aerial Surveys, March 2017 – February 2020. Technical Report prepared by Tetra Tech, Inc. and LGL Ecological Research Associates, Inc. 211 pp. + appendices. Prepared for New York State Department of Environmental Conservation, Division of Marine Resources, East Setauket, NY. May 18, 2020.

CONSTRUCTION AND OPERATIONS PLAN

References – Section 4 – Site Characterization and Assessment of Impacts

- Thomsen, F., K. Lüdemann, R. Kafemann, and W. Piper. 2006. Effects of offshore wind farm noise on marine mammals and fish. biola, Hamurg, Germany on behalf of COWRIE Ltd. 62 p.
- Turtle Expert Working Group (TEWG). 2007. An Assessment of the Leatherback Turtle Population in the Atlantic Ocean. NOAA Technical Memorandum NMFS-SEFSC-555. <https://www.nrc.gov/docs/ML1409/ML14094A407.pdf>. Accessed July 2020.
- United States Army Corps of Engineers (USACE). 2020. South Atlantic Regional Biological Opinion for Dredging and Material Placement Activities in the Southeast United States. 646 pp. <https://www.fisheries.noaa.gov/content/endangered-species-act-section-7-biological-opinions-southeast>. Accessed June 2020.
- United States Fish & Wildlife Service (USFWS). 2013. Leatherback Sea Turtle (*Dermochelys coriacea*) 5-Year Review: Summary and Evaluation. https://ecos.fws.gov/docs/five_year_review/doc4313.pdf. Accessed July 2020.
- United States Geological Survey (USGS). 2014. East Coast Sediment Texture Database (2014): Open-File Report 2005-1001. U.S. Geological Survey, Coastal and Marine Geology Program, Woods Hole Coastal and Marine Science Center, Woods Hole, MA.
- Waring, G.T., S.A. Wood, and E. Josephson. 2012. Literature search and data synthesis for marine mammals and sea turtles in the U.S. Atlantic from Maine to the Florida Keys. U.S. Dept. of the Interior, Bureau of Ocean Energy Management, Gulf of Mexico OCS Region, New Orleans, LA. OCS Study BOEM 2012-109. 456 pp.
- Wilhelmsson, D., T. Malm, and M.C. Öhman. 2006. The Influence of Offshore Windpower on Demersal Fish. ICES Journal of Marine Science 63 (5):775–784. doi: 10.1016/j.icesjms.2006.02.001.
- Witt, M.J., L.A. Hawkes, M.H. Godfrey, B.J. Godley, and A.C. Broderick. 2010. Predicting the Impacts of Climate Change on a Globally Distributed Species: The Case of the Loggerhead Turtle. The Journal of Experimental Biology 213: 901- 911.
- Work, P.A., A.L. Sapp, D.W. Scott, and M.G. Dodd. 2010. Influence of Small Vessel Operation and Propulsion System on loggerhead Sea Turtle Injuries. Journal of Experimental Marine Biology and Ecology 393 (2010):168–175.

5.4.4.6 Avian Species

- Baker, A., P. Gonzalez, R.I.G. Morrison, and B.A. Harrington. 2013. Red Knot (*Calidris canutus*). In The Birds of North America (P. G. Rodewald, Editor). Cornell Lab of Ornithology, Ithaca, NY.
- Bay State Wind. 2019. Construction and Operations Plan, Volume II: Site Characterization and Assessment of Impact-Producing Factors and List of References. Submitted to BOEM March 15, 2019, Revised June 28, 2019.
- Biodiversity Research Institute (BRI). 2019. Assessment of the Potential Effects of the Revolution Wind Farm on Birds & Bats: Lease Area OCS-A-0486. Prepared for DWW Rev I, LLC. Biodiversity Research Institute, Portland, ME. 145 pp. + maps.

CONSTRUCTION AND OPERATIONS PLAN

References – Section 4 – Site Characterization and Assessment of Impacts

- Bordage, D., and J.L. Savard. 2020. Black Scoter (*Melanitta americana*), version 2.0. In The Birds of North America (A. F. Poole, Editor). Cornell Lab of Ornithology, Ithaca, NY, USA. Available online: <https://doi.org/10.2173/bna.177>.
- Bottalico, P., D. Spongiant, C.A. Bertetti, M. Falossi. 2015. Effect of Noise Generated by Construction Sites on Birds. Inter Noise (Conference). San Francisco, CA, USA. August 9-12, 2015.
- Buehler, D.A. 2000. Bald Eagle (*Haliaeetus leucocephalus*). In The Birds of North America, No. 506 (A. Poole and F. Gill, eds.). The Birds of North America Inc., Philadelphia, PA.
- Burger, J., C. Gordon, J. Lawrence, J. Newman, G. Forcey, and L. Vlietstra. 2011. Risk evaluation for federally listed (roseate tern, piping plover) or candidate (red knot) bird species in offshore waters: A first step for managing the potential impacts of wind facility development on the Atlantic Outer Continental Shelf. *Renewable Energy* 36: 338–351.
- Burger, J., L.J. Niles, R.R. Porter, A.D. Dey, S. Koch, and C. Gordon. 2012. Using a shore bird (red knot) fitted with geolocators to evaluate a conceptual risk model focusing on offshore wind. *Renewable Energy* 43: 370-377.
- Burger, J. 2015. Laughing Gull (*Leucophaeus atricilla*). In The Birds of North America (P. G. Rodewald, Ed.). Cornell Lab of Ornithology, Ithaca, NY.
- Bureau of Ocean Energy Management (BOEM). 2014. Commercial Wind Lease Issuance and Site Assessment Activities on the Atlantic Outer Continental Shelf Offshore Massachusetts: Revised Environmental Assessment. OCS EIS/EA BOEM 2014-603. U.S. Department of the Interior, Bureau of Ocean Energy Management, Herndon, VA. 674 pp.
- BOEM. 2016. Commercial Wind Lease Issuance and Site Assessment Activities on the Atlantic Outer Continental Shelf Offshore New York: Revised Environmental Assessment. OCS EIS/EA BOEM 2016-070. U.S. Department of the Interior, Bureau of Ocean Energy Management, Sterling, VA.
- BOEM. 2020. Guidelines for Providing Avian Survey Information for Renewable Energy Development on the Outer Continental Shelf Pursuant to 30 CFR Part 585. May 27, 2020.
- Carboneras, C., F. Jutglar, G. M. Kirwan, and C.J. Sharpe. 2020. Flesh-footed Shearwater (*Ardenna carneipes*), version 1.0. In Birds of the World (J. del Hoyo, A. Elliott, J. Sargatal, D. A. Christie, and E. de Juana, Editors). Cornell Lab of Ornithology, Ithaca, NY, USA. <https://doi.org/10.2173/bow.flfshe.01>.
- Cook, A.S. C.P., A. Johnston, L.J. Wright, and N.H.K. Burton. 2012. A Review of Flight Heights and Avoidance Rates of Birds in Relation to Offshore Wind Farms. BTO Research Report Number 618. British Trust for Ornithology, Thetford, UK. 61 pp.
- Cook, A.S. C.P., E.M. Humphreys, F. Bennet, E.A. Masden, and N.H.K. Burton. 2018. Quantifying avian avoidance of offshore wind turbines: Current evidence and key knowledge gaps. *Marine Environmental Research* 140: 278–288.
- Curtice, C., J. Cleary, E. Shumchenia, and P.N. Halpin. 2019. Marine-life Data and Analysis Team (MDAT) technical report on the methods and development of marine-life data to support regional ocean planning and management.

CONSTRUCTION AND OPERATIONS PLAN

References – Section 4 – Site Characterization and Assessment of Impacts

- http://seamap.env.duke.edu/models/MDAT/MDAT-Technical-Report-v1_1.pdf. Accessed August 7, 2019.
- Dierschke, V., R.W. Furness, and S. Garthe. 2016. Seabirds and offshore wind farms in European waters: Avoidance and attraction. *Biological Conservation* 202: 59–68.
- Drewitt, A.L., and R.H.W. Langston. 2006. Assessing the impacts of wind farms on birds. *Ibis* 148: 29–42.
- Dorr, B. S., J.J. Hatch, and D.V. Weseloh. 2020. Double-crested Cormorant (*Phalacrocorax auritus*), version 1.0. In *Birds of the World* (A. F. Poole, Editor). Cornell Lab of Ornithology, Ithaca, NY, USA. <https://doi.org/10.2173/bow.doccor.01>.
- Drucker, J., C. Carboneras, F. Jutglar, and G. M. Kirwan. 2020. Wilson's Storm-Petrel (*Oceanites oceanicus*), version 1.0. In *Birds of the World* (S. M. Billerman, Editor). Cornell Lab of Ornithology, Ithaca, NY, USA. <https://doi.org/10.2173/bow.wispet.01>.
- Elliott-Smith, E., and S. M. Haig. 2004. Piping Plover (*Charadrius melodus*). In *The Birds of North America* (P. G. Rodewald, Editor). Cornell Lab of Ornithology, Ithaca, NY.
- Fox, A.D., M. Desholm, J. Kahlert, T. K. Christensen, and I. K. Petersen. 2006. Information needs to support environmental impact assessment of the effects of European marine offshore wind farms on birds. *Ibis* 148: 129–144.
- Fox, A.D., and I.K. Petersen. 2019. Offshore wind farms and their effects on birds. *Dansk Ornithologisk Forenings Tidsskrift*. 113: 86–101.
- Furness, R.W. and P. Monaghan. 1987. *Seabird Ecology*. Blackie, New York, NY. 173 pp.
- Furness, R.W., H.M. Wade, and E.A. Masden. 2013. Assessing vulnerability of marine bird populations to offshore wind farms. *Journal of Environmental Management* 119: 56–66.
- Garthe, S., and O. Hüppop. 2004. Scaling possible adverse effects of marine wind farms on seabirds: developing and applying a vulnerability index. *Journal of Applied Ecology* 41: 724–734.
- Garthe, S., N. Markones, and A.M. Corman. 2017. Possible impacts of offshore wind farms on seabirds: a pilot study in Northern Gannets in the southern North Sea. *Journal of Ornithology* 158: 345–349.
- Gaston, A.J. 2004. *Seabirds: a Natural History*. Yale University Press, New Haven, CT. 222 pp.
- Gauthreaux, Sidney A. JR. 1991. The Flight Behavior of Migrating Birds in Changing Wind Fields: Radar and Visual Analyses. *AMER. ZOOLOG.*, 31:187-204.
- Good, T.P. 1998. Great Black-backed Gull (*Larus marinus*). In *The Birds of North America* (A.F. Poole and F.B Gill, Editor). Cornell Lab of Ornithology, Ithaca, NY.
- Goodale, M.W., and A. Milman. 2016. Cumulative adverse effects of offshore wind energy development on wildlife. *Journal of Environmental Planning and Management* 59: 1–21.
- Goudie, R.I., G.J. Robertson, and A. Reed. 2000. Common Eider (*Somateria mollissima*), version 2.0. In *The Birds of North America* (A. F. Poole and F. B. Gill, Editors). Cornell Lab of Ornithology, Ithaca, NY, USA. Available online: <https://doi.org/10.2173/bna.546>.

CONSTRUCTION AND OPERATIONS PLAN

References – Section 4 – Site Characterization and Assessment of Impacts

- Haney, J.C. 1987. Aspects of the pelagic ecology and behavior of the Black-capped Petrel (*Pterodroma hasitata*). *Wilson Bulletin* 99: 153–168.
- Hartman, J.C., K.L. Krijgsveld, M.J.M. Poot, R.C. Fijn, M.F. Leopold, and S. Dirksen. 2012. Effects on birds of Offshore Wind farm Egmond aan Zee (OWEZ). An overview and integration of insights obtained. Report 12-005.
- Hill, R., K. Hill, R. Aumuller, A. Schulz, T. Dittmann, C. Kulemeyer, and T. Coppack. 2014. Of birds, blades and barriers: Detecting and analyzing mass migration events at alpha ventus. Pages 111-131. BSH & BMU. Ecological Research at the Offshore Windfarm alpha ventus – Challenges, Results and Perspectives. Federal Maritime and Hydrographic Agency (BSH), Federal Ministry for the Environment, Nature, Conservation, and Nuclear Safety (BMU).
- Hüppop, O., J. Dierschke, K.M. Exo, E. Fredrich, and R. Hill. 2006. Bird migration studies and potential collision risk with offshore wind turbines. *Ibis* 148: 90–109.
- Hüppop, O., B. Michalik, L. Bach, R. Hill, and S.K. Pelletier. In press. Wildlife and Windfarms Conflicts and Solutions Volume 2 Offshore, Pelagic Publishing. Collisions of birds with artificial offshore and near-shore structures and Migrating Birds and Bats – Barriers and Collisions.
- Jennings, Kevin. 2018. Presentation: 2018 Long Island Colonial Waterbird & Piping Plover Update. Harbor Herons & Other Waterbirds of the Greater NY/NJ Harbor Working Group (December 11, 2018). Prepared by New York State Department of Environmental Conservation.
- Jodice, P.G.R., R.A. Ronconi, E. Rupp, G.E. Wallace, and Y. Satgé. 2015. First satellite tracks of the Endangered Black-capped Petrel. *Endangered Species Research* 29: 23–33.
- Kleist, N.J., R.P. Guralnick, A. Cruz, C.A. Lowry, and C.D. Francis. 2018. Chronic anthropogenic noise disrupts glucocorticoid signaling and has multiple effects on fitness in an avian community. *Proceedings of the National Academy of Sciences of the United States of America*. E648–E657.
- Kragefky, S. 2014. Effects of the alpha ventus offshore test site on pelagic fish. Pp. 83-94. BSH & BMU. Ecological Research at the Offshore Windfarm alpha ventus – Challenges, Results and Perspectives. Federal Maritime and Hydrographic Agency (BSH), Federal Ministry for the Environment, Nature, Conservation, and Nuclear Safety (BMU).
- Krijgsveld, K.L., R.C. Fijn, M. Japink, P.W. van Horssen, C. Heunks, M.P. Collier, M.J.M. Poot, D. Beuker, and S. Birksen. 2011. Effect Studies Offshore Wind Farm Egmond aan Zee: Final Report on Fluxes, Flight Altitudes and Behaviour of Flying Birds. NoordZeeWind.
- Krijgsveld, K.L. 2014. Avoidance behaviour of birds around offshore wind farms. Overview of knowledge including effects of configuration. Report Bureau Waardenburg, pp. 13-268.
- Kerlinger, P. 1985. Water-crossing behavior of raptors during migration. *Wilson Bulletin* 97: 109–113.
- Lee, D.S. 2000. Status and Conservation Priorities for Black-capped Petrels in the West Indies. Pp. 11–18 in Status and Conservation of West Indian Seabirds (E.A. Schreiber and D.S. Lee, Editors). Society of Caribbean Ornithology, Ruston, LA.

CONSTRUCTION AND OPERATIONS PLAN

References – Section 4 – Site Characterization and Assessment of Impacts

- Leonhard, S.B., J. Pedersen, P.N. Gron, H. Skov, J. Jansen, C. Topping, and I.K. Petersen. 2013. Wind farms affect common scoter and red-throated diver behaviour. Pp. 70–93 in Danish Offshore Wind: Key Environmental Issues - A Follow-up. The Environment Group: The Danish Energy Agency. The Danish Nature Agency, DONG Energy and Vattenfall.
- Lindeboom, H.J., H.J. Kouwenhoven, M.J.N. Bergman, S. Bouma, S. Brasseur, R. Daan, R.C. Fijn, D. de Haan, S. Dirksen, R. van Hal, R. Hille Ris Lambers, R. ter Hofstede, K.L. Krijgsveld, M. Leopold, and M. Scheidat. 2011. Short-term ecological effects of an offshore wind farm in the Dutch coastal zone; a compilation. *Environmental Research Letters* 6: 035101.
- Loring, P., H. Goyert, C. Griffin, P. Sievert, and P. Paton. 2017a. Tracking Movements of Common Terns, Endangered Roseate Terns, and Threatened Piping Plovers in the Northwest Atlantic. 2017 Annual Report to the Bureau of Ocean Energy Management (BOEM) under Interagency Agreement. No. M13PG00012 to U.S. Fish and Wildlife Service (USFWS) - Northeast Region Division of Migratory Birds. March 31, 2017.
- Loring, P., P.A. Smith, J. McLaren, S. Koch, L. Niles, S. Johnston, C. Spiegel. 2017b. Tracking Movements of Threatened Migratory rufa Red Knots in U.S. Atlantic Outer Continental Shelf Waters. 2017 Annual Report to the Bureau of Ocean Energy Management (BOEM) under Interagency Agreement. No. M13PG00016 to U.S. Fish and Wildlife Service (USFWS) - Northeast Region Division of Migratory Birds. April 28, 2017.
- Loring, P.H., J.D. McLaren, P.A. Smith, L.J. Niles, S.L. Koch, H.F. Goyert, H. Bai. 2018. Tracking movements of threatened migratory rufa Red Knots in U.S. Atlantic Outer Continental Shelf Waters. Sterling (VA): US Department of the Interior, Bureau of Ocean Energy Management. OCS Study BOEM 2018-046. 145 p.
- Loring, P., P.W.C. Paton, J.D. McLaren, H. Bai, R. Janaswamy, H.F. Goyert, C.R. Griffin, P.R. Sievert. 2019. Tracking Offshore Occurrence of Common Terns, Endangered Roseate Terns, and Threatened Piping Plovers with VHF Arrays. Sterling (VA): US Department of the Interior, Bureau of Ocean Energy Management. OCS Study BOEM 2019-017. 140 p.
- Macwhirter, R.B., P. Austin-Smith Jr., and D.E. Kroodsma. 2002. Sanderling (*Calidris alba*). In *The Birds of North America* (A. F. Poole and F. B. Gill, Editors). Cornell Lab of Ornithology, Ithaca, NY.
- Marine Management Organisation (MMO). 2018. Displacement and Habituation of Seabirds in Response to marine activities. MMO Project No: 1139. Marine Management Organisation, Newcastle-Upon-Tyne, UK. 69 pp.
- Massachusetts Division of Fisheries and Wildlife (MDFW). 2015a. Piping Plover, *Charadrius melodus*. <https://www.mass.gov/doc/piping-plover/download>. Accessed May 29, 2020.
- MDFW. 2015b. Roseate Tern, *Sterna dougallii*. <https://www.mass.gov/doc/roseate-tern/download>. Accessed May 29, 2020.
- MDFW. 2020. Red Knot, *Calidris canutus*. <https://www.mass.gov/doc/red-knot/download>. Accessed May 29, 2020.
- Minerals Management Service (MMS). 2008. Cape Wind Energy Project Nantucket Sound Biological Assessment (Appendix G). In Cape Wind Energy Project Final EIS. p. 296.

CONSTRUCTION AND OPERATIONS PLAN

References – Section 4 – Site Characterization and Assessment of Impacts

- Mostello, C.S., I.C.T. Nisbet, S.A. Oswald, and J.W. Fox. 2014. Non-breeding season movements of six North American Roseate Terns (*Sterna dougallii*) tracked with geolocators. *Seabird* 27: 1–21.
- National Park Service (NPS). 2018. Fire Island National Seashore, New York, Threatened and Endangered Species. <https://www.nps.gov/fiis/learn/nature/threatened-and-endangered-species.htm>. Accessed June 29, 2020.
- New York State Breeding Bird Atlas. 2007. 2000 - 2005. Release 1.0. Albany (New York): New York State Department of Environmental Conservation [updated June 11, 2007]. <http://www.dec.ny.gov/animals/7312.html>. Accessed April 14, 2020.
- New York State Energy Research and Development Authority (NYSERDA). 2017a. New York State Offshore Wind Master Plan. Birds and Bats Study. NYSERDA Report 17-25d. 142p.
- NYSERDA. 2017b. New York State Offshore Wind Master Plan. Cable Landfall Permitting Study. NYSERDA Report 17-25e. 248p.
- New York Natural Heritage Program (NYNHP). 2020a. Letter, Re: Sunrise Offshore Wind Farm. March 27, 2020. New York State Department of Environmental Conservation New York State Department of Environmental Conservation (NYSDEC). 2015. List of Endangered, Threatened and Special Concern Fish & Wildlife Species of New York State. <https://www.dec.ny.gov/animals/7494.html>. Accessed March 31, 2020.
- NYNHP. 2020b. Online Conservation Guide for *Haliaeetus leucocephalus*. <https://guides.nynhp.org/bald-eagle/>. Accessed May 29, 2020.
- New York State Department of Environmental Conservation (NYSDEC). 2015a. Species Status Assessment for Roseate Tern. https://www.dec.ny.gov/docs/wildlife_pdf/sgcnroseatetern.pdf. Accessed March 31, 2020.
- NYSDEC. 2015b. Species Status Assessment for Bald Eagle. https://www.dec.ny.gov/docs/wildlife_pdf/sgcnbaldeagle.pdf. Accessed April 3, 2020.
- NYSDEC. 2015c. Species Status Assessment for Piping Plover. https://www.dec.ny.gov/docs/wildlife_pdf/sgcnpippllover.pdf. Accessed April 3, 2020.
- NYSDEC. 2015d. Species Status Assessment for Red Knot. https://www.dec.ny.gov/docs/wildlife_pdf/sgcnredknot.pdf. Accessed March 31, 2020.
- Nisbet, I.C.T. 1984. Migration and winter quarters of North American Roseate Terns as shown by banding recoveries. *Journal of Field Ornithology* 55: 1–17.
- Nisbet, I.C.T., M. Gochfeld, and J. Burger. 2014. Roseate Tern (*Sterna dougallii*). In *The Birds of North America*. (A.F. Poole, Editor). Cornell Lab of Ornithology, Ithaca, NY.
- Nisbet, I.C.T., D.V. Weseloh, C.E. Hebert, M.L. Mallory, A.F. Poole, J.C. Ellis, P. Pyle, and M.A. Patten. 2017. Herring Gull (*Larus argentatus*). In *The Birds of North America* (P. G. Rodewald, Editor). Cornell Lab of Ornithology, Ithaca, NY.
- Nisbet, I. C.T., D.V. Weseloh, C.E. Hebert, M.L. Mallory, A.F. Poole, J.C. Ellis, P. Pyle, and M.A. Patten. 2020. Herring Gull (*Larus argentatus*), version 1.0. In *Birds of the World*

CONSTRUCTION AND OPERATIONS PLAN

References – Section 4 – Site Characterization and Assessment of Impacts

- (S.M. Billerman, Editor). Cornell Lab of Ornithology, Ithaca, NY, USA. <https://doi.org/10.2173/bow.hergul.01>.
- Normandeau and APEM. 2019. Remote Marine and Onshore Technology Digital Aerial Baseline Survey of Marine Wildlife in Support of Offshore Wind Energy. Prepared for New York State Energy Research and Development Authority. https://remote.normandeau.com/portal_data.php?pj=6&public=1
- Ortega, C.P. 2012. Effects of noise pollution on birds: a brief review of our knowledge. *Ornithological Monographs*: 74 (1). pp. 6–22.
- Paton, P., K. Winiarski, C. Trocki, and S. McWilliams. 2010. Spatial Distribution, Abundance, and Flight Ecology of Birds in Nearshore and Offshore Waters of Rhode Island. Interim Technical Report for the Rhode Island Ocean Special Area Management Plan 2010. June 17, 2010.
- Perkins, S., T. Allison, A. Jones, and G. Sadoti. 2004. A Survey of Tern Activity Within Nantucket Sound, Massachusetts During the 2003 Fall Staging Period. Final Report to the Massachusetts Technology Collaborative. Mass Audubon, Lincoln, MA. 25 pp.
- Peters, K.A. and D.L. Otis. 2007. Shorebird roost-site selection at two temporal scales: is human disturbance a factor? *Journal of Applied Ecology* 44. pp. 196–209.
- Peters, K.A. 2008. Avian Inventory and Monitoring Needs for Fire Island National Seashore: A Review of Available Literature and Data. Final Report Submitted to National Park Service.
- Pollet, I.L., D. Shutler, J.W. Chardine, and J.P. Ryder. 2012. Ring-billed Gull (*Larus delawarensis*). In *The Birds of North America* (P. G. Rodewald, Editor). Cornell Lab of Ornithology, Ithaca, NY.
- Rhode Island Natural Heritage Program (RINHP). 2006. Rare Native Animals of Rhode Island. https://rinhs.org/wp-content/uploads/2012/05/ri_rare_animals_2006.pdf. Accessed May 29, 2020.
- Robertson, G.J., and J.L. Savard. 2020. Long-tailed Duck (*Clangula hyemalis*), version 2.0. In *The Birds of North America* (A.F. Poole and F.B. Gill, Editors). Cornell Lab of Ornithology, Ithaca, NY, USA. Available online: <https://doi.org/10.2173/bna.651>.
- Roman, L., B.D. Hardesty, M.A. Hindell, and C. Wilcox. 2019. A quantitative analysis linking seabird mortality and marine debris ingestion. *Scientific Reports* 9: 3202.
- Schrieber, E.A., and J. Burger. 2001. *Biology of Marine Birds*. CRC Press, Boca Raton, FL. 740 pp.
- Simons, T.R., D.S. Lee, and J.C. Hanley. 2013. Diablotin (*Pterodroma hasitata*): A biography of the endangered Black-capped Petrel. *Marine Ornithology* 41: S3–S43.
- Skov, H., S. Heinanen, T. Norman, R.M. Ward, S. Mendez-Roldan, and I. Ellis. 2018. ORJIP Bird Collision and Avoidance Study. Final Report - April 2018. The Carbon Trust, London, UK. 247 pp.
- Tanaka, K., H.R. Takada, Yamashita, K. Mizukawa, M. Fukuwaka, and Y. Watanuki. 2013. Accumulation of plastic-derived chemicals in tissues of seabirds ingesting marine plastics. *Marine Pollution Bulletin* 69: 219–222.

CONSTRUCTION AND OPERATIONS PLAN

References – Section 4 – Site Characterization and Assessment of Impacts

- Teuten, E.L., J.M. Saquing, D.R.U. Knappe, M.A. Barlaz, S. Jonsson, A. Bjorn, S.J. Rowland, R.C. Thompson, T.S. Galloway, R. Yamashita, D. Ochi, Y. Watanuki, C. Moore, P. Hung Viet, T. Seang Tana, M. Prudente, R. Boonyatumanond, M.P. Zakaria, K. Akkhavong, Y. Ogata, H. Hirai, S. Iwasa, K. Mizukawa, Y. Hagino, A. Imamura, M. Saha, and H. Takad. 2009. Transport and release of chemicals from plastics to the environment and to wildlife. *Philos. Trans R Soc B – Biological Sciences* 364: 2027–2045.
- U.S. Army Corp of Engineers (USACE). 2014. Biological Assessment for: Piping Plover (*Charadrius melodus*) and seabeach amaranth (*Amaranthus pumilus*), Fire Island Inlet to Moriches Inlet (FIMI) Federal Stabilization Project. Revised February 2014. https://www.nan.usace.army.mil/Portals/37/docs/civilworks/projects/ny/coast/fimp/FIMI_Docs/EA/Attachment_D2_FIMI%20BA_Final_.pdf. Accessed June 8, 2020.
- U.S. Fish and Wildlife Service (USFWS). 2001. Roseate Tern Habitat Model. [Online]. Available at: http://www.fws.gov/r5gomp/gom/habitatstudy/metadata/roseate_tern_model.htm
- USFWS. 2009. Piping Plover (*Charadrius melodus*) 5-Year Review: Summary and Evaluation. U.S. Fish and Wildlife Service, Hadley, MA, and East Lansing, MI. 214 pp.
- USFWS. 2010. Caribbean Roseate Tern and North Atlantic Roseate Tern (*Sterna dougallii dougallii*) 5-Year Review: Summary and Evaluation. U.S. Fish and Wildlife Service, Boquerón, Puerto Rico, and Concord, NH. 148 pp.
- USFWS. 2019a. Black-capped petrel, *Pterodroma hasitata*. <https://www.fws.gov/southeast/wildlife/birds/black-capped-petrel>. Accessed March 31, 2020.
- USFWS. 2019b. Status of the Species. <https://www.fws.gov/verobeach/StatusoftheSpecies.html>. Accessed May 5, 2020.
- USFWS. 2020. Information for Planning and Consultation, Letter Re: List of threatened and endangered species that may occur in your proposed project location, and/or may be affected by your proposed project. March 11, 2020.
- Vanermen, N., T. Onkelinx, W. Courtens, M. Van de walle, H. Verstraete, and E.W. M. Stienen. 2015. Seabird avoidance and attraction at an offshore wind farm in the Belgian part of the North Sea. *Hydrobiologia* 756: 51–61.
- Veit, R.R. and W.R. Petersen. 1993. Birds of Massachusetts. Massachusetts Audubon Society. 161-162, 233-234.
- Veit, R.R. and S.A. Perkins. 2014. Aerial Surveys for Roseate and Common Terns South of Tuckernuck and Muskeget Islands July-September 2013. US Dept. of the Interior, Bureau of Ocean Energy Management, Office of Renewable Energy Programs, Herndon, VA. OCS Study BOEM 2014-665. 13 pp.
- Veit, R.R., T.P. White, S.A. Perkins, S. Curley. 2016. Abundance and Distribution of Seabirds off Southeastern Massachusetts, 2011-2015. U.S. Department of the Interior, Bureau of Ocean Energy Management, Sterling, Virginia. OCS Study BOEM 2016-067. 82 pp.

CONSTRUCTION AND OPERATIONS PLAN

References – Section 4 – Site Characterization and Assessment of Impacts

- Vlietstra, L.S. 2007. Potential Impact of the Massachusetts Maritime Academy Wind Turbine on Common (*Sterna hirundo*) and Roseate (*S. dougallii*) Terns. OCEANS 2007–Europe, Aberdeen, UK, 2007. pp.1–6.
- Wade, H.M., E.A. Masden, A.C. Jackson, and R.W. Furness. 2016. Incorporating data uncertainty when estimating potential vulnerability of Scottish seabirds to marine renewable energy developments. *Marine Policy* 70: 108–113.
- Williams, K.A., I.J. Stenhouse, E.E. Connelly, and S.M. Johnson. 2015. Mid-Atlantic Wildlife Studies: Distribution and Abundance of Wildlife along the Eastern Seaboard 2012-2014. Science Communications Series BRI 2015-19. Biodiversity Research Institute. Portland, Maine. 32 pp.
- Willmott, J.R., G. Forcey, and A. Kent. 2013. The Relative Vulnerability of Migratory Bird Species to Offshore Wind Energy Projects on the Atlantic Outer Continental Shelf: An Assessment Method and Database. Final Report to the U.S. Department of the Interior, Bureau of Ocean Energy Management, Office of Renewable Energy Programs. OCS Study BOEM 2013-207. 275 pp.
- Winiarski, K, P. Paton, S. McWilliams, and D. Miller. 2012. Rhode Island Ocean Special Area Management Plan: Studies Investigating the Spatial Distribution and Abundance of Marine Birds in Nearshore and Offshore Waters of Rhode Island. Department of Natural Resources Science, University of Rhode Island. October 10, 2012.
- Yamashita, R., H. Takada, M.A. Fukuwaka, and Y. Watanuki. 2011. Physical and chemical effects of ingested plastic debris on Short-tailed Shearwaters (*Puffinus tenuirostris*) in the North Pacific Ocean. *Marine Pollution Bulletin* 62: 2845–2849.

5.4.4.7 Bats

- Ahlén, I. 2006. Risker för fladdermöss med havsbaserad vindkraft. Slutrapport för 2006 till Energimyndigheten. Projektnr 22514-1. [In Swedish with English summary]. Risk assessment for bats at offshore windpower turbines. Final report for 2006 to the Swedish Energy Administration.
- Ahlén I., H.J. Baagøe, L. Bach, and J. Pettersson. 2007. Bats and offshore wind turbines studied in southern Scandinavia. Swedish Environmental Protection Agency.
- Ahlén I., H.J. Baagøe, and L. Bach. 2009. Behavior of Scandinavian bats during migration and foraging at sea. *Journal of Mammalogy* 90:1318-1323.
- Allison, T.D., J.E. Diffendorfer, E.F. Baerwald, J.A. Beston, D. Drake, A.M. Hale, C.D. Hein, M.M. Huso, S.R. Loss, J.E. Lovich, M.D. Strickland, K.A. Williams, and V.L. Winder. 2019. Impacts to wildlife of wind energy siting and operation in the United States. *Issues In Ecology* 21: 1–24.
- Arnett, E.B., W.K. Brown, W.P. Erickson, J.K. Fiedler, B.L. Hamilton, T.H. Henry, A. Jain, G.D. Johnson, J. Kerns, R.R. Koford, C.P. Nicholson, T.J. O’Connell, M.D. Piorkowski, and R.D. Tamkersley. 2008. Patterns of bat fatalities at wind energy facilities in North America. *Journal of Wildlife Management* 72: 61–78.

CONSTRUCTION AND OPERATIONS PLAN

References – Section 4 – Site Characterization and Assessment of Impacts

- Bat Conservation International. 2001. Bats in Eastern Woodlands. Produced by Bat Conservation International, United States Department of the Agriculture-Forest Service, United States Department of the Interior-US Fish and Wildlife Service, and National Council for Air and Stream Improvement. 197 pp + appendices.
- Bureau of Ocean Energy Management (BOEM). 2012. Commercial Wind Lease Issuance and Site Characterization Activities on the Atlantic Outer Continental Shelf Offshore New Jersey, Delaware, Maryland, and Virginia Draft Environmental Assessment. OCS EIS/EA BOEMRE 2011-037. Department of the Interior, Bureau of Ocean Energy Management, Herndon, VA. 246 pp.
- BOEM. 2013. Information synthesis on the potential for bat interactions with offshore wind facilities. OCS Study BOEM 2013-01163. U.S. Department of the Interior, Bureau of Ocean Energy Management, Herndon, VA. 112 pp.
- BOEM. 2014. Commercial Wind Lease Issuance and Site Assessment Activities on the Atlantic Outer Continental Shelf Offshore Massachusetts: Revised Environmental Assessment. OCS EIS/EA BOEM 2014-603. U.S. Department of the Interior, Bureau of Ocean Energy Management, Herndon, VA. 674 pp.
- BOEM. 2019. Vineyard Wind Offshore Wind Energy Project Biological Assessment: Final. U.S. Department of the Interior, Bureau of Ocean Energy Management, Sterling, VA. 55 pp.
- Cryan, P.M. 2008. Mating behavior as a possible cause of bat fatalities at wind turbines. *Journal of Wildlife Management* 72: 845–849.
- Cryan, P.M. and R.M.R. Barclay. 2009. Causes of bat fatalities at wind turbines: Hypotheses and predictions. *Journal of Mammalogy* 90: 1330–1340.
- Cryan, P.M., P.M. Gorresen, C.D. Hein, M.R. Schirmacher, R.H. Diehl, M.M. Huso, D.T. Hayman, P.D. Fricker, F.J. Bonaccorso, D.H. Johnson, and K. Heist. 2014. Behavior of bats at wind turbines. *Proceedings of the National Academy of Science* 111: 15126–15131.
- Davies, T.W., J. Bennie, K.J. Gaston. 2012. Street lighting changes the composition of invertebrate communities. *Biol. Lett.* 8, 764–767.
- Dowling, Z., P.R. Sievert, E. Baldwin, L. Johnson, S. von Oettingen, and J. Reichard. 2017. Flight Activity and Offshore Movements of Nano-Tagged Bats on Martha's Vineyard, MA. OCS Study BOEM 2017-054. U.S. Department of the Interior, Bureau of Ocean Energy Management, Sterling, VA. 39 pp.
- Dowling, Z.R., and D.I. O'Dell. 2018. Bat use of an island off the coast of Massachusetts. *Northeastern Naturalist* 25: 362–382.
- Geiser, F. 2004. Metabolic rate and body temperature reduction during hibernation and daily torpor. *Annu. Rev. Physiol.* 66, 239-274.
- Gruver, J. and L. Bishop-Boros. 2015. Summary and synthesis of myotis fatalities at wind facilities with a focus on northeastern North America. EDP Renewables North America, Houston, Texas, USA.

CONSTRUCTION AND OPERATIONS PLAN

References – Section 4 – Site Characterization and Assessment of Impacts

- Hatch, S.K., E.E. Connelly, T.J. Divoll, I.J. Stenhouse, and K.A. Williams. 2013. Offshore observations of eastern red bats (*Lasiurus borealis*) in the Mid-Atlantic United States using multiple survey methods. *PLoS ONE* 8: e83803.
- Hayes, M.A. 2013. Bats killed in large numbers at United States wind energy facilities. *BioScience* 63: 975–979.
- Hutterer, R., T. Ivanova, C. Meyer-Cords, and L. Rodrigues. 2005. Bat migrations in Europe: a review of banding data and literature. *Naturschutz und Biologische Vielfalt* 28:1-172.
- King, A. 2019. A few beneficial forest management practices (BFMPs) for bats. *Indiana Woodland Steward* Vol. 28:2. Available at: <http://www.inwoodlands.org/-beneficial-forest-manage-bats/>.
- Kunz, T.H. 1982. *Lasionycteris noctivagans*. American Society of Mammalogists. *Mammalian Species*. 172:1–5.
- Kunz, T.H., E.B. Arnett, B.M. Cooper, R.P. Larkin, T. Mabee, M.L. Morrison, M.D. Strickland, and J.M. Szewczak. 2007. Assessing impacts of wind-energy development on nocturnally active birds and bats: A guidance document. 71: 2449–2486.
- Lintott, P.R., N. Bunnefeld, K.J. Park. 2015. Opportunities for improving the foraging potential of urban waterways for bats. *Biological Conservation* 191:224-233.
- Luo, J., B.M. Clarin, I.M. Borissov, B.M. Siemers. 2014. Are torpid bats immune to anthropogenic noise? *Journal of Experimental Biology* 217: 1072-1078.
- Manville II, A.M. 2016. Chapter 20: Impacts to Birds and Bats due to Collisions and Electrocutions from Tall Structures in the United States: Wires, Towers, Turbines, and Solar Arrays - State of the Art in Addressing the Problems. (F.M. Anelicii, Editor). *Problematic Wildlife*. DOI 10.1007/978-3-319-22246-2_20.
- Martin, C.M., E.B. Arnett, R.D. Stevens, and M.C. Wallace. 2017. Reducing bat fatalities at wind facilities while improving the economic efficiency of operational mitigation. *Journal of Mammalogy* 98: 378–385.
- Maslo, B. and K. Leu. 2013. The Facts About Bats in New Jersey [Online]. <https://njaes.rutgers.edu/fs1207/>.
- National Park Service (NPS). 2018. Fire Island National Seashore Bat Population Monitoring and White-nose Syndrome. October 2018.
- NPS. 2019. Bat Population Monitoring at Fire Island National Seashore. <https://www.nps.gov/articles/fiis-bat-monitoring.htm>. Accessed June 8, 2020.
- NPS. 2020. National Park Service Research Permit and Reporting System. <https://irma.nps.gov/RPRS/IAR/Search>. Accessed June 4, 2020.
- Nelson, J.J., E.H. Gillam. 2017. Selection of foraging habitat by female little brown bats (*Myotis lucifugus*). *Journal of Mammalogy* 98(1):222-231.
- New York Department of Environmental Conservation (NYSDEC). n.d.-a. Bats of New York. https://www.dec.ny.gov/docs/administration_pdf/batsofny.pdf

CONSTRUCTION AND OPERATIONS PLAN

References – Section 4 – Site Characterization and Assessment of Impacts

- NYSDEC. n.d.-b. Protection of Northern Long-eared Bats.
<https://www.dec.ny.gov/animals/106090.html>.
- New York Natural Heritage Program (NYNHP). 2020. Letter, Re: Sunrise Offshore Wind Farm. March 27, 2020. New York State Department of Environmental Conservation.
- New York State Energy Research and Development Authority (NYSERDA). 2017a. New York State Offshore Wind Master Plan. Birds and Bats Study. NYSERDA Report 17-25d. 142p.
- NYSERDA. 2017b. New York State Offshore Wind Master Plan. Cable Landfall Permitting Study. NYSERDA Report 17-25e. 248p.
- Peterson, T.S., S.K. Pelletier, S.A. Boyden, and K.S. Watrous. 2014. Offshore acoustic monitoring of bats in the Gulf of Maine. *Northeastern Naturalist* 21: 154–163.
- Pettit, J.L. and J.M. O'Keefe. 2017. Day of year, temperature, wind, and precipitation predict timing of bat migration. *Journal of Mammalogy* 98: 1236–1248.
- Polak, T., C. Korine, S. Yair, M.W. Holderied. 2011. Differential effects of artificial lighting on flight and foraging behaviour of two sympatric bat species in a desert. *J. Zool.* 285, 21–27.
- Potenza, A. 2017. Bats crash into buildings because smooth surfaces trick their echolocation. *The Verge*. <https://www.theverge.com/2017/9/8/16273908/bats-echolocation-buildings-crashes>.
- Rydell, J. and A. Wickman. 2015. Bat Activity at a Small Wind Turbine in the Baltic Sea. *Acta Chiropterologica* 17: 359–364.
- Schaub, A., J. Ostwald, B.M. Siemers. 2008. Foraging bats avoid noise. *Journal of Experimental Biology* 211: 3174–3180.
- Schnitzler, H.U., C.F. Moss, and A. Denzinger. 2003. From spatial orientation to food acquisition in echolocating bats. *Trends in Ecology and Evolution* 18(8). pp. 386–394.
- Shump, K.A., Jr. and A.U. Shump. 1982a. *Lasiurus cinereus*. American Society of Mammalogists. *Mammalian Species*. 185:1–5.
- Shump, K.A., Jr. and A.U. Shump. 1982b. *Lasiurus borealis*. American Society of Mammalogists. *Mammalian Species*. 183:1–6.
- Sjollema, A.L., J.E. Gates, R.H. Hilderbrand, and J. Sherwell. 2014. Offshore activity of bats along the mid-Atlantic coast. *Northeastern Naturalist* 21: 154–163.
- Smallwood, K.S. 2013. Comparing bird and bat fatality-rate estimates among North American wind-energy projects. *Wildlife Society Bulletin* 37: 19–33.
- Smith, A.D. and S.R. McWilliams. 2016. Bat activity during autumn relates to atmospheric conditions: implications for coastal wind energy development. *Journal of Mammalogy* 97(6): 1565–1577.
- Speakman, J.R. and D.W. Thomas. 2003. Physiological ecology and energetics of bats. In *Bat Ecology* (ed. T. H. Kunz and M. B. Fenton), pp. 430–490. Chicago, IL: University of Chicago Press.

CONSTRUCTION AND OPERATIONS PLAN

References – Section 4 – Site Characterization and Assessment of Impacts

- Stantec Consulting Services Inc. (Stantec). 2016a. Vessel-based Acoustic Bat Monitoring: Block Island Wind Farm, Rhode Island. Prepared for: Deepwater Wind Block Island, LLC. October 5, 2016.
- Stantec. 2016b. Long-term Bat Monitoring on Islands, Offshore Structures, and Coastal Sites in the Gulf of Maine, mid-Atlantic, and Great Lakes—Final Report Prepared for: US Department of Energy. Prepared by Stantec Consulting Services Inc. 68 pp + appendices.
- Stantec. 2018a. Vessel-based Acoustic Bat Monitoring: South Fork Wind Farm and South Fork Export Cable. Prepared for: Deepwater Wind Block Island, LLC. March 19, 2018.
- Stantec. 2018b. 2017 Acoustic Monitoring: Block Island Wind Farm, Rhode Island. Prepared for: Deepwater Wind Block Island, LLC. March 19, 2018.
- Stantec 2018c. Long Island Roost Study: Northern Long-eared Bats. Prepared for Cassadaga Wind LLC. August 22, 2018. 21 pp + appendices.
- Stantec. 2018d. Avian and Bat Risk Assessment: South Fork Wind Farm and South Fork Export Cable. Prepared for: Deepwater Wind South Fork, LLC. Stantec Consulting Services, Inc., Topsham, ME.
- Stantec. 2019a. Seacor Supporter Vessel-Based Acoustic Bat Monitoring. South Fork Wind Farm. Prepared for: Deepwater Wind South Fork, LLC. April 22, 2019.
- Stantec. 2019b. Fugro Discovery Vessel-Based Acoustic Bat Monitoring. South Fork Wind Farm. Prepared for: Deepwater Wind South Fork, LLC. April 22, 2019.
- Stantec. 2019c. Conti Vessel-Based Acoustic Bat Monitoring. South Fork Wind Farm. Prepared for: Deepwater Wind South Fork, LLC. April 22, 2019.
- Stantec. 2020a. Fugro Discovery Vessel-based Acoustic Bat Survey Sunrise Wind Farm. Prepared for Sunrise Wind LLC.
- Stantec. 2020b. 2019 Fugro Discovery Vessel-based Acoustic Bat Survey Revolution Wind Farm. Prepared for Revolution Wind, LLC.
- Stantec. 2020c. Fugro Enterprise and Fugro Searcher Vessel-Based Acoustic Bat Survey Sunrise Wind Farm. Prepared for Sunrise Wind LLC.
- United States Fish and Wildlife Service (USFWS). 2016. Field Notes Entry: Bat Monitoring on Long Island Refuges. <https://www.fws.gov/fieldnotes/regmap.cfm?arskey=37191>. Accessed June 4, 2020.
- USFWS. 2020a. Range-wide Indiana Bat (and Northern-long Eared Bat) Survey Guidelines. March 20, 2020. 11 pp + appendices.
- USFWS. 2020b. Information for Planning and Consultation, Letter Re: List of threatened and endangered species that may occur in your proposed project location, and/or may be affected by your proposed project. March 11, 2020.
- USFWS. n.d. Environmental Conservation Online System, Species by County Report, Counties: Nassau and Suffolk, New York. Available at <https://ecos.fws.gov/ecp0/reports/species-by-current-range-county?fips=36059>. Accessed on 4/8/2020.

CONSTRUCTION AND OPERATIONS PLAN

References – Section 4 – Site Characterization and Assessment of Impacts

Verboom, B. 1998. The use of edge habitats by commuting and foraging bats. Agricultural University. Promotor(en): H.H.T. Prins; J. Veen. - Wageningen : IBN-DLO - ISBN 9789054858386 - 123 (dissertation).

5.4.5 Visual Resources

5.4.5.1 Visual Resources

Bureau of Ocean Energy Management (BOEM). 2020. Information Guidelines for a Renewable Energy Construction and Operations Plan (COP). U.S. Government Printing Office. 2020. Herndon, VA.

BOEM. 2021. Guidelines for Lighting and Marking of Structures Supporting Renewable Energy Development. Available online at: <https://www.boem.gov/2021-lighting-and-marking-guidelines>. Accessed May 25, 2021.

Bishop, I.D. 2002. Determination of Thresholds of Visual Impact: The Case of Wind Turbines. Environmental and Planning B: Planning and Design (29) 707-718.

New York State Department of Environmental Conservation (NYSDEC). 2019. Program Policy: Assessing and Mitigating Visual Impacts. DEP-00-2. Division of Environmental Permits, Albany, NY.

Smardon, R.C., J.F. Palmer, A. Knopf, K. Grinde, J.E. Henderson, and L.D. Peyman-Dove. 1988. Visual Resources Assessment Procedure for U.S. Army Corps of Engineers. Instruction Report EL-88-1. Department of the Army, U.S. Army Corps of Engineers. Washington, D.C.

United States Department of Agriculture (USDA), Forest Service. 1995. Landscape Aesthetics: A Handbook for Scenery Management. Agricultural Handbook No. 701. Washington, D.C.

United States Department of the Interior, Bureau of Land Management. 1984. Visual Resource Management Program. U.S. Government Printing Office. 1980. 0-302-993. Washington, D.C.

5.4.6 Cultural Resources

5.4.6.1 Marine Archaeological Resources

Bureau of Ocean Energy Management (BOEM). 2020. Guidelines for Providing Geophysical, Geotechnical, and Geohazard Information Pursuant to 30 CFR Part 585. United States Department of the Interior, Bureau of Ocean Energy Management, Office of Renewable Energy Programs, Washington, D.C.

Merwin, Daria E. 2010. Submerged Evidence of Early Human Occupation in the New York Bight. Ph. D. Dissertation, Department of Anthropology, State University of New York, Stony Brook.

National Centers for Environmental Information (NCEI), Office of Coast Survey, NOAA National Ocean Service. 2020. National Ocean Service Hydrographic Database and Hydrographic Survey Meta Data Base. Electronic database, <https://www.ngdc.noaa.gov/mgg/bathymetry/hydro.html>.

CONSTRUCTION AND OPERATIONS PLAN

References – Section 4 – Site Characterization and Assessment of Impacts

- Poppe, L.J., R.N. Oldale, D.S. Foster., and S.M. Smith. 2012. Glaciotectonic Deformation Associated with the Orient Point–Fishers Island Moraine, Westernmost Block Island Sound: Further Evidence of Readvance of the Laurentide Ice Sheet. *Geo-Mar Lett* 32, 279–288 (2012). <https://doi.org/10.1007/s00367-012-0296-9>.
- Ritchie, W.A. and R. Funk. 1973. Aboriginal Settlement Patterns in the Northeast. New York State Museum & Science Service Memoir 20. State University of New York at Albany.
- TRC Environmental Corporation (TRC). 2012. Inventory and analysis of archaeological site occurrence on the Atlantic outer continental shelf. U.S. Dept. of the Interior, Bureau of Ocean Energy, Gulf of Mexico OCS Region, New Orleans, Louisiana. OCS Study BOEM 2012-008, Washington, D.C.

5.4.6.2 Terrestrial Archaeological Resources

- Bureau of Ocean Energy Management (BOEM). 2020. Guidelines for Providing Archaeological and Historic Property Information Pursuant to 30 CFR Part 585. Bureau of Ocean Energy Management, Washington, DC.
- Chrysalis Archaeological Consultants, Inc. 2018. Phase IB Field Test Report, Forge River Watershed Sewer Project, Town of Brookhaven, (Suffolk County), New York. Report prepared for Governor's Office of Storm Recovery by Chrysalis Archaeological Consultants, Brooklyn, NY.
- Gray & Pape, Inc. (GP). 2005. Archaeological Overview and Assessment of the Fire Island National Seashore, Suffolk County, New York. Report prepared for Vector Resources, Inc. by GP, Richmond, VA.
- Louis Berger Group. 2016. Phase IA Archaeological Sensitivity Assessment, Forge River Watershed Sewer Project, Town of Brookhaven, Suffolk County, New York. Report prepared for Governor's Office of Storm Recovery by Louis Berger Group, Albany, NY.
- New York Archaeological Council (NYAC). 1994. Standards for Cultural Resources Investigations and the Curation of Archaeological Collections in New York State. New York State Office of Parks, Recreation & Historic Preservation, Waterford, NY.
- New York State Historic Preservation Office (NYSHPO). 2005. New York State Historic Preservation Office Phase I Archaeological Report Format Requirements. NYSHPO, Waterford, NY.
- New York State Museum (NYSM). 2010. Cultural Resources Reconnaissance Survey Report, PIN 0059.08, NYS Route 27 from NYS Route 112 to Wading River Road, Town of Brookhaven, Suffolk County, New York, Volume I: Archaeological Reconnaissance Survey. Report prepared for NYSDOT by NYSM, Albany NY.
- Old South Haven Presbyterian Church. 2012. The History of the Old South Haven Church. Old South Haven Presbyterian Church, Brookhaven, NY. <http://oldsouthhavenchurch.org/history/history.htm>. Accessed April 2020.
- Panamerican Consultants, Inc. 1999. Remote Sensing Survey, Tidal Zone and Near Shore Project Area, Atlantic Coast of Long Island, Fire Island Inlet to Moriches Inlet, Fire Island, Suffolk County, New York, Interim Project, Draft Report. Report prepared for U.S. Army Corps of Engineers by Panamerican Consultants, Inc., Memphis TN.

CONSTRUCTION AND OPERATIONS PLAN

References – Section 4 – Site Characterization and Assessment of Impacts

PC. 2003. Remote Sensing Survey, Tidal Zone and Near Shore Project Area, Atlantic Coast of Long Island, Fire Island Inlet to Moriches Inlet, Fire Island, Suffolk County, New York, Interim Project, Final Report. Report prepared for U.S. Army Corps of Engineers by PC, Memphis TN.

William and Mary Center for Archaeological Research. 2016. Archaeological Survey and Assessment of Coastal Resources, Fire Island National Seashore, Suffolk County, New York. Report prepared for National Park Service by William and Mary Center for Archaeological Research, Williamsburg, VA.

5.4.6.3 Above Ground Historic Properties

Advisory Council on Historic Preservation (ACHP). 2004. 36 CFR 800 – Protection of Historic Properties - Special Requirements for Protecting National Historic Landmarks (36 CFR 800.10). <https://www.achp.gov/sites/default/files/regulations/2017-02/regs-rev04.pdf>. Accessed May 2020

Bureau of Ocean Energy Management (BOEM). 2020a. Guidelines for Providing Archaeological and Historical Property Information Pursuant to 30 CFR Part 585. United States Department of the Interior. Washington, D.C. <https://www.boem.gov/sites/default/files/documents/about-boem/Archaeology%20and%20Historic%20Property%20Guidelines.pdf>. Accessed August 2020.

BOEM. 2020b. OCS EIS/EA, BOEM 2020-025, Vineyard Wind 1 Offshore Wind Energy Project, Supplement to the Draft Environmental Impact Statement, June 2020. United States Department of the Interior, Washington, D.C. <https://www.boem.gov/sites/default/files/documents/renewable-energy/Vineyard-Wind-1-Supplement-to-EIS.pdf>. Accessed August 2020.

Environmental Design & Research, Landscape Architecture, Engineering & Environmental Services, D.P.C. (EDR). 2019. Visual Impact Assessment (Revised), South Fork Wind Farm, New York/Rhode Island, US. April 2019. 361 p.

National Park Service (NPS). 2018. Fire Island National Seashore, New York—Park Statistics. <https://www.nps.gov/fiis/learn/management/statistics.htm>. Accessed August 2020.

NPS. 2020. NPS Stats—Park Reports: Fire Island NS (FIIS). <https://irma.nps.gov/STATS/Reports/Park/FIIS>. Accessed August 2020.

Wood, S., J. Purdum, and B. Egan. 2017. Visualization Simulations for Offshore Massachusetts and Rhode Island Wind Energy Area. Herndon (VA): U.S. Department of the Interior, Bureau of Ocean Energy Management. OCS Study BOEM 2017-037. 134p.

5.4.7 Socioeconomic Resources

5.4.7.1 Employment, Economics, and Demographics

Bureau of Economic Analysis (BEA). 2018. Local Area Personal Income: New Estimates for 2017; Comprehensive Updates for 2001-2016: BEA 18-63. November 15, 2018. U.S. Department of Commerce. https://www.bea.gov/system/files/2018-11/lapi1118_0.pdf. Accessed August 6, 2019 and April 16, 2020.

CONSTRUCTION AND OPERATIONS PLAN

References – Section 4 – Site Characterization and Assessment of Impacts

- BEA. 2019. Gross Domestic Product by State: First Quarter of 2019: BEA 19-37. July 25. U.S. Department of Commerce. <https://www.bea.gov/system/files/2019-07/qgdpstate0719.pdf>.
<https://www.arcgis.com/apps/webappviewer/index.html?id=1700e1cf7228491d962973edc9924484>. Accessed August 6, 2019 and April 30, 2020.
- Connecticut Department of Labor. 2018. Labor Force Monthly Data w/ Annual Averages by County (2018). <https://www1.ctdol.state.ct.us/lmi/laus/lauscty.asp>. Accessed August 6, 2019.
- ICF Incorporated, LLC (ICF). 2012. Atlantic Region Wind Energy Development: Recreation and Tourism Economic Baseline Development. Impacts of Offshore Wind on Tourism and Recreation Economies. OCS Study. BOEM 2012-085. September.
- Massachusetts Executive Office of Labor and Workforce Development. 2019. Labor Force and Unemployment Data. http://lmi2.detma.org/lmi/lmi_lur_a.asp. Accessed August 12, 2019.
- New York State Department of Labor. 2019. Labor Area Unemployment Statistics Program. <https://labor.ny.gov/stats/lslaus.shtm>. <https://portofnewbedford.org/the-new-bedford-port-authority/>. Accessed August 12, 2019 and April 14, 2020.
- Rhode Island Department of Labor and Training. 2019a. Rhode Island Labor Force Statistics (Not Seasonally Adjusted), 1976 - Present. <http://www.dlt.ri.gov/lmi/laus/state/unadj.htm>. Accessed August 6, 2019.
- Rhode Island Department of Labor and Training. 2019b. Providence County Labor Force Statistics. <http://www.dlt.ri.gov/lmi/pdf/towns/providencecounty.pdf>. Accessed August 6, 2019.
- Rhode Island Department of Labor and Training. 2019c. Washington County Labor Force Statistics. <http://www.dlt.ri.gov/lmi/pdf/towns/washingtoncounty.pdf>. Accessed August 6, 2019.
- U.S. Bureau of Labor Statistics (BLS). 2019. Local Area Unemployment Statistics. <https://www.bls.gov/lau/>. Accessed April 16, 2020.
- BLS. 2020. Labor Force Data by County, 2018 Annual Averages. <https://www.bls.gov/lau/laucnty18.txt>. Accessed April 16, 2020.
- U.S. Census Bureau (USCB). 2000. DP-1: Profile of General Demographic Characteristics: 2000. Census 2000 Summary File 1 (SF 1) 100-Percent Data. <https://factfinder.census.gov/faces/nav/jsf/pages/index.xhtml>. Accessed July 25, 2019.
- USCB. 2010. DP-1: Profile of General Population and Housing Characteristics: 2010. 2010 Demographic Profile Data. <https://factfinder.census.gov/faces/nav/jsf/pages/index.xhtml>. Accessed July 25, 2019.
- USCB. 2017. American Community Survey and Puerto Rico Community Survey 2017 Subject Definitions. https://www2.census.gov/programs-surveys/acs/tech_docs/subject_definitions/2017_ACSSubjectDefinitions.pdf. Accessed July 26, 2019.

CONSTRUCTION AND OPERATIONS PLAN

References – Section 4 – Site Characterization and Assessment of Impacts

- USCB. 2018a. 2014-2018 American Community Survey 5-Year Estimates. Prepared by Social Explorer. socialexplorer.com. Accessed April 8, 2020.
- USCB. 2018b. B25004: Vacancy Status. 2014-2018 American Community Survey 5-Year Estimates. Prepared by Social Explorer. socialexplorer.com. Accessed April 16, 2020.
- USCB. 2018c. B25075: Value - Universe: Owner-occupied housing units. 2014-2018 American Community Survey 5-Year Estimates. Prepared by Social Explorer. <https://socialexplorer.com>. Accessed April 16, 2020.
- USCB. 2019. Quick Facts. <https://www.census.gov/quickfacts>. Accessed April 13, 2020.
- #### 5.4.7.2 Public Services
- Albany County. 2018. Multi-Jurisdictional Multi-Hazard Mitigation Plan for the County of Albany, New York. <https://www.albanycounty.com/home/showdocument?id=1182>. Accessed April 22, 2020.
- American Hospital Directory. 2020. Identification and Characteristics. <https://www.ahd.com/>. Accessed April 22, 2020.
- Baltimore County. 2019. Emergency Operations Plan for the County of Baltimore, Maryland. http://resources.baltimorecountymd.gov/Documents/Emergency_Op/eop.pdf. Accessed April 22, 2020.
- City of Hampton, Virginia. 2019. Hampton Roads Hazard Mitigation Plan for Hampton, Virginia. <https://www.hrpdcva.gov/library/view/620/2017-hampton-roads-hazard-mitigation-plan-and-appendices/>. Accessed April 22, 2020.
- City of New Bedford. 2016. Local Multi-Hazard Mitigation Plan Update for the City of New Bedford, Massachusetts. http://s3.amazonaws.com/newbedford-ma/wp-content/uploads/sites/28/20191219200617/New-Bedford_MA-HMP-Final-052516.pdf. Accessed April 22, 2020.
- City of New London and Milone & MacBroom, Inc. (New London and Milone). 2017. Hazard Mitigation Plan Update Annex for the City of New London; Southeastern Connecticut Council of Governments Multi-Jurisdictional Hazard Mitigation Plan Update. December.
- City of Providence Local Hazard Mitigation Committee and the Horsley Witten Group, Inc. (PLHMC and Horsley). 2019. Draft - Strategy for Reducing Risks from Natural and Human Caused Hazards in Providence, Rhode Island: A Multi-Hazard Mitigation Plan.
- Gloucester County. 2009. Multi-Jurisdictional Hazard Mitigation Plan Local Multi-Hazard Mitigation in Gloucester County, New Jersey. <http://www.co.gloucester.nj.us/depts/e/emeresponse/default.asp>. Accessed April 22, 2020.
- New York City. 2019. NYC's Landscape: A Guide to Hazard Mitigation for the City of New York. <https://nychazardmitigation.com/about/>. Accessed July 13, 2020.
- North Kingstown Hazard Mitigation Committee and the Rhode Island Emergency Management Agency (North Kingstown and RIEMA). 2013. Strategy for Reducing Risks from Natural Hazards in North Kingstown, Rhode Island: A Multi-Hazard Mitigation Strategy 2013, 5-Year Update.

CONSTRUCTION AND OPERATIONS PLAN

References – Section 4 – Site Characterization and Assessment of Impacts

- North Kingstown Police Department (North Kingstown PD). 2019. Our Mission. <http://northkingstown.org/301/Our-Mission>. Accessed April 22, 2020.
- State of Connecticut and Milone & MacBroom, Inc. (Connecticut and Milone). 2015. Preliminary Design Report, State Pier Complex Improvements, New London, Connecticut. http://ctportauthority.com/wp-content/uploads/2017/05/state_pier_preliminary_design_report_april_2015.pdf. Accessed April 22, 2020.
- State of New Jersey. 2019. Hazard Mitigation Plan for the State of New Jersey. <http://ready.nj.gov/mitigation/2019-mitigation-plan.shtml>. Accessed April 22, 2020.
- Suffolk County. 2018. Suffolk County Comprehensive Management Plan in Suffolk County, New York. <https://www.suffolkcountyny.gov/Portals/0/FormsDocs/fres/CEMPWD/CEMP%202018.pdf>. Accessed April 22, 2020.
- Town of Narragansett. 2019. Strategy for Reducing Risks from Natural Hazards in Narragansett, Rhode Island: A Multi-Hazard Mitigation Strategy. <https://www.narragansettri.gov/DocumentCenter/View/8132/Narragansett---2019-Hazard-Mitigation-Plan?bidId=>. Accessed April 22, 2020.
- Turmelle, L. 2019. Conn. Port Authority picks New Haven Harbor terminal operator to run New London Pier. <https://www.nhregister.com/business/article/Conn-Port-Authority-picks-New-Haven-Harbor-13515722.php>. Accessed April 22, 2020.
- #### 5.4.7.3 Recreation and Tourism
- Block Island Ferry. 2020. Block Island Wind Farm Tours. <http://biwindfarmtours.com>. Accessed May 27, 2020.
- Bloeser, J., C. Chen, M. Gates, A. Lipsky, and K. Longley-Wood. 2015. Ocean Planning in the Northeast-Characterization of Coastal and Marine Recreational Activity in the U.S. Northeast: A Report developed by Point 97, SeaPlan, and the Surfrider Foundation for the Northeast Regional Planning Body. http://archive.neoceanplanning.org/wp-content/uploads/2015/10/Recreation-Study_Final-Report.pdf. Accessed April 30, 2020.
- Bolger, Timothy. 2016. A Beginner's Guide to Summer on Fire Island. Long Island Press. <https://www.longislandpress.com/2016/05/21/a-beginners-guide-to-summer-on-fire-island/>. Accessed May 7, 2020.
- ICF Incorporated, LLC (ICF). 2012. Atlantic Region Wind Energy Development: Recreation and Tourism Economic Baseline Development. Impacts of Offshore Wind on Tourism and Recreation Economies. OCS Study. BOEM 2012-085. September.
- INSPIRE Environmental (INSPIRE). 2017. Hard Bottom Post-Construction Surveys, Year 1 Report for 2016 Summer Post-Construction Surveys to Characterize Potential Impacts and Response of Hard Bottom Habitats to Anchor Placement at the Block Island Wind Farm. Prepared for Deepwater Wind Block Island LLC.
- Martha's Vineyard Online. 2019. Traveling to Martha's Vineyard. <https://mvol.com/articles/traveling-marthas-vineyard/>. Accessed April 24, 2020.

CONSTRUCTION AND OPERATIONS PLAN

References – Section 4 – Site Characterization and Assessment of Impacts

- National Park Service (NPS). 2018. Fire Island National Seashore New York. <https://www.nps.gov/fiis/learn/historyculture/fire-island-lighthouse-history.htm>. Accessed May 7, 2020.
- NPS. 2019. National Park Service Visitor Use Statistics. <https://irma.nps.gov/Stats/>. Accessed August 12, 2019.
- New York State (NYS). 2017. New York Ocean Action Plan: 2017-2027. https://www.dec.ny.gov/docs/fish_marine_pdf/nyoceanactionplan.pdf. Accessed April 30, 2020.
- New York State Department of State (NYSDOS). 2017. New York State Coastal Management Program and Final Environmental Impact Statement. https://www.dos.ny.gov/opd/programs/pdfs/NY_CMP.pdf. Accessed April 24, 2020.
- New York State Energy Research and Development Authority (NYSERDA). 2017. New York State Offshore Wind Master Plan: Marine Recreational Uses Study. <https://www.nyserdas.ny.gov/-/media/Files/Publications/Research/Biomass-Solar-Wind/Master-Plan/17-25m-Marine-Recreational-Uses-Study.pdf>. Accessed June 10, 2020.
- Northeast Regional Ocean Council. 2014. Northeast Ocean Data. <https://www.northeastoceandata.org/data-explorer/?recreation|boating>. Accessed May 28, 2020.
- Rhode Island Coastal Resources Management Council (RI CRMC). 2010. Rhode Island Ocean Special Area Management Plan. Adopted by the RI CRMC on October 19, 2010. <http://seagrant.gso.uri.edu/oceansamp/documents.html>. Accessed October 12, 2019.
- SeaPlan. 2013. 2012 Northeast Recreational Boater Survey: A Socioeconomic and Spatial Characterization of Recreational Boating in Coastal and Ocean Waters of the Northeast United States. Technical Report. December. Doc #121.13.10. Boston. p. 105. <https://www.openchannels.org/sites/default/files/literature/2012%20Northeast%20Recreational%20Boater%20Survey.pdf>. Accessed July 12, 2019.
- SeaPlan. 2015a. Distance Sailing Races, Northeast United States. Northeast Regional Ocean Council, Northeast Ocean Data Portal. September.
- SeaPlan. 2015b. Recreational SCUBA Diving Areas, Northeast United States. Northeast Regional Ocean Council, Northeast Ocean Data Portal. September.
- U.S. Fish and Wildlife Service (USFWS). 2019. Refuge Finder. <https://www.fws.gov/refuges/>. Accessed August 12, 2019.
- #### 5.4.7.4 Other Marine Uses and Coastal Land Use
- 1st Line Defense. 2018. UXO Risk Assessment. <https://www.1stlinedefence.co.uk/wp-content/uploads/sites/55/2018/04/1LD-Datasheet-Detailed-UXO-Risk-Assessment.pdf>.
- Albany County. 2020. Albany County Interactive Mapping. <https://cha.maps.arcgis.com/apps/webappviewer/index.html?id=e9b0266f05aa4fe3aa2ed8a53af55481/>.
- Baltimore County. 2020. Baltimore County Government Emergency Operations.

CONSTRUCTION AND OPERATIONS PLAN

References – Section 4 – Site Characterization and Assessment of Impacts

- Bureau of Ocean Energy Management (BOEM). 2012. Commercial Wind Lease Issuance and Site Assessment Activities on the Atlantic Outer Continental Shelf Offshore Rhode Island and Massachusetts Environmental Assessment. https://www.boem.gov/sites/default/files/uploadedFiles/BOEM/Renewable_Energy_Program/State_Activities/BOEM_RI_MA_EA_2012-070_719.pdf
- BOEM. 2018. Intergovernmental Renewable Energy Task Force Meeting on The New York Bight. <https://www.boem.gov/renewable-energy/state-activities/intergovernmental-renewable-energy-task-force-meeting-new-york-0>.
- BOEM. 2018. Methodology for Analyzing the Effects of the Block Island Wind Farm (BIWF) on Rhode Island Recreation and Tourism Activities. U.S. Department of the Interior Bureau of Ocean Energy Management, Office of Renewable Energy Programs Environmental Studies Program. https://epis.boem.gov/final%20reports/BOEM_2018-068.pdf. Accessed February 27, 2020.
- BOEM. 2019. Environmental Studies Program: Ongoing Study. <https://www.boem.gov/sites/default/files/documents/environment/environmental-studies/AT-19-x09.pdf>.
- BOEM. 2021. New York Bight Intergovernmental Renewable Energy Task Force Meeting; April 14 and 16, 2021. Materials available at New York Bight Task Force Virtual Meeting Room. [New York Bight Task Force Virtual Meeting Room | Bureau of Ocean Energy Management \(boem.gov\)](https://www.boem.gov/new-york-bight-task-force-virtual-meeting-room)
- City of Providence. 2014. Zoning Ordinance User's Manual. <https://www.providenceri.gov/efile/5786.pdf>. Accessed October 11, 2019.
- City of Providence. 2019. Where's My Parcel and What's My Zone. <https://www.arcgis.com/apps/webappviewer/index.html?id=1700e1cf7228491d962973edc9924484>.
- Liquori, L, and I. Nagle. 2005. Town of East Hampton Comprehensive Plan [May 6, 2005]. Prepared for the East Hampton Town Board and Planning Department.
- Massachusetts Department of Fish and Game, Division of Marine Fisheries (MADMF). 2013. 2013 Annual Report. Accessed July 2020. <https://www.mass.gov/files/documents/2017/08/30/2013-dmf-annual-report.pdf>
- New York State. 2020. Department of Taxation and Finance. <https://www.tax.ny.gov/research/property/assess/manuals/prclas.htm>.
- New York State Energy Research and Development Authority. 2019. 2019 Announcements. <https://www.nyserda.ny.gov/About/Newsroom/2019-Announcements/2019-12-19-NYSERDA-Announces-Millions-Available-for-Pre-Development-Data-Collection-to-Support-Environmentally-Responsible-and-Cost-Effective-Offshore-Wind-Energy-Growth-in-New-York>.
- Port of New Bedford. 2020a. Marine Commerce Terminal. <https://portofnewbedford.org/marine-commerce-terminal/>. Accessed February 27, 2020.

CONSTRUCTION AND OPERATIONS PLAN

References – Section 4 – Site Characterization and Assessment of Impacts

- Port of New Bedford. 2020b. Offshore Wind. <https://portofnewbedford.org/offshore-wind/>. Accessed February 27, 2020.
- Port of New Bedford. 2020c. New Bedford Port Authority. <https://portofnewbedford.org/the-new-bedford-port-authority/>. Accessed February 27, 2020.
- State of Connecticut Department of Transportation. 2020. State Pier Property Characteristics Handout. https://portal.ct.gov/-/media/DOT/documents/dcommunications/MajorProjectUpdates/State_Pier_Property_Characteristics_handout1.pdf.
- Town of Brookhaven, New York. 2020. Public Information. <https://www.brookhavenny.gov/638/Public-Information>.
- Town of Coeymans. 2020. Albany County, New York Existing Zoning Map. <https://coeymans.org/wp-content/uploads/2016/08/02-existing-zoning-map-am.pdf>.
- Town of Narragansett. 2020. GIS and Maps. <https://www.narragansettri.gov/96/GIS-Maps>.
- Tradeport Atlantic. 2020. <https://www.tradeportatlantic.com/>.
- U.S. Army Corps of Engineers (USACE). 2014. Fire Island to Moriches Inlet Fire Island Stabilization Project. https://www.nan.usace.army.mil/Portals/37/docs/civilworks/projects/ny/coast/fimp/FIML_Docs/HSLRR/Appendix_E_Final_FI_Borrow_Area_Appendix_Jun2014.pdf.
- USACE New York District. 2020. FACT SHEET-Fire Island to Montauk Point, NY. Hurricane and Storm Damage Reduction <https://www.nan.usace.army.mil/Media/Fact-Sheets/Fact-Sheet-Article-View/Article/487483/fact-sheet-fire-island-to-montauk-point/>.
- Woods Hole Oceanographic Institution (WHOI). Winter 2019-2020. Autonomous Real-time Marine Mammal Detections, Cox Ledge. http://dcs.whoi.edu/cox1219/cox1219_we16.shtml
- #### 5.4.7.5 Commercial and Recreational Fisheries
- AKRF, Inc., AECOM, and A. Popper. 2012. Essential Fish Habitat Assessment for the Tappan Zee Hudson River Crossing Project.
- Atlantic Coastal Cooperative Statistics Program (ACCSP). 2019. Data Warehouse, Non-Confidential Commercial Landings, Summary; using Data Warehouse [online application], Arlington, VA. Available at <https://www.accsp.org>; Public Data Warehouse. Accessed June 2019.
- Bergström, L., F. Sundqvist, and U. Bergström. 2013. Effects of an offshore wind farm on temporal and spatial patterns in the demersal fish community. *Marine Ecology Progress Series*. Vol. 485: 199–210.
- Bergström, L., L. Kautsky, T. Malm, R. Rosenberg, M. Wahlberg, N.Å. Capetillo, and D. Wilhelmsson. 2014. Effects of offshore wind farms on marine wildlife – a generalized impact assessment. *Environmental Research Letters* 9: 1–12.
- Bureau of Ocean Energy Management (BOEM). 2013. Notice of Availability for the Commercial Wind Lease Issuance and Site Assessment Activities on the Atlantic Outer Continental

CONSTRUCTION AND OPERATIONS PLAN

References – Section 4 – Site Characterization and Assessment of Impacts

- Shelf Offshore Rhode Island and Massachusetts Environmental Assessment. Federal Register, Vol. 77, Docket No. BOEM-2013-13199.
- BOEM. 2019. Guidelines for Providing Information on Fisheries for Renewable Energy Development on the Atlantic Outer Continental Shelf Pursuant to 30 CFR Part 585. June 2019.
- BOEM Office of Renewable Energy Programs. 2020. Guidelines for Providing Information on Fisheries Social and Economic Conditions for Renewable Energy Development on the Atlantic Outer Continental Shelf Pursuant to 30 CFR Part 585. May 27, 2020.
- BOEM. 2021. Guidelines for Lighting and Marking of Structures Supporting Renewable Energy Development. Available online at: <https://www.boem.gov/2021-lighting-and-marking-guidelines>. Accessed May 25, 2021.
- Cheesman, S. 2016. Measurements of operational wind turbine noise in UK waters. In *The Effects of Noise on Aquatic Life II*. A. Popper and A. D. Hawkins eds. pp. 153-160.
- Collie, J.S., A.D. Wood, and H.P. Jeffries. 2008. Long-term shifts in the Species Composition of a Coastal Fish Community. *Canadian Journal of Fisheries and Aquatic Sciences* 65:1352–1365.
- Copping A., N. Sather, L. Hanna, J. Whiting, G. Zydlewski, G. Staines, A. Gill, I. Hutchison, A. O'Hagan, T. Simas, J. Bald, C. Sparling, J. Wood, and E. Masden. 2016. Annex IV 2016 State of the Science Report: Environmental Effects of Marine Renewable Energy Development Around the World.
- Germano, J., J. Parker, and J. Charles. 1994. Monitoring cruise at the Massachusetts Bay Disposal Site, August 1990. DAMOS Contribution No. 92. U.S. Army Corps of Engineers, New England Division. Waltham, Massachusetts.
- Greater Atlantic Region Fisheries Office (GARFO). 2016. GARFO Acoustic Tool: Analyzing the effects of pile driving on ESA-listed species in the Greater Atlantic Region. Accessed June 2020.
<http://www.greateratlantic.fisheries.noaa.gov/protected/section7/guidance/consultation/index.html>.
- Guida, V., A. Drohan, H. Welch, J. McHenry, D. Johnson, V. Kentner, J. Brink, D. Timmons, and E. Estela-Gomez. 2017. Habitat Mapping and Assessment of Northeast Wind Energy Areas. OCS Study BOEM 2017-088. US Department of the Interior, Bureau of Ocean Energy Management: Sterling, VA. 312 pp.
- Hare, J.A., W.E. Morrison, M.W. Nelson, M.M. Stachura, E.J. Teeters, et al. 2016. A vulnerability assessment of fish and invertebrates to climate change on the northeast U.S. continental shelf. *PLOS One* DOI:10/1371/journal.pone.0146756.
- HDR. 2019. Field Observations during Wind Turbine Operations at the Block Island Wind Farm, Rhode Island. Final Report to the U.S. Department of the Interior, Bureau of Ocean Energy Management, Office of Renewable Energy Programs. OCS Study BOEM 2019-028. 281pp.
- Hutchison, Z.L., P. Sigray, H. He, A.B. Gill, J. King, and C. Gibson, 2018. Electromagnetic Field (EMF) Impacts on Elasmobranch (shark, rays, and skates) and American Lobster Movement

CONSTRUCTION AND OPERATIONS PLAN

References – Section 4 – Site Characterization and Assessment of Impacts

- and Migration from Direct Current Cables. Sterling (VA): U.S. Department of the Interior, Bureau of Ocean Energy Management. OCS Study BOEM 2018-003.
- Hutchison, Z.L., A.B. Gill, P. Sigray, H. He, and J.W. King. 2020. Anthropogenic electromagnetic fields (EMF) influence the behaviour of bottom-dwelling marine species. Scientific Reports DOI:10.1038/s41598-020-60793-x
- Kenny, A.J. and H.L. Rees. 1994. The effects of marine gravel extraction on the macrobenthos: Early postdredging recolonization. *Marine Pollution Bulletin* 28: 442–447.
- Kirkpatrick, A., S. Benjamin, G. DePiper, T. Murphy, S. Steinback, and C. Demarest. 2017. Socio-Economic Impact of Outer Continental Shelf Wind Energy Development on Fisheries in the US Atlantic: Volume I - Report Narrative. Report by Bureau of Ocean Energy Management. p. 154.
- Kleisner, K.M., M.J. Fogarty, S. McGee, J.A. Hare, S. Moret, C.T. Perretti, and V.S. Saba. 2017. Marine species distribution shifts on the US Northeast Continental Shelf under continued ocean warming. *Progress in Oceanography* 153: 24-36.
- Kuffner, A. 2018. Wind star born in R.I. Deepwater Wind leads way in offshore generation. *The Providence Journal*. October 30, 2016. Section: Business; p. B1.
- Lindeboom, H.J., H.J. Kouwenhoven, M.J.N. Bergman, S. Bouma, S. Brasseur, R. Daan, R.C. Fijn, D. de Haan, S. Dirksen, R. van Hal, R. Hille Ris Lambers, R. ter Hofstede, K.L. Krijgsveld, M. Leopold, and M. Scheidat. 2011. Short-term ecological effects of an offshore wind farm in the Dutch coastal zone; a compilation. *Environmental Research Letters* 6: 1-13.
- Lovell, S., J. Hilger, E. Rollins, N.A. Olsen, and S. Steinback. 2020. The Economic Contribution of Marine Angler Expenditures on Fishing Trips in the United States, 2017. U.S. Dep. Commerce, NOAA Tech. Memo. NMFS-F/SPO-201. 80 p.
- McBride, R.S., M.K. Tweedie, and K. Oliveira. 2018. Reproduction, first-year growth, and expansion of spawning and nursery grounds of black sea bass (*Centropristis striata*) into a warming Gulf of Maine. *Fishery Bulletin* 116: 323-336.
- McManus, M.C., J.A. Hare, D.E. Richardson, and J.E. Collie. 2018. Tracking shifts in Atlantic mackerel (*Scomber scombrus*) larval habitat suitability on the Northeast U.S. continental shelf. *Fisheries Oceanography* 27: 49-62.
- National Oceanic and Atmospheric Administration (NOAA Fisheries). 2017a. Fisheries Economics of the United States, 2015. U.S. Department of Commerce, National Marine Fisheries Service, NOAA Tech Memo. NMFS-F/SPO-170, 247p.
- NOAA Fisheries. 2017b. Regional Fishery Management Councils. National Marine Fisheries Service. <http://www.nmfs.noaa.gov/sfa/management/councils/index.html>. Accessed October 4, 2017.
- NOAA Fisheries. 2018. Fisheries of the United States, 2017. U.S. Department of Commerce, NOAA Current Fishery Statistics No. 2017 <https://www.fisheries.noaa.gov/feature-story/fisheries-united-states-2017>.

CONSTRUCTION AND OPERATIONS PLAN

References – Section 4 – Site Characterization and Assessment of Impacts

- NOAA Fisheries. 2019. Recreational Fisheries Statistics Queries. Office of Science and Technology, Marine Recreational Information Program.
<https://www.st.nmfs.noaa.gov/SASStoredProcess/do?> Accessed on May 24, 2019.
- New York State Department of Environmental Conservation (NYSDEC). 2020. Aquaculture map request.
<https://nysdec.maps.arcgis.com/apps/webappviewer/index.html?id=d98abc91849f4ccf8c38dbb70f8a0042>.
- New York State Energy and Research and Development Authority (NYSERDA). 2017. New York State Offshore Wind Master Plan Fish and Fisheries Study Final Report. Prepared by Ecology and Environment Engineering, P.C. New York, New York. NYSERDA Report 17-25j. 202 pp.
- Northeast Regional Ocean Council (NROC). 2019. Aquaculture, Northeast United States.
<https://www.northeastoceandata.org/files/metadata/Themes/Aquaculture/Aquaculture.pdf>. Accessed August 2019.
- Nye, J.A., J.S. Link, J.A. Hare, and W.J. Overholtz. 2009. Changing spatial distribution of fish stocks in relation to climate and population size on the Northeast United States continental shelf. *Marine Ecology Progress Series* 393:111-129.
- Pinsky, M.L., B. Worm, M.J. Fogarty, J.L. Sarmiento, and S.A. Levin. 2013. Marine taxa track local climate velocities. *Science* 341:1239-1242.
- Popper, A.N., A.D. Hawkins, R.R. Fay, D. Mann, S. Bartol, T. Carlson, S. Coombs, W.T. Ellison, R. Gentry, M.B. Halvorsen, and S. Løkkeborg. 2014. *Sound Exposure Guidelines for Fishes and Sea Turtles*. A Technical Report prepared by ANSI-Accredited Standards Committee S3/SC1 and registered with ANSI. ASA S3/SC1. 4 TR-2014.
- Rhode Island Coastal Resources Management Council (RICRMC). 2010. Rhode Island Ocean Special Area Management Plan. Adopted by the Rhode Island CRMC on October 19, 2010. <http://seagrant.gso.uri.edu/oceansamp/documents.html>. Accessed May 31, 2017.
- Rhode Island Department of Environmental Management (RIDEM). 2017. Spatiotemporal and Economic Analysis of Vessel Monitoring System Data within Wind Energy Areas in the Greater North Atlantic. Department of Marine Fisheries.
http://www.dem.ri.gov/programs/bnatres/fishwild/pdf/RIDEM_VMS_Report_2017.pdf. Accessed August 2019.
- Richardson, W.J., C.R. Greene, C.I. Malme, and D.H. Thomson. 1995. *Marine Mammals and Noise*. San Diego, California: Academic Press.
- Saba, V.S., S.M. Griffies, W.G. Anderson, M. Winton, M.A. Alexander, T.L. Delworth, and R. Zhang. 2016. Enhanced warming of the Northwest Atlantic Ocean under climate change. *Journal of Geophysical Research-Oceans*, 121(1), 118-132.
- Scotti, J., J. Stent, and K. Gerbino. 2017. New York Commercial Fisherman Ocean Use Mapping. Prepared by the Cornell Cooperative Extension Marine Program for New York State Department of State. Final Report. 65 pp.

CONSTRUCTION AND OPERATIONS PLAN

References – Section 4 – Site Characterization and Assessment of Impacts

- Selden, R.L., R.D. Batt, V.S. Saba, and M.L. Pinsky. 2018. Diversity in thermal affinity among key piscivores buffers impacts of ocean warming on predator-prey interactions. *Global Change Biology*, 24(1), 117-131.
- Snyder, J., Whitney, M.M., Dam, H. Jacobs, M.W., and H. Baumann. 2019. Citizen science observations reveal rapid, multi-decadal ecosystem changes in eastern Long Island Sound. *Marine Environmental Research* 146: 80-88.
- Sunrise Wind. 2019. Fisheries Mitigation Plan for Sunrise Wind. Version 1.0. prepared pursuant to Section 12.05 of the Offshore Wind Renewable Energy Certificate Purchase and Sale Agreement by and Between the New York State Energy Development and Research Authority and Sunrise Wind LLC dated October 23, 2019. Albany, NY. 28 pp.
- Taormina, B., J. Bald, A. Want, G. Thouzeau, M. Lejart, N. Desroy, and A. Carrier. 2018. A review of potential impacts of submarine power cables on the marine environment: Knowledge gaps, recommendations, and future directions. *Renewable and Sustainable Energy Reviews* 96: 380-391.
- Thomsen, F., K. Lüdemann, R. Kafemann, and W. Piper. 2006. Effects of offshore wind farm noise on marine mammals and fish. *biola*, Hamburg, Germany on behalf of COWRIE Ltd. 62 p.
- United States Coast Guard (USCG) 2020. The Areas Offshore of Massachusetts and Rhode Island Port Access Route Study. Final Report. Docket Number USCG-2019-0131. May 14, 2020. 199 p.
- Walsh, H.J., D.E. Richardson, K.E. Marancik, and J.A. Hare. 2015. Long-term changes in the distributions of larval and adult fish in the northeast U.S. shelf ecosystem. *PLoS ONE* 10:e0137382. doi:10.1371/journal.pone.0137382.
- Wilber, D.H. and D.G. Clarke. 1998. Estimating secondary production and benthic consumption in monitoring studies: A case study of the impacts of dredged material disposal in Galveston Bay, Texas. *Estuaries* 21: 230-245.

5.4.7.6 Environmental Justice

- Bureau of Ocean Energy Management (BOEM). 2013. Commercial Wind Lease Issuance and Site Assessment Activities on the Atlantic Outer Continental Shelf Offshore Rhode Island and Massachusetts, Revised Environmental Assessment. Office of Renewable Energy Programs. OCS EIS/EA. BOEM 2013-1131. May.
- Connecticut Department of Energy & Environmental Protection (CTDEEP). 2012. Environmental Justice Public Participation Fact Sheet. https://portal.ct.gov/-/media/DEEP/environmental_justice/EJfspdf.pdf?la=en. Accessed April 20, 2020.
- Council on Environmental Quality (CEQ). 1997. Environmental Justice: Guidance Under the National Environmental Policy Act. Washington, D.C.: Executive Office of the President. <https://ceq.doe.gov/docs/ceq-regulations-and-guidance/regs/ej/justice.pdf>. Accessed April 20, 2020.
- ESS Group. 2016. The Identification of Port Modifications and the Environmental and Socioeconomic Consequences. OCS Study BOEM 2016-034. April 15.

CONSTRUCTION AND OPERATIONS PLAN

References – Section 4 – Site Characterization and Assessment of Impacts

Maryland Department of Environment. 2020.

<https://mde.maryland.gov/programs/Crossmedia/EnvironmentalJustice/Pages/WhatisEJ.aspx>. Accessed April 22, 2020.

Massachusetts Department of Environmental Protection. 2020.

<https://www.mass.gov/environmental-justice>. Accessed April 22, 2020.

New Jersey Department of Environmental Protection (DEP) Office of Environmental Justice. 2020.

<https://www.nj.gov/dep/ej/>. Accessed April 22, 2020.

New York State Department of Environmental Conservation (NYSDEC). 2003. Commissioner Policy 29, Environmental Justice and Permitting.

<https://www.dec.ny.gov/regulations/36951.html>. Accessed April 20, 2020.

Rhode Island Department of Environmental Management (RIDEM). 2009. Policy for Considering Environmental Justice in the Review of Investigation and Remediation of Contaminated Properties. <http://www.dem.ri.gov/envequity/pdf/ejfinal.pdf>. Accessed November 8, 2018.

U.S. Census Bureau (USCB). 2018a. B17001: Poverty Status in the Past 12 Months by Sex by Age - Universe: Population for whom poverty status is determined. 2014-2018 American Community Survey 5-Year Estimates. Prepared by Social Explorer. socialexplorer.com. Accessed April 8, 2020.

USCB. 2018b. B03002 Hispanic or Latino Origin by Race. 2014-2018 American Community Survey 5-Year Estimates. Prepared by Social Explorer. socialexplorer.com. Accessed April 8, 2020.

Virginia Council on Environmental Justice. 2020.

<https://www.naturalresources.virginia.gov/initiatives/environmental-justice/>. Accessed April 22, 2020.

5.4.8 Transportation and Navigation

5.4.8.1 Marine Transportation and Navigation

BOEM. 2021. Guidelines for Lighting and Marking of Structures Supporting Renewable Energy Development. Available online at: <https://www.boem.gov/2021-lighting-and-marking-guidelines>. Accessed May 25, 2021.

BOEM and National Oceanic and Atmospheric Administration (NOAA). 2020.

MarineCadastre.gov. Various graphics from General Information, Oceanographic and Biophysical, and Transportation and Infrastructure.

https://www.marinecadastre.gov/oceanreports/@-8008078.13924283,4962189.958543951/11/eyJ0IjoiaGkiLCJiljoib2NIYW4iLCJmljowLCJzljowL_CJhIjoiiNWNmMDkzMjk3M2Y0YmQ3NmZhZGYwMzNINWE1Nzg0NDYiLCJsljpbMTAwMV19. Accessed May 2020.

International Association of Marine Aids to Navigation and Lighthouse Authorities (IALA). 2013. IALA Recommendation O-139 – The Marking of Man-Made Offshore Structures. Edition 2, December 2013. <https://www.iala-aism.org/product/markings-of-man-made-offshore-structures-o-139/>. Accessed July 2020.

CONSTRUCTION AND OPERATIONS PLAN

References – Section 4 – Site Characterization and Assessment of Impacts

- Mid-Atlantic Regional Council on the Ocean (MARCO), 2020. Mid-Atlantic Ocean Data Portal. Web portal: <http://portal.midatlanticocean.org/>. VTR data for from: <https://portal.midatlanticocean.org/data-catalog/fishing>. Accessed 10 March 2020.
- New York State Energy Research and Development (NYSERDA), 2017. New York State Offshore Wind Master Plan: Shipping and Navigation Study. NYSERDA Report 17-25q.
- Northeast Regional Ocean Council (NROC). 2018. Northeast Ocean Data: Data Explorer, Databases downloaded: annual data layers for vessel transit counts for years 2013, 2015, 2016, and 2017. <https://www.northeastoceandata.org/data-download/?data=Marine%20Transportation>. Accessed April 2020.
- United States Coast Guard (USCG). 2017. CG Mission Data 2006-2016 for Southfork wind farm area.
- USCG. 2018. Intergovernmental Renewable Energy Task force for the New York Bight. New York, 28 November 2018, George H. Detweiler, Jr., Office of Navigation Systems. <https://www.boem.gov/sites/default/files/renewable-energy-program/State-Activities/NY/NY-Bight-Fairways-Presentation.pdf>. Accessed July 2020.
- USCG. 2020. The Areas Offshore of Massachusetts and Rhode Island Port Access Route Study. Final Report, USCG-2019-0131.
- #### 5.4.8.2 Land Transportation and Navigation
- Metropolitan Transport Authority (MTA). 2012. Long Island Rail Road General Information. <http://web.mta.info/lirr/about/GeneralInformation/>. Accessed May 14, 2020.
- New York State Department of Transportation (NYSDOT). 2014. 2014 Traffic Data Report for New York State.
- NYSDOT. 2018. Traffic Volume Report – County Roads. Highway Data Services Bureau.
- Suffolk County Transit (SCT). 2012. Route Map. <https://sct-bus.org/sctmap.html>. Accessed May 14, 2020.
- #### 5.4.8.3 Air Transportation and Navigation
- BOEM. 2021. Guidelines for Lighting and Marking of Structures Supporting Renewable Energy Development. Available online at: <https://www.boem.gov/2021-lighting-and-marking-guidelines>. Accessed May 25, 2021.
- USCG. 2020. The Areas Offshore of Massachusetts and Rhode Island Port Access Route Study. Final Report, USCG-2019-0131.